

NOTICE OF
REINSTATEMENT

INCH-
POUND

MIL-STD-1797A
NOTICE 3
24 August 2004
SUPERSEDING
NOTICE 2
19 December 1997

DEPARTMENT OF DEFENSE
INTERFACE STANDARD

FLYING QUALITIES OF PILOTED AIRCRAFT

MIL-STD-1797A, dated 30 January 1990, is hereby reinstated and may be used for acquisition.

Custodians:
Army – AV
Navy – AS
Air Force – 11

Preparing activity:
Air Force – 11
(Project 15GP-0066)

NOTE: The activities listed above were interested in this document as of the date of this document. Since organizations and responsibilities can change, you should verify the currency of the information above using the ASSIST Online database at www.dodssp.daps.mil.

AMSC N/A

FSC 15GP

DISTRIBUTION STATEMENT A. Approved for public release; distribution is unlimited.

NOTICE OF
CANCELLATION

INCH-POUND

MIL-STD-1797A
NOTICE 2
19 December 1997

**DEPARTMENT OF DEFENSE
INTERFACE STANDARD**

**FLYING QUALITIES
OF
PILOTED AIRCRAFT**

MIL-STD-1797A, dated 30 January 1990, is hereby canceled. However, the technical information and the lessons learned from this standard have been preserved in MIL-HDBK-1797. MIL-HDBK-1797 is for guidance only and should not be cited as a requirement, but information in the handbook may be useful in determining or evaluating requirements.

Custodian:
Air Force - 11

Preparing Activity:
Air Force - 11

(Project 15GP-0043)

FSC 15GP

DISTRIBUTION STATEMENT A. Approved for public release; distribution is unlimited.

**NOTICE OF
CHANGE**

INCH-POUND

MIL-STD-1797A
NOTICE 1
28 June 1995

**DEPARTMENT OF DEFENSE
INTERFACE STANDARD

FLYING QUALITIES
OF
PILOTED AIRCRAFT**

TO ALL HOLDERS OF MIL-STD-1797A:

MAKE THE FOLLOWING PEN AND INK CHANGES:

Cover

Delete "Military Standard" and insert "Department of Defense Interface Standard." Delete entire Distribution Statement D and substitute: "Distribution Statement A. Approved for public release; distribution is unlimited."

Page ii

Delete entire Export Control Warning and Destruction Notice.

Page 9

3.4.6, bottom of page. Delete " $\Delta\beta$ " and substitute " $\Delta\beta_{\max}$ ".

Page 38

4.6.5.3, line 3, change to read: "system due to pilot action shall not exceed...".

Page 39

4.6.6.2, first sentence, change to read: "Yaw control power shall be sufficient...".

Page 58

20.3, sixth reference on page. Delete "MIL-F-25140" and substitute "MIL-W-25140".

DISTRIBUTION STATEMENT A. Approved for public release; distribution is unlimited.

AMSC N/A

FSC 15GP

MIL-STD-1797A
NOTICE 1

Page 80

3.2, Requirement Guidance, Category B, line 3. Delete "light-path" and substitute "flight-path".

Page 96

4.1.4.1, Requirement Guidance, d. Delete " $V_{o_{min}PA}$ " and substitute " $V_{o_{min}PA}$ ".

4.1.4.1, Requirement Guidance, d, lines 2, 3, 4. and 6. Delete " V_s " and substitute " V_S ".

Page 101

4.1.4.2, Requirement Guidance, 2.e, first line. Delete "what" and substitute "that".

Page 103

4.1.4.3, Requirement Guidance, next to last paragraph, line 3. Change to read: "...sea level while remaining...".

4.1.4.3, Requirement Guidance, next to last paragraph, line 7. Change to read: "... (commonly used for structural...".

Page 122

Figure 8, Change title to read: "Definition of Levels which include atmospheric disturbances as well as failures -Suggested by Carlson (AFFDL-TR-78-171)."

Page 137

5.1.11.2, Verification Guidance, last sentence. Change to read: "...will likely be at the boundaries of...".

Page 139

4.1.11.4, Requirement Guidance, line 2. Change to read: "Recommended minimum time delay: A default value would be 1 second."

4.1.11.4, Requirement Guidance, last sentence. Change to read: "Table IX and the paragraph following it are excerpts."

Page 144

4.1.11.5. Requirement Guidance, third paragraph, line 2. Delete " C_{1_p} " and substitute " C_{ℓ_β} ".

Page 146

5.1.11.5, Verification Guidance, third paragraph, lines 2 and 3. Change to read: "...To these margins must be added another nose-down control...".

5.1.11.5, Verification Guidance, last paragraph, line 2. Change to read: "needed: $\Delta\delta_{marg}$ is the sum of turbulence and sensor-wise components, $\Delta\delta_{tran}$ provides...".

Page 159

4.1.12. 11 line 3. Change to read: "...aircraft motion produced, be conveniently and ...".

**MIL-STD-1797A
NOTICE 1**

Page 160

4.1.12.4 through 4.1.12.11, Requirement Rationale, first line. Change to read: "...directly to the flight control system applies..."

Page 167

4.2.1.1, Requirement Guidance, Equation, last term in numerator. Change to read " $e^{-\tau_{es}s}$ ".

Page 169

4.2 through 4.2.1.1, Requirement Lessons Learned, third paragraph, line 1. Change to read "... angle of attack above that for zero $1/T_{h1}$ or $d\gamma/dV$. These..."

Page 175

4.2.1.2, Requirement Guidance, second and third expressions. Change to read:

$$\frac{M_{\delta} Z_w (1/T_{\theta_1})}{M_{\alpha} [\zeta_p; \omega_p]} \quad \text{and} \quad \frac{M_{\delta} (1/T_{\theta_2}) e^{-\tau_{\theta} s}}{s [\zeta_{sp}; \omega_{sp}]}$$

Phugoid Short Period

Page 177

4.2.1.2, Requirement Guidance, line 8. Change to read "...can be ignored, leaving the a_z/δ_{es} numerator..."

4.2.1.2, Requirement Guidance, last paragraph, line 4. Change to read "... (LOES) of the θ/F_{es} transfer function..."

Page 184

4.2.1.2, Requirement Guidance, last line. Change to read "...short-period approximation),".

Page 187

4.2.1.2, Requirement Guidance, line 2. Change to read "...and 16 ft \bar{c} , the specified Level 1..."

Page 194

Figure 25, approximately center of figure. Delete "15,2" and substitute "1.5,2".

Figure 25, legend box, P.R. Scale, second listing. Delete "COPPER-HARPER" and substitute "COOPER-HARPER".

Figure 25, title. Change to read: "Comparison of pilot ratings with Category A short-period frequency requirements."

Page 195

Figure 26, legend box, P.R. Scale, second listing. Delete "COPPER-HARPER" and substitute "COOPER-HARPER".

MIL-STD-1797A
NOTICE 1

Page 196

Figure 27, legend box, P.R. Scale, second listing. Delete "COPPER-HARPER" and substitute "COOPER-HARPER".

Page 197

Figure 29, legend box, P.R. Scale, second listing. Delete "COPPER-HARPER" and substitute "COOPER-HARPER".

Figure 29, right edge of figure. Delete "Boundaries from AGARD-CP-333" and substitute "Boundaries from AGARD-CP-333, Gibson".

Page 200

Figures 33 and 35, fourth diagonal line. Delete "LEVELS 2" and substitute "LEVEL 2".

Figure 35, legend in upper left hand corner, last line. Delete "4,000 43" and substitute "4,000 431".

Page 201

Figure 36. Rotate the figure 90 degrees counterclockwise.

Page 219

Next to last equation. Delete and substitute:

$$\frac{\omega_{sp}^2}{n/\alpha} = \frac{\ddot{\theta}_0}{n_{z_{ss}}} \cong \frac{q_{ss}/\Delta t}{q_{ss} V_T/g} - \frac{g}{V_T \Delta t}$$

Page 259

Frequency-response magnitude and phase, second equation under Exact: Delete and substitute:

$$\Phi = \pm \tan^{-1}(\tau\omega)$$

Page 260

Equation at bottom of page. Delete and substitute:

$$\zeta = \sqrt{K_q T_q M_\delta} / 2$$

Page 290

4.2.7.2.1, last sentence. Change to read: "...result in departure or exceedance of load factor units."

Page 294

4.2.7.3, Lessons Learned, pages 2 and 3. Change to read: "...It was possible to mis-set trim for takeoff so that -24 deg deflection ...".

MIL-STD-1797A
NOTICE 1

Page 303

Table XVII, last line of section a. Change to read: "** For $n_L < 3$, (F_s / n) max is 28.0..."

Page 305

Figure 101, center of figure, denominator, twice. Delete "(n/d)" and substitute "(n/α)".

Page 329

Table XV111, last column heading. Delete " d_{as}/F_{as} " and substitute " δ_{as}/F_{as} ".

Page 364

Figure 130, legend in lower right corner. Delete "REFERENCE AFFDL-TR-65-227" and "REFERENCE NASA-TND-2251" and substitute "AFFDL-TR-65-227" and "NASA-TND-2251".

Page 366

5.3.1.2, Verification Guidance, second line of equation. Delete "-sin (a+ i_t)" and substitute "-sin (α+ i_t)".

Page 375

4.4.1.1, Requirement Guidance, fifth paragraph, line 6. Change expression to read: " $(M^2 \cos^2 \Delta - 1)^{-1/2}$ ".

Page 377

4.5.1.1, Requirement Guidance, first equation following second paragraph. Change denominator in second part of equation to read: " $(1/T_S) (1/T_R) [\zeta_d, \omega_d]$ ".

4.5.1.1, Requirement Guidance, second equation following second paragraph. Change numerator in second part of equation to read: " $(A_3 s^3 + A_2 s^2 + A_1 s + A_0) e^{-\tau e \beta}$ ".

Page 391

First equation, last term, right hand side. Change to read: " $-2k_z^2 C_{L_1}$ ".

Page 398

Figure 150, title. Change to read: "Composite pilot ratings for spiral descent of simulated reentry vehicle (from NASA-CR-778)."

Page 402

5.5.1.3, Verification Guidance, two large equations in middle of page. Change the denominator inside the large parentheses of both equations to read:

$$1 - \frac{g_p b k_z^2}{4(W/S)k_x^2} \left(C_{y_\beta} + \frac{C'_{n_r}}{2k_z^2} \right) \frac{C'_{\ell_p}}{C'_{n_\beta}}$$

Page 404

4.5.1.4, Requirement Guidance. third paragraph, second line. Delete "figure 154" and substitute "figure 156".

MIL-STD-1797A
NOTICE 1

Page 418

Second equation. last term inside the square brackets on the right side.

Delete $-\frac{C_{y'_{\delta a}}}{C'_{\ell_{\delta a}}} C'_{\ell_{\beta}}$ and substitute $-\frac{C_{y_{\delta a}}}{C'_{\ell_{\delta a}}} C'_{\ell_{\beta}}$

Page 429

5.5.5, Verification Guidance, last equation, denominator. Change to read:

$$C_{\ell_{\delta a}} \left(1 - \frac{C_{n_{\delta a}} C_{\ell_{\delta r}}}{C_{\ell_{\delta a}} C_{n_{\delta r}}} \right)$$

Page 460

5.5.8.1, Verification Guidance, last two equations, bottom of page. Change to read:

$$k_x^2 = I_x / (mb^2), \quad k_z^2 = I_z / (mb^2),$$

Page 464

Lower right hand corner, top of second sketch. Delete "X" and substitute "x".

Page 466

4.5.8.4, Requirement Lessons Learned, line 2. Delete "YF-15" and substitute "YC-15".

4.5.8.4, Requirement Lessons Learned. Combine the two paragraphs into one paragraph.

Page 476

4.5.9.2, Requirement Guidance, fifth line following table. Change to read "Level 2: One-eighth of the Level 2 values in table XXXVI."

Page 491

4.5.9.3, Requirement Guidance, fifth line from bottom of the page. Delete "(AGARD-C-333)" and substitute "(AGARD-CP-333)".

Page 498

Matrix equation, middle of page. Change to read:

**MIL-STD-1797A
NOTICE 1**

$$\begin{bmatrix} C_{\ell_\beta} + \frac{bg}{2V_T^2} C_{y_\beta} \left[\frac{C_{\ell_r}}{C_{L_1}} - 4 \left(k_z^2 - k_y^2 \frac{\bar{c}^2}{b^2} \right) \sin \Phi \tan \Phi \right] \\ C_{n_\beta} + \frac{bg}{2V_T^2} C_{y_\beta} \left[\frac{C_{n_r}}{C_{L_1}} - 4k_{xz}^2 \sin \Phi \tan \Phi \right] \end{bmatrix} \begin{bmatrix} C_{\ell_{\delta_a}} \\ C_{n_{\delta_a}} \end{bmatrix} \begin{bmatrix} \beta \\ \delta_a \end{bmatrix} = \frac{bg}{V_T^2} \begin{bmatrix} -\frac{1}{2} C_{\ell_r} \sin \Phi + C_{L_1} \left(k_z^2 - k_y^2 \frac{\bar{c}^2}{b^2} \right) \sin^2 \Phi \tan \Phi \\ -\frac{1}{2} C_{n_r} \sin \Phi + C_{L_1} k_{xz}^2 \sin^2 \Phi \tan \Phi \end{bmatrix}$$

Sentence following the matrix equation. Change to read:

where $C_{L_1} = w / (\bar{q}S)$, $k_y^2 = I_y / (m\bar{c}^2)$, $k_z^2 = I_z / (mb^2)$, $k_x^2 z = I_{xz} / (mb^2)$, $n_y = C_{y_\beta} \beta / C_{L_1}$.

Page 504

4.5.9.5.7, Requirement Guidance, third paragraph, line 2. Delete "over look" and substitute "overlook".

Page 505

4.6.1.1, Requirement Guidance, second and third equations, first term in denominator. Change to read: "(s + 1/T_s)"

4.6.1.1, Requirement Guidance, first line following third equation. Change to read ".. deflection controls (pilot controller deflection commands ...)".

Page 526

5.6.1.1, Verification Guidance, fourth equation. Change to read:

$$2\zeta_d \omega_d \doteq -\frac{\rho V g}{2(W/S)} \left[C_{y_\beta} + \frac{1}{2k_z^2} C'_{n_r} - \frac{k_z^2}{k_x^2} \frac{C'_{\ell_\beta}}{C'_{n_\beta}} \left(C_{L_1} - \frac{1}{2k_z^2} C'_{n_p} \right) \right]$$

5.6.1.1, Verification Guidance, first and second sentences following last equation. Change to read " $|\phi / \beta|_d$ is the ratio of amplitudes of the roll and sideslip envelopes in the dutch roll mode and $C_{L_1} = w / (\bar{q}S)$. The dutch-roll envelope of roll rate, p, is shown in figure 228, from AFFDL-TR-69-72, for a step command."

Page 529

Last equation, numerator of last term. Change to read: $C_{y_{\delta_a}} (C_{\ell_\beta} - C_{n_\beta} C_{\ell_{\delta_r}} / C_{n_{\delta_r}})$.

**MIL-STD-1797A
NOTICE 1**

Page 545

4.6.2, Requirement Guidance, footnote 11, second sentence. Change to read: "The $\psi\beta$ and $\Delta\beta/k$ of figure 238..."

Page 546

Paragraph 3, line 3. Change to read: "... For $|\phi/\beta|_d$ above some nominal value ($\doteq 5.0$),..."

Page 552

Second line following figure. Change to read: "measurement of ϕ_1 . The above-noted trend..."

Page 572

5.6.4, Verification Guidance, first equation. Change to read: $-\delta_a/\delta_{rp} = C'_{\ell_{\delta r}}/C'_{\ell_{\delta a}}$

Page 578

5.6.5.1, Verification Guidance, last three equations. Change to read:

$$C_{y\beta}^* = C_{y\beta} - C_{y\delta_r} C_{hr\beta} / C_{hr\delta_r}$$

$$C_{n\beta}^* = C_{n\beta} - C_{n\delta_r} C_{hr\beta} / C_{hr\delta_r}$$

$$C_{\ell\beta}^* = C_{\ell\beta} - C_{\ell\delta_r} C_{hr\beta} / C_{hr\delta_r}$$

Page 581

5.6.6, Verification Guidance. equation. Change to read:

$$\bar{q} \text{ Sb} C_n(\delta_r, \delta_a, \delta T, \beta, \dot{\beta}, P, R, \alpha, M \dots) = I_z \dot{R} - I_{xz} (\dot{P} + QR) + (I_y - I_x) PQ$$

Page 584

4.6.6.2, first sentence. Change to read: "Yaw control power shall be sufficient to meet..."

Page 589

First equation, delete and substitute.

$$\begin{bmatrix} C_{y\beta} & 0 & C_{y\delta_r} \\ C_{\ell\beta} & C_{\ell\delta_a} & C_{\ell\delta_r} \\ C_{n\beta} & C_{n\delta_a} & C_{n\delta_r} \end{bmatrix} \begin{bmatrix} \beta \\ \delta_a \\ \delta_r \end{bmatrix} = \frac{g}{V} \cdot \frac{b}{2V} \cdot \sin\phi \cdot \begin{bmatrix} C_{y_p} \sin\theta/\cos\phi - C_{y_r} \cos\theta \\ C_{\ell_p} \sin\theta/\cos\phi - C_{\ell_r} \cos\phi + 2C_{L1} \cos\theta \sin\phi \tan\phi \left[\left(\frac{k_z^2 - k_y^2 \bar{c}^2}{b^2} \right) \cos\theta + k_{xz}^2 \sin\theta/\cos\phi \right] \\ C_{n_p} \sin\theta/\cos\phi - C_{n_r} \cos\theta + 2C_{L1} \cos\theta \sin\phi \tan\phi \left[\left(\frac{k_x^2 - k_y^2 \bar{c}^2}{b^2} \right) \sin\theta/\cos\phi + k_{xz}^2 \cos\theta \right] \end{bmatrix}$$

**MIL-STD-1797A
NOTICE 1**

Second equation, delete and substitute.

$$C_{L_1} = W / (\bar{q}S), \quad k_x^2 = I_x / (mb^2), \quad k_y^2 = I_y / (m\bar{c}^2), \quad k_z^2 = I_z / (mb^2), \quad k_{xz}^2 = I_{xz} / (mb^2)$$

First paragraph, line 4. Change to read "hand column $(0 \ C_2 \ C_3)^T$ (neglecting C_{y_p} and C_{y_r}),".

Fourth equation, delete and substitute.

$$\delta_a = \frac{g b \sin \Phi}{2V^2 \Delta} \left[C_2 (C_{y_\beta} C_{n_{\delta_r}} - C_{n_\beta} C_{y_{\delta_r}}) - C_3 (C_{y_\beta} C_{\ell_{\delta_r}} - C_{\ell_\beta} C_{y_{\delta_r}}) \right]$$

Page 603

Equation inside sketch. Delete "z = x tan ε" and substitute "-z = x tan ε".

4.8. 1, Requirement Lessons Learned . Switch the order of paragraphs 1 and 2.

Page 604

5.8.1, Verification Guidance, last sentence. Change to read: "...the critical roll rate squared, p_{cr}^2 , is".

Page 642

5.8.4.3.1, Verification Guidance, four equations, one-third of the page down from the top. Change to read:

$$L'_i = \frac{L_i + \frac{I_{xz}}{I_x} N_i}{1 - \frac{I_{xz}^2}{I_x I_z}}, \quad N'_i = \frac{N_i + \frac{I_{xz}}{I_z} L_i}{1 - \frac{I_{xz}^2}{I_x I_z}}, \quad C'_{\ell_i} = \frac{C_{\ell_i} + \frac{I_{xz}}{I_z} C_{n_i}}{1 - \frac{I_{xz}^2}{I_x I_z}}, \quad C'_{n_i} = \frac{C_{n_i} + \frac{I_{xz}}{I_x} C_{\ell_i}}{1 - \frac{I_{xz}^2}{I_x I_z}}$$

Page 664

Figure 266, top of figure. Close the gap in the line under the "h".

Page 665

Fourth and fifth equations. Delete and substitute:

$$\phi u_1 (\Omega) = \frac{200}{1 + (100\Omega)^2} \text{ (ft/sec)}^2 \text{ per rad/ft}$$

$$\phi v_1 (\Omega) = \frac{939 [1 + (400\Omega^2)]}{[1 + (1000\Omega)^2][1 + (400\Omega/3)^2]} \text{ (ft/sec)}^2 \text{ per rad/ft}$$

Page 667

First and second sentence following third equation. Delete and substitute:

where: ω_p = Ship pitch frequency, radians/second.

θ_s = Ship pitch amplitude, radians.

MIL-STD-1797A
NOTICE 1

Page 674

Table LVI, second column, fourth entry, line 4. Change to read: "components. High-frequency spectral".

Page 680

4.9.3, first equation. Delete and substitute:

$$- \dot{\alpha}_g = q_g = \frac{\partial W_g}{\partial x}, p_g = \frac{\partial W_g}{\partial y}, r_g = - \frac{\partial V_g}{\partial x}$$

Page 693

First row, fourth column. Change to read "iii. 1,687".

Second row, fourth column. Change to read "687".

Page 701

Column heading, fourth column. Change to read "PAGE NO. IN THIS DOCUMENT".

**MIL-STD-1797A
NOTICE 1**

2. THE FOLLOWING PAGES OF MIL-STD-1797A HAVE BEEN REVISED AND SUPERSEDE THE PAGES LISTED:

NEW PAGE	DATE	SUPERSEDED PAGE	DATE
iii	30 January 1990	iii	REPRINTED WITHOUT CHANGE
iv-xii	28 June 1995	iv-xxvii	30 January 1990
61	28 June 1995	61	REPRINTED WITHOUT CHANGE
62-75b	28 June 1995	62-75	30 January 1990
76	30 January 1990	76	REPRINTED WITHOUT CHANGE
107	30 January 1990	107	REPRINTED WITHOUT CHANGE
108-108q	28 June 1995	108	30 January 1990
109	28 June 1995	109	30 January 1990
110	30 January 1990	110	REPRINTED WITHOUT CHANGE
149	28 June 1995	149	30 January 1990
150	30 January 1990	150	REPRINTED WITHOUT CHANGE
151	28 June 1995	151	30 January 1990
152-152d	28 June 1995	152	30 January 1990
267-275	28 June 1995	267-275	30 January 1990
276	30 January 1990	276	REPRINTED WITHOUT CHANGE
281	28 June 1995	281	30 January 1990
282	28 June 1995	282	30 January 1990
421	30 January 1990	421	REPRINTED WITHOUT CHANGE
422-422a	28 June 1995	422	30 January 1990
569	30 January 1990	569	REPRINTED WITHOUT CHANGE
570	28 June 1995	570	30 January 1990

3. RETAIN THIS NOTICE AND INSERT BEFORE TABLE OF CONTENTS.

4. Holders of MIL-STD-1797A will verify that corrections, page changes, and additions indicated above have been entered. This notice page will be retained as a check sheet. This issuance, together with appended pages, is a separate publication. Each notice is to be retained by stocking points until the military standard is completely revised or canceled.

Custodian:
 Army - AV
 Navy - AS
 Air Force - 11

Preparing Activity:
 Air Force - 11

 (Project 15GP-0111)

MIL-STD-1797A

FOREWORD

This standard is intended for use with fixed-wing aircraft supported primarily by aerodynamic force rather than engine thrust. It also covers the handling characteristics of aircraft under piloted control on the ground, and may be used with powered-lift aircraft in aerodynamic flight (above the conversion speed, V_{con}). This standard also applies to piloted transatmospheric flight when flight depends upon aerodynamic lift and/or air breathing propulsion systems. Flying qualities of military rotorcraft are specified in MIL-H-8501. while flying qualities in V/STOL flight are the subject of MIL-F-83300.

For further background information, see Appendix C.

MIL-STD-1797A

CONTENTS

Paragraph Number	Title	Standard Page
1.	SCOPE	1
1.1	Purpose.....	1
1.2	Applicability.....	1
2.	APPLICABLE DOCUMENTS	1
2.1	Government documents.....	1
2.1.1	Specifications, standards, and handbooks.....	1
2.1.2	Other Government documents, drawings, and publications.....	1
2.2	Non-Government publications.....	1
2.3	Order of precedence.....	1
3.	DEFINITIONS	2
3.1	Aircraft classification and operational missions.....	2
3.2	Flight Phase Categories.....	2
3.3	Levels and qualitative suitability of flying qualities.....	2
3.4	Parameters.....	2
3.4.1	General terms.....	2
3.4.2	Speeds.....	3
3.4.3	Thrust and power.....	5
3.4.4	Control parameters.....	6
3.4.5	Longitudinal parameters.....	6
3.4.6	Lateral-directional parameters.....	8
3.4.7	Atmospheric disturbance parameters.....	16
3.5	Terms used in high angle of attack requirements.....	18
4.	REQUIREMENTS	19
4.1	General requirements.....	19
4.1.1	Loadings.....	19
4.1.2	Moments and products of inertia.....	19
4.1.3	Internal and external stores.....	19
4.1.4	Flight Envelopes.....	19
4.1.4.1	Operational Flight Envelopes.....	19
4.1.4.2	Service Flight Envelopes.....	19
4.1.4.3	Permissible Flight Envelopes.....	19
4.1.5	Configurations and States of the aircraft.....	19
4.1.6	Aircraft Normal States.....	22
4.1.6.1	Allowable Levels for Aircraft Normal States.....	22
4.1.6.2	Flight outside the Service Flight Envelopes.....	22
4.1.6.3	Ground operation.....	22
4.1.7	Aircraft Failure States.....	22
4.1.7.1	Allowable Levels for Aircraft Failure States.....	22
4.1.7.2	Aircraft Special Failure States.....	22
4.1.7.3	Probability calculation.....	22
4.1.7.4	Generic failure analysis.....	25
4.1.7.5	When Levels are not specified.....	25
4.1.7.6	Failures outside the Service Flight Envelopes.....	25
4.1.8	Dangerous flight conditions.....	25
4.1.8.1	Warning and indication.....	25
4.1.8.2	Devices for indication, warning, prevention, and recovery.....	26
4.1.9	Interpretation of subjective requirements.....	26
4.1.10	Interpretation of quantitative requirements.....	26
4.1.11	General flying qualities requirements.....	26

MIL-STD-1797A

CONTENTS

Paragraph Number	Title	Standard Page
4.1.11.1	Buffet.....	26
4.1.11.2	Release of stores.....	26
4.1.11.3	Effects of armament delivery and special equipment.....	26
4.1.11.4	Failures.....	26
4.1.11.5	Control margin.....	27
4.1.11.6	Pilot-induced oscillations (PIO).....	27
4.1.11.7	Residual oscillations.....	27
4.1.11.8	Control cross-coupling.....	27
4.1.12	General flight control system characteristics.....	27
4.1.12.1	Control centering and breakout forces.....	27
4.1.12.2	Cockpit control free play.....	28
4.1.12.3	Adjustable controls.....	28
4.1.12.4	Rate of control displacement.....	28
4.1.12.5	Dynamic characteristics.....	28
4.1.12.6	Damping.....	28
4.1.12.7	Transfer to alternate control modes.....	28
4.1.12.8	Flight control system failures.....	28
4.1.12.9	Augmentation systems.....	28
4.1.12.10	Auxiliary dive recovery devices.....	29
4.1.12.11	Direct force controllers.....	29
4.1.13	General trim requirements.....	29
4.1.13.1	Trim system irreversibility.....	29
4.1.13.2	Rate of trim operation.....	29
4.1.13.3	Stalling of trim systems.....	29
4.1.13.4	Transients and trim changes.....	29
4.1.13.5	Trim for asymmetric thrust.....	30
4.1.13.6	Automatic trim system.....	30
4.2	Flying qualities requirements for the pitch axis.....	30
4.2.1	Pitch attitude dynamic response to pitch controller.....	30
4.2.1.1	Long-term pitch response.....	30
4.2.1.2	Short-term pitch response.....	30
4.2.2	Pilot-induced pitch oscillations.....	30
4.2.3	Residual pitch oscillations.....	30
4.2.4	Normal acceleration at pilot station.....	30
4.2.5	Pitch trim changes.....	30
4.2.6	Pitch axis response to other inputs.....	31
4.2.6.1	Pitch axis response to failures, controls free.....	31
4.2.6.2	Pitch axis response to configuration or control mode change.....	31
4.2.7	Pitch axis control power.....	33
4.2.7.1	Pitch axis control power in unaccelerated flight.....	33
4.2.7.2	Pitch axis control power in maneuvering flight.....	33
4.2.7.2.1	Load factor response.....	33
4.2.7.3	Pitch axis control power in takeoff.....	33
4.2.7.4	Pitch axis control power in landing.....	33
4.2.8	Pitch axis control forces.....	33
4.2.8.1	Pitch axis control forces--steady-state control force per g.....	33
4.2.8.2	Pitch axis control forces--transient control force per g.....	33
4.2.8.3	Pitch axis control forces--control force variations during rapid speed changes.....	34
4.2.8.4	Pitch axis control forces--control force vs. control deflection.....	34
4.2.8.5	Pitch axis control breakout forces.....	34
4.2.8.6	Pitch axis control force limits.....	34
4.2.8.6.1	Pitch axis control force limits--takeoff.....	34

MIL-STD-1797A

CONTENTS

Paragraph Number	Title	Standard Page
4.2.8.6.2	Pitch axis control force limits--landing.	34
4.2.8.6.3	Pitch axis control force limits--dives.	34
4.2.8.6.4	Pitch axis control force limits--sideslips.	34
4.2.8.6.5	Pitch axis control force limits--failures.	35
4.2.8.6.6	Pitch axis control force limits-control mode change.	35
4.2.8.7	Pitch axis trim systems.	35
4.2.9	Pitch axis control displacements.	35
4.2.9.1	Pitch axis control displacements-takeoff.	35
4.2.9.2	Pitch axis control displacements-maneuvering.	35
4.3	Flying qualities requirements for the normal (flight path) axis.	35
4.3.1	Flight path response to attitude change.	35
4.3.1.1	Transient flight path response to attitude change.	35
4.3.1.2	Steady-state flight path response to attitude change.	35
4.3.2	Flight path response to designated flight path controller.	36
4.3.3	Flight path control power.	36
4.3.3.1	Control power for designated primary flight path controller.	36
4.3.3.2	Control power for designated secondary flight path controller.	36
4.3.4	Flight path controller characteristics.	36
4.4	Flying qualities requirements for the longitudinal (speed) axis.	36
4.4.1	Speed response to attitude changes.	36
4.4.1.1	Speed response to attitude changes-relaxation in transonic flight.	36
4.5	Flying qualities requirements for the roll axis.	36
4.5.1	Roll response to roll controller.	36
4.5.1.1	Roll mode.	36
4.5.1.2	Spiral stability.	36
4.5.1.3	Coupled roll-spiral oscillation.	36
4.5.1.4	Roll oscillations.	37
4.5.1.5	Roll time delay.	37
4.5.2	Pilot-induced roll oscillations.	37
4.5.3	Linearity of roll response to roll controller.	37
4.5.4	Lateral acceleration at the pilot station.	37
4.5.5	Roll characteristics in steady sideslip.	37
4.5.6	Roll axis control for takeoff and landing in crosswinds.	37
4.5.7	Roll axis response to other inputs.	37
4.5.7.1	Roll axis response to augmentation failures.	37
4.5.7.2	Roll axis response to configuration or control mode change.	37
4.5.8	Roll axis control power.	38
4.5.8.1	Roll axis response to roll control inputs.	38
4.5.8.2	Roll axis control power in steady sideslips.	38
4.5.8.3	Roll axis control power in crosswinds.	38
4.5.8.4	Roll axis control power for asymmetric thrust.	38
4.5.8.5	Roll axis control power in dives and pullouts.	38
4.5.8.6	Roll axis control power for asymmetric loading.	38
4.5.9	Roll axis control forces and displacements.	39
4.5.9.1	Roll control displacements.	39
4.5.9.2	Roll axis control forces to achieve required roll performance.	39
4.5.9.3	Roll axis control sensitivity.	39
4.5.9.4	Roll axis control centering and breakout forces.	39
4.5.9.5	Roll axis control force limits.	39
4.5.9.5.1	Roll axis control force limits in steady turns.	39
4.5.9.5.2	Roll axis control force limits in dives and pullouts.	39
4.5.9.5.3	Roll axis control force limits in crosswinds.	39

MIL-STD-1797A

CONTENTS

Paragraph Number	Title	Standard Page
4.5.9.5.4	Roll axis control force limits in steady sideslips.....	39
4.5.9.5.5	Roll axis control force limits for asymmetric thrust.....	39
4.5.9.5.6	Roll axis control force limits for failures.....	39
4.5.9.5.7	Roll axis control force limits for configuration or control mode change.....	40
4.6	Flying qualities requirements for the yaw axis.....	40
4.6.1	Yaw axis response to yaw and side-force controllers.....	40
4.6.1.1	Dynamic lateral-directional response.....	40
4.6.1.2	Steady sideslips.....	40
4.6.1.3	Wings-level turn.....	40
4.6.2	Yaw axis response to roll controller.....	41
4.6.3	Pilot-induced yaw oscillations.....	41
4.6.4	Yaw axis control for takeoff and landing in crosswinds.....	41
4.6.5	Yaw axis response to other inputs.....	41
4.6.5.1	Yaw axis response to asymmetric thrust.....	41
4.6.5.2	Yaw axis response to failures.....	42
4.6.5.3	Yaw axis response to configuration or control mode change.....	42
4.6.6	Yaw axis control power.....	42
4.6.6.1	Yaw axis control power for takeoff, landing, and taxi.....	42
4.6.6.2	Yaw axis control power for asymmetric thrust.....	43
4.6.6.3	Yaw axis control power with asymmetric loading.....	43
4.6.7	Yaw axis control forces.....	43
4.6.7.1	Yaw axis control force limits in rolling maneuvers.....	43
4.6.7.2	Yaw axis control force limits in steady turns.....	43
4.6.7.3	Yaw axis control force limits during speed changes.....	43
4.6.7.4	Yaw axis control force limits in crosswinds.....	43
4.6.7.5	Yaw axis control force limits with asymmetric loading.....	44
4.6.7.6	Yaw axis control force limits in dives and pullouts.....	44
4.6.7.7	Yaw axis control force limits for waveoff (go-around).....	44
4.6.7.8	Yaw axis control force limits for asymmetric thrust during takeoff.....	44
4.6.7.9	Yaw axis control force limits with flight control failures.....	44
4.6.7.10	Yaw axis control force limits-control mode change.....	44
4.6.7.11	Yaw axis breakout forces.....	44
4.7	Flying qualities requirements for the lateral flight path axis.....	44
4.7.1	Dynamic response for lateral translation.....	44
4.8	Flying qualities requirements for combined axes.....	45
4.8.1	Cross-axis coupling in roll maneuvers.....	45
4.8.2	Crosstalk between pitch and roll controllers.....	45
4.8.3	Control harmony.....	45
4.8.4	Flight at high angle of attack.....	45
4.8.4.1	Warning cues.....	45
4.8.4.2	Stalls.....	45
4.8.4.2.1	Stall approach.....	45
4.8.4.2.2	Stall characteristics.....	45
4.8.4.2.3	Stall prevention and recovery.....	46
4.8.4.2.4	One-engine-out stalls.....	46
4.8.4.3	Post-stall gyrations and spins.....	46
4.8.4.3.1	Departure from controlled flight.....	46
4.8.4.3.2	Recovery from post-stall gyrations and spins.....	46
4.9	Flying qualities requirements in atmospheric disturbances.....	47
4.9.1	Allowable flying qualities degradations in atmospheric disturbances.....	47
4.9.2	Definition of atmospheric disturbance model form.....	48
4.9.3	Application of disturbance models in analyses.....	48

MIL-STD-1797A

CONTENTS

Paragraph Number	Title	Standard Page
5.	VERIFICATION	49
5.1	General requirements-verification	49
5.1.1	Loadings-verification.....	49
5.1.2	Moments and products of inertia-verification.....	49
5.1.3	Internal and external stores-verification.	49
5.1.4	Flight Envelopes-verification.....	49
5.1.4.1	Operational Flight Envelopes-verification.....	49
5.1.4.2	Service Flight Envelopes-verification.	49
5.1.4.3	Permissible Flight Envelopes-verification.....	49
5.1.5	Configurations and States of the aircraft-verification.	49
5.1.6	Aircraft Normal States-verification.	49
5.1.6.1	Allowable Levels for Aircraft Normal States-verification.....	49
5.1.6.2	Flight outside the Service Flight Envelopes-verification.....	49
5.1.6.3	Ground operation-verification.	49
5.1.7	Aircraft Failure States-verification.	49
5.1.7.1	Allowable Levels for Aircraft Failure States-verification	50
5.1.7.2	Aircraft Special Failure States-verification.....	50
5.1.7.3	Probability calculation-verification.	50
5.1.7.4	Generic failure analysis-verification.....	50
5.1.7.5	When Levels are not specified-verification.....	50
5.1.7.6	Failures outside the Service Flight Envelopes-verification.....	50
5.1.8	Dangerous flight conditions-verification.....	50
5.1.8.1	Warning and indication-verification.	50
5.1.8.2	Devices for indication, warning, prevention, and recovery-verification.	50
5.1.9	Interpretation of subjective requirements-verification.....	50
5.1.10	Interpretation of quantitative requirements-verification.	50
5.1.11	General flying qualities requirements-verification.....	50
5.1.11.1	Buffet-verification.....	50
5.1.11.2	Release of stores-verification.	50
5.1.11.3	Effects or armament delivery and special equipment-verification.....	50
5.1.11.4	Failures-verification.	50
5.1.11.5	Control margin-verification.....	50
5.1.11.6	Pilot-induced oscillations(PIO)-verification.	51
5.1.11.7	Residual oscillations-verification.	51
5.1.11.8	Control cross-coupling-verification.	51
5.1.12	General flight control system characteristics-verification.	51
5.1.12.1	Control centering and breakout forces-verification.....	51
5.1.12.2	Cockpit control free play-verification.	51
5.1.12.3	Adjustable controls-verification.....	51
5.1.12.4	Rate of control displacement-verification.	51
5.1.12.5	Dynamic characteristics-verification.	51
5.1.12.6	Damping-verification.....	51
5.1.12.7	Transfer to alternate control modes-verification.....	51
5.1.12.8	Flight control system failures-verification.	51
5.1.12.9	Augmentation systems-verification.....	51
5.1.12.10	Auxiliary dive recovery devices-verification.....	51
5.1.12.11	Direct force controllers-verification.	51
5.1.13	General trim requirements-verification	51
5.1.13.1	Trim system irreversibility-verification.	51
5.1.13.2	Rate of trim operation-verification.	52
5.1.13.3	Stalling of trim systems-verification.....	52

MIL-STD-1797A

CONTENTS

Paragraph Number	Title	Standard Page
5.1.13.4	Transients and trim changes-verification.....	52
5.1.13.5	Trim for asymmetric thrust-verification.....	52
5.1.13.6	Automatic trim system-verification.....	52
5.2	Flying qualities requirements for the pitch axis-verification.....	52
5.2.1	Pitch attitude dynamic response to pitch controller-verification.....	52
5.2.1.1	Long-term pitch response-verification.....	52
5.2.1.2	Short-term pitch response-verification.....	52
5.2.2	Pilot-induced pitch oscillations-verification.....	52
5.2.3	Residual pitch oscillations-verification.....	52
5.2.4	Normal acceleration at pilot station-verification.....	52
5.2.5	Pitch trim changes-verification.....	52
5.2.6	Pitch axis response to other inputs-verification.....	52
5.2.6.1	Pitch axis response to failures, controls free-verification.....	52
5.2.6.2	Pitch axis response to configuration or control mode change-verification.....	52
5.2.7	Pitch axis control power-verification.....	52
5.2.7.1	Pitch axis control power in unaccelerated flight-verification.....	52
5.2.7.2	Pitch axis control power in maneuvering flight-verification.....	52
5.2.7.2.1	Load factor response-verification.....	53
5.2.7.3	Pitch axis control power in takeoff-verification.....	53
5.2.7.4	Pitch axis control power in landing-verification.....	53
5.2.8	Pitch axis control forces-verification.....	53
5.2.8.1	Pitch axis control forces-steady-state control force per g-verification.....	53
5.2.8.2	Pitch axis control forces-transient control force per g-verification.....	53
5.2.8.3	Pitch axis control forces-control force variations during rapid speed changes -verification.....	53
5.2.8.4	Pitch axis control forces-control force vs. control deflection-verification.....	53
5.2.8.5	Pitch axis control breakout forces-verification.....	53
5.2.8.6	Pitch axis control force limits-verification.....	53
5.2.8.6.1	Pitch axis control force limits-takeoff-verification.....	53
5.2.8.7	Pitch axis control force limits-landing-verification.....	53
5.2.8.7.1	Pitch axis control force limits-dives-verification.....	53
5.2.8.7.2	Pitch axis control force limits-sideslips-verification.....	53
5.2.8.7.3	Pitch axis control force limits-failures-verification.....	53
5.2.8.7.4	Pitch axis control force limits-control mode change-verification.....	53
5.2.8.8	Pitch axis trim systems-verification.....	53
5.2.9	Pitch axis control displacements-verification.....	54
5.2.9.1	Pitch axis control displacements-takeoff-verification.....	54
5.2.9.2	Pitch axis control displacements-maneuvering-verification.....	54
5.3	Flying qualities requirements for the normal (flight path) axis-verification.....	54
5.3.1	Flight path response to attitude change-verification.....	54
5.3.1.1	Transient flight path response to attitude change-verification.....	54
5.3.1.2	Steady-state flight path response to attitude change-verification.....	54
5.3.2	Flight path response to designated flight path controller-verification.....	54
5.3.3	Flight path control power-verification.....	54
5.3.3.1	Control power for designated primary flight path controller-verification.....	54
5.3.3.2	Control power for designated secondary flight path controller-verification.....	54
5.3.4	Flight path controller characteristics-verification.....	54
5.4	Flying qualities requirements for the longitudinal (speed) axis-verification.....	54
5.4.1	Speed response to attitude changes-verification.....	54
5.4.1.1	Speed response to attitude changes-relaxation in transonic flight-verification.....	54
5.5	Flying qualities requirements for the roll axis-verification.....	54
5.5.1	Roll response to roll controller-verification.....	54

MIL-STD-1797A

CONTENTS

Paragraph Number	Title	Standard Page
5.5.1.1	Roll mode-verification.	54
5.5.1.2	Spiral stability-verification.	54
5.5.1.3	Coupled roll-spiral oscillation-verification.	55
5.5.1.4	Roll oscillations-verification.	55
5.5.1.5	Roll time delay-verification.	55
5.5.2	Pilot-induced roll oscillations-verification.	55
5.5.3	Linearity of roll response to roll controller-verification.	55
5.5.4	Lateral acceleration at the pilot station-verification.	55
5.5.5	Roll characteristics in steady sideslip-verification.	55
5.5.6	Roll axis control for takeoff and landing in crosswinds-verification.	55
5.5.7	Roll axis response to other inputs-verification.	55
5.5.7.1	Roll axis response to augmentation failures-verification.	55
5.5.7.2	Roll axis response to configuration or control mode change-verification.	55
5.5.8	Roll axis control power-verification.	55
5.5.8.1	Roll axis response to roll control inputs-verification.	55
5.5.8.2	Roll axis control power in steady sideslips-verification.	55
5.5.8.3	Roll axis control power in crosswinds-verification.	55
5.5.8.4	Roll axis control power for asymmetric thrust-verification.	55
5.5.8.5	Roll axis control power in dives and pullouts-verification.	55
5.5.8.6	Roll axis control power for asymmetric loading-verification.	55
5.5.9	Roll axis control forces and displacements-verification.	56
5.5.9.1	Roll control displacements-verification.	56
5.5.9.2	Roll axis control forces to achieve required roll performance-verification.	56
5.5.9.3	Roll axis control sensitivity-verification.	56
5.5.9.4	Roll axis control centering and breakout forces-verification.	56
5.5.9.5	Roll axis control force limits-verification.	56
5.5.9.5.1	Roll axis control force limits in steady turns-verification.	56
5.5.9.5.2	Roll axis control force limits in dives and pullouts-verification.	56
5.5.9.5.3	Roll axis control force limits in crosswinds-verification.	56
5.5.9.5.4	Roll axis control force limits in steady sideslips-verification.	56
5.5.9.5.5	Roll axis control force limits for asymmetric thrust-verification.	56
5.5.9.5.6	Roll axis control force limits for failures-verification.	56
5.5.9.5.7	Roll axis control force limits for configuration or control mode change-verification.	56
5.6	Flying qualities requirements for the yaw axis-verification.	56
5.6.1	Yaw axis response to yaw and side-force controllers-verification.	56
5.6.1.1	Dynamic lateral-directional response-verification.	56
5.6.1.2	Steady sideslips-verification.	56
5.6.1.3	Wings-level turn-verification.	56
5.6.2	Yaw axis response to roll controller-verification.	56
5.6.3	Pilot-induced yaw oscillations-verification.	57
5.6.4	Yaw axis control for takeoff and landing in crosswinds-verification.	57
5.6.5	Yaw axis response to other inputs-verification.	57
5.6.5.1	Yaw axis response to asymmetric thrust-verification.	57
5.6.5.2	Yaw axis response to failures-verification.	57
5.6.5.3	Yaw axis response to configuration or control mode change-verification.	57
5.6.6	Yaw axis control power-verification.	57
5.6.6.1	Yaw axis control power for takeoff, landing, and taxi-verification.	57
5.6.6.2	Yaw axis control power for asymmetric thrust-verification.	57
5.6.6.3	Yaw axis control power with asymmetric loading-verification.	57
5.6.7	Yaw axis control forces-verification.	57
5.6.7.1	Yaw axis control force limits in rolling maneuvers-verification.	57
5.6.7.2	Yaw axis control force limits in steady turns-verification.	57

MIL-STD-1797A

CONTENTS

Paragraph Number	Title	Standard Page
5.6.7.3	Yaw axis control force limits during speed changes-verification.....	57
5.6.7.4	Yaw axis control force limits in crosswinds-verification.....	57
5.6.7.5	Yaw axis control force limits with asymmetric loading-verification.....	57
5.6.7.6	Yaw axis control force limits in dives and pullouts-verification.....	57
5.6.7.7	Yaw axis control force limits for waveoff (go-around)-verification.....	57
5.6.7.8	Yaw axis control force limits for asymmetric thrust during takeoff-verification.....	58
5.6.7.9	Yaw axis control force limits with flight control failures-verification.....	58
5.6.7.10	Yaw axis control force limits-control mode change-verification.....	58
5.6.7.11	Yaw axis breakout forces-verification.....	58
5.7	Flying qualities requirements for the lateral flight path axis-verification.....	58
5.7.1	Dynamic response for lateral translation-verification.....	58
5.8	Flying qualities requirements for combined axes-verification.....	58
5.8.1	Cross-axis coupling in roll maneuvers-verification.....	58
5.8.2	Crosstalk between pitch and roll controllers-verification.....	58
5.8.3	Control harmony-verification.....	58
5.8.4	Flight at high angle of attack-verification.....	58
5.8.4.1	Warning cues-verification.....	58
5.8.4.2	Stalls-verification.....	58
5.8.4.2.1	Stall approach-verification.....	58
5.8.4.2.2	Stall characteristics-verification.....	58
5.8.4.2.3	Stall prevention and recovery-verification.....	58
5.8.4.2.4	One-engine-out stalls-verification.....	58
5.8.4.3	Post-stall gyrations and spins-verification.....	58
5.8.4.3.1	Departure from controlled flight-verification.....	58
5.8.4.3.2	Recovery from post-stall gyrations and spins-verification.....	59
5.9	Flying qualities requirements in atmospheric disturbances-verification.....	59
5.9.1	Allowable flying qualities degradations in atmospheric disturbances-verification.....	59
5.9.2	Definition of atmospheric disturbance model form-verification.....	59
5.9.3	Application of disturbance models in analyses-verification.....	59
6.	NOTES	59
6.1	Intended use.....	59
6.2	Level definitions.....	59
6.3	Reference documents tree.....	59
6.4	Data requirements.....	60
6.5	Subject term (key word) listing.....	61
6.6	Responsible engineering office (REO).....	61
6.7	Changes from previous issue.....	61

APPENDIX A CONTENTS

Paragraph Number	Title	Page
10.	SCOPE	69
10.1	Scope.....	69
10.2	Purpose.....	69
10.3	Use.....	69
10.4	Format	69
10.4.1	Requirement/verification identity.....	69
10.4.2	Requirement/verification package.....	69
10.5	Responsible engineering office.....	69
20.	APPLICABLE DOCUMENTS	69
20.1	References.....	69
20.2	Avoidance of tiering.....	69
20.3	Government documents.....	69
30.	DEFINITIONS	88
3.1	Aircraft classification and operational missions.....	88
3.2	Flight Phase Categories.....	92
3.3	Levels and qualitative suitability of flying qualities.....	97
40.	REQUIREMENTS.....	101
4.1	General requirements.....	101
4.1.1	Loadings.....	101
4.1.2	Moments and products of inertia.....	103
4.1.3	Internal and external stores.....	105
4.1.4	Flight Envelopes.....	106
4.1.4.2	Service Flight Envelopes.....	112
4.1.4.3	Permissible Flight Envelopes.....	115
4.1.5	Configurations and States of the aircraft.....	117
4.1.6	Aircraft Normal States.....	119
4.1.6.1	Allowable Levels for Aircraft Normal States.....	120
4.1.6.2	Flight outside the Service Flight Envelopes.....	120
4.1.6.3	Ground operation.....	120
4.1.7	Aircraft Failure States.....	122
4.1.7.1	Allowable Levels for Aircraft Failure States.....	123
4.1.7.2	Aircraft Special Failure States.....	124
4.1.7.3	Probability calculation.....	126
4.1.7.4	Generic failure analysis.....	135
4.1.7.5	When Levels are not specified.....	138
4.1.7.6	Failures outside the Service Flight Envelopes.....	139
4.1.8	Dangerous flight conditions.....	140
4.1.8.1	Warning and indication.....	140
4.1.8.2	Devices for indication, warning, prevention, and recovery.....	140
4.1.9	Interpretation of subjective requirements.....	142
4.1.10	Interpretation of quantitative requirements.....	143
4.1.11	General flying qualities requirements.....	146
4.1.11.1	Buffet.....	146
4.1.11.2	Release of stores.....	149
4.1.11.3	Effects of armament delivery and special equipment.....	150
4.1.11.4	Failures.....	151
4.1.11.5	Control margin.....	155
4.1.11.6	Pilot-induced oscillations (PIO).....	163
4.1.11.7	Residual oscillations.....	165

MIL-STD-1797A

APPENDIX A CONTENTS

Paragraph Number	Title	Page
4.1.11.8	Control cross-coupling.....	166
4.1.12	General flight control system characteristics.....	168
4.1.12.1	Control centering and breakout forces.....	168
4.1.12.2	Cockpit control free play.....	168
4.1.12.3	Adjustable controls.....	168
4.1.12.4	Rate of control displacement.....	171
4.1.12.5	Dynamic characteristics.....	171
4.1.12.6	Damping.....	171
4.1.12.7	Transfer to alternate control modes.....	171
4.1.12.8	Flight control system failures.....	171
4.1.12.9	Augmentation systems.....	171
4.1.12.10	Auxiliary dive recovery devices.....	171
4.1.12.11	Direct force controllers.....	171
4.1.13	General trim requirements.....	176
4.1.13.1	Trim system irreversibility.....	176
4.1.13.2	Rate of trim operation.....	176
4.1.13.3	Stalling of trim systems.....	176
4.1.13.4	Transients and trim changes.....	176
4.1.13.5	Trim for asymmetric thrust.....	176
4.1.13.6	Automatic trim system.....	176
4.2	Flying qualities requirements for the pitch axis.....	179
4.2.1	Pitch attitude dynamic response to pitch controller.....	179
4.2.1.1	Long-term pitch response.....	179
4.2.1.2	Short-term pitch response.....	183
4.2.2	Pilot-induced pitch oscillations.....	281
4.2.3	Residual pitch oscillations.....	290
4.2.4	Normal acceleration at pilot station.....	292
4.2.5	Pitch trim changes.....	295
4.2.6	Pitch axis response to other inputs.....	297
4.2.6.1	Pitch axis response to failures. controls free.....	297
4.2.6.2	Pitch axis response to configuration or control mode change.....	299
4.2.7	Pitch axis control power.....	301
4.2.7.1	Pitch axis control power in unaccelerated flight.....	301
4.2.7.2	Pitch axis control power in maneuvering flight.....	302
4.2.7.2.1	Load factor response.....	304
4.2.7.3	Pitch axis control power in takeoff.....	306
4.2.7.4	Pitch axis control power in landing.....	309
4.2.8	Pitch axis control forces.....	311
4.2.8.1	Pitch axis control forces--steady-state control force per g.....	316
4.2.8.2	Pitch axis control forces--transient control force per g.....	332
4.2.8.3	Pitch axis control forces--control force variations during rapid speed changes.....	340
4.2.8.4	Pitch axis control forces--control force vs. control deflection.....	341
4.2.8.5	Pitch axis control breakout forces.....	350
4.2.8.6	Pitch axis control force limits.....	351
4.2.8.6.1	Pitch axis control force limits -- takeoff.....	351
4.2.8.6.2	Pitch axis control force limits--landing.....	353
4.2.8.6.3	Pitch axis control force limits--dives.....	355
4.2.8.6.4	Pitch axis control force limits--sideslips.....	357
4.2.8.6.5	Pitch axis control force limits--failures.....	359
4.2.8.6.6	Pitch axis control force limits--control mode change.....	360
4.2.8.7	Pitch axis trim systems.....	361
4.2.9	Pitch axis control displacements.....	363

MIL-STD-1797A

APPENDIX A CONTENTS

Paragraph Number	Title	Page
4.2.9.1	Pitch axis control displacements -- takeoff.....	363
4.2.9.2	Pitch axis control displacements--maneuvering.....	365
4.3	Flying quality requirements for normal (flight path) axis.....	366
4.3.1	Flight path response to attitude change.....	367
4.3.1.1	Transient flight path response to attitude change.....	367
4.3.1.2	Steady-state flight path response to attitude change.....	371
4.3.2	Flight path response to designated flight path controller.....	381
4.3.3	Flight path control power.....	382
4.3.3.1	Control power for designated primary flight path controller.....	382
4.3.3.2	Control power for designated secondary flight path controller.....	382
4.3.4	Flight path controller characteristics.....	382
4.4	Flying qualities requirements for longitudinal (speed) axis.....	384
4.4.1	Speed response to attitude changes.....	384
4.4.1.1	Speed response to attitude changes--relaxation in transonic flight.....	389
4.5	Flying qualities requirements for the roll axis.....	391
4.5.1	Roll response to roll controller.....	391
4.5.1.1	Roll mode.....	391
4.5.1.2	Spiral stability.....	406
4.5.1.3	Coupled roll-spiral oscillation.....	410
4.5.1.4	Roll oscillations.....	418
4.5.1.5	Roll time delay.....	433
4.5.2	Pilot-induced roll oscillations.....	436
4.5.3	Linearity of roll response o roll controller.....	437
4.5.4	Lateral acceleration at pilot station.....	438
4.5.5	Roll characteristics in steady sideslip.....	442
4.5.6	Roll axis control for takeoff and landing in crosswinds.....	444
4.5.7	Roll axis response to other inputs.....	445
4.5.7.1	Roll axis response to augmentation failures.....	445
4.5.7.2	Roll axis response to configuration or control mode change.....	447
4.5.8	Roll axis control power.....	448
4.5.8.1	Roll axis response to roll control inputs.....	448
4.5.8.2	Roll axis control power in steady sideslips.....	476
4.5.8.3	Roll axis control power in crosswinds.....	477
4.5.8.4	Roll axis control power for asymmetric thrust.....	480
4.5.8.5	Roll axis control power in dives and pullouts.....	482
4.5.8.6	Roll axis control power for asymmetric loading.....	483
4.5.9	Roll axis control forces and displacements.....	484
4.5.9.1	Roll control displacements.....	488
4.5.9.2	Roll axis control forces to achieve required roll performance.....	490
4.5.9.3	Roll axis control sensitivity.....	492
4.5.9.4	Roll axis control centering and breakout forces.....	510
4.5.9.5	Roll axis control force limits.....	511
4.5.9.5.1	Roll axis control force limits in steady turns.....	511
4.5.9.5.2	Roll axis control force limits in dives and pullouts.....	513
4.5.9.5.3	Roll axis control force limits in crosswinds.....	514
4.5.9.5.4	Roll axis control force limits in steady sideslips.....	515
4.5.9.5.5	Roll axis control force limits for asymmetric thrust.....	516
4.5.9.5.6	Roll axis control force limits for failures.....	517
4.5.9.5.7	Roll axis control force limits for configuration or control mode change.....	518
4.6	Flying quality requirements for the yaw axis.....	519
4.6.1	Yaw axis response to yaw and side-force controllers.....	519
4.6.1.1	Dynamic lateral-directional response.....	519

MIL-STD-1797A

APPENDIX A CONTENTS

Paragraph Number	Title	Page
4.6.1.2	Steady sideslips.....	542
4.6.1.3	Wings-level turn.....	545
4.6.2	Yaw axis response to roll controller.....	554
4.6.3	Pilot-induced yaw oscillations.....	584
4.6.4	Yaw axis control for takeoff and landing in crosswinds.....	585
4.6.5	Yaw axis response to other inputs.....	588
4.6.5.1	Yaw axis response to asymmetric thrust.....	588
4.6.5.2	Yaw axis response to failures.....	593
4.6.5.3	Yaw axis response to configuration or control mode change.....	594
4.6.6	Yaw axis control power.....	595
4.6.6.1	Yaw axis control power for takeoff, landing, and taxi.....	596
4.6.6.2	Yaw axis control power for asymmetric thrust.....	598
4.6.6.3	Yaw axis control power with asymmetric loading.....	599
4.6.7	Yaw axis control forces.....	600
4.6.7.1	Yaw axis control force limits in rolling maneuvers.....	601
4.6.7.2	Yaw axis control force limits in steady turns.....	602
4.6.7.3	Yaw axis control force limits during speed changes.....	604
4.6.7.4	Yaw axis control force limits in crosswinds.....	605
4.6.7.5	Yaw axis control force limits with asymmetric loading.....	606
4.6.7.6	Yaw axis control force limits in dives and pullouts.....	607
4.6.7.7	Yaw axis control force limits for waveoff (go-around).....	608
4.6.7.8	Yaw axis control force limits for asymmetric thrust during, takeoff.....	609
4.6.7.9	Yaw axis control force limits with flight control failures.....	610
4.6.7.10	Yaw axis control force limits -- control mode change.....	611
4.6.7.11	Yaw axis breakout forces.....	612
4.7	Flying qualities requirements for the lateral flight path axis.....	613
4.7.1	Dynamic response for lateral translation.....	613
4.8	Flying qualities requirements for combined axes.....	616
4.8.1	Cross-axis coupling in roll maneuvers.....	616
4.8.2	Crosstalk between pitch and roll controllers.....	620
4.8.3	Control harmony.....	622
4.8.4	Flight at high angle of attack.....	624
4.8.4.1	Warning cues.....	630
4.8.4.2	Stalls.....	632
4.8.4.2.1	Stall approach.....	634
4.8.4.2.2	Stall characteristics.....	637
4.8.4.2.3	Stall prevention and recovery.....	639
4.8.4.2.4	One-engine-out stalls.....	643
4.8.4.3	Post-stall gyrations and spins.....	645
4.8.4.3.1	Departure from controlled flight.....	649
4.8.4.3.2	Recovery from post-stall gyrations and spins.....	657
4.9	Flying qualities requirements in atmospheric disturbances.....	663
4.9.1	Allowable flying qualities degradations in atmospheric disturbances.....	663
4.9.2	Definition of atmospheric disturbance model form.....	671
4.9.3	Application of disturbance models in analyses.....	684
5.1	General requirements-verification.....	102
5.1.1	Loadings-verification.....	102
5.1.2	Moments and products of inertia-verification.....	103
5.1.3	Internal and external stores-verification.....	105
5.1.4	Flight Envelopes-verification.....	111
5.1.4.1	Operational Flight Envelopes-verification.....	111

MIL-STD-1797A

APPENDIX A CONTENTS

Paragraph Number	Title	Page
5.1.4.2	Service Flight Envelopes-verification.	114
5.1.4.3	Permissible Flight Envelopes-verification.	116
5.1.5	Configurations and States of the aircraft-verification.	118
5.1.6	Aircraft Normal States-verification.	119
5.1.6.1	Allowable Levels for Aircraft Normal States-verification.	121
5.1.6.2	Flight outside the Service Flight Envelopes-verification.	121
5.1.6.3	Ground operation-verification.	121
5.1.7	Aircraft Failure States-verification.	122
5.1.7.1	Allowable Levels for Aircraft Failure States-verification.	125
5.1.7.2	Aircraft Special Failure States-verification.	125
5.1.7.3	Probability calculation-verification.	131
5.1.7.4	Generic failure analysis-verification.	137
5.1.7.5	When Levels are not specified-verification.	138
5.1.7.6	Failures outside the Service Flight Envelope-verification.	139
5.1.8	Dangerous flight conditions-verification.	141
5.1.8.1	Warning and indication-verification.	141
5.1.8.2	Devices for indication, warning, prevention, and recovery-verification.	141
5.1.9	Interpretation of subjective requirements-verification.	142
5.1.10	Interpretation of quantitative requirements-verification.	145
5.1.11	General flying qualities-verification.	147
5.1.11.1	Buffet-verification.	147
5.1.11.2	Release of stores-verification.	149
5.1.11.3	Effects of armament delivery and special equipment-verification.	150
5.1.11.4	Failures-verification.	154
5.1.11.5	Control margin-verification.	158
5.1.11.6	Pilot-induced oscillations (PIO)-verification.	163
5.1.11.7	Residual oscillations-verification.	165
5.1.11.8	Control cross-coupling-verification.	166
5.1.12	General flight control system characteristics-verification.	169
5.1.12.1	Control centering and breakout forces-verification.	169
5.1.12.2	Cockpit control free play-verification.	169
5.1.12.3	Adjustable controls-verification.	170
5.1.12.4	Rate of control displacement-verification.	174
5.1.12.5	Dynamic characteristics-verification.	174
5.1.12.6	Damping-verification.	174
5.1.12.7	Transfer to alternate control modes-verification.	174
5.1.12.8	Flight control system failures-verification.	174
5.1.12.9	Augmentation systems-verification.	174
5.1.12.10	Auxiliary dive recovery devices-verification.	174
5.1.12.11	Direct force controllers-verification.	174
5.1.13	General trim requirements-verification.	178
5.1.13.1	Trim system irreversibility-verification.	178
5.1.13.2	Rate of trim operation-verification.	178
5.1.13.3	Stalling of trim systems-verification.	178
5.1.3.4	Transients and trim changes-verification.	178
5.1.13.5	Trim for asymmetric thrust-verification.	178
5.1.13.6	Automatic trim system-verification.	178
5.2	Flying qualities requirements for the pitch axis-verification.	181
5.2.1	Pitch attitude dynamic response to pitch controller-verification.	181
5.2.1.1	Long-term pitch response-verification.	181
5.2.1.2	Short-term pitch response-verification.	272
5.2.2	Pilot-induced pitch oscillations-verification.	288

MIL-STD-1797A

APPENDIX A CONTENTS

Paragraph Number	Title	Page
5.2.3	Residual pitch oscillations-verification.....	290
5.2.4	Normal acceleration at pilot station-verification.....	293
5.2.5	Pitch trim changes-verification.....	295
5.2.6.1	Pitch axis response to failures, control free-verification.....	297
5.2.6.2	Pitch axis response to configuration or control mode change -verification.....	299
5.2.7.1	Pitch axis control power in unaccelerated flight-verification.....	301
5.2.7.2	Pitch axis control power in maneuvering flight-verification.....	303
5.2.7.2.1	Load factor response--verification.....	305
5.2.7.3	Pitch axis control power in takeoff-verification.....	308
5.2.7.4	Pitch axis control power in landing-verification.....	310
5.2.8.1	Pitch axis control forces--steady-state control force per g-verification.....	329
5.2.8.2	Pitch axis control forces-transient control force per g-verification.....	339
5.2.8.3	Pitch axis control forces--control force variations during rapid speed changes -verification.....	340
5.2.8.4	Pitch axis control forces--control force vs. control deflection-verification.....	348
5.2.8.5	Pitch axis control breakout forces-verification.....	350
5.2.8.6.1	Pitch axis control force limits-takeoff-verification.....	352
5.2.8.6.2	Pitch axis control force limits--landing -verification.....	353
5.2.8.6.3	Pitch axis control force limits--dives-verification.....	355
5.2.8.6.4	Pitch axis control force limits--sideslips-verification.....	357
5.2.8.6.5	Pitch axis control force limits--failures-verification.....	359
5.2.8.6.6	Pitch axis control force limits--control mode change -verification.....	360
5.2.8.7	Pitch axis trim systems-verification.....	362
5.2.9	Pitch axis control displacements-verification.....	363
5.2.9.1	Pitch axis control displacements--takeoff-verification.....	363
5.2.9.2	Pitch axis control displacements--maneuvering-verification.....	365
5.3	Flying qualities requirements for the normal (flight path) axis-verification.....	369
5.3.1	Flight path response to attitude change-verification.....	369
5.3.1.1	Transient flight path response to attitude change-verification.....	369
5.3.1.2	Steady-state flight path response to attitude change-verification.....	380
5.3.2	Flight path response to designated flight path controller-verification.....	381
5.3.3	Flight path control power.....	382
5.3.3.1	Control power for designated primary flight path controller-verification.....	382
5.3.3.2	Control power for designated secondary flight path controller-verification.....	382
5.3.4	Flight path controller characteristics-verification.....	382
5.4	Flying qualities requirements for longitudinal (speed) axis-verification.....	386
5.4.1	Speed response to attitude changes-verification.....	386
5.4.1.1	Speed response to attitude changes--relaxation in transonic flight-verification.....	389
5.5	Flying quality requirements for roll axis-verification.....	404
5.5.1	Roll response to roll controller-verification.....	404
5.5.1.1	Roll mode-verification.....	404
5.5.1.2	Spiral stability-verification.....	409
5.5.1.3	Coupled roll-spiral oscillation-verification.....	416
5.5.1.4	Roll oscillations-verification.....	431
5.5.1.5	Time delay-verification.....	435
5.5.2	Pilot-induced roll oscillations-verification.....	436
5.5.3	Linearity of roll response to roll controller-verification.....	437
5.5.4	Lateral acceleration at the pilot station-verification.....	440
5.5.5	Roll characteristics in steady sideslip-verification.....	443
5.5.6	Roll axis control for takeoff and landing in crosswinds-verification.....	444
5.5.7	Roll axis response to other inputs-verification.....	445
5.5.7.1	Roll axis response to augmentation failures-verification.....	445

MIL-STD-1797A

APPENDIX A CONTENTS

Paragraph Number	Title	Page
5.5.7.2	Roll axis response to configuration or control mode change-verification.....	447
5.5.8	Roll axis control power-verification.....	474
5.5.8.1	Roll axis response to roll control inputs-verification.....	474
5.5.8.2	Roll axis control power in steady sideslips--verification.....	476
5.5.8.3	Roll axis control power in crosswinds-verification.....	478
5.5.8.4	Roll axis control power for asymmetric thrust -verification.....	480
5.5.8.5	Roll axis control power in dives and pullouts-verification.....	482
5.5.8.6	Roll axis control power for asymmetric loading-verification.....	483
5.5.9.1	Wheel control displacements -verification.....	488
5.5.9.2	Roll axis control forces o achieve required roll performance-verification.....	491
5.5.9.3	Roll axis control sensitivity-verification.....	507
5.5.9.4	Roll axis control centering and breakout forces-verification.....	510
5.5.9.5	Roll axis control force limits-verification.....	511
5.5.9.5.1	Roll axis control force limits in steady turns-verification.....	511
5.5.9.5.2	Roll axis control force limits in dives and pullouts-verification.....	513
5.5.9.5.3	Roll axis control force limits in crosswinds-verification.....	514
5.5.9.5.4	Roll axis control force limits in steady sideslips-verification.....	515
5.5.9.5.5	Roll axis control force limits for asymmetric thrust-verification.....	516
5.5.9.5.6	Roll axis control force limits for failures-verification.....	517
5.5.9.5.7	Roll axis control force limits for configuration or control mode change-verification.....	518
5.6	Flying qualities requirements for the yaw axis-verification.....	539
5.6.1	Yaw axis response to yaw and side-force controllers-verification.....	539
5.6.1.1	Dynamic lateral-directional response-verification.....	539
5.6.1.2	Steady sideslips-verification.....	543
5.6.1.3	Wings-level turn -verification.....	553
5.6.2	Yaw axis response to roll controller-verification.....	580
5.6.3	Pilot-induced yaw oscillations-verification.....	584
5.6.4	Yaw axis control for takeoff and landing in crosswinds-verification.....	586
5.6.5	Yaw axis response to other inputs-verification.....	589
5.6.5.1	Yaw axis response to asymmetric thrust-verification.....	589
5.6.5.2	Yaw axis response to failures-verification.....	593
5.6.5.3	Yaw axis response to configuration or control mode change-verification.....	594
5.6.6	Yaw axis control power-verification.....	595
5.6.6.1	Yaw axis control power for takeoff, landing, and taxi-verification.....	597
5.6.6.2	Yaw axis control power for asymmetric thrust-verification.....	598
5.6.6.3	Yaw axis control power with asymmetric loading-verification.....	599
5.6.7	Yaw axis control forces-verification.....	600
5.6.7.1	Yaw control force limits in rolling maneuvers-verification.....	601
5.6.7.2	Yaw axis control force limits in steady turns-verification.....	602
5.6.7.3	Yaw axis control force limits during speed changes-verification.....	604
5.6.7.4	Yaw axis control force limits in crosswinds-verification.....	605
5.6.7.5	Yaw axis control force limits with asymmetric loading-verification.....	606
5.6.7.6	Yaw axis control force limits in dives and pullouts-verification.....	607
5.6.7.7	Yaw axis control force limits for waveoff (go-around)-verification.....	608
5.6.7.8	Yaw axis control force limits for asymmetric thrust during takeoff-verification.....	609
5.6.7.9	Yaw axis control force limits with flight control failures-verification.....	610
5.6.7.10	Yaw axis control force limits -- control mode change-verification.....	611
5.6.7.11	Yaw axis breakout forces-verification.....	612
5.7	Flying qualities requirements for the lateral flight path axis-verification.....	615
5.7.1	Dynamic response for lateral translation-verification.....	615
5.8	Flying qualities requirements for combined axes-verification.....	618
5.8.1	Cross-axis coupling in roll maneuvers-verification.....	618

MIL-STD-1797A

APPENDIX A CONTENTS

Paragraph Number	Title	Page
5.8.2	Crosstalk between pitch and roll controllers-verification.	620
5.8.3	Control harmony-verification.....	622
5.8.4	Flight at high angle of attack-verification.	626
5.8.4.1	Warning cues-verification.	631
5.8.4.2	Stalls-verification.	633
5.8.4.2.1	Stall approach-verification.	635
5.8.4.2.2	Stall characteristics-verification.	638
5.8.4.2.3	Stall prevention and recovery-verification.	640
5.8.4.2.4	One-engine-out stalls-verification.	643
5.8.4.3	Post-stall gyrations and spins-verification.	646
5.8.4.3.1	Departure from controlled flight-verification.....	650
5.8.4.3.2	Recovery from post-stall gyrations and spins-verification.	661
5.9	Flying qualities requirements in atmospheric disturbances-verification	670
5.9.1	Allowable flying qualities degradations in atmospheric disturbances-verification.	670
5.9.2	Definition of atmospheric disturbance model form-verification.....	692

MIL-STD-1797A

APPENDIX B CONTENTS

Paragraph Number	Title	Page
	Determining Equivalent Systems	688

APPENDIX C CONTENTS

Paragraph Number	Title	Page
	Background Information and Cross Reference	692
	Numerical cross-index of MIL-F-8785C to Appendix A	699

MIL-STD-1797A

FIGURES

Figure	Standard Page
FIGURE 1. Roll-sideslip coupling parameters--right rolls	10/11
FIGURE 2. Roll-Sideslip coupling parameters--left rolls. - continued	12/13

APPENDIX A FIGURES

Figure	Page
FIGURE 3.	Classification of aircraft (AFFDL-TR-69-72). 84
FIGURE 4.	Ground attack maneuver scenario. 87
FIGURE 5.	Response to a 1-second, half-stick aileron doublet for tracking scenario. 88
FIGURE 6.	Definition of Flying Quality Levels in Calm to Light Turbulence. 91
FIGURE 7.	Definition of Flight Envelope terms. 99
FIGURE 8.	Definition of Levels which include atmospheric disturbances as well as failures suggested by Carlson (AFFDL-TR-78-171). 127
FIGURE 9.	Buffet intensity rise determination from NASA-TP-1368. 141
FIGURE 10.	Control surface requirements. 153
FIGURE 11.	Control margin requirements. 155
FIGURE 12.	PIO tendency classification from AFWAL-TR-81-3118. 157
FIGURE 13.	Short-period dynamic requirements. 179
FIGURE 14.	Effect of fitting with $1/T_{\theta_2}$ fixed and free, Category C requirements. 183
FIGURE 15.	Envelopes of maximum unnoticeable added dynamics (AFWAL-TR-82-3064). 186
FIGURE 16.	Comparison of Bode amplitude plots for basic and augmented configurations of table XIII. 188
FIGURE 17.	Comparison of phase angles for basic and augmented configurations of table XIII. 188
FIGURE 18.	Effect of first- and second-order lags on equivalent time delay and pilot rating: LAHOS configurations (AFFDL-TR-78-122). 189
FIGURE 19.	Pilot control of pitch attitude and flight path. 190
FIGURE 20.	Definition of CAP from frequency response asymptotes. 192
FIGURE 21.	Pitch acceleration response to a unit step force input. 194
FIGURE 22.	Time delay versus CAP' - Neal-Smith data (from NADC-81186-60). 195
FIGURE 23.	Time delay versus CAP' - LAHOS data (from NADC-81186-60). 195
FIGURE 24.	Requirements for short-term pitch response to pitch controller ($\omega_{sp}T_{\theta_2}$ vs ζ_{sp}). 197
FIGURE 25.	Comparison of pilot ratings with category A short-period frequency requirements. 200
FIGURE 26.	Comparison of pilot ratings with Category A short-period damping requirements. 201
FIGURE 27.	Comparison of pilot ratings with Category A short-period frequency and damping ratio requirements. 202
FIGURE 28.	Category A C-5A flight test data. 203
FIGURE 29.	Alternate Category A flying qualities requirements for short-period pitch response. 203
FIGURE 30.	Comparison of pilot ratings with Category B short-period frequency requirements. 205
FIGURE 31.	Comparison of pilot ratings with Category B short-period damping requirements. 205
FIGURE 32.	Category B short-period characteristics. 206
FIGURE 33.	L-1011 climb short-period characteristics. 206
FIGURE 34.	L-1011 cruise short-period characteristics (AFWAL-TR-83-3015). 206
FIGURE 35.	L-1011 descent short-period characteristics (AFWAL-TR-83-3015). 206
FIGURE 36.	Alternative Category B short-period flying qualities requirements (NASA-TM-X-1584 data, Level 1 F_s/n). 207
FIGURE 37.	Comparison of pilot ratings with Category C short-period frequency requirements. 208
FIGURE 38.	Comparison of pilot ratings with Category C short-period damping requirements. 209

MIL-STD-1797A

APPENDIX A FIGURES

Figure	Page
FIGURE 39. Pilot ratings for large airplanes (nominal equivalent short-period parameters) from AFWAL-TR-81-3118.....	210
FIGURE 40. Category C flight data for the Lockheed C-5A and L-1011, AFWAL-TR-83-3015.	211
FIGURE 41. Time delay bands associated with flying qualities boundaries vs bandwidth, AFWAL-TR-81-3118.....	212
FIGURE 42. Alternate Category C short-period flying qualities requirements.	213
FIGURE 43. Comparison of LOES dynamics with short-period requirements; Category A, Neal-Smith (AFFDL-TR-70-74) configurations, MCAIR (MDC Rpt A6792) matches.....	215
FIGURE 44. Comparison of Neal-Smith LOES characteristics with $\omega_{sp} T_{\theta_2}$ vs ζ_{sp}	216
FIGURE 45. Comparison of LOES dynamics with short-period requirements; Category C, LAHOS (AFFDL-TR-78-122) configurations, MCAIR ("Equivalent Systems Approach for Flying Qualities Specification").	218
FIGURE 46. Comparison of LAHOS LOES characteristics with $\omega_{sp} T_{\theta_2}$ vs. ζ_{sp}	219
FIGURE 47. Comparison of effects of various stability characteristics on airplane response to elevator pulse (-5 deg for 0.2 sec at t = 0) (NASA-TM-X-62).....	220
FIGURE 48. Contours of constant pilot opinion in statically unstable region; constant stick-to-stabilizer gearing (NASA-TN-D-779).	221
FIGURE 49. Pitch rate response to step input of pitch controller force or deflection.	224
FIGURE 50. Comparison of YF-12 and XB-70 handling qualities evaluation with the GPAS results (NASA-CR-159236).....	227
FIGURE 51. Short-period frequency (NASA-CR-159236).	227
FIGURE 52. Pilot rating correlation with effective time delay (AFFDL-TR-78-122 data).	228
FIGURE 53. Pilot rating with effective time delay (AFWAL-TR-81-3116 data).	228
FIGURE 54. Pilot rating correlation with effective time delay (AFFDL-TR-78-122).	228
FIGURE 55. Pilot rating correlation with effective time delay (AFFDL-TR-68-90 data).	228
FIGURE 56. Pilot rating correlation with effective time delay (AFFDL-TR-70-74 data).	230
FIGURE 57. Bandwidth requirements.	231
FIGURE 58. Simplified pilot-vehicle closure for pitch control.	233
FIGURE 59. Definition of bandwidth frequency ω_{BW} from open loop frequency response.	235
FIGURE 60. Comparison of Neal-Smith data (AFFDL-TR-70-74) with bandwidth (mean ratings).	235
FIGURE 61a. Level 1/2 system of Neal-Smith (1D): $\omega_{BW} = 2.7$ rad/sec, mean PR = 4.1.....	236
FIGURE 61b. Level 3 system of Neal-Smith (2I) $\omega_{BW} = 2.5$ mean PR = 8.0.	236
FIGURE 62. Correlation of pilot ratings with ω_{BW} and τ_e (AFFDL-TR-70-74 data).....	237
FIGURE 63. Large difference in bandwidth due to shelf in amplitude plot with moderate values of τ_p (configurations of AFFDL-TR-78-122).....	238
FIGURE 64. Correlation of pilot ratings with ω_{BW} and τ_p for Neal-Smith data (Category A) (data from AFFDL-TR-70-74, ratings in parentheses from AFFDL-TR-74-9).....	239
FIGURE 65. Correlation of pilot ratings with ω_{BW} and τ_p for approach and landing (AFFDL-TR-122).	240
FIGURE 66. Comparison of pilot ratings for Category A short-period configurations with bandwidth (classical airplanes).	241
FIGURE 67. Comparison of pilot ratings for Category C short-period configurations with bandwidth (classical airplanes).	242
FIGURE 68. Design criteria for pitch dynamics with the pilot in the loop.	244
FIGURE 69. Amplitude-phase plot for configuration 13 (fwd; c.g.).	247

MIL-STD-1797A

APPENDIX A FIGURES

Figure	Page
FIGURE 70.	Amplitude-phase plot for configuration 12 (aft; c.g. - unstable)..... 247
FIGURE 71.	Amplitude-phase plot for configuration 6-1..... 248
FIGURE 72.	Amplitude-phase plot for configuration 6-2..... 248
FIGURE 73.	Pitch short period time responses..... 251
FIGURE 74.	Equivalent ω_n boundaries..... 252
FIGURE 75.	Design aim criteria for pitch attitude frequency response..... 252
FIGURE 76.	High and low order frequency response..... 253
FIGURE 77.	Trends of high order phase rate..... 253
FIGURE 78.	Flight path - attitude relationships..... 254
FIGURE 79.	n_z hang-on effects..... 254
FIGURE 80.	Precision tracking: $q \sim \theta$ trends..... 255
FIGURE 81.	New short-period thumbprint (from ICAS-86-5.3.4)..... 255
FIGURE 82.	Low-order pilot - aircraft attitude frequency response..... 256
FIGURE 83.	Comparison of equivalent delay effects in pitch or roll response to stick force for different simulations (from AIAA Paper 80-1611-CP)..... 260
FIGURE 84.	AFTI/F-16 independent back-up pitch rate feedback block diagram..... 261
FIGURE 85.	AFTI/F-16 $q \rightarrow \delta_e$ feedback (IBU)..... 262
FIGURE 86.	AFTI/F-16 $\theta \rightarrow F_s$ for IBU ($q \rightarrow \delta_e$ closed)..... 263
FIGURE 87.	Frequency and time response comparison..... 264
FIGURE 88.	Maximum pitch rate overshoot for a step control input (from DOT/FAA/CT-82/130-II)..... 266
FIGURE 89a.	Typical DFC control frequency sweep..... 269
FIGURE 89b.	Fourier transformed heading response..... 269
FIGURE 90.	Approach and landing, no pilot-induced oscillation, configuration P12 of AFWAL-TR-81-3116, medium offset approach (75 ft lateral, 50 ft vertical), landing no. 1 (from AIAA Paper 80-1611-CP)..... 270
FIGURE 91.	Pilot-induced oscillation at touchdown..... 271
FIGURE 92.	YF-17 pitch attitude dynamics (AFFDL-TR-77-57)..... 277
FIGURE 93.	YF-17 acceleration control system dynamics (AFFDL-TR-77-57)..... 278
FIGURE 94.	Effect of dither on B-1 limit cycle oscillations (from AFFTC-TR-79-2)..... 283
FIGURE 95.	Pilot rating vs pilot position - center of rotation (from AFWAL-TR-81-3118)..... 285
FIGURE 96.	Nosewheel and tailwheel lift-off..... 299
FIGURE 97.	Effect of arm/stick geometry on maximum push and pull capability by the right arm for the 5th percentile male (Human Engineering Guide to Equipment Design)..... 304
FIGURE 98.	Effect of upper arm angle on pull and push strength for the 5th and 95th percentile male (Human Engineering Guide to Equipment Design)..... 305
FIGURE 99.	Effect of arm position and wheel angle on maximum push and pull capability by the right arm for the 5th percentile male (Human Engineering Guide to Equipment Design)..... 306
FIGURE 100.	Elevator maneuvering force gradient limits: center-stick controller, $n_L = 7.0$ 311
FIGURE 101.	Elevator maneuvering force gradient limits: wheel controller, $n_L = 3.0$ 311
FIGURE 102.	OV-10A maneuvering control (AFFDL-TR-78-171)..... 312
FIGURE 103.	Longitudinal stick force at stall (AFFDL-TR-78-171)..... 312
FIGURE 104.	Short-period frequency vs longitudinal stick force per g (F_S / δ separately optimized) for a side-stick controller..... 313
FIGURE 105.	Comparison of optimum F_S/n with limits of table XVII (AFFDL-TR- 66-163, Category A; $n_L = 7g$)..... 314
FIGURE 106.	Comparison of optimum F_S/n with limits of table XVII (FDL-TDR- 64-60, Category C; $n_L = 3g$)..... 315
FIGURE 107.	Comparison of optimum F_S/n from data of Neal and Smith (AFFDL-TR-70-74) with limits of table XVII (Category A; $n_L = 7g$)..... 316

APPENDIX A FIGURES

Figure	Page
FIGURE 108. Comparison of optimum F_S/n from LAHOS (AFFDL-TR-78-122) data with limits of table XIV (Category C; $n_L = 7g$).....	317
FIGURE 109. Average pilot ratings for 1-lb/g segments of F_S/n	317
FIGURE 110. Comparison of F_S/n with limits of table XVII, wheel controllers (AFFDL-TR-68-91, Category A; $n_L = 3g$).....	318
FIGURE 111. Elevator control force gradients for transport aircraft (from AFFDL-TR-78-171).....	319
FIGURE 112. Comparison of F_S/n for various Class I airplanes in landing approach (Category C) with limits of table XVII.....	321
FIGURE 113. Illustration of resonance dip in F_S/n due to low ζ_{sp}	325
FIGURE 114. The ratio $(F_S/n)/(F_S/n)_{min}$ vs. ζ_{sp}	326
FIGURE 115. Sketch of effect of control system on resonant dip.....	326
FIGURE 116. Comparison of $(F_S/n)_{min}$ boundaries with $(F_S/n)_{SS}$ and ζ_{sp} for cases where $(\omega_{sp} \ll \omega_{cs})$ (AFFDL-TR-66-163).....	327
FIGURE 117. PIO tendency rating scale.....	328
FIGURE 118. T-33 data from AFFDL-TR-70-74 (Level 1 equivalent ω_{sp} , τ_e).....	329
FIGURE 119. PIO characteristics of A4D-2, T-38A, and F-4C (Douglas Aircraft Co. LB-25452, FTC-TR-67-19, and "Investigation and Elimination of PIO Tendencies in the Northrop T-38A").....	330
FIGURE 120. PIO characteristics of airplanes described in AGARD-CP-17.....	330
FIGURE 121. Pilot comments for air-to-air tasks with standard harmony (from AFFDL-TR-79-3126).....	334
FIGURE 122. Average pilot ratings for gross acquisition task.....	337
FIGURE 123. Average pilot ratings for fine tracking tasks.....	337
FIGURE 124. Control force per control displacement, Category A Flight Phases --centerstick (from AFFDL-TR-69-72).....	339
FIGURE 125. Landing approach (T-33, AFFDL-TR-66-2).....	367
FIGURE 126. Landing approach (T-33, AFFDL-TR-66-2).....	367
FIGURE 127. Landing approach (T-33, AFFDL-TR-66-2).....	368
FIGURE 128. Landing approach (T-33, AFFDL-TR-66-2).....	368
FIGURE 129. Carrier approach (Ground simulator experiment, "Simulator and Analytical Studies of Fundamental Longitudinal Control Problems in Carrier Approach").....	370
FIGURE 130. SST landing approach (Ground simulator experiments, NASA-TN-D-2251 and AFFDL-TR-65-227).....	370
FIGURE 131. Landing approach (AVRO 707, AGARD Rpt 420).....	371
FIGURE 132. Ratings versus roll damping - flight test, moving-base, fixed base with random input (from AFFDL-TR-65-138).....	384
FIGURE 133. Proposed roll performance requirements (MIL-F-8785) for Class III aircraft (from NADC-ED-6282).....	386
FIGURE 134. Lateral control boundaries (from Princeton Univ Rpt 727).....	386
FIGURE 135. Lateral flying qualities boundaries (L_β vs. T_R , $\zeta_d = 0.1$) (from Princeton Univ Rpt 727).....	387
FIGURE 136. Lateral flying qualities boundaries (L_β vs. T_R , $\zeta_d = 0.4$) (from Princeton Univ Rpt 727).....	387
FIGURE 137. Pilot ratings and optimum aileron sensitivity (Medium $ \phi/\beta _d$, Long T_R) (from AFFDL-TR-67-98).....	388
FIGURE 138. Variation of pilot opinion with $L\delta_a\delta a_{max}$, for constant values of T_R as obtained from the stationary flight simulator (from NASA Memo 1-29-59A).....	389
FIGURE 139. Variation of pilot opinion with $L\delta_a\delta a_{max}$, for constant values of T_R as obtained from the moving flight simulator (from NASA Memo 1-29-59A).....	389

APPENDIX A FIGURES

Figure	Page
FIGURE 140. Comparison of pilot opinion boundaries obtained from the fixed and moving flight simulators (from NASA Memo 1-29-59A).....	390
FIGURE 141. Range of parameters $L\delta_a\delta a_{max}$ and T_R covered in the flight investigation, shown in comparison with the motion simulator driven boundaries (from NASA Memo 1-29-59A).....	390
FIGURE 142. Comparison of in-flight pilot-opinion rating with those predicted from flight simulator boundaries (from NASA Memo 1-29-59A).....	391
FIGURE 143. Pilot rating versus roll mode time constant (from WADD-TR-61-147).....	392
FIGURE 144. Average pilot rating of roll mode time constant (from AFFDL-TR-65-39).....	392
FIGURE 145. Effect of roll mode LATHOS (AFWAL-TR-81-3171), Category A.....	394
FIGURE 146. Comparison of models and data for closed-loop stick deflection responses under lateral vibration (AMRL-TR-73-78).....	394
FIGURE 147. Effect of $1/T_R$ on high-frequency gain.....	395
FIGURE 148. Limits of satisfactory and tolerable rates of spiral divergence (from Cornell Aero Lab TB-574-F-6).....	399
FIGURE 149. Data for all types of flying pilot opinion versus spiral damping (from Cornell Aero Lab TB-1094-F-1).....	400
FIGURE 150. Composite pilot ratings for spiral descent of simulated reentry vehicle (from NASA-CR-778).....	404
FIGURE 151. Composite pilot ratings for up-and-away flight; moderate $ \phi/\beta _d$ (from NASA-CR-778).....	405
FIGURE 152. Composite pilot ratings for up-and-away flight; large $ \phi/\beta _d$ (from NASA-CR-778).....	405
FIGURE 153. Pilot ratings for ground simulation of NASA-TN-D-5466 (Dutch roll characteristics vary).....	406
FIGURE 154. Pilot ratings for ground simulation of AFFDL-TR-65-39 [$(\omega_\phi/\omega_d)^2 = 0.64 - 1.10$].....	406
FIGURE 155. Coupled roll-spiral mode characteristics for M2-F2 and M2-F3 lifting bodies (from NASA-TN-D-6496).....	407
FIGURE 156. Roll rate oscillation limitations.....	411
FIGURE 157. Bank angle oscillation limitations.....	411
FIGURE 158. Effect of relative pole/zero location on piloted control of bank angle.....	414
FIGURE 159. Locations of ω_ϕ , zero corresponding to Category A and C and Level 1 and 2 boundaries on figure 156 ($T_R = 0.5$ sec, $T_S = \infty$) (from AFFDL-TR-69-72).....	415
FIGURE 160. P_{osc}/P_{av} , as a function of the ratio of dutch roll period and spiral root time constant (from AFFDL-TR-72-41).....	416
FIGURE 161. Flight phase Category A data, moderate $ \phi/\beta _d$ (from AFFDL-TR-67-98).....	418
FIGURE 162. Flight phase Category A data, large and small $ \phi/\beta _d$ (from AFFDL-TR-67-98).....	418
FIGURE 163. Flight phase Category B data (from NASA-CR-778).....	419
FIGURE 164. Flight phase Category B data (from WADD-TR-61-147).....	419
FIGURE 165. Flight phase Category C data (from Princeton Univ Rpt 727).....	420
FIGURE 166. Category C data (approach and wave-off); Cooper-Harper pilot ratings (from AFFDL-TR-70-145).....	420
FIGURE 167. Positive and negative dihedral data of Princeton Univ Rpt 604.....	421
FIGURE 168. Effect of time delay, LATHOS data (AFWAL-TR-81-3171).....	426
FIGURE 169. Pilot rating vs. time delay -- lateral-directional.....	426
FIGURE 170. Lateral acceleration criterion versus pilot rating from NASA-CR-159236.....	431
FIGURE 171. Pilot rating vs lateral acceleration criteria.....	432
FIGURE 172. Roll control effectiveness parameters for Class III aircraft, Category C.....	447
FIGURE 173. C-5A flight test data (from AFFDL-TR-75-3).....	448

MIL-STD-1797A

APPENDIX A FIGURES

Figure	Page
FIGURE 174. Roll performance for Class III aircraft (from AFFDL-TR-78-171).....	450
FIGURE 175. Comparison of pilot ratings for Class III aircraft in Category B Flight Phases with requirements of table XXIX (NASA-TN-D-5957).	452
FIGURE 176. Time to bank, 300 for CV-990 (NASA-TN-D-6811).	453
FIGURE 177. F-4 roll control effectiveness, time-to- bank 90°, CR configuration (from AFFFDL-TR-70-155).	454
FIGURE 178. F-4 roll control effectiveness, time-to- bank 90°, CR configuration (from AFFFDL-TR-70-155).	454
FIGURE 179. F-4 roll control effectiveness; CO configuration. Limits shown for speed range M, table XXXII (from AFFDL-TR-70-155).	455
FIGURE 180. F-5E roll performance at 0.8 nL, configuration CO (from AFFDL-TR-78-171).	456
FIGURE 181. F-14A rolling performance in configuration PA; DLC on (from Navy Rpt No. SA-C7R-75).	457
FIGURE 182. F-15C aileron roll characteristics (from AFFTC-TR-80-23).	457
FIGURE 183. Time to roll 90° versus match for F/A-18A (Navy Rpt No. SA-14R-81).....	458
FIGURE 184. Time to roll 360° versus match for F/A-18A (Navy Rpt No. SA-14R-81).....	458
FIGURE 185. Roll performance characteristics in configuration PA (from Navy Rpt No. SA-14R-81).....	461
FIGURE 186. YF-16 rolling performance in cruise configuration; AFFTC-TR-75-15.....	462
FIGURE 187. Roll performance summary (from AFFTC-TR-79-10).....	463
FIGURE 188. Roll performance summary (from AFFTC-TR-79-10).....	465
FIGURE 189. Effect of arm/stick geometry on maximum applied force to the left and to the right by the right arm for the 5th percentile male (Human Engineering Guide to Equipment Design).....	477
FIGURE 190. Effect of upper arm angle on maximum applied force to the left and to the right for the 5th and 95th percentile male (from Human Engineering Guide to Equipment Design)	478
FIGURE 191. Effect of arm position and wheel angle on maximum applied force to to the left and to the right for the 5th percentile male (Human Engineering Guide to Equipment Design).	479
FIGURE 192. Variation of pilot rating with bank angle in the first second for four values of effective angle (from (NASA-CR-635).....	481
FIGURE 193. Block diagram representation of full-authority roll rate command augmentation systems.	485
FIGURE 194. Range of acceptable nonlinear roll command shaping networks based on flight tests (Class IV aircraft, Flight Phase Category A, right roll).....	486
FIGURE 195. Comparison of P _{max} /F _{as} for several conventional Class IV aircraft with CAS curves of figure 194.....	487
FIGURE 196. Evolution of the F-16 CAS shaping network.	488
FIGURE 197. YF-16 PIO due to excessive lateral stick sensitivity (from AFFTC-TR-75-15).....	489
FIGURE 198. Roll ratchet during banking maneuvers (DIGITAC, AFFTC-TR-76-15) h = 20,000 ft. M = 0.75.	491
FIGURE 199. Evolution of roll CAS network for YA-7D DIGITAC (AFFTC-TR-76-15).....	492
FIGURE 200. Steady rolls on YF-16 (AFFTC-TR-75-15).....	493
FIGURE 201. Roll ratcheting experienced on LATHOS (AFWAL-TR-81-3171) Configuration 5-2.....	495
FIGURE 202. Roll gradients for LATHOS configurations 5-2 and 5-3 (T _R = 0.15 sec) compared with acceptable range from figure 194.....	496
FIGURE 203. Influence of prefilter lag on pilot ratings (AFWAL-TR-81-3171).	

MIL-STD-1797A

APPENDIX A FIGURES

Figure	Page
	$T_R = 0.15$ sec..... 496
FIGURE 204.	Typical roll sensitivity - high gain. 497
FIGURE 205.	Flight Phase Category A - force sensitivity. 498
FIGURE 206.	Pilot ratings from NASA Memo 1-29-59A (Category A Flight Phase)..... 500
FIGURE 207.	Flight Phase Category C - force sensitivity (from Princeton Univ Rpt 727). 501
FIGURE 208.	Effect Of ζ_d on pilot ratings for in-flight and fixed-base simulations of NASA-TN-D-1141 $\omega_d = 1.78 - 1.90$ rad/sec (Category B)..... 514
FIGURE 209.	Dutch roll data (from Cornell Aero Lab Rpt TB-574-F-3). 514
FIGURE 210.	Dutch roll data (from IAS Paper 60-18). 515
FIGURE 211.	Dutch roll data from fixed-base simulation of re-entry task (ASD-TDR-61-362) $T_R \approx 0.40$ sec, $T_S \approx \infty$ 516
FIGURE 212.	Dutch roll data (from NASA-CR-778; low $\omega_d^2 \phi / \beta _d$ 518
FIGURE 213.	Dutch roll data (from NASA-CR-778; high $\omega_d^2 \phi / \beta _d$ 519
FIGURE 214.	Dutch roll data (from WADD-TR-61-147). 520
FIGURE 215.	Data for high $\omega_d^2 \phi / \beta _d$ (from WADD-TR-61-147). 520
FIGURE 216.	Dutch roll data from in-flight simulation of AFFDL-TR-67-98..... 521
FIGURE 217.	Dutch roll data from flight tests of NASA Memo 12-10-58A (F-86E; low-frequency data). 522
FIGURE 218.	Dutch roll data from flight tests of NASA Memo 12-10-58A (F-86E; high-frequency data). 522
FIGURE 219.	Dutch roll data from in-flight simulation of Princeton Univ Rpt 797 (Navion; pilot ratings shown for optimum values of L_β). 523
FIGURE 220.	Dutch roll data from In-flight simulation of Class II-L airplanes in landing approach (T-33; AFFDL-TR-70-145). 524
FIGURE 221.	Dutch roll data from moving-base - bank simulator tests of NASA- TN-D-3910 (supersonic transport). 524
FIGURE 222.	Variation of pilot rating with ω_ϕ / ω_d for moving-base simulator and flight data $\zeta_d \approx 0.15$ (NASA-TN-D-3910). 525
FIGURE 223.	$\Delta \zeta \omega / \Delta (\omega_d^2 \phi / \beta _d)$ required to maintain a given basic rating (from AFFDL-TR-70-145), based upon data of figures 224 and 225. 526
FIGURE 224.	Dutch roll data from controls-fixed rudder kicks of WADC-TR-52-298 compared to limits of table XL..... 527
FIGURE 225.	Data upon which relation of figure 223 are based (controls-fixed rudder kicks, WADC-TR-52-298; figure reproduced from AFFDL-TR-65-138). 528
FIGURE 226.	Dutch roll data on existing airplanes (from AGARD-CP-17). 529
FIGURE 227.	Lateral directional damping for some Class III airplanes (from AFFDL-TR-78-171). 530
FIGURE 228.	Finding the dutch roll envelope. 533
FIGURE 229.	Definition of bandwidth frequency. 540
FIGURE 230.	Effect of DFC manipulator sensitivity configuration WLT1 (very low coupling) (from AFWAL-TR-81-3027). 540
FIGURE 231.	Effect of DFC manipulator sensitivity configuration WLT5 (high favorable yaw coupling) (from AFWAL-TR-81-3027). 541
FIGURE 232.	Effect of DFC manipulator sensitivity -- configuration WLT12 (very high favorable roll coupling) (from AFWAL-TR-81-3027). 542
FIGURE 233.	Correlation of pilot ratings with heading bandwidth; wings-level turn mode; air-to-air tracking task. 543
FIGURE 234.	Correlation of pilot ratings with heading bandwidth for conventional aircraft; ILS approach task. 544

MIL-STD-1797A

APPENDIX A FIGURES

Figure	Page
FIGURE 235. Sideslip excursion limitations for small roll control commands.....	546
FIGURE 236. Pilot ratings and optimum aileron sensitivity (low $ \phi/\beta _d$, medium T_R) (AFFDL-TR-67-98).....	548
FIGURE 237. Flight Phase Category A data from AFFDL-TR-67-98.....	549
FIGURE 238. Flight Phase Category A data from AFFDL-TR-67-98 ($\Delta\beta/k$, ψ_β from AFFDL-TR-72-41).....	551
FIGURE 239. $\Delta\beta_{max}/k$ versus ψ_β for evaluation points that meet Level 1 p_{osc}/p_{av} criteria, Category A data (from AFFDL-TR-72-36).....	552
FIGURE 240. Category B data of WADD-TR-61-147.....	553
FIGURE 241. Category C configurations of Princeton Univ Rpt 727 ($\Delta\beta/k$, ψ_β from AFFDL-TR-72-41).....	554
FIGURE 242. $\Delta\beta_{max}/k$ versus ψ_β for configurations that meet Level 1 p_{osc}/p_{av} , ζ_d , and $\zeta_d\omega_d$ criteria (from AFFDL-TR-70-145).....	554
FIGURE 243. C-5A flight test data (from AFFDL-TR-75-3).....	556
FIGURE 244. Sideslip excursion data for Class III aircraft in Category B Flight Phases (from AFFDL-TR-78-171).....	557
FIGURE 245. Sideslip excursions for F4H-1 airplane (from AFFDL-TR-70-155).....	558
FIGURE 246. F-5A flight test data.....	559
FIGURE 247. Crossfeed parameter boundaries.....	560
FIGURE 248. Pilot rating boundaries for acceptable roll control in turbulence with $ \dot{r}_o/\dot{p}_o \leq 0.03$ (from Princeton Univ Rpt 797).....	562
FIGURE 249. Bode asymptotes and time response of crossfeed.....	565
FIGURE 250. Effect of removing high-frequency roots from numerators.....	568
FIGURE 251. Required crossfeed for $\dot{r}_o = 0$	569
FIGURE 252. Pilot rating correlations when \dot{r}_o/\dot{p}_o is small.....	570
FIGURE 253. Pilot rating correlation with crossfeed parameters.....	573
FIGURE 254. Required aileron-rudder sequencing for several operational aircraft, SAS/CAS ON (from Systems Technology, Inc., TR-1090-1).....	574
FIGURE 255. Time history of aft-c.g. deep stall encountered by F-16B..... (AFFTC-TR-79-18).....	633
FIGURE 256. Anti-spin SAS for F-16B ($\alpha \geq 29$ deg).....	634
FIGURE 257. Modified departure rating scale (MOD II).....	639
FIGURE 258. Dynamic stability design guide suggested by Titiriga..... (AGARD-CP-199).....	644
FIGURE 259. Departure and spin susceptibility criterion suggested by ASD-TR-72-48 and AFWAL-TR-80-3141.....	645
FIGURE 260. Departure susceptibility rating versus lateral closed-loop divergence potential (from AFWAL-TR-80-3141).....	647
FIGURE 261. Left flat spin, F-4B (from AFFDL-TR-70-155).....	652
FIGURE 262. Turbulence severity and exceedance probability.....	658
FIGURE 263. Probability of exceeding mean wind speed at 20 ft.....	660
FIGURE 264. Earth-axis winds.....	666
FIGURE 265. Magnitude of discrete gusts.....	668
FIGURE 266. Low-altitude turbulence integral scales.....	670
FIGURE 267. Horizontal turbulence RMS intensities.....	670
FIGURE 268. CVA ship burble steady wind ratios.....	672
FIGURE 269. u-component burble time constant and variance.....	674
FIGURE 270. Comparative approximate frequency regimes of mission/aircraft-centered and atmospheric disturbance features.....	686
FIGURE 271. Simplified flow chart for equivalent system computer program.....	691

MIL-STD-1797A

APPENDIX A FIGURES

Figure	Page
FIGURE 272. Flow Chart for a modified Rosenbrock search algorithm.....	692
FIGURE 273. Example step-and-ramp HUD tracking sequences.....	108n
FIGURE 274. Typical ATLAS light pattern (from NASA TM 101700)	108p
FIGURE 275. Adequate and desired performance for 4950 th boom tracking task (from 4950-FTR-93-05)	108q
FIGURE 276. Variation of crossover frequency with pitch attitude dynamics (from AFFDL-TR-65-15)	269
FIGURE 277. Specification of the criterion frequency.....	269

MIL-STD-1797A

TABLES

Table		Standard Page
TABLE I.	Operational Flight Envelope.....	21
TABLE II.	Aircraft Normal States.....	24
TABLE III.	Levels for Aircraft Failure States.....	25
TABLE IV.	Pitch trim change conditions.....	32
TABLE V.	Flying qualities in atmospheric disturbances for Aircraft Normal States.....	47
TABLE VI.	Flying qualities in atmospheric disturbances for Aircraft Failure States.....	48

MIL-STD-1797A

APPENDIX A TABLES

Table	Page
TABLE I.	Operational Flight Envelope..... 102
TABLE III.	Levels for Aircraft Failure States..... 119
TABLE V.	Flying qualities in atmospheric disturbances for Aircraft Normal States..... 655
TABLE VI.	Flying qualities in atmospheric disturbances for Aircraft Failure States..... 655
TABLE VII.	Operational flight Envelope values..... 112
TABLE VIII.	Recommended Levels for Aircraft Failure States..... 120
TABLE IX.	Summary of minimum allowable intervention times for system failures..... 154
TABLE X.	Control-margin increments..... 163
TABLE XI.	Control surface lags..... 175
TABLE XII.	Examples of variations in LOES parameters with $1/T_{\theta_2}$ fixed and free..... 181
TABLE XIII.	Lead/lag configurations with Level 1 LOES and Level 2 pilot ratings..... 187
TABLE XIV.	Classification of some known PIO cases (from NOR-64-143)..... 291
TABLE XV.	Pitch trim change conditions..... 298
TABLE XVI.	Maximum forces exerted on aircraft control stick (lb) by men and women (AFAMRL-TR-81-39)..... 315
TABLE XVII.	Pitch maneuvering force gradient limits..... 319
TABLE XVIII.	Category A control configurations for T-33 sidestick evaluations (AFFDL-TR-79-3126)..... 345
TABLE XIX.	Experimental test points used in sidearm controller evaluations..... 346
TABLE XX.	Recommended pitch axis breakout forces (lb)..... 352
TABLE XXI.	Recommended force limits for dives and recovery from dives..... 358
TABLE XXII.	Guidance for lower limit on $1/T_{\theta_2}$ 370
TABLE XXIII.	Conversion of $\omega_{sp} T_{\theta_2}$ to a phase angle criterion..... 371
TABLE XXIV.	Recommended maximum roll-mode time constant (seconds)..... 393
TABLE XXV.	Spiral stability -- recommended minimum time to double amplitude..... 408
TABLE XXVI.	Recommended minimum values for roll-spiral damping coefficient, $\zeta_{RS} \omega_{RS}$ 412
TABLE XXVII.	Recommended allowable equivalent delay..... 435
TABLE XXVIII.	Roll performance for Class I and II aircraft..... 451
TABLE XXIX.	Roll performance for Class III aircraft..... 451
TABLE XXX.	Roll performance for Class IV aircraft..... 453
TABLE XXXI.	Flight phase CO roll performance in nominal 1-g rolls..... 453
TABLE XXXII.	Flight phase CO roll performance, $n > 1$ 454
TABLE XXXIII.	Flight phase GA roll performance..... 454
TABLE XXXIV.	YF-16 roll performance (from AFFTC-TR-75-15)..... 469
TABLE XXXV.	Maximum forces exerted on aircraft control stick (lb) by 61 men and 61 women (AFAMRL-TR-81-39)..... 488
TABLE XXXVI.	Recommended maximum roll control force..... 492
TABLE XXXVII.	Recommended maximum roll control sensitivity for stick- controlled aircraft..... 494
TABLE XXXIX.	Recommended allowable breakout forces (lb)..... 512
TABLE XL.	Recommended minimum dutch roll frequency and damping..... 522
TABLE XLI.	Recommended bandwidth limits for wings-level turn mode..... 548
TABLE XLII.	Aircraft parameters subject to bandwidth limitation for wings- level turn mode..... 548
TABLE XLIII.	Recommended maximum sideslip excursions for large roll control commands..... 557
TABLE XLIV.	Limits on δ'_{rp} (3) for $ \dot{r}_o/\dot{p}_o < 0.07$ 570
TABLE XLV.	Ground rules for application of rating data to heading control criteria..... 571
TABLE XLVI.	Parameters defining the LOS representation of the aileron-rudder crossfeed..... 576

MIL-STD-1797A

APPENDIX A TABLES

Table		Page
TABLE XLVII.	Physical interpretation of μ	578
TABLE XLVIII.	Summary of current data.	581
TABLE XLIX.	Recommended minimum crosswind velocity requirements.....	587
TABLE L.	Summary of Cooper-Harper pilot ratings for lateral translation mode.	616
TABLE LI.	Digest of pilot comments on specific aircraft high-AOA flying characteristics (from AFWAL-TR-81-3108).....	629
TABLE LI.	Digest of pilot comments on specific aircraft high-AOA flying characteristics (from AFWAL-TR-81-3108)	630
TABLE V.	Flying qualities in atmospheric disturbances for Aircraft Normal States.....	665
TABLE VI.	Flying qualities in atmospheric disturbances for Aircraft Failure States.	665
TABLE LII.	Recommended values for table V.....	666
TABLE LIII.	Recommended values for table VI.....	667
TABLE LIV.	Digital filter implementation.....	675
TABLE LV.	Examples of practical implemental matters.	688
TABLE LVI.	A Survey of atmospheric disturbance models.	691
TABLE LVII.	Linearized gust derivative terms in airframe dynamics.....	695

MIL-STD-1797A
APPENDIX A

AFFDL-TR-70-74 Vols I and II	An In-Flight Investigation to Develop Control System Design Criteria for Fighter Airplanes; Neal, T. P. and Rogers E. Smith, December 1970
AFFDL-TR-70-145	An In-Flight Investigation of Lateral-Directional Dynamics for the Landing Approach; Hall, G. W. and E. M. Boothe; October 1971
AFFDL-TR-70-155	Validation of the Flying Qualities Requirements of MIL-F-00878SA(USAF); Brady, C. C. and J. Hodgkinson; January 1971
AFFDL-TR-71-134	Validation of the Flying Qualities Requirements of MIL-F-8785B(ASG), Kandalraft, R. N.; September 1971
AFFDL-TR-71-164 Vol I	In-Flight Investigation of an Unaugmented Class III Airplane in the Landing Approach Task. Phase I: Lateral-Directional Study; Wasserman, R., F. F. Eckhart and H. J. Ledder; January 1972
AFFDL-TR-72-36	Evaluation of Lateral-Directional Handling Qualities and Roll-Sideslip Coupling of Fighter Class Airplanes; Boothe, E. M. and M. L. Parrag, May 1972
AFFDL-TR-72-41	Revisions to MIL-F-8785B(ASG) Proposed by Cornell Aeronautical Laboratory Under Contract F33615-71-C-1254; Chalk, C. R., D A. DiFranco, et al.; April 1973
AFFDL-TR-72-141 Vol I	Validation of the Flying Qualities Requirements of MIL-F-8785B(ASG) Using the P-3B Airplane; Richards, R. B., D. L. Green and J. C. Rennie, November 1973
AFFDL-TR-72-143	In-Flight Simulation of Minimum Longitudinal Stability for Large Delta-Wing Transports in Landing Approach and Touchdown. Vol 1: Technical Results; Wasserman, R. and J. F. Mitchell; February 1973
AFFDL-TR-73-76	Recommended Revisions to Selected Portions of MIL-F-8785B(ASG) and Background Data; Ashkenas, I. L., R. H. Hoh and S. J. Craig; August 1973
AFFDL-TR-74-9	A Two-Phase Investigation of Longitudinal Flying Qualities for Fighters; Boothe, E. M., R. T. N. Chen and C. R. Chalk; April 1974
AFFDL-TR-74-61	Investigation of Flying Qualities of Military Aircraft at High Angles of Attack. Vol 1: Technical Results; Johnston, D. E., I. L. Ashkenas and J. R. Hogge; June 1974
AFFDL-TR-74-130 (2 Vols)	Extension of the Method for Predicting Six-Degree-of-Freedom Store Separation Trajectories at Speeds Up to the Critical Speed to Include A Fuselage with Noncircular Cross Section; Dillenius, M. F. E., F. K. Goodwin and J. N. Nielsen; November 1974
AFFDL-TR-75-3	Evaluation of the Flying Qualities Requirements of MIL-F-8785B(ASG) Using the C-5A Airplane-, Silvers, C. L. and C. C. Withers; March 1975
AFFDL-TR-76-78	Direct Side Force Control Criteria for Dive Bombing. Vol 1: Summary Vol II: Analysis and Results; Brulle, R. V., W. A. Moran and R. G Marsh; September 1976

MIL-STD-1797A
APPENDIX A

AFFDL-TR-77-34 Limited-Flight Evaluation of Sidestick Controller Force-Deflection Characteristics on Aircraft Handling Qualities; Cima, William M., et al.; Nov 1977

AFFDL-TR-77-57 A Theory for Longitudinal Short-Period Pilot Induced Oscillations; Smith, Ralph H.; June 1977

AFFDL-TR-78-9 Fighter CCV Phase IV Report, Vol II: Flight Test Data Evaluation. Vol III: Test Phase Data Summary, Parts I and 2; McAllister, J. D., et al.; February 1978

AFFDL-TR-78-122 Effects of Control System Dynamics on Fighter Approach and Landing Longitudinal Flying Qualities (Volume I); Smith, Rogers E.; March 1978

AFFDL-TR-78-154 Handling Quality Requirements for Advanced Aircraft Design: Longitudinal Mode; Smith, Ralph H. and Norman D. Geddes; Aug 1979

AFFDL-TR-78-171 Proceedings of AFFDL Flying Qualities Symposium Held at Wright State University 12-15 September, 1978; Black, G. T., Moorhouse, D. J., et al., compilers; December 1978:

“Task-Oriented Flying Qualities for Air-to-Ground Gun Attack;” Brandeau, G.

“B-1 Experience Related to MIL-F-8785B and Proposed Revisions;” Campbell, J. E.

“An Approach to Simplify the Specification of Low-Speed Maneuvering Pitch Control Force;” Cichy, D. R.

“High Angle of Attack Flying Qualities and Departure Criteria Development;” Hellman, G. K. and R. B. Crombie

“Northrop Review of MIL-F-8785B Proposed Revision;” Lockenour, J

“Evaluation of Selected Class III Requirements of MIL-F-8785B(ASG), ‘Flying Qualities of Piloted Airplanes;’” Withers, C. C.

“Flying Qualities of Piloted Airplanes;” Withers, C. C.

“Discussion and Status of the Proposed Revision (1978) to MIL-F-8785B;” Moorhouse, D. J., R. J. Woodcock and T. P. Sweeney

AFFDL-TR-79-3126 Flight Qualities Design Requirements for Sidestick Controllers; Black, G. T. and D. J. Moorhouse; October 1979

MIL-STD-1797A
APPENDIX A

AFWAL-TR-80-3032 Prediction of Supersonic Store Separation Characteristics Including Fuselage and Stores of Noncircular Cross Section (4 volumes); Goodwin, F. K., M. F. E. Dillenius and J. Mullen. Jr.; November 1980

AFWAL-TR-80-3060 Simulation Analysis: Unorthodox Control Force Fighter Aircraft, Vol II: Detailed Summary; Mitchell, A. L., et al.; April 1980

AFWAL-TR-80-3067 Flying Qualities Design Criteria: Proceedings of AFFDL Flying Qualities Symposium Held at Wright-Patterson Air Force Base in October 1979. Crombie, R. B. and D. J. Moorhouse, compilers; May 1980

AFWAL-TR-80-3141 Investigation of High-Angle-of-Attack Maneuvering - Limiting Factors, Part 1: Analysis and Simulation; Johnston, D. E., D. G. Mitchell and T T. Myers; December 1980

AFWAL-TR-81-3027 Development of Handling Quality Criteria for Aircraft with Independent Control of Six-Degrees-of-Freedom; Hoh, R. H., T. T. Myers, et al.; April 1981

AFWAL-TR-81-3090 Notes on Lateral-Directional Pilot Induced Oscillations; Sith, Ralph H.; Mar 1982

AFWAL-TR-81-3108 Investigation of High AOA Flying Qualities and Design Guides; Johnston, D. E. and R. K. Heffley; December 1981

AFWAL-TR-81-3109 Background Information and User Guide for MIL-F-8785C. Military Specification - Flying Qualities of Piloted Airplanes; Moorhouse, D J. and R. J. Woodcock; September 1981

AFWAL-TR-81-3116 Equivalent System Verification and Evaluation of Augmentation Effects on Fighter Approach and Landing Flying Qualities; Smith, Rogers E.; September 1981

AFWAL-TR-81-3118 In-Flight Investigation of Large Airplane Flying Qualities for Approach and Landing; Weingarten, N. C. and C. R. Chalk; September 1981

AFWAL-TR-81-3171 Lateral Flying Qualities of Highly Augmented Fighter Aircraft, Vols. I and 11; Monegan, S. J., Rogers E. Smith and R. E. Bailey; June 1982

AFWAL-TR-82-3014 Proposed Revisions to MIL-F-8785C Related to Flight Safety of Augmented Aircraft, 3 Vols.; Schuler, J. M. and M A. Dahl, April 1982

AFWAL-TR-82-3064 Design Criteria for the Future of Flight Controls, Proceedings of the Flight Dynamics Laboratory Flying Qualities and Flight Control Symposium, 2-5 March, 1982; Fuller, S. G. and Potts, D. W., compilers; July 1982

AFWAL-TR-82-3081 Proposed MIL Standard and Handbook - Flying Qualities of Air Vehicles, Vol II: Proposed MIL Handbook; Hoh, R. H., Mitchell, D. G., et al November 1982

MIL-STD-1797A
APPENDIX A

AFWAL-TR-83-3015 Suggested Revisions to MIL-F-8785C for Large Class III Aircraft; Nleyer, R. T., et al.; February 1983

AFWAL-TR-86-3093 Proceedings of the Twenty-Second Annual Conference on Manual Control, Dec 1986
"Test Pilot Evaluation of the Closed-Loop GRATE Flight Test Technique;" Biezd, Daniel J. and Steven R. Sturmer

AFWAL-TM-87-180-FIGC S/MTD Series IV Manned Simulation: An Air Force Evaluation of S/MTD Flaps Down Operation; Leggett, David B., et al.; Aug 1987

AFFDL-FGC-TM-71-7 Validation of the Handling Qualities Degradation Probabilities of MIL-F-008785A Using F-4C Air Force Manual 66-1 Maintenance Data, Ullman, Lt., T. Calanducci, and Lt. Linck; August 1971

AFAMRL-TR-73-78 Manual Control Performance and Dynamic Response During Sinusoidal Vibration; Allen, R. Wade, Henry R. Jex, and Raymond E. Magdaleno, October 1973

AFAMRL-TR-81-39 Male and Female Strength Capabilities for Operating Aircraft Controls; McDaniel, Joe W.; March 1981

AFFTC-SD-69-5 A-7D Stability and Control Military Preliminary Evaluations (Phase IA and IB); Gobert, Don O. and William T. Twinting; April 1969

AFFTC-TD-75-1 Tracking Test Techniques for Handling Qualities Evaluation; Twisdale, T R. and D. L. Franklin; May 1975

AFFTC-TR-75-15 Flying Qualities Evaluation of the YF-16 Prototype Lightweight Fighter, Eggers, James A. and William F. Bryant, Jr.; July 1975

AFFTC-TR-75-32 F-15A Approach-to-Stall/Stall/Post-Stall Evaluation; Wilson, Donald B and Charles A. Winters; January 1976

AFFTC-TR-76-15 Flight Test Development and Evaluation of a Multimode Digital Flight Control System Implemented in an A-7D (DIGITAC), Damman, Lawrence, Robert Kennington, Paul Kirsten, Ronald Grabe, and Patrick Long; June 1976

AFFTC-TR-77-11 A-10A Flying Qualities Air Force Developmental Test and Evaluation; Stewart, Will R., et al; Jul 1975

AFFTC-TR-77-23 YF-16 Control Configured Vehicle (CCV) Operational Potential, Flying Qualities, and Performance Evaluation; Wood, Richard A., et al; Jan 1978

AFFTC-TR-77-27 System Identification from Tracking (SIFT), a New Technique for Handling Qualities Test and Evaluation (Initial Report); Twisdale, T. R and T. A. Ashurst; November 1977

AFFTC-TR-79-2 Flying Qualities and Flight Control System Evaluation of the B-1 Strategic Bomber; Ross, Jerry L., Page G. McGirr, and Otto J. Waniczek, Jr.; May 1979

AFFTC-TR-79-10 F-16A/B Flying Qualities Full-Scale Development Test and Evaluation; Pape, James A. and Michael P. Garland; September 1979

MIL-STD-1797A
APPENDIX A

AFFTC-TR-79-18	F-16A/B High Angle of Attack Evaluation; Wilson, Donald B. and Robert C. Ettinger; October 1979
AFFTC-TR-80-23	F-15C Flying Qualities Air Force Development Test and Evaluation; Shaner, Keith L. and Robert W. Barham; November 1980
AFFTC-TR-80-29	F-16 Flying Qualities with External Stores; Garland, Michael P., Michael K. Nelson, and Richard C. Patterson; February 1981
AFFTC-TR-83-45	AFTI/F-16 Handling Qualities Evaluation; Sorokowski, Paul J., et al; Feb 1984
AFFTC-TR-91-29	STOL/Maneuver Technology Demonstrator Flying Qualities and Integrated Flight/Propulsion Control System Evaluation; Crawford, Mark R. and Michael J. Costigan; Dec 1991
AFFTC-TLR-93-41	Human Pilot Response During Single- and Multi-Axis Tracking Tasks; Edkins, Craig R.; Dec 1993
FDL-TDR-64-60	Flight Evaluation of Various Short Period Dynamics at Four Drag Configurations for the Landing Approach Task; Chalk, C. R., October 1964; Chalk, Charles R.; October 1964
FTC-TR-66-24	Frequency Response Method of Determining Aircraft Longitudinal Short Period Stability and Control System Characteristics in Flight; Klung, H A., Jr.; August 1966
FTC-TR-67-19	Evaluation of Longitudinal Control Feel System Modifications Proposed for USAF F/RF-4 Aircraft ; Keith, L. A., R. R. Richard, and G J. Marrett, December 1968
FTC-TD-72-1	Development and Evaluation of the TWeaD II Flight Control Augmentation System; Carleton, David L., Richard E. Lawyer, and Cecil W. Powell; November 1972
FTC-TD-73-2	Background Information and User Guide for MIL-S-83691; Sharp, Patrick S. and Collet E. McElroy, March 1974
FTC-TR-73-32	Air Force Evaluation of the Fly-by-Wire Portion of the Survivable Flight Control System Advanced Development Program; Majoros, Robert L.; August 1973
FTC-TIH-79-2	USAF Test Pilot School, Flying Qualities Handbook, Flying Qualities Theory and Flight Test Techniques; November 1979
USAFTPS Report 82B-4	Limited Comparison of Longitudinal Flying qualities Between the SAFTD Ground Simulator and the NT-33A In-flight Simulator; Payne, James M., et al; 31 May 1983
USAFTPS-TR-88A-TM1	Adaptable Target Lighting Array System (HAVE ATLAS); Wilson, E. M., et al; Dec 1988
USNTPS-FTM-103	Fixed Wing Stability and Control, Theory and Flight Techniques; 1 November 1981
WL-TR-92-3027	Lessons Learned from the STOL and Maneuver Technology Demonstrator; Moorhouse, David J.; Jun 1993

MIL-STD-1797A
APPENDIX A

WL-TR-93-3081	Aircraft Maneuvers for the Evaluation of Flying Qualities and Agility, Vol 1: Maneuver Development Process and Initial Maneuver Set; Wilson, David J., David R. Riley, and Kevin D. Citurs; McDonnell Douglas Aerospace; Aug 1993
WL-TR-93-3082	Aircraft Maneuvers for the Evaluation of Flying Qualities and Agility, Vol 2: Maneuver Descriptions and Selection Guide; Wilson, David J., David R. Riley, and Kevin D. Citurs; McDonnell Douglas Aerospace; Aug 1993
WL-TR-93-3083	Aircraft Maneuvers for the Evaluation of Flying Qualities and Agility, Vol 3: Simulation Data; Wilson, David J., David R. Riley, and Kevin D. Citurs; McDonnell Douglas Aerospace; Aug 1993
WRDC-TR-89-3036	Results of a Piloted Simulation of the STOL/Maneuver Technology Demonstrator; McDonnell Douglas Aerospace; Aug 1993
4950-FTR-93-05	Closed Loop Handling Tasks Testing and Verification for Class III-L Aircraft; DeWitt, Bruce R.; Oct 1993
FAA FAR Part 23	Airworthiness Standards: Normal, Utility, and Acrobatic Category Airplanes; June 1974
FAA FAR Part 25	Airworthiness Standards: Transport Category Airplanes; June 1974
FAA-ADS-69-13	An In-Flight Investigation of Lateral-Directional Dynamics for Cruising Flight; Hall, G. W.; December 1969
FAA-RD-70-61	A Flight Simulator Study of STOL Transport Lateral Control Characteristics; Drake, Douglas E., Robert A. Berg, Gary L. Teper, and W. Allen Shirley; September 1970
FAA-RD-70-65	Flying Qualities of Small General Aviation Airplanes. Part 2: The Influence of Roll Control Sensitivity Roll Damping, Dutch-Roll Excitation, and Spiral Stability; Ellis, David R.; April 1970
FAA-RD-74-206	Wind Models for Flight Simulator Certification of Landing and Approach Guidance and Control Systems; Barr, Neal M., Dagfinn Gangsaas, and Dwight R. Schaeffer; December 1974
FAA-RD-75-123	Identification of Minimum Acceptable Characteristics for Manual STOL Flight Path Control; Hoh, Roger H., Samuel J. Craig, and Irving L. Ashkenas; June 1976
FAA-RD-77-25	A Study of Lightplane Stall Avoidance and Suppression; Ellis, David R.; February 1977
FAA-RD-77-36	Wind Shear Modeling for Aircraft Hazard Definition; Frost, Walter and Dennis W. Camp; March 1977
FAA-RD-77-173	Proceedings of the First Annual Meteorological and Environmental Inputs to Aviation Systems Workshop. "Wind Models for Flight Simulator Certification of Landing and Approach Guidance and Control Systems", Schaeffer, Dwight R.; March 1977

MIL-STD-1797A
APPENDIX A

FAA-RD-78-7	Simulation and Analysis of Wind Shear Hazard; Lehman, John Ni Robert K. Heffley, and Warren F. Clement; December 1977
FAA-RD-79-59	Powered-Lift Aircraft Handling Qualities in the Presence of Naturally-Occurring and Computer-Generated Atmospheric Disturbances; Jewell, Wayne F., Warren F. Clement, Thomas C. West, and S. R. Ni Sinclair; May 1979
FAA-RD-79-84	Piloted Flight Simulation Study of Low-Level Wind Shear, Phase 4; Foy, W. H. and W. B. Gartner; March 1979
FAA Advisory Circular AC25.253-1A	High-Speed Characteristics; 24 November 1965
DOT/FAA/CT-82/130-II	Flying Qualities of Relaxed Static Stability Aircraft, Vol II; McRuer, D. T and T. T. Myers; September 1982
NACA Memo Rpt L6E20	Flight Investigation to Improve the Dynamic Longitudinal Stability and Control-Feel Characteristics of the P-63A-1 Airplane with Closely Balanced Experimental Elevators, Johnson, Harold I.; July 1946
NASA Memo 1-29-59A	A Pilot Opinion Study of Lateral Control Requirements for Fighter- Type Aircraft; Creer, Brent Y., John D. Stewart, Robert B. Merrick, and Fred J. Drinkwater III; March 1959
NASA Memo 12-10-58A	A Flight Investigation to Determine the Lateral Oscillatory Damping Acceptable for an Airplane in the Landing Approach; McNeill, Walter E. and Richard F. Vomasse-, February 1959
NASA-CP-2028	Proceedings of the First Annual Meteorological and Environmental Inputs to Aviation Systems Workshop, "Wind Models for Flight Simulator Certification of Landing and Approach Guidance and Control Systems"; Schaeffer, Dwight R.; March 1977
NASA-CP-2428	Twenty-First Annual Conference on Manual Control; "A Flight Test Method for Pilot/Aircraft Analysis;" Koehler, Ruthard and Ernst Buchacker; DFVLR; May 1986
NASA-CR-239	Development of Satisfactory Lateral-Directional Handling Qualities in the Landing Approach; Stapieford, Robert L., Donald E. Johnston, Gary L. Teper, and David H. Weir; July 1965
NASA-CR-635	In-Flight and Ground Based Simulation of Handling Qualities of Very Large Airplanes in Landing Approach; Condit, Philip M., Laddie G. Kimbrel, and Robert G. Root; October 1966
NASA-CR-778	Evaluation of Lateral-Directional Handling Qualities of Piloted Re-Entry-Vehicles Utilizing Fixed-Base and In-Flight Evaluations; Meeker, J I May 1967
NASA-CR-2017	Handling Qualities Criteria for the Space Shuttle Orbiter During the Terminal Phase of Flight; Stapleford, Robert L., Richard H. Klein, and Roger H. Hoh; April 1972

MIL-STD-1797A
APPENDIX A

NASA-CR-2451	Non-Gaussian Atmospheric Turbulence Model for Use in Flight Simulators; Reeves, P. M., G. S. Campbell, V. M. Ganzer, and R. G. Joppa; September 1974
NASA-CR-2677	Manual and Automatic Flight Control During Severe Turbulence Penetration; Johnston, Donald E., Richard H. Klein, and Roger H. Hoh, April 1976
NASA-CR-152064	Investigation of the Vulnerability of Powered Lift STOLs to Wind Shear; Hoh, Roger H. and Wayne F. Jewell; October 1976
NASA-CR-152139	Study of a Safety Margin System for Powered-Lift STOL Aircraft; Heffley, Robert K. and Wayne F. Jewell; May 1978
NASA-CR-152194	A Study of Key Features of the RAE Atmospheric Turbulence Model; Jewell, Wayne F. and Robert K. Heffley; October 1978
NASA-CR-159059	An Investigation of Low-Speed Lateral Acceleration Characteristics of Supersonic Cruise Transports Using the Total In-Flight Simulator (TIFS), Weingarten, N. C.; July 1979
NASA-CR-159236	Calspan Recommendations for SCR Flying Qualities Design Criteria-, Chalk, C. R.; April 1980
NASA-CR-163108	Analyses of Shuttle Orbiter Approach and Landing Conditions; Teper, Gary L., Richard J. DiMarco, Irving L. Ashkenas, and Roger H. Hoh; July 1981
NASA-CR-172491	Pitch Rate Flight Control Systems in the Flared Landing Task and Design Criteria Development; Berthe, C. J., C. R. Chalk, and S. Sarrafian
NASA-CR-177331	Mission-Oriented Requirements for Updating MIL-H-8501, Vols. I and II; Clement, W. F., et al.; January 1985
NASA-CR-178188	Flared Landing Approach Flying Qualities; Weingarten, Norman C., et al; Dec 1986
NASA-TM-86728	Application of Frequency Domain Handling Qualities Criteria to the Longitudinal Landing Task; Sarrafian, S. K. and B. G. Powers; August 1985
NASA-TM-101700	Initial Flight Test of a Ground Deployed System for Flying Qualities Assessment; Shafer, M. F., et al; Aug 1989
NASA-TM-X-62	Motion Simulator Study of Longitudinal Stability Requirements for Large Delta Wing Transport Airplanes During Approach and Landing with Stability Augmentation Systems Failed; Snyder, C. T., E. B. Fry, et al., December 1972
NASA-TM-X-1584	A Review of Transport Handling-Qualities Criteria in Terms of Preliminary, XB-70 Flight Experience; Powers, Bruce G.; May 1968
NASA-TN-D-173	Flight Investigation of Automatic Stabilization of an Airplane Having Static Longitudinal Instability; Russell, Walter R., S. A. Sjoberg, and William L. Alford; December 1959

MIL-STD-1797A
APPENDIX A

NASA-TN-D-211	Flight Investigation of Pilot's Ability to Control an Airplane Having Positive and Negative Static Longitudinal Stability Coupled with Various Effective Lift-Curve Slopes; Brissenden, Roy F., William L Alford, and Donald L. Mallick; February 1960
NASA-TN-D-746	Flight Controllability Limits and Related Human Transfer Functions as Determined from Simulator and Flight Tests, Taylor, Lawrence W. and Richard E. Day; May 1961
NASA-TN-D-779	Flight Investigation Using Variable-Stability Airplanes of Minimum Stability, Requirements for High-Speed, High-Altitude Vehicles; McFadden, Norman M., Richard F. Vomaske, and Donovan R Heinle; April 1961
NASA-TN-D-792	Attitude Control Requirements for Hovering Control Through the Use of a Piloted Flight Simulator; Faye, A. E., Jr.; April 1961
NASA-TN-D-1141	The Effect of Lateral-Directional Control Coupling on Pilot Control of an Airplane as Determined in Flight and in a Fixed-Base Flight Simulator; Vomaske, Richard F., Melvin Sadoff, and Fred J. Drinkwater III; November 1961
NASA-TN-D-1328	A Flight Determination of the Attitude Control Power and Damping Requirements for a Visual Hovering Task in the Variable Stability and Control X-14A Research Vehicle; Rolls, L. S. and F. J. Drinkwater; May 1962
NASA-TN-D-1552	A Study of a Pilot's Ability to Control During Simulated Augmentation System Failures; Sadoff, Melvin; November 1962
NASA-TN-D-1888	A Preliminary Study of Handling-Qualities Requirements of Supersonic Transports in High-Speed Cruising Flight Using Piloted Simulators; White, Maurice D., Richard F. Vomaske, Walter E. McNeill, and George E Cooper; May 1963
NASA-TN-D-2251	A Piloted Simulator Study of Longitudinal Handling Qualities of Supersonic Transport in the Landing Maneuver; Bray, Richard S., April 1964
NASA-TN-D-3726	An Evaluation of the Handling Qualities of Seven General-Aviation Aircraft; Barber, Marvin R., Charles K. Jones, Thomas R. Sisk, and Fred W. Haise; November 1966
NASA-TN-D-3910	A Simulator and Flight Study of Yaw Coupling in Turning Maneuvers of Large Transport Aircraft; McNeill, W. E. and R. C. Innis; May 1967
NASA-TN-D-3971	Determination of Flight Characteristics of Supersonic Transports During the Landing Approach with a Large Jet Transport In-Flight Simulator; June 1967
NASA-TN-D-5153	The Use of Pilot Rating in the Evaluation of Aircraft Handling Qualities; Cooper, G. E. and Harper, R. P., Jr.; April 1969

MIL-STD-1797A
APPENDIX A

NASA-TN-D-5466	Simulator Study of Coupled Roll-Spiral Mode Effects on Lateral-Directional Handling Qualities; Grantham, W. D., F. L. Moore, P. L. Deal, and J. M. Patton, Jr.; March 1970
NASA-TN-D-5957	Flight Investigation of the Roll Requirements for Transport Airplanes in Cruising Flight; Holleman, Euclid C.; September 1970
NASA-TN-D-6496	Analysis of a Coupled Roll-Spiral-Mode, Pilot-Induced Oscillation Experienced with the M2-F2 Lifting Body; Kempel, R. W.; September 1971
NASA-TN-D-6811	In-Flight Pilot Evaluations of the Flying Qualities of a Four-Engine Jet Transport; Holleman, Euclid C. and Glenn B. Gilyard; May 1972
NASA-TN-D-7703	Flight Investigation of Advanced Control Systems and Displays for a General Aviation Airplane; Loschke, Paul C., Marvin R. Barber, Einar K Enevoldson, and Thomas C. McMurtry; June 1974
NASA-TP-1368	Flight Comparison of the Transonic Agility of the F-111A Airplane and the F-111 Supercritical Wing Airplane; Friend, Edward L. and Glenn M. Sakamoto; December 1978
NASA-TR-R-199	Dynamic Response of Airplanes to Atmospheric Turbulence Including Flight Data on Input and Response; Houbolt, John C., Roy Steiner, and Kermit G. Pratt; June 1964
NADC-ED-6282	Proposal for a Revised Military Specification, 'Flying Qualities of Piloted Airplanes' (MIL-F-8785ASG) with Substantiating Text; Mazza, C. J., William Becker, et al.; 22 July 1963
NADC-76154-30	"Design Charts and Boundaries for Identifying Departure Resistant Fighter Configurations;" Bihrie, W., Jr. and Barnhart, B.; July 1978
NADC-77052-30	Development of VTOL Flying Qualities Criteria for Low Speed and Hover; Hoh, Roger H. and Irving L. Ashkenas; December 1979
NADC-78182-60	Development and Analysis of a CVA and a 1052 Class Fast Frigate Air Wake Model; Nave, Ronald L.; September 1978
NADC-81186-60	The Control Anticipation Parameter for Augmented Aircraft, Bisclioff, D E.; May 1981
NADC-85091-60	"Investigation of Departure Susceptibility Criteria Using the Dynamic Flight Simulator;" Rhodeside, G.; June 1985
NADC-85130-60	Guidelines for Designing Flying qualities Experiments; Dukes, Theodor A.; Jun 1985
20.4 Nongovernment documents	
AIAA Paper 64-353	Jet Transport Operation in Turbulence; Soderlind, Paul A.; July 1964
AIAA Paper 69-898	Summary and Interpretation of Recent Longitudinal Flying Qualities Results; Ashkenas, I. L.; August 1969
AIAA Paper 75-985	In-Flight Simulation-of the Light Weight Fighters; Hall, G. W. and R. P. Harper; August 1975

MIL-STD-1797A
APPENDIX A

AIAA Paper 77-1119	Direct-Force Flight-Path Control--the New Way to Fly; Watson, John H. and Jack D. McAllister; August 1977
AIAA Paper 77-1122	Equivalent System Approaches to Handling Qualities Analysis and Design Problems in Augmented Aircraft; Hodgkinson, J. and W. J. LaManna, 8-10 August 1977
AIAA Paper 77-1145	A Study of Key Features of Random Atmospheric Disturbance Models for the Approach Flight Phase; Heffley, Robert K.; August 1977
AIAA Paper 78-1500	Rolling Tail Design and Behavior as Affected by Actuator Hinge Moment, Ball, J. M.; August 1978
AIAA Paper 79-1783	Initial Results of an Inflight, Simulation of Augmented Dynamics in Fighter Approach and Landing; Hodgkinson, J. and K. A. Johnston; 6-8 August 1979
AIAA Paper 79-1962	Flight Tests of a Microprocessor Control System; Stengel, R F. and G. E. Miller; October 1979
AIAA Paper 80-0703	Review of Nonstationary Gust-Responses of Flight Vehicles, Gaonkar, G. H.; July 1980
AIAA Paper 80-1611-CP	Flight Evaluation of Augmented Fighter Aircraft; Hodgkinson, J. and R. C. Snyder; 11-13 August 1980
AIAA Paper 80-1626-CP	A Summary of an In-Flight Evaluation of Control System Pure Time Delays During Landing Using the F-8 DFBW Airplane; Berry, D. T., B G. Powers, K. J. Szalai, and R. J. Wilson; 11-13 August 1980
AIAA Paper 80-1627-CP	Low Order Equivalent Models of Highly Augmented Aircraft Determined from Flight Data Using Maximum Likelihood Estimation; Shafer, M. F; 11-13 August 1980
AIAA Paper 80-1628-CP	Handling Qualities Criteria for Wing-Level-Turn Maneuvering During an Air to Ground Delivery; Sammonds, R. I. and J. W. Bunnell, Jr.; August 1980
AIAA Paper 80-1633	Identification of Flexible Aircraft from Flight Data; Eulrick, B. J. and E. D. Rynaski; August 1980
AIAA Paper 80-1836	The Turbulent Wind and Its Effect on Flight; Etkin, B.; August 1980
AIAA Paper 81-0302	Atmospheric Disturbance Models and Requirements for the Flying Qualities Military Standard and Handbook; Heffley, R. K., W. F. Jewell, R. H. Hoh, and D. J. Moorhouse; January 1981
AIAA Paper 87-2561	Analysis and Application of Aircraft Departure Prediction Criteria to the AV-8B Harrier II; Tinger, H.L.; August 1987
AIAA Paper 89-3358	Cooper-Harper Pilot Rating Variability; Wilson, David J. and David R. Riley; Aug 1989
AIAA Paper 90-2822	More on Cooper-Harper Pilot Rating Variability; Riley, David R. and David J. Wilson; Aug 1990
AIAA Paper 93-3645	Development of Flying Qualities and Agility Evaluation Maneuvers; Wilson, David J., David R. Riley, Kevin D. Citurs, and Thomas J. Cord; AIAA Atmospheric Flight Mechanics Conference; Monterey CA; 9-11 Aug 1993

MIL-STD-1797A
APPENDIX A

AIAA Paper 93-3816	Initial Results of an In-Flight Investigation of Longitudinal Flying Qualities for Augmented large Transports in Approach and Landing; Rossitto, K., et al; Aug 1993
SAE ARP 842B	Design Objectives for Flying Qualities of Civil Transport Aircraft
Delft Univ of Tech Memo M-304	Non-Gaussian Structure of the Simulated Turbulent Environment in Piloted Flight Simulation; van de Moeskijk, G. A. J.; April 1978
Princeton Univ Rpt 604	A Study of Pilot-Induced Lateral-Directional Instabilities; Caporali, R. L., J. P. Lamers, and J. R. Totten; May 1962
Princeton Univ Rpt 727	Lateral-Directional Flying Qualities for Power Approach; Seckel, E., G. E. Miller, and W. B. Nixon; September 1966
Princeton Univ Rpt 777	Comparative Flight Evaluation of Longitudinal Handling Qualities in Carrier Approach; Eney, J. A.; May 1966
Princeton Univ Rpt 797	Lateral-Directional Flying Qualities for Power Approach: Influence of Dutch Roll Frequency; Seckel, E., J. A. Franklin, and G. E. Miller, September 1967
Stanford Univ SUDAAR No. 489	Wind Modeling and Lateral Aircraft Control for Automatic Landing; Holley, William E. and Arthur E. Bryson; January 1975
ARC R&M No. 917	Preliminary Report on Behavior of Aeroplanes When Flying Inverted with Special Reference to Some Accidents on "A"; O'Gorman, Mervyn, Chairman, Accidents Committee; January 1919
ESDU Item No. 74031	Characteristics of Atmospheric Turbulence Near the Ground. Part II: Single Point Data for Strong Winds (Neutral Atmosphere), October 1974
ESDU Item No. 75001	Characteristics of Atmospheric Turbulence Near the Ground. Part III Variations in Space and Time for Strong Winds (Neutral Atmosphere), July 1975
IAS Paper 60-18	Development of Lateral-Directional Flying Qualities Criteria for Supersonic Vehicles, Based on a Stationary Flight Simulator Study; Crone, R. M. and R. C. A'Harrar; January 1960
ICAS-86-5.3.4	Handling Qualities for Unstable Combat Aircraft; Gibson, J. C.; September 1986
MDC Rpt A5596	Flying Qualities Analysis of an In-Flight Simulation of High Order Control System Effects on Fighter Aircraft Approach and Landing-, Johnston, K. A. and J. Hodgkinson, 22 December 1978
MDC Rpt A6792	Definition of Acceptable Levels of Mismatch for Equivalent Systems of Augmented Aircraft; Wood, J. R. and J. Hodgkinson; 19 December 1980
NLR-TR-79127U	Determination of Low-Speed Longitudinal Maneuvering Criteria for Transport Aircraft with Advanced Flight Control Systems; Mooij, H. A., W. P. Boer, and M. F. C. van Gool; 1979
NLR Memorandum VS-77-024	A Digital Turbulence Model for the NLR Moving - Base Flight Simulator, Part I; Jansen, C. J., August 1977

**MIL-STD-1797A
APPENDIX A**

NLR Memorandum VS-77-025	A Digital Turbulence Model for the NLR Moving - Base Flight Simulator, Part II; Jansen, C. J.; August 1977
Boeing D6-10725	A Simulator and Flight Evaluation of the Longitudinal and Lateral Control Requirements of the C-5A for the Landing Approach Task; Eldridge, W 18 May 1965
Boeing D6-10732 T/N	A Note on Longitudinal Control Response; Higgins, H. C.; June 1965
Calspan Rpt No. 7738-24	NT-33A In-flight Investigation into Flight Control System Rate Limiting; Ohmit, E. E.; Feb 1994
Calspan FRM No. 554	The Ideal Controlled Element for Real Airplanes Is Not K/s; Chalk, C. R.; August 1981
Comell Aero Lab IH-2154-F-1	Flight Evaluation of a Stability Augmentation System for Light Airplanes; Eckhart, F. F., G. W. Hall, and P. A. Martino; November 1966
Cornell Aero Lab TB-574-F-3	A Flight Investigation of Minimum Acceptable Lateral Dynamic Stability, Graham, D. and C. James; 30 April 1950
Cornell Aero Lab TB-574-F-6	A Flight Investigation of Acceptable Roll to Yaw Ratio of the Dutch Roll and Acceptable Spiral Divergence; Bull, G.; February 1952
Cornell Aero Lab TB-1094-F-I	Flight Evaluations of the Effect of Variable Spiral Damping in a JTB-26B Airplane; Rhoads, D. W.; October 1957
Cornell Aero Lab TB-1444-F-I	Handling Qualities Requirements as Influenced by Prior Evaluation Time and Sample Size; Kidd, E. A. and G. Bull; February 1963
Douglas Aircraft Co. LB-25452	Investigation of Pilot-Induced Longitudinal Oscillation in the Douglas Model A4D-2 Airplane; Terrill, W. H., J. G. Wong, and L. R. Springer; 15 May 1959
General Dynamics Rpt FZM-12-2652	9 December 1968
Norair Rpt No. NOR-64-143	Pilot Induced Oscillations: Their Cause and Analysis; Ashkenas, Irving L., Henry R. Jex, and Duane T. McRuer; June 1964
Systems Tech. Inc. TR-124-1	A Systems Analysis of Longitudinal Piloted Control in Carrier Approach, Cromwell, C. J. and I. L. Ashkenas; June 1962
Systems Tech. Inc. TR-137-2	Carrier Landing Analyses; Durand, Tulvio; February 1967
Systems Tech. Inc. TR-189-1	Background Data and Recommended Revisions for MIL-F-8785B(ASG), 'Military Specification -- Flying Qualities of Piloted Airplanes'; Craig, Samuel J. and Irving L. Ashkenas; March 1971
Systems Tech. Inc. TR-190-1	Outsmarting MIL-F-8785B(ASG), the Military Flying Qualities Specification; Stapleford, Robert L., Duane T. McRuer, Roger H. Hoh, et al; August 1971
Systems Tech. Inc. TR-199-1	Analytical Assessment of the F-14 Aircraft Control and Handling Characteristics; Johnston, Donald E. and Samuel J. Craig; February 1972

**MIL-STD-1797A
APPENDIX A**

Systems Tech. Inc. TR-1090-1	Analytical Assessment of the F-18A Flying Qualities During Carrier Approach; Ringland, R. F. and D. E. Johnston; September 1977
Systems Tech. Inc. WP-189-3	Effect of Sideslip on Precise Lateral Tracking; Hoh, R. H. and H. R. Jex; November 1969
Vought Corp Rpt No. 2-55800/8R-3500	Mathematical Models for the Aircraft Operational Environment of DD-963 Class Ships; Fortenbaugh, R. L.; September 1978
AGARD Rpt 122	The Influence of Drag Characteristics on the Choice of Landing Approach Speeds; Lean, D. and R. Eaton; 1957
AGARD Rpt 357	Some Low-Speed Problems of High-Speed Aircraft; Spence, A. and D. Lean, 1961
AGARD Rpt 372	Theory of the Flight of Airplanes in Isotropic Turbulence - Review and Extension; Etkin, B.; April 1961
AGARD Rpt 420	Flight Measurements of the Influence of Speed Stability on the Landing Approach; Staples, K. J.; 1963
AGARD-AR-82	The Effects of Buffeting and Other Transonic Phenomena on Maneuvering Combat Aircraft; Hamilton, B. I. L.; July 1975
AGARD-AR- 134	Technical Evaluation Report on the Flight Mechanics Panel Symposium on Stability and Control; Chalk, C. R.; January 1979
AGARD-CP-17	AGARD Stability and Control Meeting, September 1966 "Flying Qualities Criteria Problems and Some Proposed Solutions," Carlson, John W. and Richard K. Wilson "Pilot-Induced Instability;" A'Harrah, R. C. and R. F. Siewert
AGARD-CP- 119	Stability and Control; "Flight Simulation - A Significant Aid In Aircraft Design;" A'Harrah, R. C.; April 1972
AGARD-CP-199	Stall/Spin Problems in Military Aircraft; June 1976
AGARD-CP-235	Dynamic Stability Parameters; "Aircraft Stability Characteristics at High Angle of Attack;" Kalviste, J.; November 1978
AGARD-CP-249	Piloted Aircraft Environment Simulation Techniques, "Handling Qualities of a Simulated STOL Aircraft in Natural and Computer-Generated Turbulence and Shear;" Sinclair, S. R. M. and T. C. West; October 1978
AGARD-CP-260	Proceedings of AGARD Flight Mechanics Panel Symposium on Stability and Control, September 1978 "Are Today's Specifications Appropriate for Tomorrow's Airplanes?" A'Harrah, R. C., J. Hodgkinson, and W. J. LaManna "Flying Qualities and the Fly-by-Wire Aeroplane;" Gibson, J. C. "L-1011 Active Controls Design Philosophy and Experience;" Urie, David M.
AGARD-CP-319	Combat Aircraft Maneuverability; "The Military Flying Qualities Specification, a Help or a Hindrance to Good Fighter Design?" A'Harrah, Ralph C. and Robert J. Woodcock; December 1981

MIL-STD-1797A
APPENDIX A

AGARD-CP-333	Criteria for Handling Qualities in Military Aircraft; "Simulation for Predicting Flying Qualities;" Reynolds, P. A.; June 1982
AGARD-CP-452	Flight Test Techniques; "GRATE – A New Flight Test Tool for Flying Qualities Evaluation," Koehler, et al; DFVLR; Jul 1989
AGARD-CP-519	Recent Advances in Long Range and Long Endurance Operation of Aircraft; "Aerial Refueling Interoperability from a Receiver Flying Qualities Perspective"
NATO Rpt 408A	Recommendations for V/STOL Handling Qualities; October 1964
NRC of Canada Rpt LTR-FR- 12	A Flight Investigation of Lateral-Directional Handling Qualities of V/STOL Aircraft in Low Speed Maneuvering Flight; Doetsch, K. H., et al ; 15 August 1969
RAE Aero. 2504	Problems of Longitudinal Stability Below Minimum Drag, Speed, and Theory of Stability Under Constraint; Neumark, S.; 1953
RAE Aero. 2688	A Review of Recent Handling Qualities Research, and Its Application to the Handling Problems of Large Aircraft. Part I: Observations on Handling Problems and Their Study. Part II: Lateral-Directional Handling; Bisgood, P. L.; June 1964
RAE TM-FS-46	Developments in the Simulation of Atmospheric Turbulence; Tomlinson, B. N.; September 1975
RAE TR-68140	Control Characteristics of Aircraft Employing Direct Lift Control, Pinsker, W. J. G.; May 1968
RAE TR-71021	Glide Path Stability of an Aircraft Under Speed Constraint, Pinsker, W. J. G.; February 1971
TSS Standard 5	Supersonic Transport Aeroplane Flying Qualities; 22 May 1964

Ad Hoc Committee Report on B-58 Controllability in Flight, Wright Air Development Division, Wright-Patterson AFB, OH, 2 April - 10 May, 1960

Anderson, Ronald O., A Second Analysis of B-58 Flight Control System Reliability, Flight Control Laboratory, Wright-Patterson AFB, OH, 6 November 1962

Ashkenas, I. L. and T. Durand, "Simulator and Analytical Studies of Fundamental Longitudinal Control Problems in Carrier Approach," presented at AIAA Simulation for Aerospace Flight Conference, August. 1963

Behel, I. M. and W. B. McNamara, "F/A-18A High Angle of Attack/Spin Testing," 25th International Report to the Aerospace Profession, Society of Experimental Test Pilots, September, 1981

Bureau of Naval Weapons Failure Rate Data Handbook, prepared by U. S. Naval Ordnance Laboratory; Corona, CA (updated periodically)

Caravello, Christopher, Randal G. Joslin, Giuseppe Fristachi, Charles R. Bisbee, Steven S. Weatherspoon, and Steven G. Henrich, Limited Flight Evaluation as a Function of Aircraft Longitudinal Dynamics, Air Force Test Pilot School, Class 79A Final Report, December, 1979

Curry, R. E. and A. G. Sim, Unique Flight Characteristics of the AD-1 Oblique-Wing Research Airplane, J Aircraft, v. 20, nr. 6, June, 1983

"Development of the F/A-18 Handling Qualities Using Digital Flight Control Technology," Society of Experimental Test Pilots 1982 Report to the Aerospace Profession, 26th Annual Proceedings, September, 1982

MIL-STD-1797A
APPENDIX A

- Dryden, Hugh L., "A Review of the Statistical Theory of Turbulence," Turbulence - Classic Papers on Statistical Theory, New York: Interscience Publishers, Inc., 1961
- Etkin, B., "A Theory of the Response of Airplanes to Random Atmospheric Turbulence," J. Aero/Space Sciences, July, 1959, 409-420
- Etkin, Bernard, Dynamics of Atmospheric Flight, New York: Wiley, 1972
- Etkin, Bernard, Dynamics of Flight, New York: Wiley, 1959
- Finberg, Floyd, Report of the T-38 Flight Control System PIO Review Board. USAF ASD, February, 1963
- Hirsch, Darrell, "Investigation and Elimination of PIO Tendencies in the Northrop T-38A," SAE Paper, Amb, New York, July, 1964
- NW Hodgkinson, J., "Equivalent Systems Approach for Flying Qualities Specification," presented at SAE Aerospace Control and Guidance Systems Committee Meeting, Denver, CO, 7-9 March, 1979
- Hodgkinson, J., R. L. Berger, and R. L. Bear, "Analysis of High Order Aircraft/Flight Control System Dynamics Using an Equivalent System Approach," presented at 7th Annual Pittsburgh Conference on Modeling and Simulation, 26-27 April, 1976
- Hodgkinson, J., W. J. LaManna, and J. L. Heyde, "Handling Qualities of Aircraft with Stability and Control Augmentation Systems - A Fundamental Approach," J. R. Ae. S., February, 1976
- Houbolt, John C., "Atmospheric Turbulence," AIAA J., Vol. II, No. 4, April, 1973, 421-437
- "Industry Observer," Aviation Week and Space Technology, 1 April, 1968, 13
- Jacobson, Ira D. and Dinesh S. Joshi, "Investigation of the Influence of Simulated Turbulence on Handling Qualities," J. Aircraft, Vol.14, No. 3, March 1977, 272-275
- Jones, J. G., "Modelling of Gusts and Wind Shear for Aircraft Assessment and Certification," Royal Aircraft Establishment, Paper prepared for CAARC Symposium on Operational Problems, India, October, 1976
- Lappe, V. Oscar and Ben Davidson, "On the Range of Validity of Taylor's Hypothesis and the Kilmogoroff Spectral Law," J. Atmos. Sciences, Vol. 20, November, 1963
- Lappe, V. Oscar, "Low-Altitude Turbulence Model for Estimating Gust Loads on Aircraft," J Aircraft, Vol. 3, No. 1, Jan - Feb, 1966
- Lumley, John L. and Hans A. Panofsky, The Structure of Atmospheric Turbulence, New York: Interscience Publishers, Inc., 1964
- McRuer, Duane, Irving Ashkenas, and Dunstan Graham, Aircraft Dynamics and Automatic Control, Princeton University Press, 1973
- Mitchell, David G. and Roger H. Hoh, "Low-Order Approaches to High-Order Systems: Problems and Promises," J. Guidance, Control, and Dynamics, Vol. 5, No. 5, Sept - Oct 1982, 482-489
- Morgan, Clifford T., Jesse S. Cook, Alphonse Chapanis, and Max W. Lund, eds., Human Engineering Guide to Equipment Design, New York: McGraw-Hill, 1963
- Morgan, Len, "Out for a Spin," Flying, February, 1982
- Neal, T. Peter, "Influence of Bobweights on Pilot-Induced Oscillations," J. Aircraft, September, 1971
- Otnes, R. K. and L. Enochson; Applied Time Series Analysis, Vol. 1. Basic Techniques; New York- Wiley-Interscience; 1978

MIL-STD-1797A
APPENDIX A

Perkins, Courtland D. and Robert E. Hage, Airplane Performance Stability and Control, New York- Wiley 1949

"Proposals for Revising MIL-F-8785B, 'Flying Qualities of Piloted Airplanes'," AFFDL-FGC Working Paper, February, 1978

Rediess, H. A., D. L. Mallick, and D. T. Berry, Recent Flight Test Results on Minimum Longitudinal Handling Qualities for Transport Aircraft, presented at the FAUST VIII Meeting, Washington, D.C., January 1981

Richards, D. and C. D. Pilcher, "F/A-18A Initial Sea Trials," SETP Cockpit, April/May/June, 1980

Sammonds, R. I., W. E. McNeill, and J. W. Bunnell, "Criteria for Side-Force Control in Air-to-Ground Target Acquisition and Tracking," J. Aircraft, v. 19, nr. 9, September, 1982

Scott, W. B., "Reengined KC-135 Shows Performance Gains in Test," Aviation Week & Space Technology, v. 118, nr. 8, McGraw-Hill, February 21, 1983

Stengel, R. F. and G. E. Miller, "Pilot Opinions of Sampling Effects in Lateral-Directional Control," presented at 16th Annual Conference on Manual Control, Cambridge, MA, May, 1980

Tentative Airworthiness Objectives and Standards for Supersonic Transport Design Proposals, Flight Standards Service, FAA, 15 August, 1963

Van Patten, Robert E., Investigation fo the Effects of g_y and g_z on AFTI/F-16 Control Inputs. Restraints and Tracking Performance, Interim USAF AMRL Technical Report, August, 1981

von Karman, Theodore, "Progress in the Statistical Theory of Turbulence," Turbulence - Classic Papers on Statistical Theory, New York: Interscience Publishers, Inc., 1961

MIL-STD-1797A
APPENDIX A

30. DEFINITIONS

3.1 Aircraft classification and operational missions. For the purpose of this standard, the aircraft specified in this requirement is to accomplish the following missions:_____. The aircraft thus specified will be a Class aircraft. The letter -L following a class designation identifies an aircraft as land-based, carrier-based aircraft are similarly identified by -C. When no such differentiation is made in a requirement, the requirement applies to both land-based and carrier-based aircraft.

REQUIREMENT RATIONALE (3.1)

The very reason for procuring aircraft is to perform one or more missions. The class designation is used in the handbook to help particularize the requirements according to broad categories of intended use.

REQUIREMENT GUIDANCE

The related MIL-F-8785C paragraphs are 1.3, 1.3.1 and 3.1.1.

Missions

The standard needs a specific mission statement to furnish guidance for interpreting qualitative requirements as well as for consistent selection of quantitative requirements. Unfortunately, the word "mission" is used in several contexts not only in this standard, but throughout the writings pertinent to acquiring a new weapon system. In the broadest sense, "operational missions" applies to classifying the aircraft as fighter, bomber, reconnaissance, etc., or to "accomplishing the mission" of bombing, strafing, etc. In 3.1 the object is to introduce to the designer in general terms the function of the vehicle he is to design. It should be sufficient for the procuring activity to refer to those paragraphs of the System Specification and Air Vehicle Specification to define the overall performance requirements, the operational requirements, employment and deployment requirements.

The operational missions considered should not be based on just the design mission profiles. However, such profiles serve as a starting point for determining variations that might normally be expected in service, encompassing ranges of useful load, flight time, combat speed and altitude, in-flight refueling, etc., to define the entire spectrum of intended operational use.

"Operational missions" include training and ferry missions.

The intended use of an aircraft must be known before the required configurations, loadings, and the Operational Flight Envelopes can be defined and the design of the aircraft to meet the requirements of this standard undertaken. If additional missions are foreseen at the time the detail specification is prepared, it is the responsibility of the procuring activity to define the operational requirements to include these missions. Examples of missions or capabilities that have been added later are in-flight refueling (tanker or receiver), aerial pickup and delivery, low-altitude penetration and weapon delivery, and ground attack for an air-superiority fighter or vice versa.

Once the intended uses or operational missions are defined, a Flight Phase analysis of each mission must be conducted. With the Flight Phases established, the configurations and loading states which will exist during each Phase can be defined. After the configuration and loading states have been defined for a given Flight Phase, Service and Permissible Flight Envelopes can be determined and Operational Flight Envelopes more fully defined.

MIL-STD-1797A
APPENDIX A

4.1.6 Aircraft Normal States.

The contractor shall define and tabulate all pertinent items to describe the Aircraft Normal States (no component or system failure) associated with each of the applicable Flight Phases. This tabulation shall be in the format and use the nomenclature of table 11. Certain items, such as weight, moments of inertia, center-of-gravity position, wing sweep, or thrust setting may vary continuously over a range of values during a Flight Phase. The contractor shall replace this continuous variation by a limited number of values of the parameter in question which will be treated as specific States, and which include the most critical values and the extremes encountered during the Flight Phase in question.

REQUIREMENT RATIONALE (4.1.6)

Definition of normal aircraft states is basic to application of the flying qualities requirements.

REQUIREMENT GUIDANCE

The related MIL-F-8785C paragraphs are 3.1.6.1 and 4.2.

It is possible that items not normally considered, such as setting or automatic operation of engine bypass doors, can affect flying qualities.

The contractor is required to define the Aircraft Normal States for each applicable Flight Phase, in the format of table II. If the position of any particular design feature can affect flying qualities independently of the items in table 11, its position should be tabulated as well. Initially, variable parameters should be presented in discrete steps small enough to allow accurate interpolation to find the most critical values or combinations for each requirement; then those critical cases should be added. As discussed under 4.1.1 through 4.1.3, center-of-gravity positions that can be attained only with prohibited, failed, or malfunctioning fuel sequencing need not be considered for Aircraft Normal States.

REQUIREMENT LESSONS LEARNED

5.1.6 Aircraft Normal States-verification.

The contractor shall furnish a list of Aircraft Normal States in accordance with the Contract Data Requirements List.

VERIFICATION RATIONALE (5.1.6)

Definition of normal aircraft states is basic to application of the flying qualities requirements.

VERIFICATION GUIDANCE

Definition of normal aircraft states is basic to application of the flying qualities requirements.

VERIFICATION LESSONS LEARNED

MIL-STD-1797A
APPENDIX A

4.1.6.1 Allowable Levels for Aircraft Normal States.

Flying qualities for Aircraft Normal States within the Operational Flight Envelope shall be Level 1. Flying qualities for Aircraft Normal States within the Service Flight Envelope but outside the Operational Flight Envelope shall be Level 2 or better. To account for the natural degradation of pilot-vehicle performance and workload in intense atmospheric disturbances, the requirements of 4.1.6.1 through 4.1.6.3 are adjusted according to 4.9.1.

4.1.6.2 Flight outside the Service Flight Envelopes.

From all points in the Permissible Flight Envelopes and outside the Service Flight Envelopes, 4 shall be possible readily and safety to return to the Service Flight Envelope without exceptional pilot skill or technique. The requirements on flight at high angle of attack, dive characteristics, dive recovery devices and dangerous flight conditions shall also apply in all pertinent parts of the Permissible Flight Envelopes.

4.1.6.3 Ground operation.

Some requirements pertaining to taxiing, takeoffs, and landing involve operation outside the Operational, Service, and Permissible Flight Envelopes, as at V_S or on the ground. When requirements are stated at conditions such as these, the Levels shall be applied as if the conditions were in the Operational Flight Envelopes.

REQUIREMENT RATIONALE (4.1.6.1 - 4.1.6.3)

Levels of flying qualities as indicated in 3.3 apply generally within the Operational and Service Flight Envelopes. Some basic requirements, generally qualitative in nature, apply in both the Operational and Service Flight Envelopes. Provision must also be made for expected and allowable operation outside these envelopes.

REQUIREMENT GUIDANCE

The related MIL-F-4785C requirements are paragraphs 3.1.10, 3.1.10.1, 3.1.10.3.1, 3.1.10.3.2, 3.1.10.3.3, 3.8.3, and 3.8.3.1.

Aircraft Normal States include both all-up operation and degradations/failures that are sufficiently probable to be considered Normal. See 4.1.7 and 4.1.7.1 for guidance on the latter.

Note that flying qualities which "warrant improvement" according to figure 6 nevertheless meet all the requirements if they only occur outside the Operational Flight Envelope.

Where Levels are not specified, care should be taken in selecting requirements from this handbook that will not overburden the designer. We have tried to keep the impact of 4.1.6.1 in mind in writing the recommended material to fill in the blanks, but qualitative words such as "objectionable" must be taken in the context of relevance to operational use.

Since there are few requirements in Aircraft Failure States outside the Service Flight Envelope, implicit assumptions for 4.1.6.2 are that:

Failures at these conditions are very rare, or
Not-so-rare failures at these conditions are manageable
Given one or more failures within the Service Flight Envelope which would have serious consequences beyond, at a minimum the crew would be warned away from danger
(4.1.8).

Similar assumptions apply for 4.1.6.3. In any given case, their validity will need to be checked.

REQUIREMENT LESSONS LEARNED

5.1.6.1 Allowable Levels for Aircraft Normal States - verification.

Verification shall be by analysis, simulation, and test. Final verification shall be by demonstration in the performance of the following tasks:

MIL-STD-1797A
APPENDIX A

5.1.6.2 Flight outside the Service Flight Envelopes - verification.

Verification shall be by analysis, simulation and test. Final verification shall be by demonstration in the performance of the following tasks:

5.1.6.3 Ground operation - verification.

Verification shall be by analysis, simulation and test. Final verification shall be by demonstration in the performance of the following tasks:

VERIFICATION RATIONALE (5.1.6.1 - 5.1.6.3)

Compliance with quantitative, open-loop (pilot-out-of-the-loop) requirements can be shown by analysis with data derived from flight test. However, compliance with only the quantitative, open-loop requirements does not guarantee that the required Levels of flying qualities have been achieved. The quantitative, open-loop requirements are based on historical data and research experiments with ground-based and in-flight simulators. Obviously, this data base has not evaluated each and every one of the infinite possible combinations of aircraft physical and dynamic characteristics at every possible flight condition in every possible task. The criteria in the quantitative, open-loop requirements are based on interpolation between and extrapolation beyond the configurations, flight conditions, and tasks that have been evaluated in the existing data base. Given the degree of generalization in this standard (all possible aircraft configurations generalized into four Classes, all possible tasks generalized into three Flight Phase Categories, and all possible flight conditions generalized into three Flight Envelopes) a certain amount of discrepancy between Level boundaries and pilot-observed flying qualities is to be expected occasionally. Furthermore, while the most significant factors affecting flying qualities have been identified and Level boundaries established for them, significant factor interactions, which have not been as well identified to date, may also cause discrepancies between Level boundaries and observed flying qualities. Other sources of such discrepancies are pilot and task variabilities. The pilots used to evaluate a configuration in a flight test program or a research experiment, and the levels of task performance required for desired and adequate ratings, will certainly skew the results. Therefore, in order to insure that the aircraft has achieved the required Levels of flying qualities, the aircraft must be evaluated by pilots in high-gain, closed-loop tasks. (In the context of this document, high-gain task means a wide-bandwidth task, and closed-loop means pilot-in-the-loop.) For the most part, these tasks must be performed in actual flight. However, for conditions which are considered too dangerous to attempt in actual flight (i.e., certain flight conditions outside of the Service Flight Envelope, flight in severe atmospheric disturbances, flight with certain Failure States and Special Failure States, etc.), the closed-loop evaluation tasks can be performed on a simulator.

During the requirements definition process, the procuring agency, together with the contractor(s) and the responsible test organization, should select several closed-loop tasks with which to evaluate the aircraft in flight test. During system development, ground-based and in-flight simulations should be used to get an initial appraisal of how well the aircraft will perform the tasks in flight. The simulations can also be used to train the test pilots and refine the tasks, performance objectives, and test procedures. Handling qualities evaluation during flight test should consist of four parts: 1) "open-loop" tasks such as steps, doublets, and frequency sweeps for parameter identification to compare aircraft dynamic response to the open-loop requirements, 2) capture tasks to familiarize the pilot with aircraft response and capture characteristics, 3) Handling Qualities During Tracking (HQDT) for initial closed-loop handling qualities evaluation, and 4) "operational" closed-loop tasks to obtain Cooper-Harper ratings. The distinction between HQDT and "operational" tasks is discussed in 5.1.11.6 Verification Guidance.

VERIFICATION GUIDANCE

A wide variety of closed-loop tasks have been developed for the evaluation of aircraft flying qualities. Recommended tasks for the evaluation of flying qualities for Flight Phase Category A include air-to-air and air-to-ground tracking, particularly the well-defined set of tasks known as HQDT, aerial refueling, close formation flying, and captures. Recommended tasks for the evaluation of flying qualities for Flight Phase Category C are tracking tasks, including HQDT, close formation flying, precision landings (with and without vertical and lateral offsets), takeoffs, and captures. More detailed discussions of each of these recommended tasks will be found in subsequent paragraphs of this section and 5.1.11.6 Verification Guidance. Other tasks which are critical to the mission that the aircraft is intended for may also be used as evaluation tasks, such as terrain-following, weapons delivery, or LAPES.

MIL-STD-1797A
APPENDIX A

There are no recommended tasks for Flight Phase Category 8 because this Flight Phase Category generally consists of low-gain (low-bandwidth) tasks. Possible flying qualities problem in this Flight Phase Category will normally be exposed in the more demanding tasks for Flight Phase Categories A and C, and by normal operations during the flight test program. Thus, special tasks for this Flight Phase Category are not normally considered necessary. However, Flight Phase Category B tasks are normally of much longer duration than the tasks in the other Categories. Pilot fatigue may become a significant factor in certain mission critical Category B tasks, in which case an evaluation of this kind of task might be required.

Proof of compliance in these demonstration tasks will consist of pilot comments and Cooper-Harper (C-H) ratings. For Level 1, pilot comments must indicate satisfaction with aircraft flying qualities, with no worse than "mildly unpleasant" deficiencies, and median C-H ratings must be no worse than 3.5 in calm air or in light atmospheric disturbances. For Level 2, pilot comments must indicate that whatever deficiencies may exist, aircraft flying qualities are still acceptable, and median C-H ratings must be no worse than 6.5 in calm air or light atmospheric disturbances. For Level 3, pilot comments must indicate that the aircraft is at least controllable despite any flying qualities deficiencies, and median C-H ratings must be no worse than 9.5 in calm air or light atmospheric disturbances. In moderate to severe atmospheric disturbances pilot comments and C-H ratings must comply with the requirements of 4.9.1.

Actual task performance is not recommended for use as proof of compliance because it is even more subject to pilot variability than pilot comments and C-H ratings. The performance objectives suggested in the tasks described below are not intended for use as proof of compliance, but, rather, for use with the C-H scale. Specific definitions of desired and adequate performance objectives reduce pilot variability by insuring that all of the evaluation pilots attempt to achieve the same level of performance. In the performance objectives suggested below, adequate performance is set at a level sufficient to successfully perform similar tasks in operational service. Desired performance is set at a more demanding level to insure that system deficiencies are exposed. Although task performance is not recommended as proof of compliance, task performance should be recorded and analyzed by the flight test engineers to insure that pilot ratings are reasonably consistent with the level of performance achieved and that all pilots seem to be attempting to achieve the same level of performance.

The evaluation of aircraft flying qualities is basically a subjective science, and human variability makes analysis of the results a difficult proposition. Nevertheless, there are steps that can be taken to reduce variability in the results and insure a good evaluation. First of all, it is absolutely necessary that more than one evaluation be made for each test condition. Studies of inter-pilot C-H rating variability have indicated that three pilots is the minimum number of pilots for an adequate evaluation (CAL Report No. TB-1444-F-1 and NADC-85130-60). More pilots will increase confidence in the results, but NADC-85130-460 further demonstrated that the point of diminishing returns was reached at about six. Therefore, the recommended number of pilots per test condition is three to six. Careful selection of the evaluation pilots will also reduce the variability in results. All of the evaluation pilots must be test pilots trained in the use of the C-H scale and they all must be experienced in the Class of aircraft under evaluation. Furthermore, for acquisition purposes, it is highly desirable that at least half of the evaluation pilots be military-employed test pilots. (Use of operational pilots to evaluate the aircraft during the development effort can often provide additional insights into the handling qualities. Such evaluations are strongly encouraged. However, for the purpose of demonstrating compliance with this requirement, the evaluation pilots should be trained test pilots.)

In order to insure that all of the pilots attempt to achieve the same level of performance, and thus insure consistency and reduce the effects of pilot variability, it is extremely important to explicitly define the desired and adequate levels of task performance to be used for the C-H ratings. Best results are achieved with task performance defined in terms of quantifiable objectives which the pilot can readily observe himself in real time. Furthermore, consideration must be given to defining objectives that can also be recorded on some medium so that the flight test engineer can confirm that pilot ratings are reasonably consistent with task performance. Defining quantifiable and recordable task performance objectives and setting appropriate levels of desired and adequate performance is the most difficult part of planning the flying qualities evaluation. Guidance on task objectives for each of the recommended tasks is given in subsequent paragraphs in this section and lessons learned from past experience are provided in Verification Lessons Learned.

MIL-STD-1797A
APPENDIX A

Another method to reduce the effects of variability is to use the "long-look" evaluation technique. In this technique the pilot continues or repeats the task until he is confident of his evaluation before he assigns a C-H rating. (As opposed to doing it once and assigning a rating.) The "long-look" approach allows the pilot a more extensive appraisal of the test condition. It allows him to weed out the effects of unique events in a single run. It allows him to get over the learning curve, and it allows him to clear his memory of characteristics he may have observed in evaluation of a preceding condition. Although the C-H rating is given only after multiple runs, pilot comments must be provided during and after each run. In order to insure that variability is not introduced by pilots doing different numbers of repeat runs, the recommended procedure is to specify a minimum number of runs to be performed before a rating can be given, and allow the pilot to make additional runs if he feels it is necessary.

Pilot comments should be considered the most important data. A C-H rating is only a summary of observed flying qualities characteristics into a single number. Pilot comments identify the specific deficiencies, if any, that must be corrected. Furthermore, the "long-look" technique filters the effects of deficiencies on the C-H rating because, over several runs, the pilot learns to compensate for some deficiencies. Since pilot comments are given for every run, the comments will identify all observed deficiencies, even those which can be compensated for. Comments on succeeding runs provide guidance on the pilot's ability to compensate for the deficiencies and the final C-H rating indicates the relative significance of these deficiencies. Therefore, pilot comments must be recorded and analyzed for every test run.

Time and cost constraints prohibit piloted evaluation of every task in every possible aircraft configuration at every possible point in the flight envelope. The conditions that must be evaluated are the most common operating conditions, operating conditions critical to the mission of the aircraft, and the worst case conditions, especially those where the quantitative, open-loop flying qualities requirements are violated by wide margins. For aircraft with multiple flight control modes, all mode transitions should be evaluated at common, mission critical, and worst case conditions, especially mode switches which are done automatically, as opposed to those deliberately switched by the pilot. Furthermore, the degradation due to atmospheric disturbances should be demonstrated by evaluation at different levels of disturbances. Evaluation of the effect of severe atmospheric disturbances may be performed in ground simulation. When using simulation to predict the degradation of flying qualities due to severe atmospheric disturbances, it will be necessary to correlate C-H ratings gathered from simulation sessions in light to moderate turbulence with C-H ratings obtained from flight test in light to moderate turbulence for the same task.

The following paragraphs discuss some recommended tasks and some suggested performance objectives for each task. BEAR IN MIND THAT THE PERFORMANCE OBJECTIVES ARE NOT REQUIRED AS PROOF OF COMPLIANCE. THEY ARE INTENDED FOR USE WITH THE COOPER-HARPER SCALE TO REDUCE PILOT VARIABILITY. Most of these tasks are equally suitable for both the "operational" technique and the HQDT technique (see 5.1.11.6 Verification Guidance). The following list of tasks is not exclusive. Any closed-loop task, performed aggressively, may be used to evaluate an aircraft's handling qualities and PIO characteristics. When developing a specification for a particular program, the procuring agency should discuss possible tasks and performance objectives with other procuring agencies, Wright Laboratory, AFFTC, and potential contractors.

Capture Tasks

Capture tasks are intended to evaluate handling qualities for gross acquisition as opposed to continuous tracking. A wide variety of captures can be done provided that the necessary cues are available to the pilot. Pitch attitude, bank angle, heading, flight path angle. Angle-of-attack, and g captures have all been done in previous programs to evaluate different aspects of the aircraft response. These capture tasks are done almost precognitively by the pilot and are usually over so quickly that they do not lend themselves well to use with the Cooper-Harper scale. It can be done, of course, but it is not necessary. Qualitative comments are sufficient proof of compliance for these tasks.

These capture tasks can give the pilot a general impression of the handling qualities of the aircraft, but because they do not involve closed-loop tracking they do not expose all of the problems that arise in continuous control tasks. Capture tasks should not be used as the only

MIL-STD-1797A
APPENDIX A

evaluation tasks. As a minimum an off set precision landing task and some form of tracking task should also be used. Capture tasks are

MIL-STD-1797A
APPENDIX A

ideal as a pre-test before performing high-gain, closed-loop tasks because they serve to familiarize the pilot With the aircraft response before attempting the more difficult (and sometimes more dangerous) high-gain, closed-loop tasks. If hazardous motions result from the capture tasks at any flight condition, closed-loop tasks should not be attempted at that flight condition, and the aircraft should be considered to have failed this requirement at that condition. For pitch captures, the aircraft is trimmed about a specified flight condition. The pilot aggressively captures 5° pitch attitude (or 10° if the aircraft is already trimmed above 5°). He then makes a series of aggressive pitch captures of 5° increments in both directions. He then continues this procedure with 10° increments in both directions, and then with 15° increments in both directions. Aircraft with more capability can continue the procedure with larger pitch excursions. It possible, the initial conditions for each maneuver should be such that the aircraft will remain within ± 1000 feet and ± 10 knots of the specified flight condition during the maneuver, however, large angle captures at high-speed conditions will inevitably produce larger speed and altitude changes. If the aircraft should get too far from the specified condition during a task, it should be retrimmed about the specified condition before starting the next maneuver.

The other kinds of captures are usually done in a similar manner, with some minor differences. G captures are usually done from a constant-g turn and the increments are usually ± 1 g, ± 2 g, and ± 3 g. and larger increments if the aircraft has greater capability. Heading captures can be used to evaluate the yaw controller alone (usually small heading changes of 5° or less) or to evaluate coordination of yaw and roll controllers (larger heading changes).

Bank angle captures are also commonly done using bank-to-bank rolls. Starting from a 150 bank angle, the pilot aggressively rolls and captures the opposite 15° bank angle (total bank angle change of 30°). He then rolls back and captures 150 bank in the original direction. This procedure should continue for a few cycles. The procedure is then repeated using 30° bank angles, and then repeated again using 45° bank angles. Aircraft with more capability can continue the procedure with larger bank angles. A variation of this is to capture wings-level from the initial banked condition. Four-point and eight-point rolls, standard aerobatics maneuvers, are also good tests of roll control.

Air-to-Air Tracking

The air-to-air tracking task consists of two phases: gross acquisition and fine tracking. Gross acquisition evaluates the ability to point and capture with mode rate-amplitude inputs. Fine tracking evaluates continuous closed-loop controllability. Two different kinds of targets have been used successfully in handling qualities evaluations: a real target aircraft and a target generated by a HUD (Head-Up Display).

If a real target is used, there are several possible target maneuvers which have been used in handling qualities evaluations in the past. In all cases the target aircraft begins the maneuver from straight and level flight in front of the evaluation aircraft at a specific flight condition. Throughout the maneuver the evaluation aircraft should remain within ± 1000 feet of the test altitude and within ± 50 knots of the test airspeed.

The maneuver most commonly used is an S-turn. The target aircraft initiates a level turn at a specified load factor. After a specified time period the target unloads, reverses, and begins a level turn in the opposite direction at the specified load factor. After a specified time period, the maneuver is terminated.

For gross acquisition, the evaluation pilot should allow the target aircraft to achieve a certain amount of angular displacement before he initiates his maneuver to acquire the target. Some programs have stated the angular displacement explicitly (for example, 100 mils or 30°). Other programs have used the point at which the target crosses the canopy bow to initiate gross acquisition. Yet another option is to allow a specified amount of time between the target aircraft turn and the evaluation aircraft turn (3-4 seconds). Commonly used performance objectives for gross acquisition are time to acquire, the number of overshoots, and the size of the overshoots. Acquisition is defined as bringing the pipper (or whatever the pilot is using to track with) within a certain radius of some specified point on the target (tail pipe, fuselage/wing junction, canopy, etc.). Time to acquire is the time it takes to bring the pipper within this radius and keep it there.

MIL-STD-1797A
APPENDIX A

Time to acquire is a difficult objective to recommend specific values for in a general standard because it is not only a function of handling qualities, but also a function of handling

MIL-STD-1797A APPENDIX A

of the size of the initial angular displacement between piper and target point and of the maximum pitch rate performance of the aircraft under evaluation. Programs must consider both of these when determining what time to acquire to specify. An overshoot is when the piper moves past the target point by some amount of angular displacement. Some suggested performance objectives are given in table LVIII.

An illustration of overshoot is shown in the sketch below, which shows the time histories of three theoretical gross acquisitions. Assume the desired criteria are: no more than one overshoot greater than 5 mils and no overshoots greater than 10 mils. The thick continuous line would fail this criteria because it has one overshoot greater than 10 mils (at about 0.5 seconds). The thin continuous line also fails this criteria because it has two overshoots greater than 5 mils (around 0.5 seconds and 0.9 seconds). The dashed line meets this criteria because it has only one overshoot that exceeds 5 mils but that overshoot is less than 10 mils.

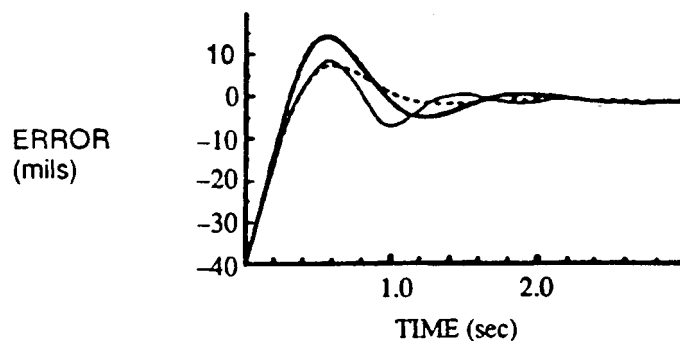

For fine tracking, the time between reversals should allow for time to acquire plus time for extended tracking. A minimum of at least 20 seconds between reversals is recommended. The nominal range between the target aircraft and the evaluation aircraft should be about 1500 feet, with excursions of no more than ± 500 feet from nominal. The performance objective for fine tracking is to keep the piper within a certain radius of the target point for a large percentage of the tracking time. Some suggested performance objectives are given in table LVIII.

For the long-look technique, this maneuver should be repeated a few times before giving a C-H rating. On a ground-based simulator the sequence of turns can continue uninterrupted until the evaluation pilot is confident that he has a good evaluation of the aircraft. This evaluation should be conducted at different airspeeds, different altitudes, and with different load factors throughout the Operational and Service Flight Envelopes.

Another common target maneuver is the wind-up turn. In the wind-up turn, the target aircraft begins a turn and slowly and smoothly increases the load factor to a specified maximum load factor. The target aircraft should attempt to maintain a specified rate of g increase, about .2 g/sec is recommended. The maneuver is terminated shortly after the maximum load factor is reached. Gross acquisition in this maneuver is similar to that for the S-turns. For fine tracking, the rate of g increase should allow sufficient time for gross acquisition and extended tracking time. For the long-look technique this maneuver should be repeated a few times. This evaluation maneuver should be initiated from various altitudes and airspeeds throughout the Operational and Service Flight Envelopes.

Other target-tracking maneuvers that have been used in the past are discussed in Verification Lessons Learned.

**MIL-STD-1797A
APPENDIX A**

TABLE LVIII. Suggested performance objectives for various evaluation tasks.

Suggested Tasks	Suggested Performance Objectives
Air-to-Air and Air-to-Ground Tracking: Gross Acquisition	Desired Performance Time to acquire: TBD Overshoots: no more than one greater than 5 mils. none to exceed 10 mils No PIO
	Adequate Performance Time to acquire: TBD Overshoots: no more than two greater than 5 mils, none to exceed 20 mils
Air-to-Air and Air-to-Ground Tracking: Fine Tracking	Desired Performance Keep the pipper within 5 mils of the target point for three continuous seconds No PIO
	Adequate Performance Keep the pipper within 10 mils of the target point for three continuous seconds
Close Formation	Desired Performance Excursions no greater than ± 2 feet from the formation position No PIO
	Adequate Performance Excursions no greater than ± 4 feet from the formation position
Aerial Refueling: Boom Tracking	Desired Performance Keep pipper within 5 mils of the boom nozzle for at least 50% of the tracking time No PIO
	Adequate Performance Keep pipper within 10 mils of the boom nozzle for at least 50% of the tracking time
Aerial Refueling: Probe-and-drogue	Desired Performance Hook-up without touching basket webbing in at least 50% of the attempts No PIO
	Adequate Performance Hook-up in at least 50% of attempts

MIL-STD-1797A
APPENDIX A

Offset Precision Landing: Approach	Desired Performance Flightpath control: Remain within ± 1 degree of glideslope angle or $\pm \frac{1}{2}$ dot on ILS Airspeed control: Maximum of 5 knots above approach speed, minimum TBD No PIO
	Adequate Performance Flightpath control: Remain within ± 2 degrees of glideslope angle or ± 1 dot on ILS Airspeed control: Maximum of 10 knots above approach speed, minimum TBD, but not less than V_{stall}

**MIL-STD-1797A
APPENDIX A**

TABLE LVIII. Suggested performance objectives for various evaluation tasks - Cont'd.

Suggested Tasks	Suggested Performance Objectives
Offset Precision Landing: Touchdown (Conventional aircraft)	Desired Performance Touchdown zone: within ± 25 feet of aimpoint laterally, within -100 to +400 feet of aimpoint longitudinally Speed at touchdown: maximum of 5 knots above landing speed, minimum TBD Attitude at touchdown: TBD Sink rate at touchdown: TBD No PIO
	Adequate Performance Touchdown zone: within ± 50 feet of aimpoint laterally, within -250 to +750 feet of aimpoint longitudinally Speed at touchdown: maximum of 10 knots above landing speed, minimum TBD Attitude at touchdown: TBD Sink rate at touchdown: TBD
Offset Precision Landing: Touchdown (STOL aircraft)	Desired Performance Touchdown zone: within ± 10 feet of aimpoint laterally, within -25 to +75 feet of aimpoint longitudinally Speed at touchdown: maximum of 2 knots above landing speed, minimum TBD Attitude at touchdown: TBD Sink rate at touchdown: TBD No PIO
	Adequate Performance Touchdown zone: within ± 25 feet of aimpoint laterally, within -100 to +400 feet of aimpoint longitudinally Speed at touchdown: maximum of 5 knots above landing speed, minimum TBD Attitude at touchdown: TBD Sink rate at touchdown: TBD
Offset Precision Landing: Rollout and Takeoff Roll	Desired Performance Keep the nosewheel within ± 10 feet of the runway centerline No PIO
	Adequate Performance Keep the nosewheel within ± 25 feet of the runway centerline

MIL-STD-1797A
APPENDIX A

Takeoff Rotation	Desired Performance Attitude control: Keep within ± 1 degree of takeoff attitude Overshoots: no more than one overshoot, not to exceed TBD degrees No PIO
	Adequate Performance Attitude control: Keep within ± 2 degrees of takeoff attitude Overshoots: no more than one overshoot, not to exceed TBD degrees

**MIL-STD-1797A
APPENDIX A**

TABLE LVIII. Suggested performance objectives for various evaluation tasks - Cont'd.

Suggested Tasks	Suggested Performance Objectives
Takeoff Climbout	<p>Desired Performance</p> <p>Flightpath control: Keep within ± 1 degree of specified climbout angle</p> <p>Groundtrack: Keep aircraft within ± 10 feet of runway centerline or within ± 2 degrees of runway heading</p> <p>No PIO</p>
	<p>Adequate Performance</p> <p>Flightpath control: Keep within ± 2 degrees of specified climbout angle, but not less than 0°</p> <p>Groundtrack: Keep aircraft within ± 25 feet of runway centerline or within ± 5 degrees of runway heading</p>

An alternative to using a real target aircraft is to do a HUD tracking task. In this task, a target symbol (tracking bars or a line-drawing of a target) is projected on the HUD which commands pitch and roll changes that the evaluation pilot must follow. The pitch and roll commands can be combinations of steps and ramps, a smoothly-varying function (such as a sum-of-sines) or a simulated target aircraft maneuver (such as those described above). The sequence of pitch and roll commands should be designed so as to keep the aircraft within ± 1000 feet of the test attitude and within ± 50 knots of the test airspeed. The sequence should be long enough and complex enough that the pilot cannot learn to anticipate the commands. Some example sequences that have been used before are discussed in Verification Lessons Learned.

Air-to-Ground Tracking

The air-to-ground tracking task has two phases: gross acquisition and fine tracking. Gross acquisition evaluates the ability to switch from one target to another. Fine tracking evaluates the ability to continuously track a target.

For this task, the aircraft flies at a specified glideslope and airspeed toward a group of widely-spaced targets on the ground. The airspeed and glideslope should be representative of the intended operational application for the aircraft. Initial range to the targets should allow time for acquisition and tracking of several targets. The targets should be from 60 to 180 feet apart perpendicular to the flight path and anywhere from 90 to 360 feet apart parallel to the flight path. The pilot aggressively captures the first target and tracks it for a specified period of time (4 seconds is recommended), and then acquires and tracks succeeding targets. The sequence of targets to be tracked should be specified in advance. As the aircraft approaches the targets the angular displacement between the targets will increase. Therefore, at long range the sequence should require switching between the more widely-spaced targets (from one end of the group to the other end, for example). As the range closes the sequence should require switching between targets which are closer together (adjacent targets). The last target switch should require a pitch up. A minimum recovery altitude should be specified at which the pilot must abandon the task. This minimum attitude should consider the airspeed and dive angle of the task and should allow plenty of margin for the pilot to pull out. Suggested performance objectives are the same as those for air-to-air tracking. Some suggested performance objectives are given in table LVIII.

Close Formation Task

While the tracking tasks put a lot of emphasis on attitude control, close formation tasks put more emphasis on flight path control. The task consists of holding close formation with a target aircraft as it maneuvers. Both wing and trail formations are used. The performance objective is to maintain relative position between the target aircraft and the aircraft under evaluation. Specific objectives are difficult to

MIL-STD-1797A
APPENDIX A

recommend because the pilot usually uses visual alignment of some part of his aircraft against the target aircraft to gauge his position, and, of course, this will vary with evaluation aircraft and target aircraft.

MIL-STD-1797A
APPENDIX A

Some suggested displacements to use for performance objectives are given in table LVIII, however, consideration should be given to the nature of the target maneuvers. More relaxed performance objectives should be used for the more extreme target maneuvers. A procuring agency will have to determine for themselves what these numbers mean in terms of visual alignment with the target aircraft in their program.

The target maneuvers used in this task are usually the same or similar to the ones used in the air-to-air tracking task, including the ones mentioned in Verification Lessons Learned. For the long-look technique the task should be done a few times in the wing formation and then done a few times in trail formation and then rated. The pilot's objectives in this task are outside visual references which are difficult to gauge and are usually not recorded by any medium (unless a video camera is specially mounted for this task or an observer is carried in one of the aircraft).

Aerial Refueling

There are two types of aerial refueling: probe-and-drogue and flying boom. To date, evaluation tasks associated with both types of aerial refueling have not been formalized as much as those for tracking and precision landing tasks. Some formalized tasks which have been used in previous programs are described below.

For boom-type aerial refueling, the most frequently used evaluation task is some type of boom tracking task. Two approaches have been tried. The first approach is to track the nozzle of the boom with a waterline symbol or a pipper on the HUD or windscreen. The evaluation aircraft takes station in the pre-contact position about 50 feet aft and down on a 30 deg line from the tanker, which maintains steady, level flight with the boom extended. The boom may be held stationary or moved around slowly (no more than 1 deg/sec). The tracking time should be extensive for a good evaluation: two to four minutes is recommended. The performance objective is to keep the pipper or waterline symbol within a certain radius of the nozzle of the boom for a large percentage of the tracking time. Some suggested performance objectives for this approach are given in table LVIII.

In the second approach the evaluation pilot attempts to keep the end of the boom visually aligned with some point on the tanker aircraft. The evaluation aircraft maintains the pre-contact position within about ± 10 feet. In this approach the boom is held stationary. The recommended tracking time is two to four minutes. The performance objective in this approach is to keep the end of the boom visually aligned within a clearly discernible area on the tanker for a specified percentage of the tracking time. It is difficult to recommend performance objectives for this approach because they will depend on the type of tanker in use. However, an example of a project which used this approach with a KC-135 is given in Verification Lessons Learned.

For probe-and-drogue refueling actual hook-ups have been used as evaluation tasks. In one such program, the performance objective was the ratio of successful hook-ups to attempted hook-ups. The task starts from the standard pre-contact position. When cleared for contact, the evaluation pilot establishes a 3-5 knot closure rate towards the drogue and attempts to make contact. If the drogue is successfully engaged, the evaluation pilot stabilizes for approximately 30 seconds, and then establishes a 3-5 knot separation rate to disconnect and return to the pre-contact position. If the closure rate exceeds 5 knots, the probe tip passes the outside edge of the drogue basket, the probe tips the basket, or if a hazardous situation develops, the hook-up attempt is aborted and the evaluation pilot returns to the pre-contact position before making another attempt. The performance objective is a certain percentage of successful hook-ups out of a specific number of attempts. Six to twelve is the recommended number of attempts. Some suggested performance objectives are given in table LVIII.

MIL-STD-1797A APPENDIX A

Offset Precision Landing

The standard evaluation task for approach and landing is an offset precision landing. There are up to three phases in this task: approach, touchdown, and, sometimes, rollout. The approach phase evaluates the ability to control flightpath, airspeed, and attitude, including gear-down transients and large amplitude maneuvers. The touchdown phase evaluates the ability to control flightpath, airspeed, and attitude to a precise touchdown in the presence of ground effects and through touchdown transients. Rollout evaluates ground handling after touchdown.

The approach phase evaluation begins about a mile out on final approach, with gear and flaps up, at the required glideslope angle, but with a lateral offset from the runway centerline of about 150 to 300 feet, and a vertical offset from the glideslope of about 100 to 200 feet. Soon after the task begins the pilot lowers gear and flaps to the landing configuration. The pilot maintains precise flightpath angle and airspeed control throughout the approach phase up to the off set correction point. Some suggested performance objectives are given in table LVIII. Determination of performance objectives for flight path control should consider what cues are available to the pilot. Determination of performance objectives for airspeed control must consider the margin between the recommended approach speed and V_{stall} .

Lateral offsets of 200 feet or less should be corrected at 150 feet AGL. Lateral offsets of more than 200 feet should be corrected at 200 feet AGL. The pilot should make an aggressive correction to the glideslope. The correction should be completed with the wings approximately level by 50 feet AGL to avoid the possibility of striking the ground.

The touchdown phase begins at about 50 feet AGL. The pilot attempts to put the main wheels down inside a designated touchdown zone at a specified landing speed, attitude, and sink rate. The landing zone should be clearly identifiable on the runway. Performance objectives are the touchdown location, landing speed, attitude, and sink rate at touchdown. Some suggested performance objectives for conventional aircraft are given in table LVIII. Determination of performance objectives for airspeed control must consider the margin between the recommended landing speed and V_{stall} . Similarly, performance objectives for attitude at touchdown must consider aircraft geometry (to preclude wingtip or tail strikes, etc.) and landing gear limitations (side force limits, etc.). Landing gear limitations must also be considered in the determination of performance objectives for sink rate at touchdown.

Performance objectives for STOL and carrier-based aircraft should be more demanding. Suggested performance objectives for STOL aircraft are also given in table LVIII.

The rollout phase begins after touchdown. The pilot steers from the touchdown point to the runway centerline and thereafter stays on the runway centerline while bringing the aircraft to a stop. For STOL aircraft a stopping distance should be specified (usually set by mission performance requirements). Some suggested performance objectives are given in table LVIII. Landing rollout should be evaluated with and without crosswinds using rudder and nosewheel steering or differential braking. Landing rollout might also be evaluated under various runway conditions (dry, wet, icy, patched, etc.). Ground handling qualities should be expected to degrade with degraded runway conditions in a similar manner to the way handling qualities degrade with atmospheric disturbances, however, at this time there is no available guidance on how much degradation to allow under various runway conditions. The best that can be said at this time is that ground handling should be Level 1 for normal runway conditions, and if the aircraft cannot be kept on the runway under certain conditions, the aircraft should be considered uncontrollable for those conditions. As is the case in evaluations with atmospheric disturbances, dangerous runway conditions should only be tested in ground simulation.

In flight test, bringing the aircraft to a full stop on the runway on every run is in advisable due to cost and time constraints. Therefore, for the long-look technique, approach and touchdown should be evaluated by doing a few touch-and-goes before giving a C-H rating. Rollout should be evaluated on the last

MIL-STD-1797A
APPENDIX A

landing, which is brought to a complete stop. On a ground-based simulator, the aircraft should be brought to a stop every time. On ground-based simulators, pilots tend to be "lower gain" than they are in flight. To counter this, light random turbulence and fairly large discrete gusts should be introduced throughout the task. In particular, a discrete gust should be introduced after the offset correction. Degradation with atmospheric disturbances (4.9.1) should be evaluated by increasing the turbulence and the gusts and by adding crosswinds and wind shears.

Because this task is done in close proximity to the ground it should not be attempted if other evaluations (analysis, ground simulation, or flight test) indicate a high probability of Level 3 handling qualities or hazardous PIO tendencies. Therefore offset precision landing tasks should be performed on a ground-based simulator and approach handling qualities should be evaluated with other in-flight tasks (such as HQDT) before attempting actual off set precision landings in flight test. Obviously, if this task is considered too dangerous to attempt, the aircraft is considered to have failed this requirement.

Takeoff

Takeoff tasks have not been done as often as landing and tracking tasks, so there is little practical experience on which to base the task recommended here. The task consists of three phases: takeoff roll, rotation, and climb-out. The takeoff roll evaluates ground handling from brake release to takeoff rotation. The rotation phase evaluates ability to control attitude during takeoff. The climb-out phase evaluates ability to control flightpath after takeoff, including leaving ground effect and gear transients.

The takeoff roll begins from takeoff condition at the end of the runway. The pilot advances the throttles to a specified setting and releases the brakes. The task is to track the runway centerline as the aircraft accelerates. The suggested performance objectives for this phase are the same as those for landing rollout. Some suggested performance objectives for the takeoff roll are given in table LVIII.

At a specified speed the pilot briskly rotates the aircraft to takeoff attitude. Performance objectives in this phase are attitude control, number of overshoots, and size of overshoots. An overshoot in this case is defined as any deviation above the specified takeoff attitude. The purpose of the overshoot limit is to prohibit over-rotation. Some suggested performance objectives for takeoff rotation are given in table LVIII. Determination of performance objectives for overshoot are dependent on aircraft geometry and the recommended takeoff attitude.

After main wheel liftoff, the pilot maintains a specific flightpath angle and groundtrack. He maintains this flightpath until the landing gear has been retracted and all transients have settled out. Some suggested performance objectives for takeoff climbout are given in table LVIII. Determination of performance objectives for flightpath control should consider what cues are available to the pilot. In most cases pitch attitude is used as a substitute when flightpath angle is not an available cue. The tolerance for adequate flightpath control should not allow a negative flightpath angle. For groundtrack control, heading angle may be used as a substitute for deviation from runway centerline.

It would be impractical to evaluate takeoff roll with a long-look technique in flight test because the aircraft would have to land and taxi back to the end of the runway each time. However, rotation and climb-out could be evaluated with a long-look technique by doing touch-and-goes. On a ground-based simulator the entire task could be done using a long-look technique. As with the landing tasks, light random turbulence and moderate discrete gusts should be used to increase the pilot's "gain" on a ground-based simulator. Degradation with atmospheric disturbances (4.9.1) can be evaluated on the ground simulator by increasing the turbulence and gusts and by adding crosswinds and wind shears.

VERIFICATION LESSONS LEARNED

An important source of guidelines on the use of tracking techniques for handling qualities evaluation is AFFTC-TD-75-1. AFFTC-TD-75-1 discusses execution and analysis of results of both air-to-air and

MIL-STD-1797A APPENDIX A

air-to-ground techniques. Many of the recommendations in AFFTC-TD-75-1 are also applicable to other closed-loop handling qualities evaluation techniques. Further discussions of the design and conduct of handling qualities testing and the use of the Cooper-Harper scale can be found in CAL Report TB-1444-F-1, NADC-85130-60, NASA TN D-5153, AIAA 89-3358, and AIAA 90-2822.

Some of the most detailed descriptions of closed-loop evaluation tasks which have been used in the past can be found in USAFTPS and AFFTC handling qualities test plans and flight test reports. Descriptions of several tasks taken from USAFTPS Letter Reports can be found in AFFDL-TR-77-34 and AFFDL-TR-79-3126. AFFTC, handling qualities reports which contain descriptions of several closed-loop evaluation tasks include AFFTC-TR-75-15 (the YF-16), AFFTC-TR-77-11 (the A-10), AFFTC-TR-77-23 (the YF-16 Control Configured Vehicle (CCV)), AFFTC-TR-83-45 (the Advanced Fighter Technology Integration AFTI/F-16), and AFFTC-TR-91-29 (the F-15 STOL and Maneuver Technology Demonstrator (SIMTD)).

Another source of closed-loop evaluation tasks is the Standard Evaluation Maneuver Set (STEMS). The results of this project are documented in WL-TR-93-3081, WL-TR-93-3082, and WL-TR-93-3083. The main products of this project were: 1) a process to develop handling qualities evaluation maneuvers, 2) an initial set of 20 evaluation maneuvers tested in ground simulation, and 3) guidelines to help users select appropriate maneuvers. WL-TR-93-3081 describes the maneuver development process. WL-TR-93-3082 provides descriptions of the initial set of evaluation maneuvers and a selection guide. WL-TR-93-3083 documents the results of the ground simulation tests of the initial maneuver set. The maneuvers developed in this project were primarily aimed at evaluation of agility and high-angle-of-attack flying qualities, however, there were some conventional flying qualities evaluation maneuvers as well. AIAA-93-3645 provides a summary of the STEMS project.

Air-to-Air Tracking

Air-to-air tracking is one of the most commonly used handling qualities evaluation techniques. Examples of the use of this kind of task can be found in many handling qualities reports. The task descriptions and performance objectives recommended in Verification Guidance stem largely from numerous USAFTPS projects conducted in the mid-1970s to the early 1980s using the variable-stability NT-33A. The task descriptions in these projects remained fairly similar throughout this period and are documented in AFFDL-TR-77-34 and AFFDL-TR-79-3126. In the earliest of these tests the performance objectives for Cooper-Harper ratings were undefined. The performance objectives gradually became better defined with succeeding projects. The performance objectives suggested in Verification Guidance reflect the objectives used in the later projects. Similar performance objectives were used on McDonnell-Douglas and Wright Laboratory ground simulators during the development of the F-15 S/MTD (WRDC-TR-49-3036).

Some other target maneuvers which have been used in air-to-air tracking are a modified Lazy-Eight maneuver, a constant-g barrel roll, and an unpredictable target maneuver. Discussions of the use of the modified Lazy-Eight and the barrel roll maneuver can be found in AFFDL-TR-79-3126. The unpredictable target is a target which is free to maneuver within certain restrictions. Normally, it is restricted in airspeed (typically within ± 50 knots of test condition), altitude (typically within ± 1000 feet of test condition), load factor, and onset rate (typically restricted to no more than .5 g/sec).

One of the conventional evaluation tasks of the STEMS project was Tracking in Power Approach. The task was to track a target aircraft from approximately 1500 ft range in power approach configuration at approach airspeed. The target performed gradual S-turns with periods of straight flight between turns. Constant altitude was maintained during the maneuver. The evaluation pilot selected specific aim points on the target and tracked them during the maneuver. In the simulation, different target profiles were required for different Classes of aircraft. For fighter aircraft, the target performed a 30° heading change every 20 seconds. For transport aircraft, a 15° heading change was performed every 15 seconds. Desired performance was to keep the pipper within ± 5 mils of the aim point for 50% of the task and within ± 25 mils for the remainder of the task, with no PIO. Adequate performance was to keep the pipper within ± 5

MIL-STD-1797A
APPENDIX A

mils of the aim point for 10% of the task and within ± 25 mils for the remainder of the task. This maneuver can be performed at a safe altitude before attempting precision landings.

HUD tracking tasks have been used in a number of handling qualities research programs. Some example step-and-ramp tracking sequences are shown on figure 273. The sequences shown in a) and b) are pitch tracking sequences that were used on the NT-33A in USAFTPS projects (USAFTPS Report 8213-4). The two sequences shown in c) are a combined pitch and roll tracking sequence used on the NT-33A and on Calspan's variable-stability LearJet in many recent projects (Calspan Report No. 7738-24). Another type of sequence in use is a sum-of-sines. This is a frequency-based function driven by an equation such as:

$$\Theta_c = K \sum_{i=1}^n A_i \sin(\omega_i t + \phi_i)$$

where Θ_c = the commanded pitch attitude (or bank angle)
K = the task gain
n = the number of sine waves
 A_i = the amplitude of each sine wave
 ω_i = the frequency of each sine wave
 ϕ_i = the phase of each sine wave

Such a function was used in a project on the LearJet (AFFTC-TLR-93-41) using 13 sine waves evenly spaced in frequency between 0.1 and 30 rad/sec. The HUD symbology usually used in HUD tracking tasks are tracking bars, but with the computational power and electronic displays available today, it is worth considering special flight test software to provide a more definitive target.

One advantage of HUD tracking tasks is that, if the HUD update rate and HUD dynamic characteristics are duplicated in the simulators, the task itself can be identical between ground simulation, in-flight simulation, and flight test, providing a greater degree of commonality between these three stages of evaluation. Bear in mind, though, that HUD dynamic characteristics will affect handling qualities more in these tasks than in tasks such as formation flying or VFR landings.

Air-to-Ground Tracking

Previous flight test programs which have used air-to-ground tracking techniques include the A-10 (AFFTC-TR-77-11 and Brandeau, AFFDL-TR-78-171), YF-16 CCV (AFFTC-TR-77-23), and AFTI/F-16 (AFFTC-TR-83-45). A very promising system for an air-to-ground tracking task called GRATE (Ground Attack Targeting Equipment) was developed and tested by the Deutsche Forschungs-und Versuchsanstalt fur Luft-und Raumfahrt (DFVLR) in the 1980s (Koehler, NASA CP 2428 and Koehler, AGARD-CP-452). This task used a pattern of lights on the ground as a target. The pilot acquires and tracks each light in turn as the lights are illuminated in a specific sequence. The Germans evaluated this task with an AlphaJet with great success. The task was also subsequently used successfully on a ground-based simulator (Biezd, AFWAL-TR46-3093). In 1987 the Dryden Flight Research Center (DFRC) developed a derivative system known as the Adaptable Target Lighting Array System (ATLAS). This system has been tested with the NT-33 (USAFTPS-TR-88A-TM 1), the X-29 (NASA TM 101700), and the F-15 S/MTD. An example of a typical ATLAS array is shown on figure 274. The ATLAS system is currently operational at DFRC at Edwards AFB.

MIL-STD-1797A
APPENDIX A

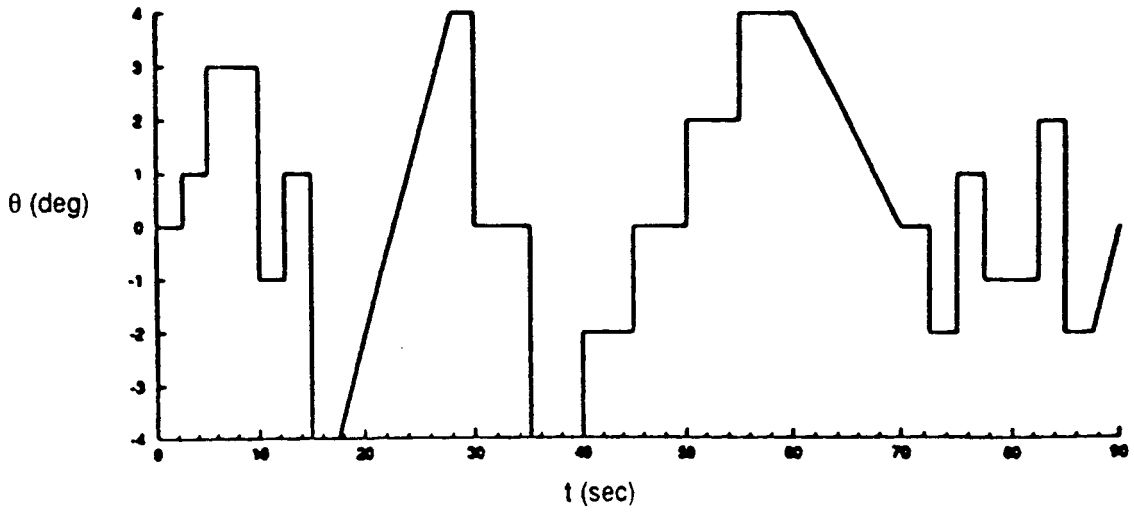

a) Pitch tracking task

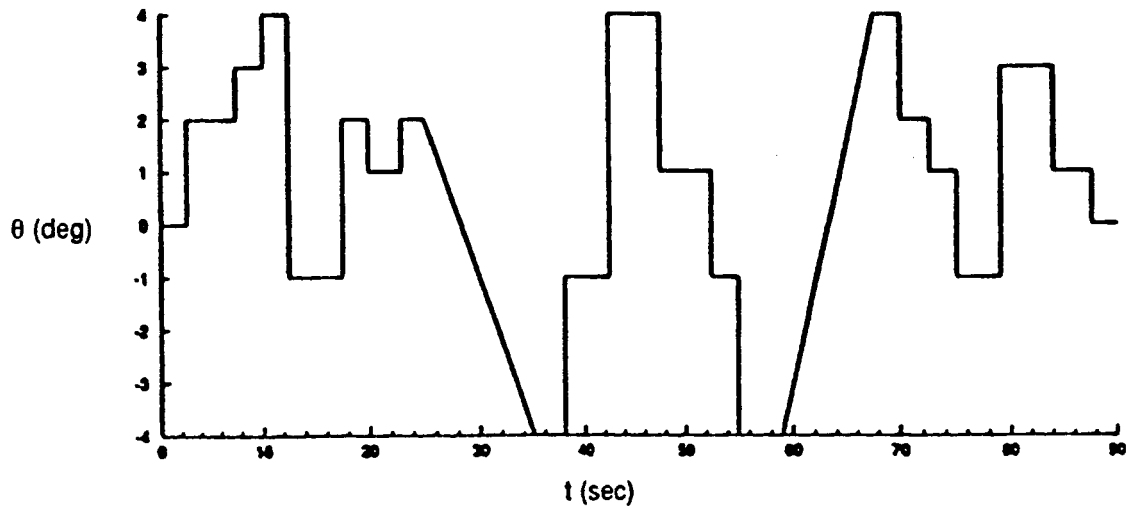

b) Pitch tracking task

FIGURE 273. Example step-and-ramp HUD tracking sequences.

MIL-STD-1797A
APPENDIX A

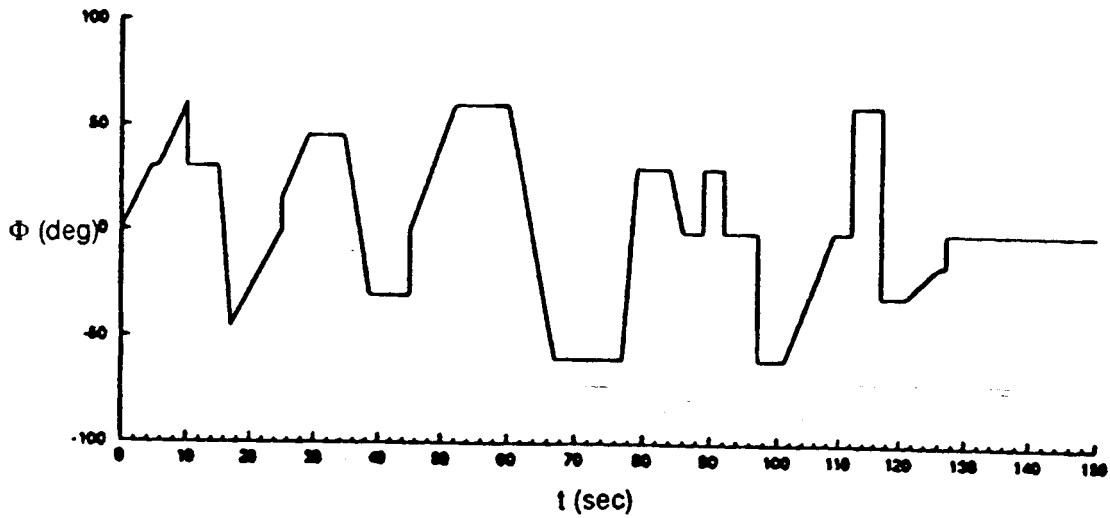
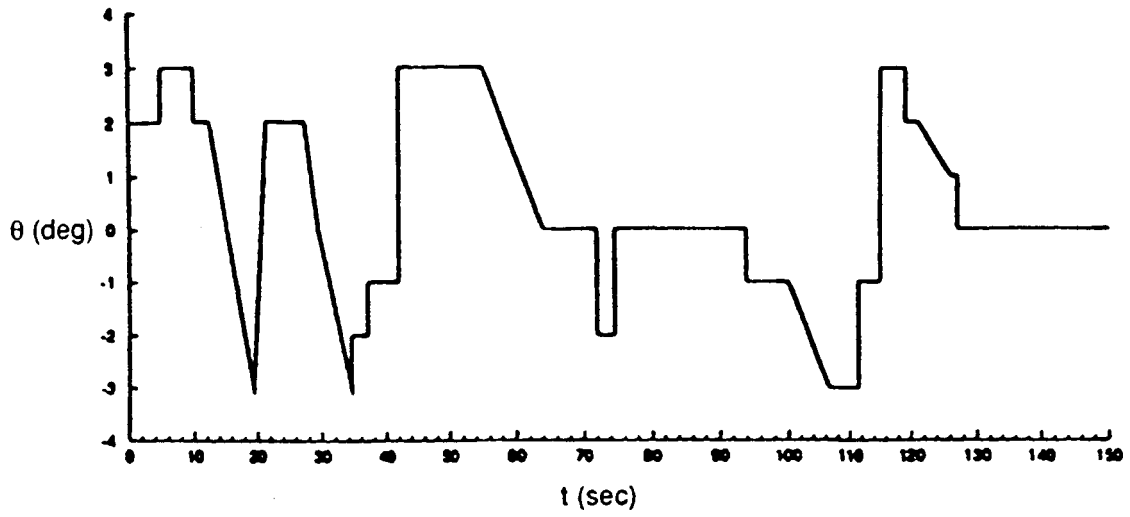

c) Combined pitch and roll tracking task

FIGURE 273. Example step-and-ramp HUD tracking sequences - continued.

MIL-STD-1797A
APPENDIX A

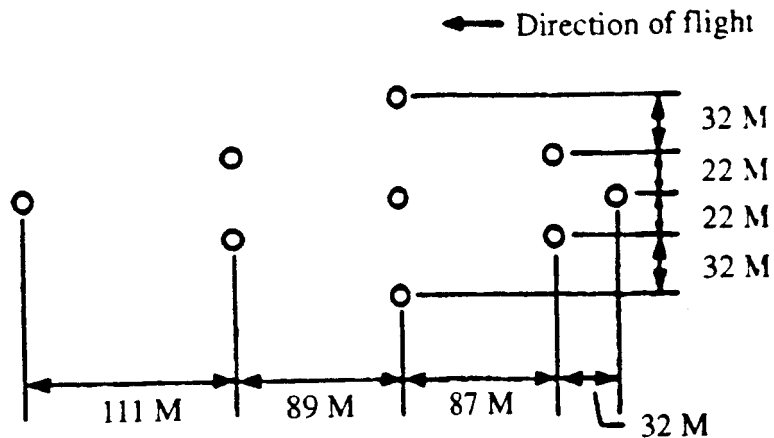

FIGURE 274. Typical ATLAS light pattern (from NASA TM 101700).

Close Formation Task

Formation flying tasks were used in the evaluations of the YF-16 CCV (AFFTC-TR-77-23), the AFTI/F-16 (AFFTC-TR-83-45), and the F-15 S/MTD (AFFTC-TR-91-29 and WL-TR-92-3027). The YF-16 CCV evaluation included station keeping and position changes during straight and level flight and in "mild to moderate" lazy-eight maneuvers. Vertical and horizontal position changes of 500 feet and 50 feet were made.

AFTI/F-16 formation tasks were done in close trail and wingtip positions. The following descriptions are taken from AFFTC-TR-83-45.

"The close trail evaluations were conducted with the AFTI/F-16 in a position ten feet below the lead aircraft with zero to ten feet nose-to-tail separation. The lead aircraft flew between 250 to 300 KCAS while making gentle maneuvers. This maneuvering included bank angle variations up to 30 degrees and gentle climbs and descents."

"The close formation evaluations were conducted with the AFTI/F-16 in a tight position off the wing of the lead aircraft. After a reasonable buildup, the AFTI/F-16 pilot flew as close to the lead aircraft as was comfortable. The lead aircraft flew either in level flight or through a series of lazy eight maneuvers. Bank angle changes ranged between ± 90 degrees, pitch attitude ranged between ± 45 degrees, airspeed between 200 and 500 KCAS and load factor between one and five g's. In this task the pilots attempted to maintain a precise position relative to the lead aircraft using fingertip formation techniques. The AFTI/F-16 would intentionally make lateral and vertical deviations in order to evaluate the aircraft's ability to return to the nominal position."

In the F-15 S/MTD program a formation task was used to evaluate PIO tendencies in power approach. The pilot attempted to maintain formation with an A-37 while the A-37 performed random 0.25-g step inputs (three to five foot vertical variations).

Aerial Refueling

Boom tracking with a HUD pipper or a waterline symbol has been done in several programs at AFFTC. In every case, however, it was done using the HQDT technique (described in 5.1.11.6 Verification Guidance), where the objective was zero pipper error. At this time there is no data to support the suggested performance objectives for this task other than the fact that these objectives have been successfully applied in other kinds of tracking tasks.

**MIL-STD-1797A
APPENDIX A**

Boom tracking using visual alignment with the tanker was proposed as a handling qualities task by the 4950th Test Wing in a flight test project to develop an aerial refueling evaluation task for Class III aircraft. The tanker aircraft in their project was a KC-135. The visual desired zone for their task was between the rivet lines on the bottom of the KC-135. The adequate zone was the edges of the fuselage. A diagram of these zones is shown in Figure 275. In the test they used two different evaluation aircraft: a C-135 and a C-18. The performance objective was the cumulative time the evaluation pilot could keep the boom nozzle aligned within the desired zone during two minutes of tracking. Four different levels of desired performance were tested: 30 seconds, 45 seconds, 60 seconds, and 75 seconds. Adequate performance was defined as keeping the nozzle within the adequate zone for the entire 2 minutes. Unfortunately, the pilots considered both aircraft Level 2 for this task because of the amount of compensation required. The results for all four levels of desired performance gave Level 2 C-H ratings for both aircraft, thus the C-H ratings give no indication of which is the best value to use for desired performance. The results do lend credence to their choice of adequate criteria, but this was not a variable in the test. Nevertheless, based on the performance achieved with both aircraft throughout the project, the pilot consensus was that 60 seconds in the defined desired zone (or about 50% of the tracking time) was "both attainable and realistic" and that the task was demanding enough to expose undesirable handling qualities. This project was documented in 4950-FTR-93-05.

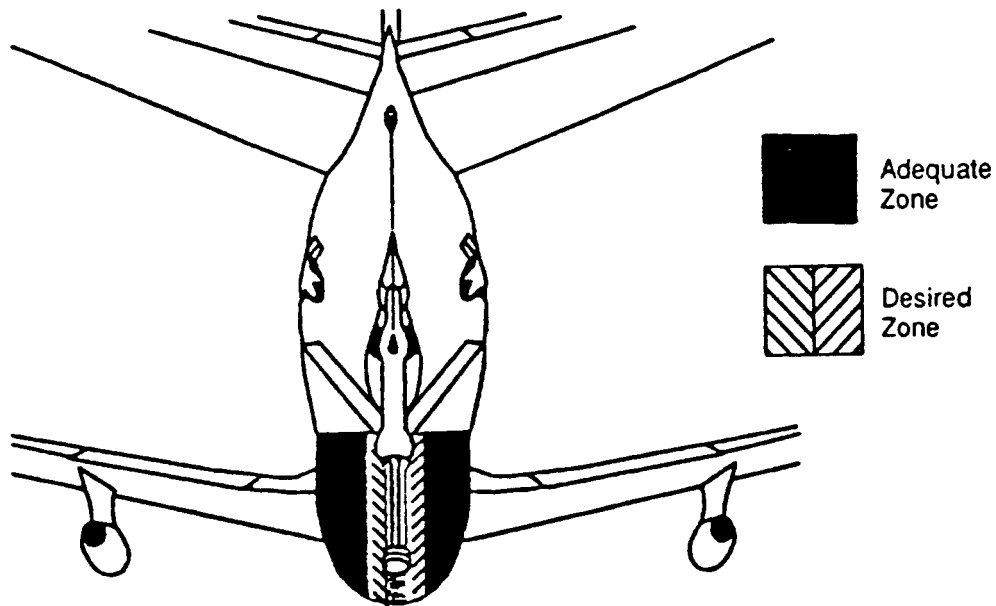

**FIGURE 275. Adequate and desired performance for 4950th
boom tracking task (from 4950-FTR-9345).**

The STEMS project also tested a boom tracking task. The task was to track the refueling probe of a tanker from the pre-contact position. The evaluation pilot can track a steady probe, periodically changing aim points on the boom (such as the boom wingtips), or the boom operator can make small random horizontal and vertical movements with the boom to create tracking errors. Desired performance in the STEMS project was to maintain the aim point within a 30-mil radius of the piper for at least 50% of the task, with no objectionable PIOs. Adequate performance was to maintain the aim point within a 50-mil radius of the piper for at least 50% of the task.

MIL-STD-1797A APPENDIX A

Probe-and-drogue refueling was used as an evaluation task in an experiment with the NT-33A documented in AFFDL-TR-74-9. Standard probe-and-drogue refueling procedures were used. However, adequate and desired performance objectives were not explicitly defined for this project. The performance objectives suggested in Verification Guidance are taken from a USAFTPS study of response-types, for probe-and-drogue refueling performed with the NT-33A in October 1993.

A position-keeping evaluation task has been used extensively for tanker evaluations including the S-3 with a buddy store, the KC-10, the KC-130, and the KC-135. A detailed description of this test technique and lessons learned from these test programs is provided in AGARD CP-519.

Offset Precision Landing

This is another task which is so widely used for handling qualities evaluations that descriptions of it can be found in many handling qualities reports, particularly those that deal with approach and landing. The suggested performance objectives for the approach and touchdown phases are taken largely from Calspan experience with the NT-33A and the Total In-Flight Simulator (TIFS). Discussions of the use of this task can be found in NASA CR 172491, NASA CR 178188, AFWAL-TR-81-3118, and AIAA 93-3816.

Some data on the size of the suggested landing zone was provided in a USAFTPS project which studied the effect of different performance objectives on touchdown C-H ratings with three different Class IV aircraft: the F-15D, the F-16D, and the F/A-18B. The experiment looked at three different desired landing zones: 25 feet wide by 200 feet long, 50 feet wide by 400 feet long, and 75 feet wide by 600 feet long. C-H ratings for each aircraft and each landing zone were compared with the pilots' qualitative appraisal of each aircraft. For the 75x600 foot zone, all three aircraft received basically Level 1 C-H ratings. For the 50x400 foot zone, the F/A-18 received basically Level 1 C-H ratings, the F-15 had borderline Level 1/Level 2 C-H ratings, and the F-16 got basically Level 2 C-H ratings. For the 25x200 foot zone, all three aircraft received basically Level 2 C-H ratings. The project report found the results from the 50x400 foot zone to be most representative of the pilots' qualitative opinions of each aircraft.

Additional data on the size of the suggested landing zone was provided in a project by the 4950th Test Wing which studied the effect of different performance objectives on touchdown C-H ratings with three different Class III aircraft: the C-141A, the C-135A/E, and the C-18B. The experiment looked at four different desired landing zones: 20 feet wide by 200 feet long, 40 feet wide by 400 feet long, 60 feet wide by 800 feet long, and 80 feet wide by 1000 feet long. C-H ratings for each aircraft and each landing zone were compared with the pilots' qualitative appraisal of each aircraft. All three aircraft were considered Level 2 for the landing task. The final report (4950-FTR-93-05) recommended the 40x400 foot zone. For this zone, desired performance was met 6 out of 12 times, and the pilot ratings comprised two C-H ratings of 3 and four C-H ratings of 4. Interestingly, this suggested landing zone is very similar to the one recommended by USAFTPS for Class IV aircraft.

The performance objectives for STOL aircraft are taken from experience on the F-15 S/MTD program. Discussions of the tasks used in the S/MTD program can be found in AFWAL-TM-87-180-FIGC, WRDC-TR-89-3036, AFFTC-TR-91-29, and WL-TR-92-3027.

Takeoff

The takeoff task described in Verification Guidance was taken from the F-15 S/MTD program. This task was only used as an evaluation task on the McDonnell-Douglas and Wright Laboratory simulators. It was not used as an evaluation task in the flight test program. Descriptions and results of the use of this task can be found in AFWAL-TM-87-180-FIGC and in WRDC-TR-89-3036.

MIL-STD-1797A
APPENDIX A

4.1.7 Aircraft Failure States.

The contractor shall define and tabulate all Aircraft Failure States which can affect flying qualities. Aircraft Failure States consist of Aircraft Normal States modified by one or more malfunctions in aircraft components or systems; for example, a discrepancy between a selected configuration and an actual configuration. Those malfunctions that result in center-of-gravity positions outside the center-of-gravity envelope defined in 4.1.1 shall be included. Each mode of failure shall be considered in all subsequent Flight Phases.

REQUIREMENT RATIONALE (4.1.7)

This tabulation is the starting point for a failure modes and effects analysis, which is necessary in a complex aircraft to assure flying qualities adequate for mission effectiveness and flight safety.

REQUIREMENT GUIDANCE

The related MIL-F-8785C paragraph is 3.1.6.2.

Because of the exhaustive work often involved and low confidence in the failure probability calculations, there is a tendency for the procuring activity to substitute a prior list of specific failures. If a design is far enough along and not excessively complex, such an approach can work. See the guidance for 4.1.7.1. However, generally comprehensive reliability analyses will be required anyway.

Whether the approach to failure effects on flying qualities is probabilistic, generic or a combination, failure possibilities of the specific aircraft must be catalogued thoroughly enough to assure adequate mission effectiveness and flight safety.

REQUIREMENT LESSONS LEARNED

There is more to determining Failure States than just considering each component failure in turn. Two other types of effects must be considered. First, failure of one component in a certain mode may itself induce other failures in the system, so failure propagation must be investigated. Second, one event may cause loss of more than one part of the system or can affect all channels: a broken bracket, a single crack, a fire, an electrical short, inadequate ground checkout, etc. The insidious nature of possible troubles emphasizes the need for caution in design applications.

5.1.7 Aircraft Failure States - verification.

The contractor shall furnish the required data in accordance with the Contract Data Requirements List.

VERIFICATION RATIONALE (5.1.7)

Definition of aircraft failure states is basic to the application of the flying qualities requirements.

VERIFICATION GUIDANCE

Generally, compliance will amount to identifying pertinent items from the list required by the reliability specification, and checking for completeness. Although the task may seem formidable, the alternative to a thorough review is a certainty that something important will be overlooked.

VERIFICATION LESSONS LEARNED

**MIL-STD-1797A
APPENDIX A**

TABLE X. Control-margin increments.

Flying Quality	$\Delta\delta_{FQ} / \Delta n_c = 57.3 \text{ CAP}' / M_\delta \text{ deg/g (for } T_{\text{eff}} \leq 0.5)$
Stabilization	$\Delta\delta_{\text{stab}} / \Delta n_c = 57.3 \frac{g}{U_o} \cdot \frac{1/T_{\text{sp}_1} \cdot 1/T_{\text{sp}_2}}{M_\delta \cdot 1/T_{\Theta_2}} \text{ deg/g (linear, 2 DOF)}$
Turbulence	σ_δ / σ_w fn of $M_w, M_\delta, \omega_{\text{sp}_{cl}}, \zeta_{\text{sp}_{cl}}$, structural m - most severe at low \bar{q} - $3\sigma_\delta$ and σ_w for severe turbulence recommended
Sensor Noise	σ_δ / σ_s fn of $K_s, K_F, \omega_s, 1/T_a, \omega_{\text{sp}_{cl}}, \zeta_{\text{sp}_{cl}}, \omega_{\text{sp}_{cl}}^2$
Flying Quality	$\dot{\delta}_{FQ} / n_c = 57.3 \text{ CAP} / (M_\delta \cdot T_{\text{eff}})$ for desired CAP
Stabilization	$\dot{\delta}_{\text{stab}} / n_c < \dot{\delta}_{FQ} / n_c$ if FCS stability margins OK & $\frac{1}{T_{\text{eff}}} > \omega_c$ $\dot{\delta}_{\text{stab}} / n_c$ fn of $1/T_{\text{eff}}, 1/T_{\text{sp}_2}, \omega_{\text{sp}_{cl}}, \zeta_{\text{sp}_{cl}}$ if FCS stability margins OK & $\frac{1}{T_{\text{eff}}} > \omega_c$
Turbulence	σ_δ / σ_w fn of $1/T_a, \omega_{\text{sp}_{cl}}, \zeta_{\text{sp}_{cl}}, M_\delta$ - most severe at low \bar{q} - $3\sigma\dot{\delta}$ recommended for control margin
Sensor Noise	$\sigma_\delta / \sigma_s = K_s, K_F \cdot \text{fn}(\omega_s, 1/T_a \text{ and, for low } \omega_{\text{sp}_{cl}} : \omega_{\text{sp}_{cl}}^2, \omega_{\text{sp}_{cl}}, \zeta_{\text{sp}_{cl}})$ - These parameters are not all independent - $3\sigma\dot{\delta}$ recommended for control margin

Δn_c is the commanded increment of normal acceleration
$1/T_2$ is the unstable pole of the transfer function (negative, 1/sec)
$\omega_{\text{sp}_{cl}}^2$ is the 2-deg-of-freedom product of the poles, $1/\text{sec}^2$
$\omega_{\text{sp}_{cl}}$ and $\zeta_{\text{sp}_{cl}}$ are the closed-loop frequency and damping ratio of the short period mode
CAP is $\dot{q}_o / \Delta n_{oo}$, CAP' is $\dot{q}_{\text{max}} / \Delta_{oo}$
ω_s is the sensor bandwidth
K_s, K_F are the sensor and forward-loop gains
σ_s, σ_w are the rms intensities of sensor noise and vertical gusts
ω_c is the crossover frequency of the $\dot{\delta} / n_c$ transfer function
T_{eff} is the effective time constant of command-path plus forward-path control-loop elements (such as prefilters and actuators)
T_a is the time constant of actuator ram

MIL-STD-1797A
APPENDIX A

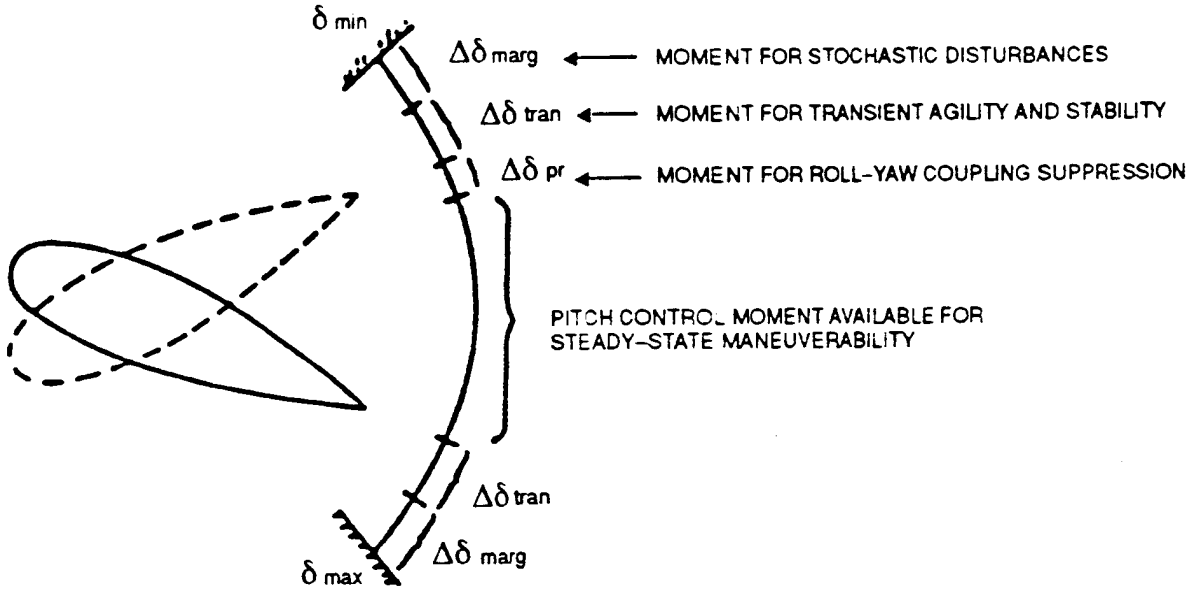

FIGURE 11. Control margin requirements.

MIL-STD-1797A
APPENDIX A

4.1.11.6 Pilot-in-the-loop oscillations (PIO).

There shall be no tendency for pilot-in-the-loop oscillations, that is, sustained or uncontrollable oscillations resulting from efforts of the pilot to control the aircraft. More specific requirements are in 4.2.1.2, 4.2.2, 4.5.2, and 4.6.3.

REQUIREMENT RATIONALE (4.1.11.6)

This general qualitative requirement, applicable to all axes, covers those axes of control for which there is no data base for more specific requirements.

REQUIREMENT GUIDANCE

The applicable MIL-F-8785C requirements are paragraphs 3.2.2.3 and 3.3.3.

PIOs were a consideration in setting the boundaries of 4.2.1.2 and 4.5.1.3 through 4.5.1.5.

REQUIREMENT LESSONS LEARNED

Likely causes are equivalent time delay control system friction, inappropriately-located zeros of aircraft transfer functions, or nonlinearities such as rating limiting, hysteresis, and abrupt control system gain changes. See the discussion under 4.2.2. NORAIR Rpt No. NOR-64-143 discusses a number of possible PIO mechanisms.

5.1.11.6 Pilot-in-the-loop oscillations (PIO) – verification.

Verification shall be by analysis, simulation, and flight test. Final verification shall be by demonstration in the following tasks: _____.

VERIFICATION RATIONALE

The need to use high-gain, closed-loop tasks to evaluate handling qualities, in addition to comparison with open-loop requirements if fully discussed in the Verification Rationale of 5.1.6.1 through 5.1.6.3. An additional reason, if any more are needed, is that most of the open-loop requirements assume a linear system. Pilot evaluation in high-gain, closed-loop tasks is at this time the best evaluation of the effects of nonlinearities. This is particularly important in the evaluation of PIO tendencies because nonlinearities, such as rating limiting, hysteresis, abrupt gain changes, and aerodynamic nonlinearities, are some of the common causes of PIO.

VERIFICATION GUIDANCE

Pilot-vehicle analysis in the manner described in the discussion of the cited paragraphs should help in the design stage. Ground-based simulation may or may not show up any PIO tendencies. Flight evaluation in variable-stability aircraft is a valuable tool. Final determination will come from flight test of the actual vehicle.

The recommended tasks to demonstrate compliance with this requirement are the tasks described in Verification Guidance of 5.1.6.1 through 5.1.6.3 using the HQDT technique. AFFTC makes a distinction between HQDT and “operational” closed-loop evaluation tasks. The key element of the HQDT technique is that the pilot must attempt to totally eliminate any error in the performance are not defined and aggressive control strategy that he can. Adequate and desired performance are not defined and Cooper-Harper ratings are not recommended. The reason for this is that, in the “operational” tasks, definition of adequate and desired performance encourages the pilot to adopt a control strategy which best meets these performance objectives. In the case of a PIO-prone airplane, attempting to totally eliminate any deviation may induce oscillations which reduce his performance, but by accepting small errors (reducing his gain) the pilot may be able to avoid these oscillations and still meet the performance objectives (which, by their definition, allow such a tactic). The HQDT technique does not allow the pilot to do this, thus exposing any possible handling qualities deficiencies. HQDT could be considered a “stress test” of handling qualities. For this reason, the HQDT technique is considered the best test of PIO tendencies.

HQDT is not exclusively a PIO evaluation technique. It is a general handling qualities evaluation technique. It is discussed in more detail here in the PIO requirement because it is a better PIO

**MIL-STD-1797A
APPENDIX A**

"operational" technique uses performance objectives more representative of operational use, and the C-H ratings provide a quantitative measure of flying qualities which can be related to the required Levels. Therefore, use of both techniques is recommended in the flight test evaluation, as well as parameter identification techniques and capture tasks. As mentioned in the Verification Rationale of 5.1.6.1 through 5.1.6.3, the recommended parts of the handling qualities evaluation are: 1) steps, doublets, and frequency sweeps for parameter identification and comparison to open-loop requirements, 2) capture tasks for pilot familiarization with aircraft dynamic response and evaluation of gross acquisition, 3) HQDT for initial handling qualities and PIO evaluation (HQDT may also provide good inputs for frequency-domain analysis), and 4) "operational" tasks for handling qualities evaluation with C-H ratings.

The PIO tendency classification scale shown on figure 12 has been developed specifically for evaluation of PIO tendencies. It can be used with either the HQDT or the "operational" techniques. Comparing the PIO rating descriptions with descriptions of Levels of flying qualities, a rough approximation would be: PIO ratings of 1 or 2 would be Level 1, PIO ratings 3 or 4 would be Level 2, and a PIO rating of 5 would be Level 3. A PIO rating of 6 would be extremely dangerous.

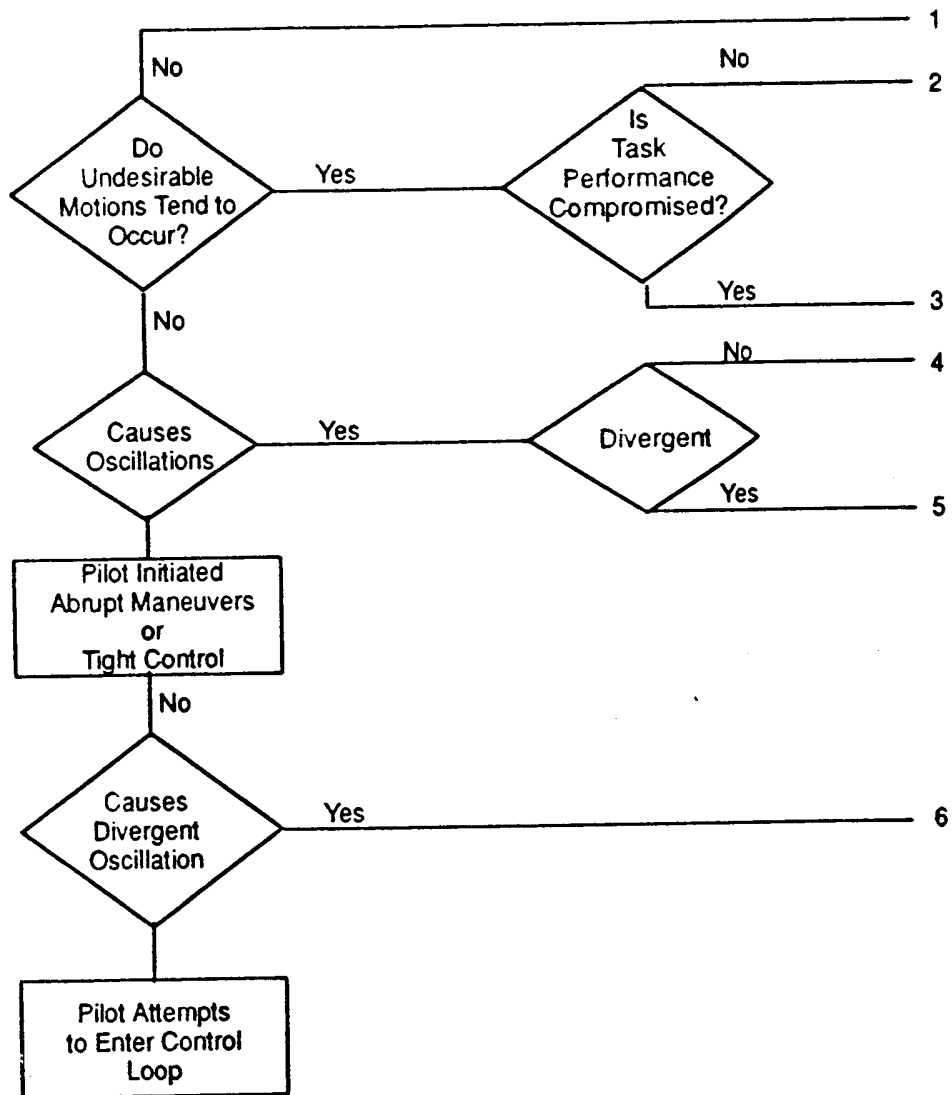

FIGURE 12. PIO tendency classification from AFWAL-TR-81-3118.

MIL-STD-1797A
APPENDIX A

Tom Twisdale provides some guidance on possible HQDT tasks:

Probably any test maneuver that allows the evaluation pilot to aggressively and assiduously track a precision aim point is a suitable HQDT test maneuver. In HQDT testing, the test maneuver is not nearly as important as the piloting technique. It is the piloting technique that increases the evaluation pilot's bandwidth and makes possible a good handling qualities evaluation. For this reason there is no exclusive catalog of HQDT maneuvers. The ones discussed below have worked well, but others, perhaps better suited to a particular airplane, may be invented as the need arises.

Air-to-Air HQDT

Air-to-Air HQDT involves tracking a precision aimpoint on a target airplane while using a fixed, or non-computing gunsight. There are three main variations of air-to-air HQDT: constant load factor HQDT at a constant range of about 1500 feet; wind-up turn HQDT at a constant range of about 1500 feet; and HQDT while closing on the target.

The purpose of a constant load factor air-to-air HQDT maneuver is to evaluate handling qualities at a specific angle of attack. The maneuver begins with the test airplane positioned 1500 feet behind and offset above, or below, or to the inside of the target. The offset position is helpful in avoiding jetwake encounters. At the evaluation pilot's signal the target pilot rolls smoothly into a turn and slowly increases load factor until the test load factor is attained. A g onset rate of two seconds or so per g is satisfactory. When the test load factor has been attained the target pilot calls "on condition" and maintains the turn and the test conditions for the specified period of time, which will depend on the test and analysis objectives. During the load factor build-up the evaluation pilot turns on the airborne instrumentation system and positions the target airplane 50 mils or so from the pipper or aiming index at a clock position of 1:30, 4:30, 7:30, or 10:30. After the target pilot calls "on condition" the evaluation pilot calls "tracking" and drives the pipper toward the precision aim point to initiate the evaluation. The evaluation pilot continues to track while using the HQDT piloting technique, until the target pilot or other aircrew or the control room calls "time". However the maneuver is not concluded until the evaluation pilot calls "end tracking". At that time the target pilot rolls out of the turn.

The constant load factor air-to-air HQDT maneuver may be a constant turn to the left or right, or turn reversals may be included. When reversals are included they should be performed at constant load factor. The evaluation pilot continues to track the precision aim point throughout the reversal, always using the HQDT piloting technique.

The evaluation pilot should maintain a 1500-foot separation from the target airplane. Variations of a few hundred feet either way are permissible, but range to the target should not be allowed to exceed 2000 feet. Range may be determined stadiometrically with adequate accuracy.

The purpose of a wind-up turn air-to-air HQDT maneuver is to quickly explore handling qualities across a range of angle of attack. The maneuver gets under way when the target pilot establishes the test conditions and calls "on condition". The evaluation pilot positions the test airplane 1500 feet behind and offset above, or below, or to the inside of the target. The offset position is helpful in avoiding jetwake encounters. The evaluation pilot turns on the airborne instrumentation system and positions the target airplane 50 mils or so from the pipper or aiming index at a clock position of 1:30, 4:30, 7:30, or 10:30. The evaluation pilot then signals at the target pilot to begin the maneuver. The target pilot rolls smoothly into a turn and slowly increases load factor at a g onset rate of five or six seconds per g. As the target airplane begins rolling into the wind-up turn, the evaluation pilot calls "tracking" and drives the pipper toward the precision aim point to initiate the evaluation. The evaluation pilot continues to track while using the HQDT technique, until the target pilot attains the target load factor and calls "target g". The target load factor is maintained until the evaluation pilot calls "end tracking". At that time the target pilot may unload and roll out of the turn.

MIL-STD-1797A
APPENDIX A

The evaluation pilot should maintain a 1500-foot separation from the target airplane. Variations of a few hundred feet either way are permissible, but range to the target should not be allowed to exceed 2000 feet. Range may be determined stadiometrically with adequate accuracy.

In HQDT with closure, the evaluation pilot slowly closes on the target airplane while tracking. The purpose of the closing HQDT maneuver is to help the evaluation pilot distinguish attitude dynamics from normal and lateral acceleration dynamics. Attitude dynamics are evident at any tracking range, but translation caused by normal and lateral acceleration become more noticeable as the evaluation pilot closes on the target.

In a closing HQDT maneuver the target airplane may either fly straight and level, maneuver gently in pitch and roll, or perform a constant load factor turn. Gently maneuvering or a constant load factor turn is often preferred because it helps to increase the evaluation pilot's bandwidth. In all other respects the closing maneuver is similar to a constant load factor or wind-up tracking turn.

The closing HQDT maneuver can begin once the target pilot has established the test conditions and calls "on condition". The evaluation pilot positions the test airplane 1500 feet behind and above, below, or to the inside of the target; turns on the airborne instrumentation system; and positions the target airplane 50 mils, or so from the pipper or aiming index at a clock position of 1:30, 4:30, 7:30, or 10:30. The evaluation pilot then signals the target pilot to begin the maneuver. The target pilot flies straight and level; or begins to maneuver gently and randomly in pitch and roll; or performs a constant load factor turn. The evaluation pilot calls "tracking" and drives the pipper toward the precision aim point to initiate the evaluation. The evaluation pilot continues to track, using the HQDT technique, while slowly dosing on the target airplane. The rate of closure will depend on the desired tracking time (which will depend on the test and analysis objectives). The evaluation pilot may find it easier to control the rate of closure with the control room or the target pilot or other aircrew announce the elapsed time in five second increments. At the end of the specified tracking time, the target pilot or other aircrew or the control room calls "time". However the maneuver is not concluded until the evaluation pilot calls "end tracking".

Power Approach HQDT

Power approach HQDT is air-to-air HQDT performed with the test airplane configured for power approach. This maneuver is designed to evaluate approach and landing handling qualities at a safe altitude (10,000 to 15,000 feet), rather than a few feet above the ground during a real landing. Power approach HQDT may be flown with or without closure, however closure is a desirable feature because it helps the evaluation pilot distinguish between attitude and translation dynamics.

The target airplane may either fly straight and level or maneuver gently in pitch and roll. Maneuvering gently is often preferred because it helps to increase the evaluation pilot's bandwidth. In all other respects the power approach HQDT maneuver is similar to a closing HQDT maneuver.

Closure during the maneuver is useful for distinguishing attitude dynamics from normal and lateral acceleration dynamics. Attitude dynamics are evident at any tracking range, but translation caused by normal and lateral acceleration become more noticeable as the evaluation pilot closes on the target.

Jet-wake encounters are a frequent source of difficulty during power approach HQDT testing. Simple geometry, together with a maneuvering target airplane, make jet-wake encounters difficult to avoid. The slow speeds introduce the risk that a jet-wake encounter will precipitate a stall or departure, although this has never occurred. There are two solutions to the problem of jet-wake encounters. One is to use a small propeller-driven airplane as a target. Excellent candidates are the T-34C or Beechcraft Bonanza, or similar airplanes.

MIL-STD-1797A APPENDIX A

These airplanes can easily match the slowest speeds of most military airplanes, and they produce very little propwash. The second solution is to use a target that is programmed into a flight test head-up display, similar to the head-up display used on the Calspan NT-33.

Air-to-Ground HQDT

Air-to-ground HQDT involves tracking a precision aimpoint on the ground with a fixed, or non-computing gunsight. Shallow or steep dive angles may be used. Shallow dive angles approximate strafing attack profiles and steeper angles approximate ballistic weapons delivery profiles.

The evaluation pilot trims the airplane at the specified dive entry altitude and airspeed, turns on the airborne instrumentation system, calls "on condition", and rolls or pitches to the specified dive angle. When the outer ring of the gunsight reticle crosses the precision aim point, the evaluation pilot calls "tracking" and commences to track the precision aim point using the HQDT piloting technique. The evaluation pilot continues to track until the recovery altitude is reached, then calls "end tracking" and recovers from the dive.

A useful variation on the basic maneuver is to track two or more precision aim points, instead of one. For example, precision aim points may be positioned at each apex of an imaginary isosceles triangle laid out on the ground. This triangle has a base of 100 feet and a height of 375 feet (for 15 degree dive angles) or a height of 100 feet (for 45 degree dive angles) . During the maneuver the evaluation pilot randomly switches from one precision aim point to another, perhaps at a signal from the control room.

Boom Tracking HQDT

In boom tracking, the evaluation pilot tracks the nozzle on an aerial refueling boom. This maneuver is designed to explore aerial refueling handling qualities without the risk of close proximity to a tanker and a refueling boom.

The tanker airplane establishes the test conditions of Mach number (or airspeed) and altitude and maintains them during the test maneuver. The boom operator positions the refueling boom at zero degrees of azimuth and a midrange elevation angle. When the test conditions have been established the tanker pilot or the boom operator call "on condition". The evaluation pilot moves the test airplane into position a short distance behind the nozzle (20 to 50 feet) and positions the nozzle about 50 mils from the pipper or aiming index at a clock position of 1:30, 4:30, 7:30, or 10:30. To begin the maneuver, the evaluation pilot turns on the airborne instrumentation system, calls "tracking", and drives the pipper toward the nozzle. The evaluation pilot continues to track the nozzle, using the HQDT piloting technique, while the boom operator randomly maneuvers the refueling boom in azimuth and elevation. The boom motion should be a combination of gentle and abrupt changes in rate and position. After the specified period of tracking time (which will depend on the test and analysis objectives) has elapsed, the control room or another crew member calls "time". The maneuver is not concluded, however, until the evaluation pilot calls "end tracking".

Formation HQDT

In formation HQDT, the evaluation pilot attempts to maintain a precisely defined position relative to the lead airplane during a series of gentle maneuvers. Properly done, formation HQDT can highlight for the evaluation pilot the vertical and lateral translation dynamics of the test airplane. This maneuver is also useful for evaluating the throttle response of the airplane. Care must be taken not to force the evaluation pilot to fly too close to the lead airplane. Close proximity can increase bandwidth, but too close proximity can reduce it. As the separation between airplanes narrows, good and prudent pilots will reduce their bandwidth to reduce the risk of collision.

MIL-STD-1797A
APPENDIX A

Attention to flying qualities per se during flight control design will take care of many potential problems. PIOs may occur early in the aircraft life as on the YF-16 high speed taxi test that got airborne before its first flight, or later in service, as with the T-38 as more pilots got to fly it. If PIO is not found readily, it should be sought during the flight test program.

MIL-STD-1797A
APPENDIX A

4.2.2 Pilot-in-the-loop pitch oscillations.

There shall be no tendency for sustained or uncontrollable pitch oscillations resulting from efforts of the pilot to control the aircraft. The phase angle of the pitch attitude frequency response to pitch stick force at the criterion frequency, ω_c , shall be greater than or equal to _____. If this phase angle is less than _____, the phase parameter of normal acceleration at the pilot's station, ϕ , at the same criterion frequency, shall be greater than or equal to _____. Furthermore, the requirements of 4.2.1.2, 4.2.8.1, 4.2.8.2, and 4.2.8.4 must be met.

REQUIREMENT RATIONALE (4.2.2)

The purpose of this requirement is to insure that abrupt maneuvers or aggressive tracking behavior will not result in instabilities of the closed-loop pilot/aircraft system. Any such tendency will degrade or even destroy mission effectiveness and likely will be dangerous.

REQUIREMENT GUIDANCE

The related MIL-F-8785C requirement is paragraph 3.2.2.3.

Recommended values:

The recommended minimum phase angle of the pitch attitude frequency response to the pitch stick force at the criterion frequency, ω_c , is -180° .

The value of ω_c is determined as follows:

$$\omega_c (0.24 \text{ rad-oct/dB-sec}) \bar{S} + 6.0 \text{ rad/sec}$$

where \bar{S} is the average slope of $\left| \frac{\Theta(s)}{F_{es}(s)} \right|$ in dB/oct over the interval from 1 to 6 rad/sec.

If the phase angle of pitch attitude frequency response to pitch stick force is less than -160° , then the recommended minimum value of the phase parameter of normal acceleration at the pilot's station, ϕ , at ω_c is -180° .

The phase parameter of normal acceleration at the pilot's station, ϕ , is defined by:

$$\phi(\omega_c) = \angle \frac{a_{z_p}(j\omega_c)}{F_{es}(j\omega_c)} - (14.3 \text{ deg-sec/rad}) \omega_c$$

where a_{z_p} is normal acceleration at the pilot's station.

A related requirement in 4.2.8.2. Also, see 4.1.11.6 for a general PIO requirement. The qualitative requirement of MIL-F-8785C is generalized in view of uncertainties in the state-of-the-art of flight control system design, a tacit recognition of the complexity of the PIO problem; no detailed specification is, at this time, a guarantee against building a PIO-prone airframe/flight-control-system combination.

The requirement precludes PIO, PIO tendencies or general handling qualities deficiencies resulting from inadequate pilot-vehicle closed-loop gain and phase margins. PIO has occurred in the T-38A, A4D, and YF-12 due to abrupt amplitude-dependent changes in aircraft dynamic response to pilot control inputs. These effects can be of mechanical origin, e.g. bobweights coupled with static friction, or due to saturation of elements within the control system, or due to compensation added to the automatic control system. Other known sources are short-period dynamics (e.g. large $\omega_{SP} T_{\Theta_2}$), feel system phasing (e.g. effective bobweight location not far enough forward), and sensitive control force and motion gradients. AFFDL-TR-69-72 and Norair Rpt NOR-64-143 can furnish some insight.

The requirement above is popularly known as the Smith-Geddes PIO criteria. It was proposed in its original form in AFFDL-TR-77-57. It was more fully developed as a general longitudinal response requirement in AFFDL-TR-78-154, and further developed and extended to the lateral-directional axis in

**MIL-STD-1797A
APPENDIX A**

AFWAL-TR-81-3090. No specific method for determining \bar{S} was required in AFFDL-TR-78-154. Smith originally recommended a range of 2 to 6 rad/sec and computed \bar{S} as the average of three linear approximations of slopes between pairs of points one octave apart, i.e.:

$$\bar{S} = \frac{1}{3} \left[\left| \frac{\Theta}{F_{es}}(4j) \right| - \left| \frac{\Theta}{F_{es}}(2j) \right| + \left| \frac{\Theta}{F_{es}}(5j) \right| - \left| \frac{\Theta}{F_{es}}(2.5j) \right| + \left| \frac{\Theta}{F_{es}}(6j) \right| - \left| \frac{\Theta}{F_{es}}(3j) \right| \right]$$

In AFWAL-TR-81-30990 the frequency range was extended to 1 to 6 rad/sec, and a similar formula was used to compute \bar{S} using five slopes instead of three, i.e.:

$$\bar{S} = \frac{1}{3} \left[\left| \frac{\Theta}{F_{es}}(2j) \right| - \left| \frac{\Theta}{F_{es}}(1j) \right| + \left| \frac{\Theta}{F_{es}}(3j) \right| - \left| \frac{\Theta}{F_{es}}(1.5j) \right| + \left| \frac{\Theta}{F_{es}}(4j) \right| - \left| \frac{\Theta}{F_{es}}(2j) \right| + \left| \frac{\Theta}{F_{es}}(5j) \right| - \left| \frac{\Theta}{F_{es}}(2.5j) \right| + \left| \frac{\Theta}{F_{es}}(6j) \right| - \left| \frac{\Theta}{F_{es}}(3j) \right| \right]$$

This modification brought predictions of ω_c more in line with observations based on Landing Approach Higher Order System (LAHOS) data. AFFDL-TR-78-154 advises using a consistent method to calculate \bar{S} , even when the slope of

$\left| \frac{\Theta(s)}{F_{es}(s)} \right|$ varies considerably in the 1 to 6 rad/sec range.

The criterion frequency, ω_c , is an approximation of the crossover frequency of the pilot-vehicle system during pitch attitude tracking. This approximation is based on data from AFFDL-TR-65-15 shown on figure 276. This figure shows crossover frequency as a function of forcing function bandwidth for different controlled elements. The equation for ω_c was derived from this data as shown on figure 277, taken from AFFDL-TR-78-154. This equation was altered slightly in AFWAL-TR-81-3090 to the form recommended in Requirement Guidance. This modification was made in conjunction with the modifications in the calculation of \bar{S} to better fit the LAHOS data and F-15 CAS-off, supersonic PIO experiences.

The third parameter in this requirement, $\phi(\omega_c)$, is a phase parameter associated with the normal acceleration sensed at the pilot's station. It consists of the aircraft phase angle of normal acceleration frequency response plus a phase angle due to an assumed pilot response delay at the pitch attitude criterion frequency, ω_c . This parameter becomes important if there is too much phase lag in the pitch attitude response to stick force; thus the condition that this parameter be considered when the phase angle of the pitch attitude response to stick force is less than -160° . This is a fundamental element of the Smith-Geddes, originally derived in AFFDL-TR-77-57, and was included in its original form in MIL-F-8785C and MIL-STD-1797. In the original form, ϕ was evaluated at ω_R , where ω_R was defined as any frequency within the range of 1 to 10 rad/sec at which lightly damped (resonant) oscillations in pitch attitude could result from turbulence inputs or from piloted control of the aircraft when used in the intended manner. In AFFDL-TR-78-154, ω_R was replaced by ω_c as defined above. The concept behind this part of the requirement is that, if the pitch attitude (θ) loop is resonant at ω_c , then the pilot may attempt to control normal acceleration, a_{z_p} , instead of θ . The aircraft will be PIO prone if there is too much phase lag in this response. The criteria for this requirement are based largely on correlation with the Neal-Smith data base (AFFDL-TR-70-74).

The statement that requirements 4.2.1.2, 4.2.2, 4.2.8.1, 4.2.8.2. and 4.2.8.4 must also be met would seem to be redundant, since these are already requirements. However, recent history would seem to indicate that, because the term PIO does not appear in these requirements, the importance of these requirements in precluding PIO is not appreciated. Many recent PIO incidents can be traced directly to problems addressed by these requirements. Therefore, these requirements are repeated here in the PIO requirement to insure that their significance in precluding PIO tendencies is understood.

MIL-STD-1797A
APPENDIX A

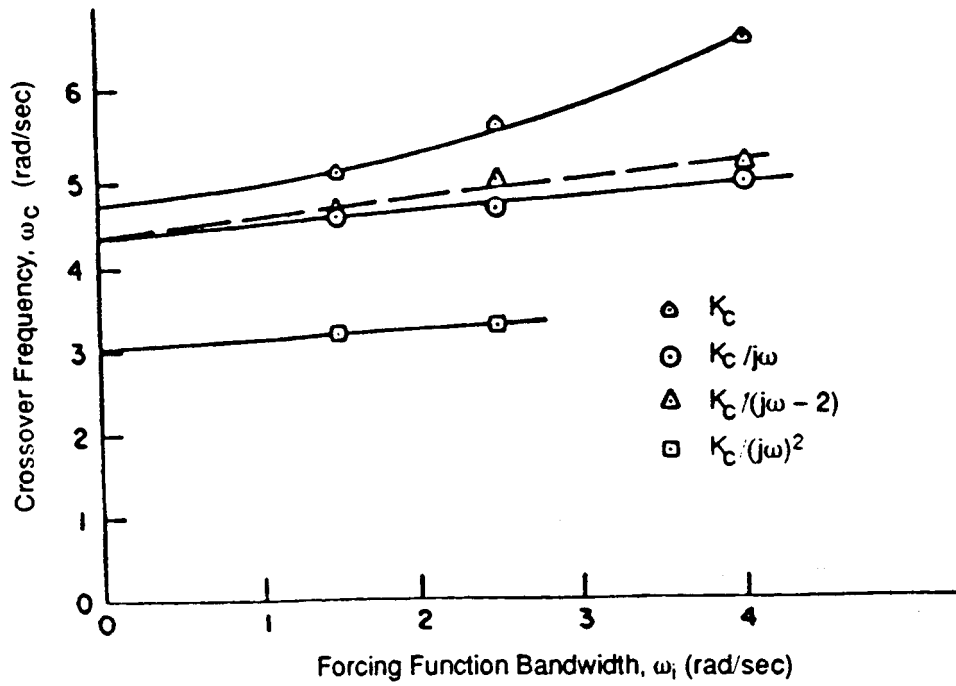

FIGURE 276. Variation of Crossover Frequency with Pitch Attitude Dynamics (from AFFDL-TR-65-15).

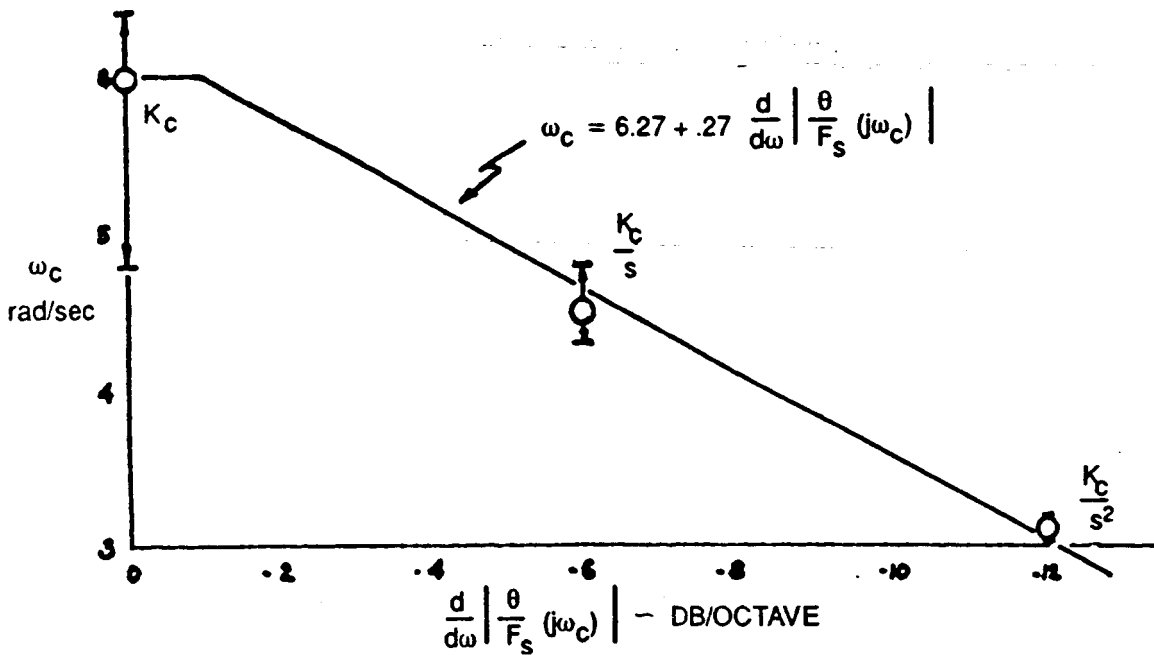

FIGURE 277. Specification of the Criterion Frequency.

MIL-STD-1797A APPENDIX A

Gibson's views of PIOs are taken directly from ICAS-86-5.3.4:

High order characteristics are associated with pilot-vehicle closed-loop handling problems or PIO. As this term has been used to describe low order problems, the differences should be clearly understood. The abrupt pitch bobble type is discontinuous, consisting of repeated tracking corrections. The sluggish pitch overdriving type is also discontinuous with input pulses to stop the unpredictable excess in response. Although the aircraft is not under complete control, it is not out of control.

High order PIO is a continuous out of control attitude instability, the amplitude ranging from small to large and potentially destructive. Because the problem is due to inadequate pilot-vehicle closed loop gain and phase margins, examination of the pitch attitude frequency response identifies the cause and the solution.

Figure [76] shows the features which separate low and high-order pitch handling. The area of interest can be confined to the region of phase lags between 180 and 200 degrees which determines the PIO frequency. This arises from the success of the synchronous pilot (NOR-64-143) in PIO analysis, assuming that any pre-PIO equalization is abandoned for a pure gain behavior in the undamped or divergent oscillation. The correct frequency is adopted instantaneously with the stick in phase with the pitch attitude error and 180 degrees out of phase with the attitude. The stick is not always moved so purely in practice, but very often the pilot can be seen to apply the stick a little too quickly and then hold it while waiting for the pitch rate reversal before also reversing the stick.

The tendency of a configuration to PIO can therefore be assessed without using a pilot model by empirically establishing the range of characteristics found in actual PIO examples. Enough have now been published to do this with considerable accuracy. An important feature at the PIO frequency is the response gain. If this is small enough, dangerous oscillation amplitudes cannot occur, and PIO has not been found where this is less than 0.1 degrees per pound of stick force. This is not a completely necessary condition but it is a highly desirable design aim.

PIO's have occurred most frequently, though not exclusively, in the landing flare. The connection with the commonplace stick pumping is well established. This subconscious excitation of pitch acceleration in the flare occurs near the same frequency as a PIO. If the attitude in the oscillation suddenly intrudes into the pilot's awareness, a ready-made PIO is already in existence. The lower the frequency, the larger is the attitude oscillation at the usual acceleration amplitude of about 6 deg/sec², and the more likely the conversion becomes. This indicates strongly the desirability of a high crossover frequency through the PIO region.

While an oscillation amplitude of less than 0.5-degrees in the flare will not usually be noticed, the one significantly more than a degree is very likely to, this or the corresponding pumping/PIO frequency is not an ideal parameter for correlation. The most successful has proved to be the rate at which the pitch attitude phase lag increases with frequency in the PIO lag crossover region, equally applicable to the landing or to target tracking tasks. By the nature of the attitude frequency response, if the crossover frequency is low and the attitude attenuates only slowly towards the crossover region, the phase rate is large. If the frequency is high and there is substantial attenuation, the phase rate is low. The gain margin is increased, the stick pumping amplitude is reduced, and the tendency to PIO is decreased automatically by designing a low phase rate into the control laws.

This simple attitude parameter alone is almost sufficient to quantify the tendency to high order PIO, and it correlates well with available examples of high order PIO. Figure [77] shows the trends, with an accuracy good enough to allow Level 1, 2, and 3 boundaries to be drawn, if desired. For the control law designer it is enough to aim for a phase rate of less than 100 degrees per cps and attitude response phase rate of less than 100 degrees per cps and attitude response smaller than 0.1 deg/lb at the crossover. These

MIL-STD-1797A APPENDIX A

characteristics are a natural feature of low order aircraft whose attitude phase lag exceeds 180 degrees due to the power control and so could in principle suffer from PIO, yet do not. Early examples of bobweight PIO were high-order in kind and are found to have had very large phase rates with the stick free.

For most combat aircraft configurations, consideration of normal acceleration effects does not improve the PIO analysis. The g at the cockpit is usually attenuated and phase advanced relative to the cg and will often not reach the 180 degrees lag necessary for piloted instability. Human sensing of the g response is poor and at the initiation of the PIO the g may be undetectable. In large aircraft with the cockpit far ahead of the cg, the heave can have a significant effect and has to be taken into account in the dominant requirement to optimize the pitch attitude behavior.

Although the attitude to stick force response gain is significant in PIO, there is little evidence that a damper modifies the pilot's stick phasing in a PIO and only the stiffness component should be used. Where PIO tendencies exist, they will be exacerbated by a high stick stiffness. Gradients of 5 to 8 lb/in with forces of 2 to 2.5 lb g have proved to be extremely satisfactory for [fly-by-wire] aircraft. Designed to the phase rate and gain margin criteria discussed above, the attitude gain phase rate and gain at the PIO frequency is only some 0.5 deg/in. In AFFDL-TR-74-9, case 4D had high phase rate and low PIO gain margin. With a gradient of 22 lb/in and 6.7 lb/g it had an attitude gain of 7 deg/in at the PIO frequency. Not surprisingly it suffered from continuous pitch oscillations and severe tracking PIO, earning ratings of 9 and 10.

The boundaries in the frequency response criteria of figure [75] are based directly on these considerations and will eliminate high order PIO. Low order PIO will also be eliminated by the optimization criteria given above.

REQUIREMENT LESSONS LEARNED

The Smith-Geddes criteria has been used by AFFTC with considerable success for several years. The criteria has been used to analyze PIOs in the Space Shuttle, the F-15 with CAS-off, the AFTI/F-16, the AFTI/F-111, the F-15 S/MTD, the YF-22, and the C-17. Application of the criteria to the Space Shuttle was documented in "Prediction and Occurrence of Pilot-Induced Oscillations in a Flight Test Aircraft" by Twisdale and Kirsten. In an analysis of three PIOs in the Space Shuttle, the Smith-Geddes criteria correctly predicted the PIO tendency and closely predicted the frequency of the PIO. For a PIO in landing flare, the criteria predicted a frequency of 3.5 rad/sec and the frequency of the observed PIO was 3.6 rad/sec. In another PIO at an altitude of 18,000 ft and a speed of 610 ft/sec, the criteria predicted a frequency of 3.3 rad/sec and the observed frequency was 3.1 rad/sec. In the final example, at a similar flight condition, a PIO occurred while tracking a cockpit display. When the display dynamics were added to the analysis, the criteria accurately predicted the observed PIO frequency of 2.0 rad/sec.

A valuable lesson learned in the determination of the criterion frequency, ω_c , is found in a Northrop white paper, "Evaluation of B-2 Susceptibility to Pilot-induced Oscillations" by Margo L. Givens and Frank L. George, presented at the Flying Qualities Working Group at the 1994 AIAA Atmospheric Flight Mechanics Conference.

For the most part, the approach taken was as recommended by Ralph Smith in [AFFDL-TR-78-154] which presented a straight forward process of evaluation. Exceptions were made for criterion frequency selection. The recommended method [in AFFDL-TR-78-154] for criterion frequency selection is based on calculating an average slope of the pitch attitude-to-controller Bode magnitude plot in the range of 2.0 to 6.0 rad/sec and then applying this value to the $[\omega_c]$ formula. This frequency range stipulation was often inappropriate for the B-2 which has higher break frequencies than those systems described in the [Smith-Geddes] documentation. Because the validity of a [Smith-Geddes] analysis is dependent on the correct selection of the criterion frequency, three other methods of criterion frequency selection were evaluated.

MIL-STD-1797A
APPENDIX A

The first method, which has been used by Ralph Smith in the past, involved selecting parameters for a pilot model, closing the pitch attitude loop, and obtaining an n_z to α_{gust} response power spectral density (PSD) in search of resonant frequencies which would be defined as the criterion frequencies. The implementation of this method was unproductive because no resonant frequencies were found in the B-2 n_z PSDs.

The second method adapted the recommended ω_c derivation formula to use the slope calculated after the short period break rather than the average slope in the 2.0 to 6.0 rad/sec frequency range. This method worked quite well for most of the cases. Because of the occasional case which produced questionable results, a third method of frequency determination was devised for use as a validity check on criterion frequencies derived using method 2.

The third approach used typical B-2 pilot pitch stick input frequencies as the criterion frequencies. These frequencies were determined by calculating PSDs from stick, n_z , and θ time histories of landings and refuelings extracted from flight test data. It was found that the ω_c values calculated with the second method were consistent with these flight data pilot stick input frequency ranges.

A very good summary report on PIOs is given in NOR-64-143. The following paragraphs from that reference discuss the causes of PIOs:

There are several ways of looking at the causes of a PIO. One is to catalog all the PIO situations ever recorded, including all the necessary subsystem details, etc., and then to say that each combination of vehicle and subsystem when combined with the pilot was the cause of a PIO. Another way is to note that certain system phenomena such as stick-force-to-control-deflection hysteresis often lead to PIO when other conditions are right. A third way, and one which seems to transcend the difficulties of the previous two, is to say that certain inherent human physical limitations are the basic cause for any PIO. This is not to degrade the human pilot's role but, instead, to emphasize it, because it is unlikely that any black-box could be devised which is as clever and effective in coping with unmanageable controlled elements as a skilled pilot. Were it not for the pilot's versatile gain adaptability, many flight conditions would be unstable. But there is a limit to the rapidity with which the human can adapt, and this can sometimes lead to a PIO.

When referred to the pilot, then, the basic causes of PIO seem to fall into the following categories:

1. Incomplete pilot equalization
 - a. Incomplete training
 - b. Inappropriate transfer of adaptation (i.e., carry over of improper techniques from another aircraft)
2. Excessive-demands on pilot adaptation
 - a. Required gain, lead, or lag lie outside the range of normal capabilities
 - b. Rate of adaptation is too slow to preclude oscillation
 - c. Inadequate capability to cope with system nonlinearities
3. Limb-manipulator coupling
 - a. Impedance of neuromuscular system (including limb) on control stick or pedals changes feel system dynamics

MIL-STD-1797A
APPENDIX A

- b. Motion-induced limb force feedback (e.g., arm becomes a bobweight)

Table XIV, from NOR-64-143, lists some known PIO cases and their probable causes for then-current (early 1960s) aircraft. The causes are equally relevant for modern aircraft, and the lessons learned from the cases listed are valuable in preventing PIOs.

5.2.2 Pilot-in-the-loop oscillations - verification.

Verification shall be by analysis, simulation, and flight test.

VERIFICATION RATIONALE (5.2.2)

It would be an easy matter for the engineers of the procuring agency to ascertain compliance with this paragraph without relying on pilot/vehicle analysis methods. For example, ω_c and the specified phase lag can easily be obtained from simulator or in-flight time histories (ground-based simulations will not show up acceleration-dependent PIO tendencies). Nonetheless, analytical estimates can - and should - be made by the airframe manufacturer as part of the design evolution. For flight evaluation, the PIO tendency classification scale of figure 12 will be helpful.

VERIFICATION GUIDANCE

The user should refer to AFFDL-TR-77-57, AFFDL-TR-78-154, and AFWAL-TR-81-3090 when applying the quantitative requirement. PIOs are associated with abrupt maneuvers and precise tracking as in air-to-air gunnery, formation flying, flare, and touchdown. PIOs observed in flight are often not obtained in ground-based simulators, even ones with some motion. Tight, aggressive pilot control action will tend to bring on any PIO tendencies. High sensitivity to control inputs is often a factor. Some pilots are more PIO-prone than others, depending upon piloting technique.

VERIFICATION LESSONS LEARNED

These requirements are an attempt to catch and correct any PIO tendencies as early as possible in the design, when changes are easiest and least costly to make. They also have been found helpful in identifying PIO tendencies in flight and determining fixes.

**MIL-STD-1797A
APPENDIX A**

TABLE XIV. Classification of some known PIO cases (from NOR-64-143).

Examples shown as: SPECIES (Aircraft); Critical Subsystem; Critical Flight Condition: Remarks

CLASS	TYPE		
	I. LINEAR	II. SERIES NONLINEAR ELEMENTS	III. SUBSIDIARY FEEDBACK NONLINEAR ELEMENTS
PITCH	<p><u>IMPROPER SIMULATION</u>; D, V; a: Abnormally high value of $1/T_{\theta 2}$ and low $\zeta_{\omega_{sp}}$ led to zero ζ_{sp} when regulating large disturbances.</p> <p><u>GCA-INDUCED PHUGOID (C-97)</u>; D; c, b: Lag from radar-detected error to voice command led to unstable closed-loop phugoid mode.</p> <p><u>ARM ON STICK (A4D-1, T-38A)</u>; F; a: Arm mass increases feel system inertia, leads via B feedback to unstable coupling with short-period dynamics if pilot merely hangs loosely onto stick after a large input.</p>	<p><u>PORPOISING (SB2C-1)</u>; F; c: Hysteresis in stick versus elevator deflection resulted in low-frequency speed and climb oscillations.</p> <p><u>J. C. MANEUVER (F-86D, F-100C)</u>; F, S; a: Valve friction plus compliant cabling resulted in large oscillations at short period.</p> <p><u>PITCH-UP (XF-104, F-101B, F-102A)</u>; V; c: Unstable kink in $M(\alpha)$ curve led to moderate-period oscillations of varying amplitudes (depending on extent and nature of the kink) during maneuvers near the critical angle-of-attack.</p> <p><u>LANDING PIO (X-15)</u>; S; b: Closed loop around elevator rate-limiting caused moderate oscillations at short period.</p>	<p><u>BOBWEIGHT BREAKOUT (A4D-1, T-38A)</u>; F, B; a: At high-g maneuvers the bobweight overcomes system friction and reduces apparent damping of the aircraft in response to force inputs, resulting in large oscillations at short-period.</p> <p><u>LOSS OF PITCH DAMPER</u></p>
LATERAL-DIRECTIONAL	<p><u>ω_{ϕ}/ω_d EFFECT (X-15, NT-33A, F-101B, F-106A, KC-135A, B-58)</u>; V; c: Zeros of roll/aileron transfer function are higher than Dutch roll frequency, $\omega_{\phi} / \omega_d > 1.0$, leading to closed-loop instability at low ζ_d conditions.</p> <p><u>BORESIGHT OSCILLATIONS (F-5A)</u>; D, V; c: Spiral roll mode driven unstable if roll information is degraded during gunnery.</p>		<p><u>LOSS OF YAW DAMPER</u></p>
YAW	<p><u>FUEL SLOSH SNAKING (KC-135A, T-37A)</u>; V; c: Fuel slosh mode couples with Dutch roll mode when rudder used to stop yaw oscillation.</p>	<p><u>TRANSONIC SNEAKING (A3D)</u>; V, F; a, c: Separation over rudder causes control reversal for small deflections, leading to limit cycle if rudder used to damp yaw oscillations.</p>	
ROLL	<p>NONE KNOWN</p>	<p><u>PILOT-INDUCED CHATTER (F-104B)</u>; A; c: Small limit cycle due to damper aggravated whenever pilot attempted to control it.</p>	

* Critical Subsystems:

D = Display

F = Feel system (except B)

B = Bobweight

S = Power servo actuator

V = Vehicle (airframe)

A = Augmentor (damper)

** Critical Flight Conditions:

a = Low altitude, near-sonic Mach

b = Landing approach and takeoff

c = Cruise

MIL-STD-1797A
APPENDIX A

4.2.3 Residual pitch oscillations.

In calm air, any sustained residual oscillations shall not interfere with the pilot's ability to perform the tasks required in service use of the aircraft. For Levels 1 and 2, oscillations in normal acceleration at the pilot station greater than will be considered excessive for any Flight Phase. These requirements shall apply with the pitch control fixed and with it free.

REQUIREMENT RATIONALE (4.2.3)

The requirement prohibits limit cycles in the control system or structural oscillations that might compromise tactical effectiveness, cause pilot discomfort, etc. This requirement may be considered a relaxation of the requirement in 4.2.1 for positive damping at all magnitudes of oscillation. Its intent is to recognize thresholds below which damping is immaterial.

REQUIREMENT GUIDANCE

The related MIL-F-4785C requirement is paragraph 3.2.2.1.3.

The recommended value is 0.02g. Given the proper data, this threshold could be made a function of frequency in order to correspond more closely with human perception.

REQUIREMENT LESSONS LEARNED

Allowable normal acceleration oscillations have been decreased to 0.02g from the 0.05g of MIL-F-8785C. This is based on flight test experience with the B-1 (AFFTC-TR-79-2), which encountered limit cycle oscillations during aerial refueling, subsonic and supersonic cruise. A primary contributor was identified to be mechanical hysteresis in the pitch system. According to AFFTC-TR-79-2, "Flying qualities were initially undesirable due to this limit cycle." Normal acceleration transients in cruise were about 0.05-0.12 g, as figure 94 shows. The limit cycle was eliminated by installation of a mechanical shaker (dither) vibrating at 20 Hz.

5.2.3 Residual pitch oscillations - verification.

Verification shall be by analysis, simulation and flight test.

VERIFICATION RATIONALE (5.2.3)

Limit cycle amplitude depends on characteristics of the actual hardware and software, and so may be different in simulations than in actual flight. Measurements of normal acceleration at the pilot's station should be made in the course of test flight to meet the other flying quality requirements.

VERIFICATION GUIDANCE

Residual oscillations are limit cycles resulting from nonlinearities such as friction and poor resolution. Negative static stability will contribute and low damping may augment the amplitude. Thus high speed, high dynamic pressure or high attitude may be critical. Residual oscillations are most bothersome in precision tasks.

VERIFICATION LESSONS LEARNED

MIL-STD-1797A
APPENDIX A

4.2.5 Pitch trim changes.

The pitch trim changes caused by operation of other control devices shall not be so large that a peak pitch control force in excess of 10 pounds for center-stick controllers or 20 pounds for wheel controllers is required when such configuration changes are made in flight under conditions representative of operational procedure. Generally, the conditions of table IV will suffice for determination of compliance with this requirement. With the aircraft trimmed for each specified initial condition, and no retrimming, the peak force required to maintain the specified parameter constant following the specified configuration change shall not exceed the stated value for a time interval of at least 5 seconds following the completion of the pilot action initialing the configuration change. The magnitude and rate of trim change subsequent to this time period shall be easily trimmable by use of the normal trimming devices. These requirements define Level 1. For Levels 2 and 3, the allowable forces are increased by 50 percent. _____

REQUIREMENT RATIONALE (4.2.5)

These frequently encountered pitch trim changes, if too large, can add to pilot workload at critical times during a mission.

REQUIREMENT GUIDANCE

The related MIL-F-8785C paragraph is 3.6.3.1.

Table XV gives the recommended conditions (For aircraft with variable-sweep wings, additional requirements should be imposed consistent with operational employment of the vehicle. Thrust reversing and other special features also need to be considered). These are the trim changes that, when larger than the limits specified, have been bothersome in the past. Crossfeeds and feedbacks in the stability and control augmentation system generally will reduce the magnitude of these trim changes. Wing downwash and vertical placement of the engines are two of the determining factors. For thrust reversing, configuration-dependent aerodynamics play an important role.

4.1.13 gives additional general trim requirements.

REQUIREMENT LESSONS LEARNED

The direction of the trim change can also be important, producing either helpful or unfavorable coupling. In any case the magnitude should not be excessive.

5.2.5 Pitch trim changes - verification.

Verification shall be by analysis, simulation and flight test.

VERIFICATION RATIONALE (5.2.5)

The evaluation should be made in the manner expected in operational practice, rather than necessarily holding everything else constant.

VERIFICATION GUIDANCE

Initial trim conditions are listed in table XV.

VERIFICATION LESSONS LEARNED

**MIL-STD-1797A
APPENDIX A**

TABLE XV. Pitch trim change conditions.

	Flight Phase	Initial Trim Conditions					Configuration Change	Parameter to be held constant
		Attitude	Speed	Landing Gear	High-lift Devices & Wing Flaps	Thrust		
1	Approach	$h_{o_{min}}$	Normal pattern entry speed	Up	Up	TLF	Gear down	Altitude and airspeed*
2				Up	Up	TLF	Gear down	Altitude
3				Down	Up	TLF	Extend high-lift devices and wing flaps	Altitude and airspeed*
4			↓	Down	Up	TLF	Extend high-lift devices and wing flaps	Altitude
5				Down	Down	TLF	Idle thrust	Airspeed
6	↓		$V_{o_{min}}$ ↓	Down	Down	TLF	Extend approach drag device	Airspeed
7				Down	Down	TLF	Takeoff thrust	Airspeed
8	Approach	↓	$V_{o_{min}}$ ↓	Down	Down	TLF	Takeoff thrust plus normal cleanup for wave-off (go-around)	Airspeed
9	Takeoff		↓	Down	Take-off	Take-off thrust	Gear up	Pitch attitude
10	↓		Minimum flap-retract speed	Up	Take-off	Take-off thrust	Retract high-lift devices and wing flaps	Airspeed
11	Cruise and air-to-air combat	$h_{o_{min}}$ and $h_{o_{max}}$	Speed for level flight	Up	Up	MRT	Idle thrust	Pitch attitude
12				Up	Up	MRT	Actuate deceleration devices	
13				Up	Up	MRT	Maximum augmented thrust	↓
14	↓	↓	Speed for best range	Up	Up	TLF	Actuate deceleration device	

*Throttle setting may be changed during the maneuver.

Notes: - Auxiliary drag devices are initially retracted, and all details of configuration not specifically mentioned are normal for the Flight Phase.

MIL-STD-1797A
APPENDIX A

- If power reduction is permitted in meeting the deceleration requirements established for the mission, actuation of the deceleration device in #12 and #14 shall be accompanied by the allowable power reduction.

MIL-STD-1797A
APPENDIX A

5.5.1.5 Time delay - verification.

Verification shall be by analysis, simulation and flight test.

VERIFICATION RATIONALE (5.5.1.5)

In the end, flight test data or a flight-verified analytical model should be used to verify compliance.

A control surface rate limit may increase the equivalent time delay or roll-mode time constant as a function of the size of command.

VERIFICATION GUIDANCE

Appropriate values of τ_{ep} will require equivalent system matching, as discussed above. See guidance for 4.5.1.1.

VERIFICATION LESSONS LEARNED

MIL-STD-1797A APPENDIX A

4.5.2 Pilot-in-the-loop roll oscillations.

There shall be no tendency for sustained or uncontrollable roll oscillations resulting from efforts of the pilot to control the aircraft. The phase angle of the bank angle frequency response to roll stick force at the criterion frequency, ω_c , shall be greater than or equal to _____. Furthermore, the requirements of 4.5.1.1, 4.5.1.3, 4.5.1.4, 4.5.1.5, 4.5.8.1, 4.5.9.2, and 4.5.9.3 must be met.

REQUIREMENT RATIONALE (4.5.2)

This roll-axis requirement is stated in addition to the general requirement of 4.1.11.6 to emphasize its importance for the roll axis and to allow incorporation of a more quantitative requirement.

REQUIREMENT GUIDANCE

The related MIL-F-8785C requirement is paragraph 3.3.3.

Recommended values:

The recommended minimum phase angle of the bank angle frequency response to the roll stick force at the criterion frequency, ω_c , is -180° .

The value of ω_c is determined as follows:

$$\omega_c = (0.24 \text{ rad-oct/dB-sec}) \bar{S} + 6.0 \text{ rad/sec}$$

where \bar{S} is the average slope of $\left| \frac{\phi(s)}{F_{as}(s)} \right|$ in dB/oct over the interval from 1 to 6 rad/sec.

This requirement is the Smith-Geddes PIO criteria extended to the lateral-directional axis. The origins of the Smith-Geddes criteria are traced in 4.2.2 Requirement Guidance, and discussions of the calculation of \bar{S} and ω_c can be found there. Application in the lateral-directional axis is similar to that in the longitudinal axis, except that it is applied to ϕ/F_{as} instead of to θ/F_{es} .

The statement that requirements 4.5.1.1, 4.5.1.3, 4.5.1.4, 4.5.1.5, 4.5.8.1, 4.5.9.2, and 4.5.9.3 must also be met would seem to be redundant, since these are already requirements. However, recent history would seem to indicate that, because the term PIO does not appear in these requirements, the importance of these requirements; in precluding PIO is not appreciated. Many recent PIO incidents can be traced directly to problems addressed by these requirements. Therefore, these requirements are repeated here in the PIO requirement to insure that their significance in precluding PIO tendencies is understood.

REQUIREMENT LESSONS LEARNED

The extension of the Smith-Geddes criteria to the lateral-directional axis was developed in AFWAL-TR-81-3090. In AFWAL-TR-81-3090, the lateral-directional criteria was used to analyze the YF-16, the X-15, and the M2-F2 and M2-F3 lifting bodies and also compared with results from handling qualities research projects with variable-stability aircraft: an approach and landing evaluation with the NT-33 (AFWAL-TR-81-3116), an investigation of reentry vehicle lateral-directional dynamics on the NT-33 (WADD-TR-61-147), and one configuration from lateral-directional studies on the Princeton Navion (Princeton University Report No. 727). Most of the data support the PIO criteria, and, in those cases where PIO was predicted but not encountered, handling qualities were usually poor.

See 4.2.2 for discussion of applicable considerations and data, in that case directed at longitudinal PIOs in general. The M2-F2 lifting body (NASA-TN-D-6496) encountered several divergent PIOs during flight testing. The primary cause was found to be the coupled roll subsidence/spiral mode (see Lessons Learned for 4.5.1.3).

MIL-STD-1797A
APPENDIX A

Another cause of observed lateral PIO tendencies is the ω_ϕ / ω_d effect noted and explained in figure 158 and also in Norair Rpt No. NOR-64-143. Another prevalent cause is associated with control-surface rate saturation. In this case the pilot tries to apply lateral control at a rate greater than the maximum surface rate, thereby getting out of phase if tight tracking is attempted. The quantitative aspects of such rate-limiting are given in the appendix of Norair Rpt No. NOR-64-143 and involve gain and phase decrements that are functions of the ratio of commanded to saturation rate.

PIOs on recent aircraft have been related to roll responses which are both too low (F-18) and too high (YF-16). These cases are discussed under 4.5.8.1 and 4.5.9.3. Control sensitivity, control surface rate limiting, control surface saturation, and (equivalent) time delay are critical factors in roll PIO.

5.5.2 Pilot-in-the-loop roll oscillations - verification.

Verification shall be by analysis, simulation and flight test.

VERIFICATION RATIONALE (5.5.2)

This requirement should apply to all flight conditions and tasks, and to all Levels, since zero or negative closed-loop damping is to be avoided under all flight conditions and failure states.

VERIFICATION GUIDANCE

The existence of a PIO tendency is difficult to assess. A high-stress task such as approach and landing with a lateral offset, air-to-air tracking, or terrain following, may reveal PIO proneness. Demanding tracking tasks, aggressive control, sensitive response, proverse yaw, low dutch roll damping and long equivalent time delay are factors varying with flight condition which may tend to incite roll PIOs. Lateral acceleration induced on the pilot in rolling may contribute.

VERIFICATION LESSONS LEARNED

In a number of cases optimization of p/F_{as} in a fixed-base simulator has resulted in gross oversensitivity in actual flight.

MIL-STD-1797A
APPENDIX A

2. Multiply the result by $N'_{\delta_{rp}}/L'_{\delta_{as}}$, i.e., $\delta'_{rp}(3) = Y_{CF}(3) \cdot N'_{\delta_{rp}}/L'_{\delta_{as}}$
3. Compare $\delta'_{rp}(3)$ with table XLIV
7. If $0.03 < |N'_{\delta_{as}}/L'_{\delta_{as}}| \leq 0.07$, utilize the more conservative result from steps 5 and 6.
8. If the configuration does not meet the requirements, see figure 249 and table XLVII to determine the type of expected piloting problems.
9. In the end, the transfer functions should be identified from flight data.

VERIFICATION GUIDANCE

The flight testing to obtain $\Delta\beta$ and $\phi_{t \text{ command}}$ should cover the range of operational altitudes and service speeds. As with roll rate oscillations (4.5.1.4), the critical flight conditions for compliance with this requirement should in general become apparent during the roll performance testing of 4.5.5.1. The most important flight conditions for compliance demonstration of either alternative are those with low $|\phi/\beta|_d$ less than 6.

An approximation for $|\phi/\beta|_d$ is

$$\left| \frac{\phi}{\beta} \right|_d \approx \left[\frac{(L'_\beta + Y_\beta L'_r)^2 + 2\zeta_d \omega_d L'_r (L'_\beta + Y_\beta L'_r) + \omega_d^2 L_r'^2}{\omega_d^2 [L_p'^2 + 2\zeta_d \omega_d L'_p + \omega_d^2]} \right]^{1/2} \approx$$

$$\frac{k_z^2 C'_{\ell_\beta}}{k_x^2 C'_{n_p}} \left[\frac{1 - \frac{\rho g b}{4(W/S)} \left[C_{y_\beta} + \frac{1}{2k_z^2} C'_{n_r} - \frac{k_z^2}{k_x^2} \frac{C'_{\ell_\beta}}{C'_{n_\beta}} \left(C_{L_1} - \frac{1}{2k_z^2} C'_{n_p} \right) \right] \frac{C'_{\ell_r}}{C'_{\ell_\beta}} + \frac{\rho g b}{8(W/S) k_z^2} \left(\frac{C'_{\ell_r}}{C'_{\ell_\beta}} \right)^2 C'_{n_\beta}}{1 - \frac{\rho g b}{4(W/S) k_x^2} \left[C_{y_\beta} + \frac{1}{2k_z^2} C'_{n_r} - \frac{k_z^2}{k_x^2} \frac{C'_{\ell_\beta}}{C'_{n_\beta}} \left(C_{L_1} - \frac{1}{2k_z^2} C'_{n_p} \right) \right] \frac{C'_{\ell_p}}{C'_{n_\beta}} + \frac{\rho g b}{8(W/S) k_x^2} \frac{C'_{\ell_p}}{C'_{n_\beta}}}} \right]^{1/2}$$

VERIFICATION LESSONS LEARNED

MIL-STD-1797A
APPENDIX A

4.6.3 Pilot-in-the-loop yaw oscillations.

There shall be no tendency for sustained or uncontrollable yaw oscillations resulting from efforts of the pilot to control the aircraft in the air or on the ground. Furthermore, the requirements of 4.6.2 must be met.

REQUIREMENT RATIONALE (4.6.3)

This requirement, in addition to the general requirement of 4.1.11.6, is inserted to provide more specific criteria for any task that might involve high-bandwidth control in yaw or lateral acceleration. An example might be yaw pointing for fine tracking.

REQUIREMENT GUIDANCE

The related MIL-F-8785C requirement is paragraph 3.3.3.

The statement that requirement 4.6.2 must also be met would seem to be redundant, since this is already a requirement. However, as with the corresponding requirements in the pitch and roll axes, because the term PIO does not appear in requirement 4.6.2, the importance of this requirement in precluding PIO may not be appreciated. Therefore, requirement 4.6.2 is repeated here in the PIO requirement to insure that its significance in precluding PIO tendencies is understood.

Due to the lack of a reliable quantitative measure, the requirement is written in terms of subjective evaluations. It is of course hoped that meeting the (other) quantitative requirements of this standard will prevent a lateral PIO. This requirement is identical to the roll-axis requirement of 4.5.2.

This requirement should apply to all flight conditions and tasks, and to all Levels, since zero or negative closed-loop damping is to be avoided under any flight condition or failure state. High-bandwidth yaw-control tasks are uncommon. The dynamic yaw response requirement (4.6.2.1) is designed to account for the need of rudder pedal in rolling, but may not cover all contingencies. Some direct sideforce modes may involve high-bandwidth yaw control; see AFWAL-TR-81-3027 and Sammonds, et al., for example.

REQUIREMENT LESSONS LEARNED

The pitch-axis PIO requirement, 4.2.2, discusses some causes of PIOs. Factors known to contribute to lateral-directional PIOs are large effective or equivalent time delays, excessive friction or hysteresis in the flight control system, and the " ω_ϕ / ω_d " effect described at length in AFFDL-TR-69-72 (See 4.5.1.4 discussion). Depending upon the cause, ground-based simulation may or may not prove a useful investigation technique - often it does not.

5.6.3 Pilot-in-the-loop yaw oscillations - verification.

Verification shall be by analysis, simulation and flight test.

VERIFICATION RATIONALE (5.6.3)

A precision closed-loop task, performed aggressively, is needed.

VERIFICATION GUIDANCE

The existence of a PIO tendency is difficult to assess. Therefore, no specific flight conditions or tasks are recommended, though a high-stress task such as approach and landing with a lateral offset, terrain following, air-to-ground tracking, or in-flight refueling (receiver) may reveal PIO proneness.

VERIFICATION LESSONS LEARNED

INCH-POUND

MIL-STD-1797A
30 January 1990
SUPERSEDING
MIL-STD-1797(USAF)
31 March 1987

MILITARY STANDARD



FLYING QUALITIES OF PILOTED AIRCRAFT

AMSC N/A

FSC 15GP

DISTRIBUTION STATEMENT D. Distribution authorized to the Department of Defense and DoD contractors only; contains critical technology; (3 February 1986). Other requests shall be referred to ASD/ENES, Wright-Patterson AFB OH 45433-6503.

MIL-STD-1797A

DEPARTMENT OF DEFENSE

WASHINGTON DC 20402

Flying Qualities of Piloted Aircraft

1. This military standard is approved for use by all Departments and Agencies of the Department of Defense.
2. Beneficial comments (recommendations, additions, deletions) and any pertinent data which may be of use in improving this document should be addressed to: ASD/ENES, Wright-Patterson AFB, OH 45433-6503, by using the self-addressed Standardization Document Improvement Proposal (DD Form 1426) appearing at the end of this document or by letter.

W A R N I N G

INFORMATION SUBJECT TO EXPORT CONTROL LAWS

This document contains information subject to the International Traffic in Arms Regulation (ITAR) and/or the Export Administration Regulation (EAR) of 1979 which may not be exported, released, or disclosed to foreign nationals inside or outside the United States without first obtaining an export license. A violation of the ITAR or EAR may be subject to penalty of up to 10 years imprisonment and a fine of \$100,000 under 22 U.S.C. or Section 2410 of the Export Administration Act of 1979. Include this notice with any reproduced portion of this document.

DESTRUCTION NOTICE. For classified documents, follow the procedures in DoD 5220.22-M Industrial Security Manual, Section 11-19 or DoD 5200.1-R, Information Security Program Regulation, Chapter IX. For unclassified, limited documents, destroy by any method that will prevent disclosure of contents or reconstruction of the document.

MIL-STD-1797A

FOREWORD

This standard is intended for use with fixed-wing aircraft supported primarily by aerodynamic force rather than engine thrust. It also covers the handling characteristics of aircraft under piloted control on the ground, and may be used with powered-lift aircraft in aerodynamic flight (above the conversion speed, V_{con}). This standard also applies to piloted transatmospheric flight when flight depends upon aerodynamic lift and/or air breathing propulsion systems. Flying qualities of military rotorcraft are specified in MIL-H-8501, while flying qualities in V/STOL flight are the subject of MIL-F-83300.

For further background information, see Appendix C.

MIL-STD-1797A

CONTENTS

Paragraph		Page
1.	SCOPE	1
1.1	Purpose.....	1
1.2	Applicability.....	1
2.	APPLICABLE DOCUMENTS	1
2.1	Government documents.....	1
2.1.1	Specifications, standards, and handbooks.....	1
2.1.2	Other Government documents, drawings, and publications.....	1
2.2	Non-Government publications.....	1
2.3	Order of precedence.....	1
3.	DEFINITIONS.....	2
3.1	Aircraft classification and operational missions.....	2
3.2	Flight Phase Categories.....	2
3.3	Levels and qualitative suitability of flying qualities.....	2
3.4	Parameters.....	2
3.4.1	General terms.....	2
3.4.2	Speeds.....	3
3.4.3	Thrust and power.....	5
3.4.4	Control parameters.....	6
3.4.5	Longitudinal parameters.....	6
3.4.6	Lateral-directional parameters.....	8
3.4.7	Atmospheric disturbance parameters.....	16
3.5	Terms used in high angle of attack requirements.....	18
4.	REQUIREMENTS	19
4.1	General requirements.....	19
4.1.1	Loadings.....	19
4.1.2	Moments and products of inertia.....	19
4.1.3	Internal and external stores.....	19
4.1.4	Flight Envelopes.....	19
4.1.4.1	Operational Flight Envelopes.....	19
4.1.4.2	Service Flight Envelopes.....	19
4.1.4.3	Permissible Flight Envelopes.....	19
4.1.5	Configurations and States of the aircraft.....	19
4.1.6	Aircraft Normal States.....	21
4.1.6.1	Allowable Levels for Aircraft Normal States.....	21
4.1.6.2	Flight outside the Service Flight Envelopes.....	21
4.1.6.3	Ground operation.....	21
4.1.7	Aircraft Failure States.....	21
4.1.7.1	Allowable Levels for Aircraft Failure States.....	21
4.1.7.2	Aircraft Special Failure States.....	21
4.1.7.3	Probability calculation.....	21
4.1.7.4	Generic failure analysis.....	23
4.1.7.5	When Levels are not specified.....	23
4.1.7.6	Failures outside the Service Flight Envelopes.....	23
4.1.8	Dangerous flight conditions.....	23
4.1.8.1	Warning and indication.....	23
4.1.8.2	Devices for indication, warning, prevention, and recovery.....	24
4.1.9	Interpretation of subjective requirements.....	24
4.1.10	Interpretation of quantitative requirements.....	24
4.1.11	General flying qualities requirements.....	24
4.1.11.1	Buffet.....	24

MIL-STD-1797A

CONTENTS

Paragraph		Page
4.1.11.2	Release of stores.....	24
4.1.11.3	Effects of armament delivery and special equipment.....	24
4.1.11.4	Failures.....	24
4.1.11.5	Control margin.....	25
4.1.11.6	Pilot-induced oscillations (PIO).....	25
4.1.11.7	Residual oscillations.....	25
4.1.11.8	Control cross-coupling.....	25
4.1.12	General flight control system characteristics.....	25
4.1.12.1	Control centering and breakout forces.....	25
4.1.12.2	Cockpit control free play.....	26
4.1.12.3	Adjustable controls.....	26
4.1.12.4	Rate of control displacement.....	26
4.1.12.5	Dynamic characteristics.....	26
4.1.12.6	Damping.....	26
4.1.12.7	Transfer to alternate control modes.....	26
4.1.12.8	Flight control system failures.....	26
4.1.12.9	Augmentation systems.....	26
4.1.12.10	Auxiliary dive recovery devices.....	27
4.1.12.11	Direct force controllers.....	27
4.1.13	General trim requirements.....	27
4.1.13.1	Trim system irreversibility.....	27
4.1.13.2	Rate of trim operation.....	27
4.1.13.3	Stalling of trim systems.....	27
4.1.13.4	Transients and trim changes.....	27
4.1.13.5	Trim for asymmetric thrust.....	28
4.1.13.6	Automatic trim system.....	28
4.2	Flying qualities requirements for the pitch axis.....	28
4.2.1	Pitch attitude dynamic response to pitch controller.....	28
4.2.1.1	Long-term pitch response.....	28
4.2.1.2	Short-term pitch response.....	28
4.2.2	Pilot-induced pitch oscillations.....	28
4.2.3	Residual pitch oscillations.....	28
4.2.4	Normal acceleration at pilot station.....	28
4.2.5	Pitch trim changes.....	28
4.2.6	Pitch axis response to other inputs.....	29
4.2.6.1	Pitch axis response to failures, controls free.....	29
4.2.6.2	Pitch axis response to configuration or control mode change.....	29
4.2.7	Pitch axis control power.....	31
4.2.7.1	Pitch axis control power in unaccelerated flight.....	31
4.2.7.2	Pitch axis control power in maneuvering flight.....	31
4.2.7.2.1	Load factor response.....	31
4.2.7.3	Pitch axis control power in takeoff.....	31
4.2.7.4	Pitch axis control power in landing.....	31
4.2.8	Pitch axis control forces.....	31
4.2.8.1	Pitch axis control forces--steady-state control force per g.....	31
4.2.8.2	Pitch axis control forces--transient control force per g.....	31
4.2.8.3	Pitch axis control forces--control force variations during rapid speed changes.....	32
4.2.8.4	Pitch axis control forces--control force vs. control deflection.....	32
4.2.8.5	Pitch axis control breakout forces.....	32
4.2.8.6	Pitch axis control force limits.....	32
4.2.8.6.1	Pitch axis control force limits--takeoff.....	32
4.2.8.6.2	Pitch axis control force limits--landing.....	32
4.2.8.6.3	Pitch axis control force limits--dives.....	32

MIL-STD-1797A

CONTENTS

Paragraph		Page
4.2.8.6.4	Pitch axis control force limits-sideslips.....	32
4.2.8.6.5	Pitch axis control force limits-failures.....	33
4.2.8.6.6	Pitch axis control force limits-control mode change.....	33
4.2.8.7	Pitch axis trim systems.....	33
4.2.9	Pitch axis control displacements.....	33
4.2.9.1	Pitch axis control displacements-takeoff.....	33
4.2.9.2	Pitch axis control displacements-maneuvering.....	33
4.3	Flying qualities requirements for the normal (flight path) axis.....	33
4.3.1	Flight path response to attitude change.....	33
4.3.1.1	Transient flight path response to attitude change.....	33
4.3.1.2	Steady-state flight path response to attitude change.....	33
4.3.2	Flight path response to designated flight path controller.....	34
4.3.3	Flight path control power.....	34
4.3.3.1	Control power for designated primary flight path controller.....	34
4.3.3.2	Control power for designated secondary flight path controller.....	34
4.3.4	Flight path controller characteristics.....	34
4.4	Flying qualities requirements for the longitudinal (speed) axis.....	34
4.4.1	Speed response to attitude changes.....	34
4.4.1.1	Speed response to attitude changes-relaxation in transonic flight.....	34
4.5	Flying qualities requirements for the roll axis.....	34
4.5.1	Roll response to roll controller.....	34
4.5.1.1	Roll mode.....	34
4.5.1.2	Spiral stability.....	34
4.5.1.3	Coupled roll-spiral oscillation.....	34
4.5.1.4	Roll oscillations.....	35
4.5.1.5	Roll time delay.....	35
4.5.2	Pilot-induced roll oscillations.....	35
4.5.3	Linearity of roll response to roll controller.....	35
4.5.4	Lateral acceleration at the pilot station.....	35
4.5.5	Roll characteristics in steady sideslip.....	35
4.5.6	Roll axis control for takeoff and landing in crosswinds.....	35
4.5.7	Roll axis response to other inputs.....	35
4.5.7.1	Roll axis response to augmentation failures.....	35
4.5.7.2	Roll axis response to configuration or control mode change.....	35
4.5.8	Roll axis control power.....	36
4.5.8.1	Roll axis response to roll control inputs.....	36
4.5.8.2	Roll axis control power in steady sideslips.....	36
4.5.8.3	Roll axis control power in crosswinds.....	36
4.5.8.4	Roll axis control power for asymmetric thrust.....	36
4.5.8.5	Roll axis control power in dives and pullouts.....	36
4.5.8.6	Roll axis control power for asymmetric loading.....	36
4.5.9	Roll axis control forces and displacements.....	37
4.5.9.1	Roll control displacements.....	37
4.5.9.2	Roll axis control forces to achieve required roll performance.....	37
4.5.9.3	Roll axis control sensitivity.....	37
4.5.9.4	Roll axis control centering and breakout forces.....	37
4.5.9.5	Roll axis control force limits.....	37
4.5.9.5.1	Roll axis control force limits in steady turns.....	37
4.5.9.5.2	Roll axis control force limits in dives and pullouts.....	37
4.5.9.5.3	Roll axis control force limits in crosswinds.....	37
4.5.9.5.4	Roll axis control force limits in steady sideslips.....	37
4.5.9.5.5	Roll axis control force limits for asymmetric thrust.....	37
4.5.9.5.6	Roll axis control force limits for failures.....	37

MIL-STD-1797A

CONTENTS

Paragraph		Page
4.5.9.5.7	Roll axis control force limits for configuration or control mode change.....	38
4.6	Flying qualities requirements for the yaw axis	38
4.6.1	Yaw axis response to yaw and side-force controllers	38
4.6.1.1	Dynamic lateral-directional response	38
4.6.1.2	Steady sideslips.....	38
4.6.1.3	Wings-level turn.....	38
4.6.2	Yaw axis response to roll controller.....	39
4.6.3	Pilot-induced yaw oscillations.....	39
4.6.4	Yaw axis control for takeoff and landing in crosswinds.....	39
4.6.5	Yaw axis response to other inputs	39
4.6.5.1	Yaw axis response to asymmetric thrust.....	39
4.6.5.2	Yaw axis response to failures.....	40
4.6.5.3	Yaw axis response to configuration or control mode change.....	40
4.6.6	Yaw axis control power.....	40
4.6.6.1	Yaw axis control power for takeoff, landing, and taxi.....	40
4.6.6.2	Yaw axis control power for asymmetric thrust.....	41
4.6.6.3	Yaw axis control power with asymmetric loading.....	41
4.6.7	Yaw axis control forces.....	41
4.6.7.1	Yaw axis control force limits in rolling maneuvers.....	41
4.6.7.2	Yaw axis control force limits in steady turns.....	41
4.6.7.3	Yaw axis control force limits during speed changes.....	41
4.6.7.4	Yaw axis control force limits in crosswinds.....	41
4.6.7.5	Yaw axis control force limits with asymmetric loading.....	42
4.6.7.6	Yaw axis control force limits in dives and pullouts.....	42
4.6.7.7	Yaw axis control force limits for waveoff (go-around).....	42
4.6.7.8	Yaw axis control force limits for asymmetric thrust during takeoff.....	42
4.6.7.9	Yaw axis control force limits with flight control failures.....	42
4.6.7.10	Yaw axis control force limits-control mode change.....	42
4.6.7.11	Yaw axis breakout forces.....	42
4.7	Flying qualities requirements for the lateral flight path axis	42
4.7.1	Dynamic response for lateral translation.....	42
4.8	Flying qualities requirements for combined axes.....	43
4.8.1	Cross-axis coupling in roll maneuvers.....	43
4.8.2	Crosstalk between pitch and roll controllers.....	43
4.8.3	Control harmony.....	43
4.8.4	Flight at high angle of attack.....	43
4.8.4.1	Warning cues.....	43
4.8.4.2	Stalls.....	43
4.8.4.2.1	Stall approach.....	43
4.8.4.2.2	Stall characteristics.....	43
4.8.4.2.3	Stall prevention and recovery.....	44
4.8.4.2.4	One-engine-out stalls.....	44
4.8.4.3	Post-stall gyrations and spins.....	44
4.8.4.3.1	Departure from controlled flight.....	44
4.8.4.3.2	Recovery from post-stall gyrations and spins.....	44
4.9	Flying qualities requirements in atmospheric disturbances	45
4.9.1	Allowable flying qualities degradations in atmospheric disturbances.....	45
4.9.2	Definition of atmospheric disturbance model form.....	46
4.9.3	Application of disturbance models in analyses.....	46
5.	VERIFICATION.....	47
5.1	General requirements-verification.....	47
5.1.1	Loadings-verification.....	47

MIL-STD-1797A

CONTENTS

Paragraph		Page
5.1.2	Moments and products of inertia-verification	47
5.1.3	Internal and external stores-verification	47
5.1.4	Flight Envelopes-verification	47
5.1.4.1	Operational Flight Envelopes-verification	47
5.1.4.2	Service Flight Envelopes-verification	47
5.1.4.3	Permissible Flight Envelopes-verification	47
5.1.5	Configurations and States of the aircraft-verification	47
5.1.6	Aircraft Normal States-verification.....	47
5.1.6.1	Allowable Levels for Aircraft Normal States-verification.....	47
5.1.6.2	Flight outside the Service Flight Envelopes-verification.....	47
5.1.6.3	Ground operation-verification	47
5.1.7	Aircraft Failure States-verification	47
5.1.7.1	Allowable Levels for Aircraft Failure States-verification	48
5.1.7.2	Aircraft Special Failure States-verification.....	48
5.1.7.3	Probability calculation-verification	48
5.1.7.4	Generic failure analysis-verification.....	48
5.1.7.5	When Levels are not specified-verification.....	48
5.1.7.6	Failures outside the Service Flight Envelopes-verification.....	48
5.1.8	Dangerous flight conditions-verification	48
5.1.8.1	Warning and indication-verification	48
5.1.8.2	Devices for indication, warning, prevention, and recovery-verification	48
5.1.9	Interpretation of subjective requirements-verification	48
5.1.10	Interpretation of quantitative requirements-verification	48
5.1.11	General flying qualities requirements-verification.....	48
5.1.11.1	Buffet-verification	48
5.1.11.2	Release of stores-verification	48
5.1.11.3	Effects of armament delivery and special equipment-verification.....	48
5.1.11.4	Failures-verification	48
5.1.11.5	Control margin-verification.....	48
5.1.11.6	Pilot-induced oscillations(PIO)-verification	49
5.1.11.7	Residual oscillations-verification	49
5.1.11.8	Control cross-coupling-verification	49
5.1.12	General flight control system characteristics-verification	49
5.1.12.1	Control centering and breakout forces-verification.....	49
5.1.12.2	Cockpit control free play-verification	49
5.1.12.3	Adjustable controls-verification.....	49
5.1.12.4	Rate of control displacement-verification	49
5.1.12.5	Dynamic characteristics-verification	49
5.1.12.6	Damping-verification.....	49
5.1.12.7	Transfer to alternate control modes-verification.....	49
5.1.12.8	Flight control system failures-verification	49
5.1.12.9	Augmentation systems-verification.....	49
5.1.12.10	Auxiliary dive recovery devices-verification.....	49
5.1.12.11	Direct force controllers-verification	49
5.1.13	General trim requirements-verification	49
5.1.13.1	Trim system irreversibility-verification	49
5.1.13.2	Rate of trim operation-verification	50
5.1.13.3	Stalling of trim systems-verification	50
5.1.13.4	Transients and trim changes-verification.....	50
5.1.13.5	Trim for asymmetric thrust-verification	50
5.1.13.6	Automatic trim system-verification.....	50
5.2	Flying qualities requirements for the pitch axis-verification	50
5.2.1	Pitch attitude dynamic response to pitch controller-verification.....	50

MIL-STD-1797A

CONTENTS

Paragraph		Page
5.2.1.1	Long-term pitch response-verification.	50
5.2.1.2	Short-term pitch response-verification.....	50
5.2.2	Pilot-induced pitch oscillations-verification.....	50
5.2.3	Residual pitch oscillations-verification.	50
5.2.4	Normal acceleration at pilot station-verification.	50
5.2.5	Pitch trim changes-verification.	50
5.2.6	Pitch axis response to other inputs-verification.....	50
5.2.6.1	Pitch axis response to failures, controls free-verification.	50
5.2.6.2	Pitch axis response to configuration or control mode change-verification.	50
5.2.7	Pitch axis control power-verification.....	50
5.2.7.1	Pitch axis control power in unaccelerated flight-verification.....	50
5.2.7.2	Pitch axis control power in maneuvering flight-verification.....	50
5.2.7.2.1	Load factor response-verification.	51
5.2.7.3	Pitch axis control power in takeoff-verification.	51
5.2.7.4	Pitch axis control power in landing-verification.....	51
5.2.8	Pitch axis control forces-verification.....	51
5.2.8.1	Pitch axis control forces-steady-state control force per g-verification.	51
5.2.8.2	Pitch axis control forces-transient control force per g-verification.....	51
5.2.8.3	Pitch axis control forces-control force variations during rapid speed changes-verification.....	51
5.2.8.4	Pitch axis control forces-control force vs. control deflection-verification.....	51
5.2.8.5	Pitch axis control breakout forces-verification.	51
5.2.8.6	Pitch axis control force limits-verification.....	51
5.2.8.6.1	Pitch axis control force limits-takeoff-verification.....	51
5.2.8.7	Pitch axis control force limits-landing-verification.....	51
5.2.8.7.1	Pitch axis control force limits-dives-verification.	51
5.2.8.7.2	Pitch axis control force limits-sideslips-verification.....	51
5.2.8.7.3	Pitch axis control force limits-failures-verification.....	51
5.2.8.7.4	Pitch axis control force limits-control mode change-verification.....	51
5.2.8.8	Pitch axis trim systems-verification.	51
5.2.9	Pitch axis control displacements-verification.	52
5.2.9.1	Pitch axis control displacements-takeoff-verification.....	52
5.2.9.2	Pitch axis control displacements-maneuvering-verification.....	52
5.3	Flying qualities requirements for the normal (flight path) axis-verification.....	52
5.3.1	Flight path response to attitude change-verification.	52
5.3.1.1	Transient flight path response to attitude change-verification.....	52
5.3.1.2	Steady-state flight path response to attitude change-verification.....	52
5.3.2	Flight path response to designated flight path controller-verification.....	52
5.3.3	Flight path control power-verification.	52
5.3.3.1	Control power for designated primary flight path controller-verification.	52
5.3.3.2	Control power for designated secondary flight path controller-verification.	52
5.3.4	Flight path controller characteristics-verification.	52
5.4	Flying qualities requirements for the longitudinal (speed) axis-verification.	52
5.4.1	Speed response to attitude changes-verification.....	52
5.4.1.1	Speed response to attitude changes-relaxation in transonic flight-verification.	52
5.5	Flying qualities requirements for the roll axis-verification.	52
5.5.1	Roll response to roll controller-verification.	52
5.5.1.1	Roll mode-verification.	52
5.5.1.2	Spiral stability-verification.....	52
5.5.1.3	Coupled roll-spiral oscillation-verification.....	52
5.5.1.4	Roll oscillations-verification.	52
5.5.1.5	Roll time delay-verification.....	52
5.5.2	Pilot-induced roll oscillations-verification.	53
5.5.3	Linearity of roll response to roll controller-verification.....	53

MIL-STD-1797A

CONTENTS

Paragraph		Page
5.5.4	Lateral acceleration at the pilot station-verification.....	53
5.5.5	Roll characteristics in steady sideslip-verification.....	53
5.5.6	Roll axis control for takeoff and landing in crosswinds-verification.....	53
5.5.7.1	Roll axis response to augmentation failures-verification.....	53
5.5.7.2	Roll axis response to configuration or control mode change-verification.....	53
5.5.8	Roll axis control power-verification.....	53
5.5.8.1	Roll axis response to augmentation failures-verification.....	53
5.5.8.2	Roll axis control power in steady slips-verification.....	53
5.5.8.3	Roll axis control power in crosswinds-verification.....	53
5.5.8.4	Roll axis control power for asymmetric thrust-verification.....	53
5.5.8.5	Roll axis control power in dives and pullouts-verification.....	53
5.5.8.6	Roll axis control power for asymmetric loading-verification.....	53
5.5.9	Roll axis control forces and displacements-verification.....	54
5.5.9.1	Roll control displacements-verification.....	54
5.5.9.2	Roll axis control forces to achieve required roll performance-verification.....	54
5.5.9.3	Roll axis control sensitivity-verification.....	54
5.5.9.4	Roll axis control centering and breakout forces-verification.....	54
5.5.9.5	Roll axis control force limits-verification.....	54
5.5.9.5.1	Roll axis control force limits in steady turns-verification.....	54
5.5.9.5.2	Roll axis control force limits in dives and pullouts-verification.....	54
5.5.9.5.3	Roll axis control force limits in crosswinds-verification.....	54
5.5.9.5.4	Roll axis control force limits in steady sideslips-verification.....	54
5.5.9.5.5	Roll axis control force limits for asymmetric thrust-verification.....	54
5.5.9.5.6	Roll axis control force limits for failures-verification.....	54
5.5.9.5.7	Roll axis control force limits for configuration or control mode change-verification.....	54
5.6	Flying qualities requirements for the yaw axis-verification.....	54
5.6.1	Yaw axis response to yaw and side-force controllers-verification.....	54
5.6.1.1	Dynamic lateral-directional response-verification.....	54
5.6.1.2	Steady sideslips-verification.....	54
5.6.1.3	Wings-level turn-verification.....	54
5.6.2	Yaw axis response to roll controller-verification.....	54
5.6.3	Pilot-induced yaw oscillations-verification.....	55
5.6.4	Yaw axis control for takeoff and landing in crosswinds-verification.....	55
5.6.5	Yaw axis response to other inputs-verification.....	55
5.6.5.1	Yaw axis response to asymmetric thrust-verification.....	55
5.6.5.2	Yaw axis response to failures-verification.....	55
5.6.5.3	Yaw axis response to configuration or control mode change-verification.....	55
5.6.6	Yaw axis control power-verification.....	55
5.6.6.1	Yaw axis control power for takeoff, landing, and taxi-verification.....	55
5.6.6.2	Yaw axis control power for asymmetric thrust-verification.....	55
5.6.6.3	Yaw axis control power with asymmetric loading-verification.....	55
5.6.7	Yaw axis control forces-verification.....	55
5.6.7.1	Yaw axis control force limits in rolling maneuvers-verification.....	55
5.6.7.2	Yaw axis control force limits in steady turns-verification.....	55
5.6.7.3	Yaw axis control force limits during speed changes-verification.....	55
5.6.7.4	Yaw axis control force limits in crosswinds-verification.....	55
5.6.7.5	Yaw axis control force limits with asymmetric loading-verification.....	55
5.6.7.6	Yaw axis control force limits in dives and pullouts-verification.....	55
5.6.7.7	Yaw axis control force limits for waveoff (go-around)-verification.....	55
5.6.7.8	Yaw axis control force limits for asymmetric thrust during takeoff-verification.....	56
5.6.7.9	Yaw axis control force limits with flight control failures-verification.....	56
5.6.7.10	Yaw axis control force limits-control mode change-verification.....	56
5.6.7.11	Yaw axis breakout forces-verification.....	56

MIL-STD-1797A

CONTENTS

Paragraph		Page
5.7	Flying qualities requirements for the lateral flight path axis-verification.....	56
5.7.1	Dynamic response for lateral translation-verification.	56
5.8	Flying qualities requirements for combined axes-verification	56
5.8.1	Cross-axis coupling in roll maneuvers-verification.....	56
5.8.2	Crosstalk between pitch and roll controllers-verification.....	56
5.8.3	Control harmony-verification.	56
5.8.4	Flight at high angle of attack-verification	56
5.8.4.1	Warning cues-verification.	56
5.8.4.2	Stalls-verification.	56
5.8.4.2.1	Stall approach-verification.	56
5.8.4.2.2	Stall characteristics-verification.	56
5.8.4.2.3	Stall prevention and recovery-verification.	56
5.8.4.2.4	One-engine-out stalls-verification.....	56
5.8.4.3	Post-stall gyrations and spins-verification.....	56
5.8.4.3.1	Departure from controlled flight-verification.....	56
5.8.4.3.2	Recovery from post-stall gyrations and spins-verification.....	57
5.9	Flying qualities requirements in atmospheric disturbances-verification.....	57
5.9.1	Allowable flying qualities degradations in atmospheric disturbances-verification.....	57
5.9.2	Definition of atmospheric disturbance model form-verification.	57
5.9.3	Application of disturbance models in analyses-verification.....	57
6.	NOTES	57
6.1	Intended use.....	57
6.2	Level definitions.	57
6.3	Reference documents tree.....	57
6.4	Data requirements.....	58
6.5	Subject term (key word) listing.....	59
6.6	Responsible engineering office (REO).....	59
6.7	Changes from previous issue.....	59

FIGURES

Figure		Page
Figure 1.	Roll-sideslip coupling parameters--right rolls.....	10/11
Figure 2.	Roll-sideslip coupling parameters--left rolls.....	12/13

TABLES

Table		Page
TABLE I.	Operational Flight Envelope.....	20
TABLE II.	Aircraft Normal States.	22
TABLE III.	Levels for Aircraft Failure States.	23
TABLE IV.	Pitch trim change conditions.....	30
TABLE V.	Flying qualities in atmospheric disturbances for Aircraft Normal States.....	45
TABLE VI.	Flying qualities in atmospheric disturbances for Aircraft Failure States.....	46

MIL-STD-1797A

1. SCOPE

1.1 Purpose.

This standard contains the requirements for the flying and ground handling qualities of _____. It is intended to assure flying qualities for adequate mission performance and flight safety regardless of the design implementation or flight control system augmentation.

1.2 Applicability.

The requirements of this standard, with blanks filled in, are to be applied during the design, construction, testing and acceptance of the subject aircraft.

2. APPLICABLE DOCUMENTS

2.1 Government documents.

2.1.1 Specifications, standards, and handbooks.

The following specifications, standards, and handbooks form a part of this document to the extent specified herein. Unless otherwise specified, the issues of these documents are those listed in the issue of the Department of Defense Index of Specifications and Standards (DODISS) and supplement thereto, cited in the solicitation (see 6.2).

SPECIFICATIONS

Military

MIL-C-18244 Control and Stabilization Systems: Automatic, Piloted Aircraft, General Specification for

MIL-F-87242 Flight Control Systems, General Specification for

(Unless otherwise indicated, copies of federal and military specifications, standards and handbooks are available from Military Specifications and Standards, Bldg 4D, 700 Robbins Avenue, Philadelphia, PA 19111-5094).

2.1.2 Other Government documents, drawings, and publications.

The following other Government documents, drawings, and publications form a part of this standard to the extent specified herein. Unless otherwise specified, the issues are those cited in the solicitation.

2.2 Non-Government publications.

The following document(s) form a part of this standard to the extent specified herein. Unless otherwise specified, the issues of the documents which are DoD adopted are those listed in the issue of the DODISS cited in the solicitation. Unless otherwise specified, the issues of the documents not listed in the DODISS are the issues of the documents cited in the solicitation.

(Application for copies should be addressed to _____.)

(Nongovernment standards and other publications are normally available from organizations that prepare or distribute the documents. These documents also may be available in or through libraries or other information services.)

2.3 Order of precedence.

In the event of a conflict between the text of this document and the references cited herein, the text of this document shall take precedence. Nothing in this document, however, supersedes applicable laws and regulations unless a specific exemption has been obtained.

3. DEFINITIONS

3.1 Aircraft classification and operational missions.

For the purpose of this standard, the aircraft specified in this requirement is to accomplish the following missions: _____. The aircraft thus specified will be a Class _____ aircraft. The letter -L following a class designation identifies an aircraft as land-based; carrier-based aircraft are similarly identified by -C. When no such differentiation is made in a requirement, the requirement applies to both land-based and carrier-based aircraft.

3.2 Flight Phase Categories.

To accomplish the mission requirements the following general Flight Phase Categories are involved: _____. Special Flight Phases to be considered are: _____.

3.3 Levels and qualitative suitability of flying qualities.

The handling characteristics described in this standard are specified in terms of qualitative degrees of suitability and Levels. The degrees of suitability are defined as:

Satisfactory	Flying qualities clearly adequate for the mission Flight Phase. Desired performance is achievable with no more than minimal pilot compensation.
Acceptable	Flying qualities adequate to accomplish the mission Flight Phase, but some increase in pilot workload or degradation in mission effectiveness, or both, exists.
Controllable	Flying qualities such that the aircraft can be controlled in the context of the mission Flight Phase, even though pilot workload is excessive or mission effectiveness is inadequate, or both. The pilot can transition from Category A Flight Phase tasks to Category B or C Flight Phases, and Category B and C Flight Phase tasks can be completed.

Level 1 is Satisfactory, Level 2 is Acceptable, and Level 3 is Controllable. In the presence of higher intensities of atmospheric disturbances, 4.9.1 states the relationship between Levels and qualitative degrees of suitability. Where possible, the flying qualities requirements are stated for each Level in terms of limiting values of one or more parameters. Each value, or combination of values, represents a minimum condition necessary to meet one of the three Levels of acceptability.

It is to be noted that Level 3 is not necessarily defined as safe. This is consistent with the Cooper-Harper rating scale: for Cooper-Harper ratings of 8 and 9, controllability may be in question. If safe characteristics are required for Level 3, then action must be taken to improve aircraft flying qualities.

In some cases sufficient data do not exist to allow the specification of numerical values of a flying quality parameter. In such cases it is not possible to define explicitly a quantitative boundary of each Level, so the required Levels are then to be interpreted in terms of qualitative degrees of suitability for the piloting tasks appropriate for mission accomplishment.

3.4 Parameters.

Terms and symbols used throughout this standard are defined as follows:

3.4.1 General terms

S	Wing area
s	Laplace operator
\bar{q}	Dynamic pressure
MSL	Mean Sea Level
T_2	Time to double amplitude; $T_2 = -0.693/\zeta\omega_n$ for oscillations, $T_2 = -0.693T$ for first-order divergencies, T is the modal time constant
T	Time delay

MIL-STD-1797A

Service ceiling	Altitude at a given airspeed at which the rate of climb is 100 ft/min at the stated weight and engine thrust
Combat ceiling	Altitude at a given airspeed at which the rate of climb is 500 ft/min at the stated weight and engine thrust
Cruising ceiling	Altitude at a given airspeed at which the rate of climb is 300 ft/min at NRT at the stated weight
h_{max}	Maximum service altitude (defined in 4.1.4.2)
$h_{o_{max}}$	Maximum operational altitude (4.1.4.1)
h_{omin}	Minimum operational altitude (4.1.4.1)
c.g.	Aircraft center of gravity

3.4.2 Speeds

Airspeed	Magnitude of the velocity with respect to the air mass
Equivalent airspeed, EAS	True airspeed multiplied by $\sqrt{\sigma}$ where σ , is the ratio of free-stream density at the given altitude to standard sea-level air density
Calibrated airspeed, CAS	Airspeed-indicator reading corrected for position and instrument error but not for compressibility
Refusal speed	The maximum speed to which the aircraft can accelerate and then stop in the available runway length
M	Mach number
V	Airspeed along the flight path (where appropriate, V may be replaced by M in this standard)
V_s	Stall speed (equivalent airspeed), at 1g normal to the flight path, defined as the highest of: <ol style="list-style-type: none">Speed for steady straight flight at C_{Lmax}, the first local maximum of the curve of lift coefficient ($L/\bar{q} S$) vs. angle of attack which occurs as C_L is increased from zero.Speed at which uncommanded pitching, rolling or yawing occurs (4.8.4.2).Speed at which intolerable buffet or structural vibration is encountered.

MIL-STD-1797A

Conditions for determining V_S

The aircraft shall be initially trimmed at approximately $1.2 V_S$ with the following settings, after which the trim and throttle settings shall be held constant:

FLIGHT PHASE	THRUST SETTINGS*	TRIM SETTING
Climb (CL)	Normal climb	For straight flight
Descent (D)	Normal descent	For straight flight
Emergency descent (ED)	Idle	For straight flight
Emergency deceleration (DE)	Idle	For straight flight
Takeoff (TO)	Takeoff	Recommended takeoff setting
Approach (PA)	Normal approach	For normal approach
Waveoff/Go-around (WO)	Takeoff	For normal approach
Landing (L)	Idle	For normal approach
All other	TLF at $1.2 V_S$	For straight flight

* - Either on all engines or on remaining engines with critical engine inoperative, whichever yields the higher value of V_S .

In flight test, it is necessary to reduce speed very slowly (typically 1/2 knot per second or less) to minimize dynamic lift effects. The load factor will generally not be exactly 1g when stall occurs; when this is the case, V_S is defined as follows:

$$V_S = \frac{V}{\sqrt{n_f}}$$

where V and n_f are the measured values at stall, n_f being the load factor normal to the flight path.

$V_S(X)$, $V_{\min}(X)$, $V_{\max}(X)$ Short-hand notation for the speeds V_S , V_{\min} , V_{\max} for a given configuration, weight, center-of-gravity position, and external store combination associated with Flight Phase X. For example, the designation $V_{\max}(TO)$ is used in 4.2.8.6.1 to emphasize that the speed intended (for the weight, center of gravity and external store combination under consideration) is V_{\max} for the configuration associated with the takeoff Flight Phase. This is necessary to avoid confusion, since the configuration and Flight Phase change from takeoff to climb during the maneuver.

V_{trim} Trim speed

MIL-STD-1797A

V_{end}	Speed for maximum endurance
$V_{L/D}$	Speed for maximum lift-to-drag ratio
$V_{R/C}$	Speed for maximum rate of climb
V_{range}	Speed for maximum range with zero wind
V_{NRT}	High speed, level flight, normal rated thrust
V_{MRT}	High speed, level flight, military rated thrust
V_{MAT}	High speed, level flight, maximum augmented thrust
V_{max}	Maximum service speed (defined in 4.1.4.2)
V_{min}	Minimum service speed (defined in 4.1.4.2)
$V_{o_{max}}$	Maximum operational speed (4.1.4.1)
$V_{o_{min}}$	Minimum operational speed (4.1.4.1)
V_G	Gust penetration speed
V_{MCA}, V_{MC}	Minimum controllable airspeed while airborne
V_{MCG}	Minimum controllable airspeed while on the ground

3.4.3 Thrust and power

Thrust and power	For propeller-driven aircraft, the word "thrust" shall be replaced by the word "power" throughout the standard
TLF	Thrust for level flight
NRT	Normal rated thrust, which is the maximum thrust at which the engine can be operated continuously
MRT	Military rated thrust, which is the maximum thrust at which the engine can be operated for a specified period
MAT	Maximum augmented thrust: maximum thrust, augmented by all means available for the Flight Phase
Takeoff thrust	Maximum thrust available for takeoff

MIL-STD-1797A

3.4.4 Control parameters

Pitch, roll, yaw controls	The stick or wheel and pedals manipulated by the pilot to produce pitching, rolling and yawing moments respectively; the cockpit controls
Pitch control force, F_{es}	Component of applied force, exerted by the pilot on the cockpit control in the direction to command pitch, acting at the center of the stick grip or wheel in a direction perpendicular to a line between the center of the stick grip and the stick control column pivot
δ_{es}	Deflection of the cockpit pitch controller
Roll control force, F_{as}	For a stick control, the component of control force exerted by the pilot in the direction to command roll, acting at the center of the stick grip in a direction perpendicular to a line between the center of the stick grip and the stick pivot. For a wheel control, the total moment applied by the pilot about the wheel axis in the plane of the wheel divided by the average radius from the wheel pivot to the pilot's grip
δ_{as}	Deflection of the cockpit roll controller
Yaw-control pedal force, F_{rp}	Difference of push-force components of forces exerted by the pilot on the yaw-control pedals, lying in planes parallel to the plane of symmetry, measured perpendicular to the pedals at the normal point of application of the pilot's instep on the respective yaw-control pedals.
δ_{rp}	Deflection of the cockpit yaw controller
Control effectors	The aerodynamic surfaces, thrust vectoring, reaction controls, etc., which produce forces and moments to control the aircraft.
Direct normal force control	A device producing direct normal force for the primary purpose of controlling the flight path of the aircraft. The term describes the concept of directly modulating the normal force on an aircraft by changing its lifting capabilities at a constant angle of attack and constant airspeed or by controlling the normal force component of such items as jet exhausts, propellers, and fans
Control power	Effectiveness of control surfaces in applying forces or moments to an aircraft. For example, 50 percent of available roll control power is 50 percent of the maximum rolling moment that is available to the pilot with allowable roll control force

3.4.5 Longitudinal parameters

$1/T_{\theta_1}$	Low-frequency pitch attitude zero
$1/T_{\theta_2}$	High-frequency pitch attitude zero
ζ_{sp}	Damping ratio of the short-period oscillation

MIL-STD-1797A

ω_{sp}	Undamped natural frequency of the short-period oscillation
ζ_p	Damping ratio of the phugoid oscillation
ω_p	Undamped natural frequency of the phugoid oscillation
ω_{BW}	Bandwidth frequency, with stated minimum phase and gain margins (generally 60 deg and 6 dB resp.)
n	Normal acceleration or normal load factor, g's, measured at the c.g. unless the location is otherwise specified
n_z	Normal acceleration measured at the instantaneous center of rotation for pitch control inputs
n_L	Symmetrical flight limit load factor for a given Aircraft Normal State, based on structural considerations
n_{max}, n_{min}	Maximum and minimum service load factors
$n(+), n(-)$	For a given altitude, the upper and lower boundaries of n in the V-n diagrams depicting the Service Flight Envelope
$n_{o_{max}}, n_{o_{min}}$	Maximum and minimum operational load factors
$n_o(+), n_o(-)$	For given altitude, the upper and lower boundaries of n in the V-n diagrams depicting the Operational Flight Envelope (4.1.4.1)
α	Angle of attack; the angle in the plane of symmetry between the fuselage reference line and the tangent to the flight path at the aircraft center of gravity
α_S	The stall angle of attack at constant speed for the configuration, weight, center-of-gravity position and external store combination associated with a given Aircraft Normal State; defined as the lowest of the following: <ol style="list-style-type: none">Angle of attack for the highest steady load factor, normal to the flight path, that can be attained at a given speed or Mach numberAngle of attack, for a given speed or Mach number, at which uncommanded pitching, rolling or yawing occurs (4.8.4.2)Angle of attack, for a given speed or Mach number, at which intolerable buffeting is encountered
$C_{L_{stall}}$	Lift coefficient at α_S defined above
n/α	The steady-state normal acceleration change per unit change in angle of attack for an incremental pitch control deflection at constant speed (airspeed and Mach number)

MIL-STD-1797A

F_s/n	Gradient of steady-state pitch control force versus n at constant speed (4.2.8.1)
γ	Climb angle, positive for climbing flight $\gamma = \sin^{-1}$ (vertical speed/true airspeed)
θ	Pitch attitude, the angle between the x-axis and the horizontal
L	Aerodynamic lift plus thrust component normal to the flight path

3.4.6 Lateral-directional parameters

T_R	First-order roll mode time constant, positive for stable mode
T_S	First-order spiral mode time constant, positive for stable mode
ω_ϕ	Undamped natural frequency of numerator quadratic of ϕ/F_{as} transfer function
ζ_ϕ	Damping ratio of numerator quadratic of ϕ/F_{as} transfer function
ω_d	Undamped natural frequency of the dutch roll oscillation
ζ_d	Damping ratio of the dutch roll oscillation
T_d	Damped period of the dutch roll, $T_d = \frac{2\pi}{\omega_d \sqrt{1 - \zeta_d^2}}$
ω_{RS}	Undamped natural frequency of a coupled roll-spiral oscillation
ζ_{RS}	Damping ratio of a coupled roll-spiral oscillation
ϕ	Bank angle measured in the y-z plane, between the y-axis and the horizontal
ϕ_t	Bank angle change in time t , in response to a control deflection of the form given in 4.5.8.1
p	Roll rate about the x-axis
$\delta'_{rp}(3)$	Yaw-to-roll crossfeed parameter (4.6.2)
p_{osc}/p_{av}	A measure of the ratio of the oscillatory component of roll rate to the average component of roll rate following a yaw-control-free step roll control command:

$$\zeta_d \leq 0.2 : \frac{p_{osc}}{p_{av}} = \frac{p_1 + p_3 - 2p_2}{p_1 + p_3 + 2p_2}$$

$$\zeta_d > 0.2 : \frac{p_{osc}}{p_{av}} = \frac{p_1 - p_2}{p_1 + p_2}$$

MIL-STD-1797A

where p_1, p_2 and p_3 are roll rates at the first, second and third peaks, respectively (figures 1 and 2)

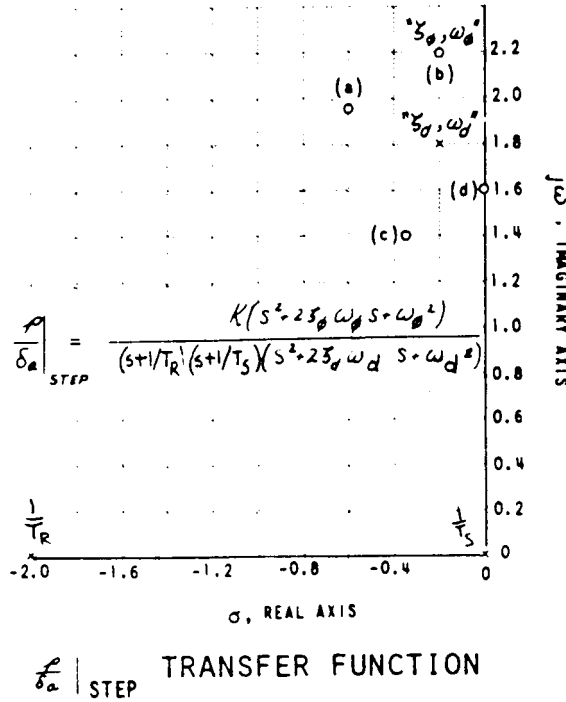

ϕ_{osc}/ϕ_{av}

A measure of the ratio of the oscillatory component of bank angle to the average component of bank angle following a pedals-free impulse aileron control command:

$$\zeta_d \leq 0.2 : \frac{\phi_{osc}}{\phi_{av}} = \frac{\phi_1 + \phi_3 - 2\phi_2}{\phi_1 + \phi_3 + 2\phi_2}$$

$$\zeta_d > 0.2 : \frac{\phi_{osc}}{\phi_{av}} = \frac{\phi_1 - \phi_2}{\phi_1 + \phi_2}$$

where $\phi_1, \phi_2,$ and ϕ_3 are bank angles at the first, second and third peaks, respectively

β

Sideslip angle at the center of gravity, angle between undisturbed flow and plane of symmetry; positive, or right sideslip corresponds to incident flow approaching from the right side of the plane of symmetry

$\Delta\beta_{max}$

Maximum change in sideslip occurring within 2 seconds or one half-period of the dutch roll, whichever is greater, for a step roll-control command (figures 1 and 2)

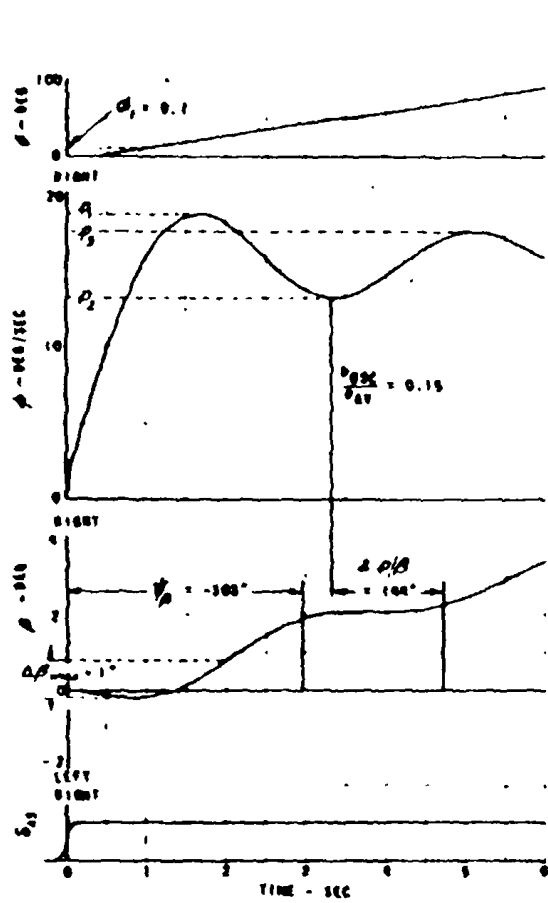

(a)

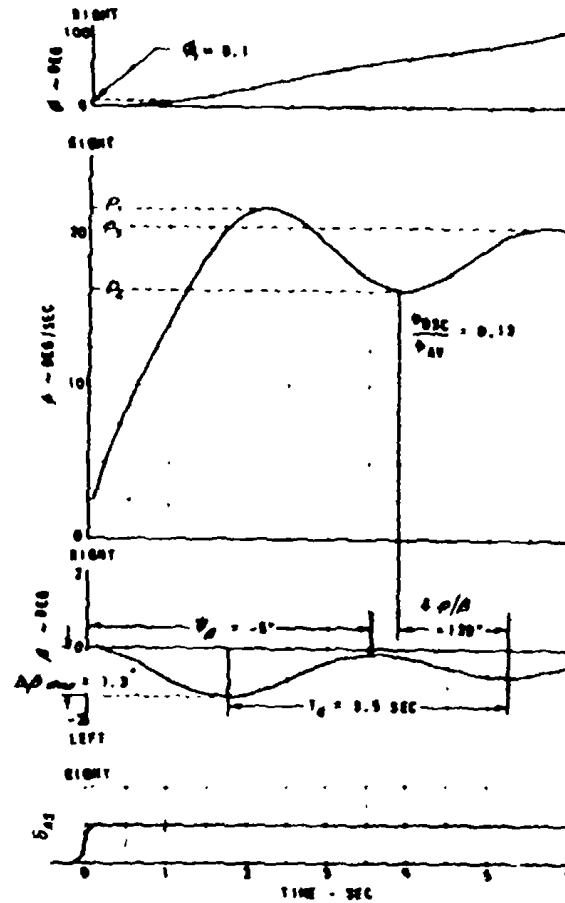

(b)

Figure 1. Roll-sideslip coupling parameters--right rolls.

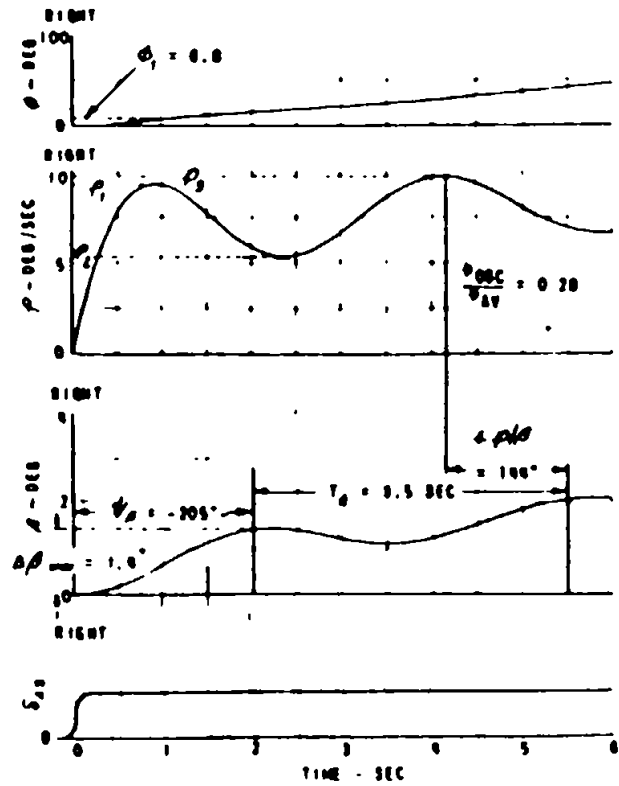

(c)

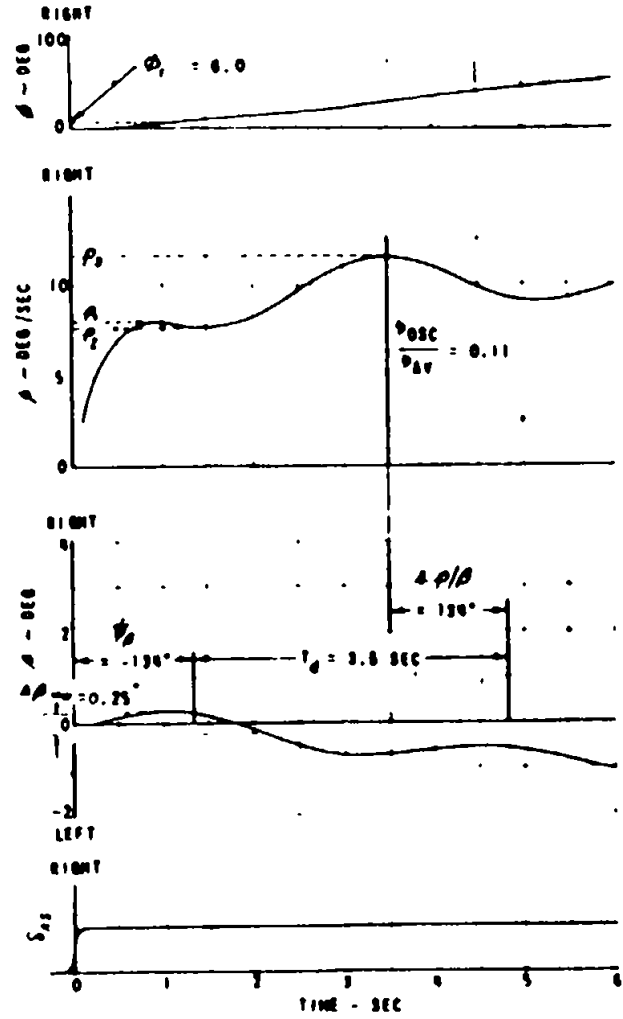

(d)

FIGURE 1. Roll-sideslip coupling parameters--right rolls. -continued

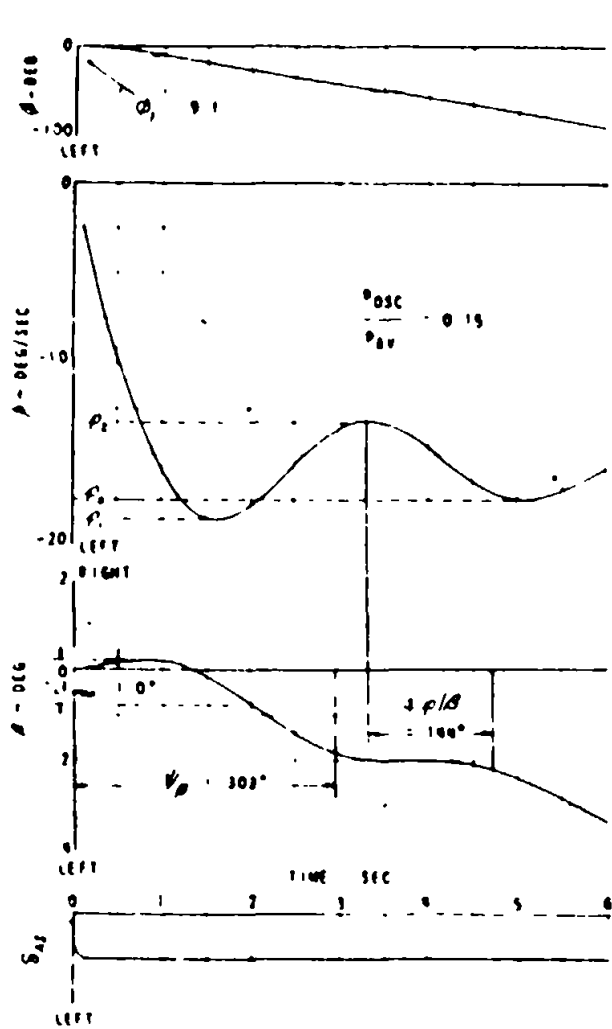

(a)

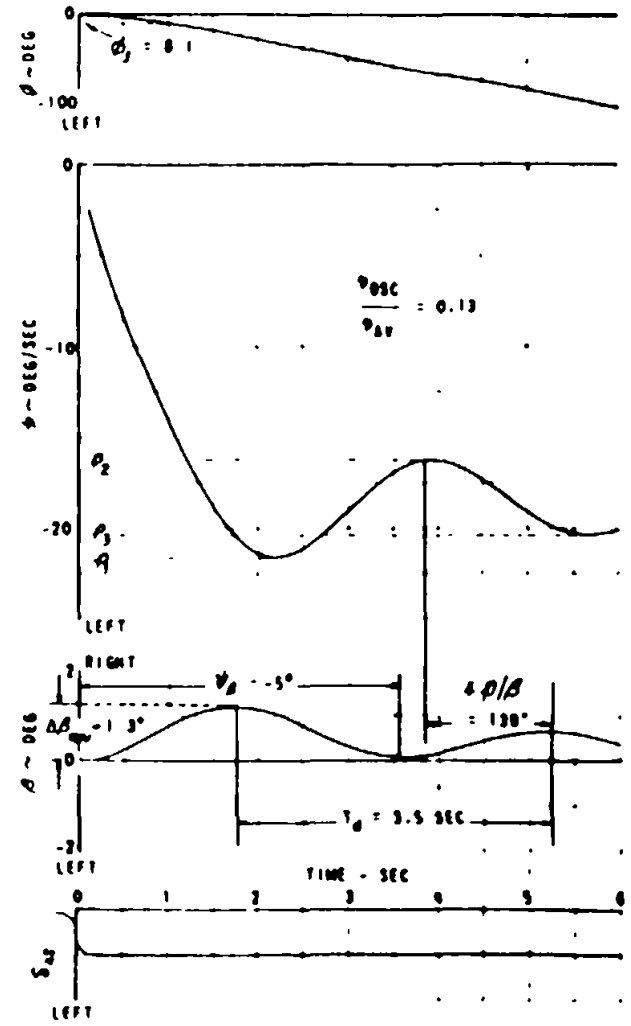

(b)

Figure 2. Roll-sideslip coupling parameters--left rolls.

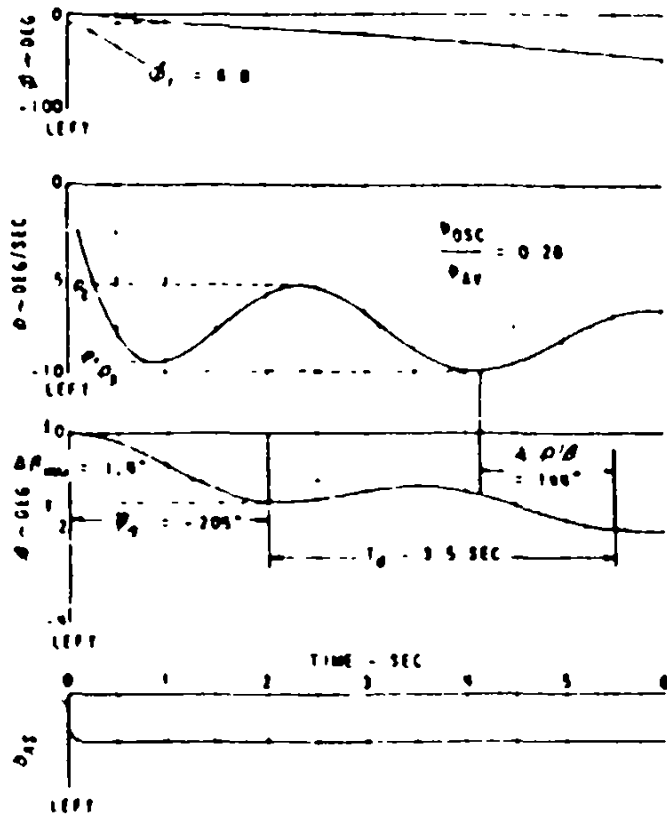

(c)

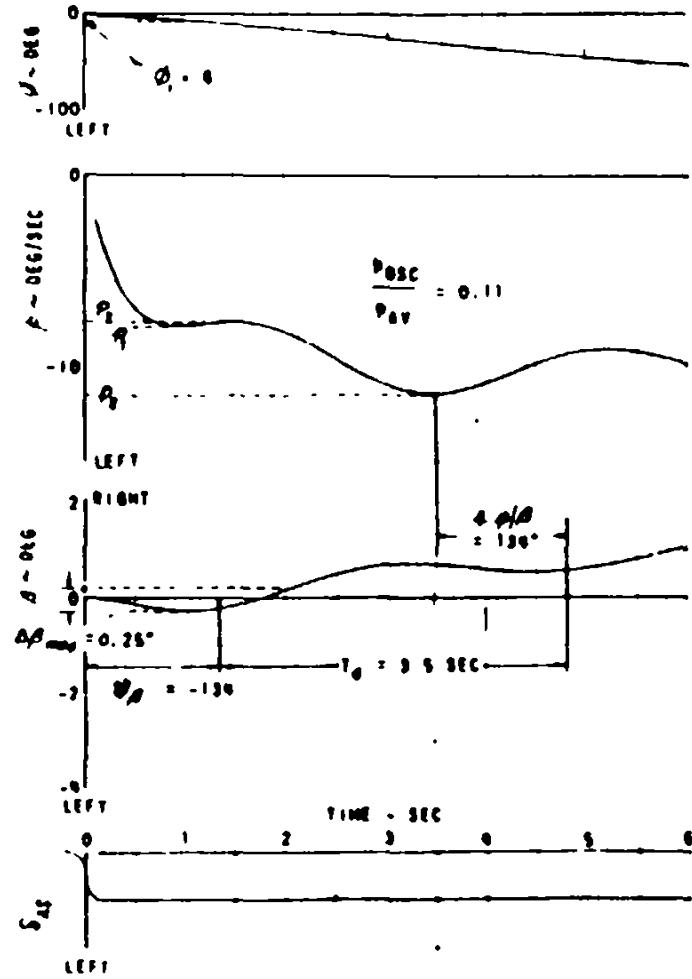

(d)

FIGURE 2. Roll-Sideslip coupling parameters--left rolls. - continued

MIL-STD-1797A

k	<p>Ratio of "commanded roll performance" to "applicable roll performance requirement" of 4.5.8.1, where:</p> <p>a. "Applicable roll performance requirement," $(\phi_t)_{\text{requirement}}$ is determined from 4.5.8.1 for the Class and Flight Phase Category under consideration</p> <p>b. "Commanded roll performance," $(\phi_t)_{\text{command}}$, is the bank angle attained in the stated time for a given step roll command with yaw control pedals employed as specified in 4.5.8.1</p> $k = \frac{(\phi_t)_{\text{command}}}{(\phi_t)_{\text{requirement}}}$
$t_{n\beta}$	<p>Time for the dutch roll oscillation in the sideslip response to reach the nth local maximum for a right step or pulse roll-control command, or the nth local minimum for a left command. In the event a step control input cannot be accomplished, the control shall be moved as abruptly as practical and, for purposes of this definition, time shall be measured from the instant the cockpit control deflection passes through half the amplitude of the commanded value. For pulse inputs, time shall be measured from a point halfway through the duration of the pulse</p>
ψ_β	<p>Phase angle expressed as a lag for a cosine representation of the dutch roll oscillation in sideslip, where</p> $\psi_\beta = -\frac{360}{T_d} t_{n\beta} + (n-1) 360 \text{ (degrees)}$ <p>with n as used in the definition of $t_{n\beta}$ above</p>
$\angle p / \beta$	<p>Phase angle between roll rate and sideslip in the free dutch roll oscillation. Angle is positive when p leads β by an angle between 0 and 180 deg</p>
$ \phi/\beta _d$	<p>At any instant, the ratio of amplitudes of the bank-angle and sideslip-angle envelopes in the dutch roll mode</p>

Examples showing measurement of roll-sideslip coupling parameters are shown on figure 1 for right rolls and figure 2 for left rolls. Since several oscillations of the dutch roll are required to measure these parameters, and since for proper identification large roll rates and bank angle changes must generally be avoided, step roll control inputs should be small. It should be noted that since ψ_β is the phase angle of the dutch roll component of sideslip, care must be taken to select a peak far enough downstream that the position of the peak is not influenced by the roll mode. In practice, peaks occurring one or two roll mode time constants after the aileron input will be relatively undistorted. Care must also be taken when there is ramping of the sideslip trace, since ramping will displace the position of a peak of the trace from the corresponding peak of the dutch roll component. In practice, the peaks of the dutch roll component of sideslip are located by first drawing a line through the ramping portion of the sideslip trace and then noting the times at which the vertical distance between the line and the sideslip trace is the greatest [See Case (a) of the following enlarged section of figures 1 and 2].

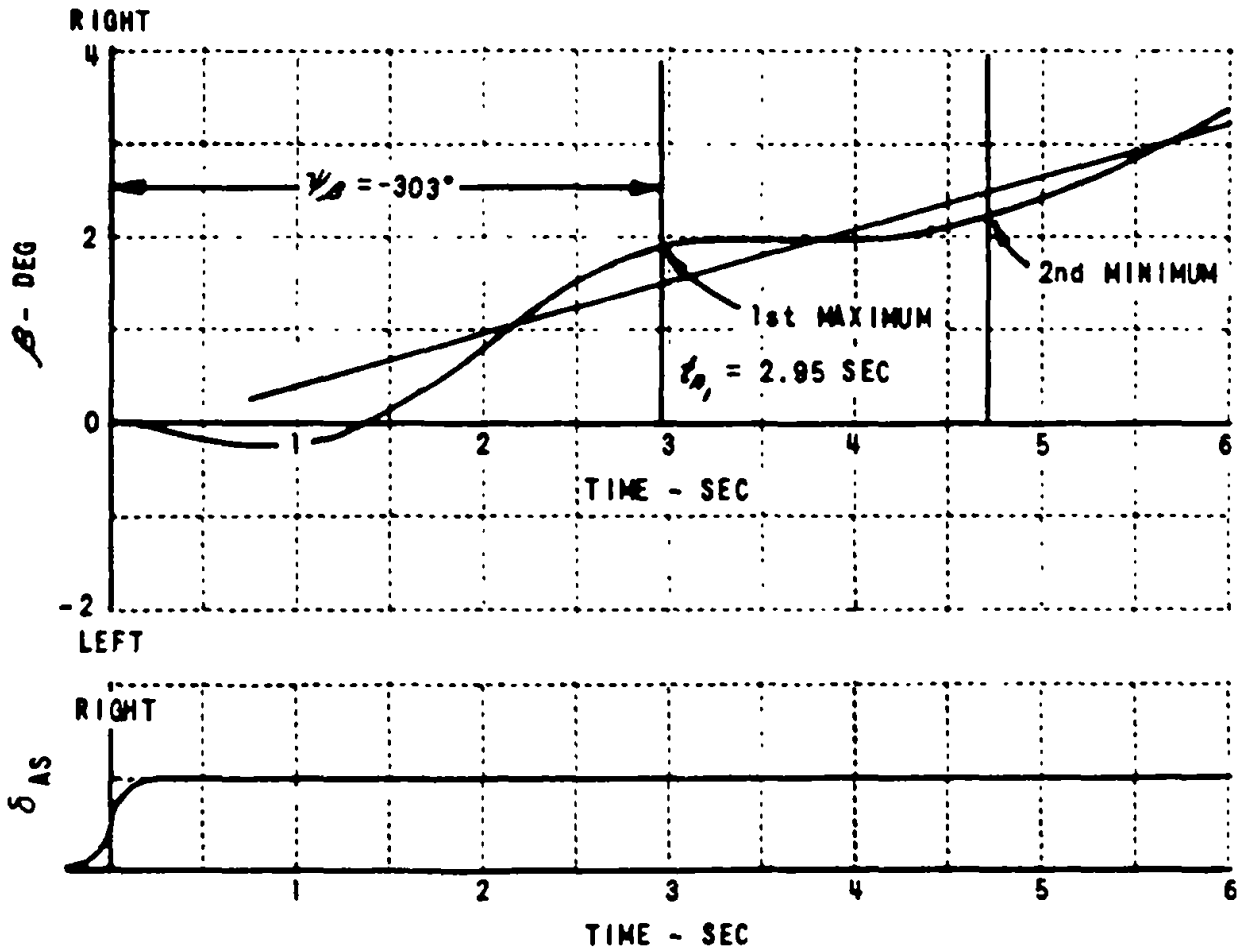

Since the first local maximum of the dutch roll component of the sideslip response occurs at $t = 2.95$ seconds,

$$\psi_\beta = -\frac{360}{T_d} t_{n\beta} + (n-1) 360 \text{ (degrees)} = \frac{-360}{3.5} (2.95) = -303 \text{ degrees}$$

MIL-STD-1797A

For example, if the roll performance requirement is $\phi_t = 30$ degrees in one second with rudder pedals free (as in the rolls of 4.5.8.1), then from the definitions, "k" for this condition is

$$k = \frac{(\phi_t)_{\text{common}}}{(\phi_t)_{\text{requirement}}}$$

Therefore from figures 1 and 2:

Case (a): $k = 9.1/30 = 0.30$

Case (c): $k = 6.8/30 = 0.23$

Case (b): $k = 8.1/30 = 0.27$

Case (d): $k = 6.0/30 = 0.20$

\dot{r}_o / \dot{p}_o Ratio of initial yawing acceleration to initial rolling acceleration for a step roll control input (equivalent to $N'_{\delta_{as}} / L'_{\delta_{as}}$)

μ Rudder shaping parameter:
 $\mu = \delta_{rp}(3) - 1$ where $\delta_{rp}(3)$ is the rudder pedal deflection, 3 seconds after a step roll control input, that would be required for perfect coordination (see 4.6.2 Guidance)

3.4.7 Atmospheric disturbance parameters

j $\sqrt{-1}$

Ω Spatial (reduced) frequency (radians per foot)

ω Temporal frequency (radians per second), where $\omega = \Omega V$

t Time (seconds)

u_g Translational disturbance velocity along the x-axis, positive forward (feet per second)

v_g Translational disturbance velocity along the y-axis, positive to pilot's right (feet per second)

w_g Translational disturbance velocity along the z-axis, positive down (feet per second)

Note: Random u_g , v_g , w_g have Gaussian (normal) distributions

V_{wd} Velocity of wind over deck (feet per second)

MIL-STD-1797A

σ , RMS	Root-mean-square disturbance intensity, where $\sigma^2 = \int_0^\infty \Phi(\Omega) d\Omega = \int_0^\infty \phi(\omega) d\omega$
σ_u	Root-mean-square intensity of u_g (feet per second)
σ_v	Root-mean-square intensity of v_g (feet per second)
σ_w	Root-mean-square intensity of w_g (feet per second)
L_u	Scale for u_g (feet)
L_v	Scale for v_g (feet)
L_w	Scale for w_g (feet)
$\Phi_{u_g}(\Omega)$	Spectrum for u_g , where $\Phi_{u_g}(\Omega) = V\phi_{u_g}(\omega)$ (ft ³ /sec ²)
$\Phi_{v_g}(\Omega)$	Spectrum for v_g , where $\Phi_{v_g}(\Omega) = V\phi_{v_g}(\omega)$ (ft ³ /sec ²)
$\Phi_{w_g}(\Omega)$	Spectrum for w_g , where $\Phi_{w_g}(\Omega) = V\phi_{w_g}(\omega)$ (ft ³ /sec ²)
v_m	Generalized discrete gust intensity, positive along the positive axes, $m = x, y, z$ (feet per second)
d_m	Generalized discrete gust length (always positive), $m = x, y, z$ (feet)
u_{20}	Wind speed at 20 feet above the ground (feet per second)
X	Distance from aircraft to ship center of pitch, negative aft of ship (feet)
ψ_w	Mean wind direction relative to runway
p_g	Rotary disturbance velocity about the x-axis (radians per second)
q_g	Rotary disturbance velocity about the y-axis (radians per second)
r_g	Rotary disturbance velocity about the z-axis (radians per second)
Φ_{p_g}	Spectrum for p_g (ft/sec ²)
Φ_{q_g}	Spectrum for q_g (ft/sec ²)
Φ_{r_g}	Spectrum for r_g (ft/sec ²)

3.5 Terms used in high angle of attack requirements

Post-stall	The flight regime involving angles of attack greater than nominal stall angles of attack. The aircraft characteristics in the post-stall regime may consist of three more or less distinct consecutive types of aircraft motion following departure from controlled flight: post-stall gyration, incipient spin, and developed spin
Post-stall gyration (PSG)	Uncontrolled motions about one or more aircraft axes following departure from controlled flight. While this type of aircraft motion involves angles of attack higher than stall angle, lower angles may be encountered intermittently in the course of the motion
Spin	That part of the post-stall aircraft motion which is characterized by a sustained yaw rotation. The spin may be upright or inverted, flat (high angle of attack) or steep (low but still stalled angle of attack) and the rotary motions may have oscillations in pitch, roll and yaw superimposed on them. The incipient spin is the initial, transient phase of the motion during which it is not possible to identify the spin mode, usually followed by the developed spin, the phase during which it is possible to identify the spin mode.

4. REQUIREMENTS

4.1 General requirements

4.1.1 Loadings.

The contractor shall define the longitudinal, lateral, and vertical envelopes of center of gravity and corresponding weights that will exist for each Flight Phase. Throughout these envelopes shall include the most forward and aft center-of-gravity positions as defined in _____. In addition the contractor shall determine the maximum center-of-gravity excursions attainable through failures in systems or components, such as fuel sequencing or hung stores, for each Flight Phase. Throughout these envelopes, plus a growth margin of _____, and for the excursions cited, this standard applies.

4.1.2 Moments and products of inertia.

The contractor shall define the moments and products of inertia of the aircraft associated with all loadings of 4.1.1. The requirements of this standard shall apply for all moments and products of inertia so defined.

4.1.3 Internal and external stores.

The symmetric and asymmetric store combinations to be considered are as follows: _____. The requirements of this standard shall apply to these store conditions. The effects of stores on the weight, moments of inertia, center-of-gravity position, and aerodynamic characteristics of the aircraft shall be determined for each mission Flight Phase. When the stores contain expendable loads, the requirements of this standard apply throughout the range of store loadings, including sloshing/shifting.

4.1.4 Flight Envelopes

4.1.4.1 Operational Flight Envelopes.

The Operational Flight Envelopes define the boundaries in terms of speed, altitude and load factor within which the aircraft must be capable of operating in order to accomplish the missions of 3.1 and in which Level 1 flying qualities are required. These envelopes shall implicitly include the ranges of other parameters, such as sideslip, which may normally be encountered. The range of sideslip or lateral acceleration employed with direct side force control is to be stated explicitly. In the absence of other specific instructions, the contractor shall use the representative conditions of table I for the applicable Flight Phases.

4.1.4.2 Service Flight Envelopes.

For each Aircraft Normal State the contractor shall establish, subject to the approval of the procuring activity, Service Flight Envelopes showing combinations of speed, altitude, and normal acceleration derived from aircraft limits as distinguished from mission requirements. These envelopes shall implicitly include the ranges of other parameters, such as sideslip, which can be expected within the speed, altitude and load-factor bounds. For each applicable Flight Phase and Aircraft Normal State, the boundaries of the Service Flight Envelopes can be coincident with or lie outside the corresponding Operational boundaries.

4.1.4.3 Permissible Flight Envelopes.

The contractor shall define Permissible Flight Envelopes, subject to the approval of the procuring activity, which encompass all regions in which operation of the aircraft is both allowable and possible, and which the aircraft is capable of safely encountering. These Envelopes define boundaries in terms of speed, altitude, load factor and any other flight limits.

4.1.5 Configurations and States of the aircraft.

The requirements of this standard apply for all configurations required or encountered in the applicable Flight Phases of 3.2. A selected configuration is defined by the positions and adjustments of the various selectors and controls available to the crew except for pitch, roll, yaw, throttle and trim controls. Examples are: the flap control setting and the yaw damper ON or OFF. The selected configurations to be examined must include those required for performance demonstration and mission accomplishment. Additional configurations to be investigated are defined as follows: _____. Switches which activate stability augmentation necessary to meet the requirements of this standard are considered always to be ON unless otherwise specified. The State of the aircraft is defined by

MIL-STD-1797A

TABLE I. Operational Flight Envelope.

FLIGHT PHASE CATEGORY	FLIGHT PHASE	AIRSPEED		ALTITUDE		LOAD FACTOR	
A							
B							
C							

the selected configuration together with the functional status of each of the aircraft components or systems, throttle setting, weight, moments of inertia, center-of-gravity position, and external store complement. The trim setting and the positions of the pitch, roll, and yaw controls are not included in the definition of Aircraft State since they are often specified in the requirements.

4.1.6 Aircraft Normal States.

The contractor shall define and tabulate all pertinent items to describe the Aircraft Normal States (no component or system failure) associated with each of the applicable Flight Phases. This tabulation shall be in the format and use the nomenclature of table II. Certain items, such as weight, moments of inertia, center-of-gravity position, wing sweep, or thrust setting may vary continuously over a range of values during a Flight Phase. The contractor shall replace this continuous variation by a limited number of values of the parameter in question which will be treated as specific States, and which include the most critical values and the extremes encountered during the Flight Phase in question.

4.1.6.1 Allowable Levels for Aircraft Normal States.

Flying qualities for Aircraft Normal States within the Operational Flight Envelope shall be Level 1 - Flying qualities for Aircraft Normal States within the Service Flight Envelope but outside the Operational Flight Envelope shall be Level 2 or better. To account for the natural degradation of pilot-vehicle performance and workload in intense atmospheric disturbances, the requirements of 4.1.6.1 through 4.1.6.3 are adjusted according to 4.9.1.

4.1.6.2 Flight outside the Service Flight Envelopes.

From all points in the Permissible Flight Envelopes and outside the Service Flight Envelopes, it shall be possible readily and safely to return to the Service Flight Envelope without exceptional pilot skill or technique. The requirements on flight at high angle of attack, dive characteristics, dive recovery devices and dangerous flight conditions shall also apply in all pertinent parts of the Permissible Flight Envelopes.

4.1.6.3 Ground operation.

Some requirements pertaining to taxiing, takeoffs and landing involve operation outside the Operational, Service, and Permissible Flight Envelopes, as at V_S or on the ground. When requirements are stated at conditions such as these, the Levels shall be applied as if the conditions were in the Operational Flight Envelope.

4.1.7 Aircraft Failure States.

The contractor shall define and tabulate all Aircraft Failure States which can affect flying qualities. Aircraft Failure States consist of Aircraft Normal States modified by one or more malfunctions in aircraft components or systems; for example, a discrepancy between a selected configuration and an actual configuration. Those malfunctions that result in center-of-gravity positions outside the center-of-gravity envelope defined in 4.1.1 shall be included. Each mode of failure shall be considered in all subsequent Flight Phases.

4.1.7.1 Allowable Levels for Aircraft Failure States

4.1.7.2 Aircraft Special Failure States.

Certain components, systems, or combinations thereof may have extremely remote probabilities of failure during a given flight. The failures may, in turn, be very difficult to predict with any degree of accuracy. Special Failure States of this type need not be considered in complying with the requirements of this standard if justification for considering them as Special Failure States is submitted by the contractor and approved by the procuring activity.

4.1.7.3 Probability calculation.

When Aircraft Failure States (4.1.7) exist, a degradation in flying qualities is permitted only if the probability of encountering a lower Level than specified is sufficiently small. The contractor shall determine, based on the most accurate available data, the probability of occurrence of each Aircraft Failure State per flight within the Operational and Service Flight Envelopes. These determinations shall be based on _____ except that:

- a. All aircraft systems are assumed to be operating for the entire flight, unless clearly operative only for a shorter period

MIL-STD-1797A

TABLE II. Aircraft Normal States.

Flight Phase		Weight	C.G.	External Stores	Thrust	Thrust Vector Angle	High Lift Device	Wing Sweep	Wing Incidence	Landing Gear	Speed Brakes	Bomb Bay or Cargo Doors	Stability Augmentation	Other
Takeoff	TO													
Climb	CL													
Cruise	CR													
Loiter	LO													
Descent	D													
Emergency Descent	ED													
Emergency Deceleration	DE													
Approach	PA													
Wave-off/ Go-Around	WO													
Landing	L													
Air-to-Air Combat	CO													
Ground Attack	GA													
Weapon Delivery/ Launch	WD													
Aerial Delivery	AD													
Aerial Recovery	AR													
Reconnaissance	RC													
Refuel Receiver	RR													
Refuel Tanker	RT													
Terrain Following	TF													
Antisubmarine Search	AS													
Close Formation Flying	FF													
Catapult Takeoff	CT													

MIL-STD-1797A

b. For these calculations, the length of flight shall be _____ hours

c. Each specific failure is assumed to be present at whichever point in the Flight Envelope being considered is most critical (in the flying qualities sense).

From these Failure State probabilities and effects, the contractor shall determine the overall probability, per flight, that one or more flying qualities are degraded to Level 2 because of one or more failures. The contractor shall also determine the probability that one or more flying qualities are degraded to Level 3. These probabilities shall be less than the values shown in table III.

TABLE III. Levels for Aircraft Failure States.

PROBABILITY OF ENCOUNTERING	WITHIN OPERATIONAL FLIGHT ENVELOPE	WITHIN SERVICE FLIGHT ENVELOPE
Level 2 after failure	< _____ per flight	
Level 3 after failure	< _____ per flight	< _____ per flight

4.1.7.4 Generic failure analysis.

The requirements on the effects of specific types of failures, for example propulsion or flight control system, shall be met on the basis that the specific type of failure has occurred, regardless of its probability of occurrence. The requirements of this standard on failure transients shall also be met. The allowable flying quality Levels for each of the Failure States in 4.1.7 are defined as follows: _____. In addition, flying qualities in the following specific Failure States shall be as follows:

Failure	Level
_____	_____

4.1.7.5 When Levels are not specified.

Within the Operational and Service Flight Envelopes, all requirements that are not identified with specific Levels shall be met under all conditions of component and system failure except approved Aircraft Special Failure States (4.1.7.2).

4.1.7.6 Failures outside the Service Flight Envelopes.

Failures to be considered outside the Service Flight Envelopes but within the corresponding Permissible Flight Envelopes are _____. After these failures it shall be possible to return safely to the Service and Operational Flight Envelopes.

4.1.8 Dangerous flight conditions.

Dangerous conditions may exist at which the aircraft should not be flown. When approaching these flight conditions, it shall be possible by clearly discernible means for the pilot to recognize the impending dangers and take preventive action. Whenever failures occur that require or limit any flight crew action or decision concerning flying the aircraft, the crew member concerned shall be given immediate and easily interpreted indication.

4.1.8.1 Warning and indication.

Warning and indication of approach to a dangerous condition shall be clear and unambiguous. For example, a pilot must be able to distinguish readily among stall warning (which requires pitching down or increasing speed), Mach buffet (which may indicate a need to decrease speed), and normal aircraft vibration (which indicates no need for pilot action).

4.1.8.2 Devices for indication, warning, prevention, and recovery.

It is intended that dangerous flight conditions be eliminated and the requirements of this standard met by appropriate aerodynamic design and mass distribution, rather than through incorporation of a special device or devices. As a minimum, these devices shall perform their function whenever needed but shall not limit flight within the Operational Flight Envelope. Neither normal nor inadvertent operation of such devices shall create a hazard to the aircraft. For Levels 1 and 2, nuisance operation shall not be possible. Functional failure of the devices shall be indicated to the pilot.

4.1.9 Interpretation of subjective requirements.

In several instances throughout the standard, subjective terms such as objectionable flight characteristics, realistic time delay, normal pilot technique and excessive loss of altitude or buildup of speed, have been employed where insufficient information exists to establish absolute quantitative criteria. Final determination of compliance with requirements so worded will be made by the procuring activity.

4.1.10 Interpretation of quantitative requirements.

Many of the numerical requirements of this standard are stated in terms of a linear mathematical description of classical aircraft. Certain factors, for example flight control system nonlinearities and higher-order dynamics or aerodynamic nonlinearities, can cause an appreciable difference in the aircraft response apparent to the pilot from that of the linear model of the basic airframe. The contractor shall determine equivalent classical systems which have responses most closely matching those of the actual aircraft. Then those numerical requirements of section 4 which are stated in terms of linear system parameters (such as frequency, damping ratio and modal phase angles) apply to the parameters of that equivalent system rather than to any particular modes of the higher-order system representation. The adequacy of the response match between equivalent and actual aircraft, or alternative criteria, shall be agreed upon by the contractor and the procuring activity. Nonlinearities or higher-order dynamics that may exist shall not result in any objectionable (for Levels 1 and 2) or dangerous characteristics.

4.1.11 General flying qualities requirements

4.1.11.1 Buffet.

Within the boundaries of the Operational Flight Envelope, there shall be no objectionable buffet which might detract from the effectiveness of the aircraft in executing its intended missions. In the Permissible Flight Envelope _____.

4.1.11.2 Release of store.

The intentional release or ejection of any stores shall not result in objectionable flight characteristics or impair tactical effectiveness for Levels 1 and 2. However, the intentional release or ejection of stores shall never result in dangerous or intolerable flight characteristics. This requirement applies for all flight conditions and store loadings at which normal or emergency release or ejection of the store is permissible.

4.1.11.3 Effects of armament delivery and special equipment.

Operation of movable parts such as bomb bay doors, cargo doors, armament pods, refueling devices and rescue equipment, or firing of weapons, release of bombs, or delivery or pickup of cargo shall not cause buffet, trim changes, or other characteristics which impair the tactical effectiveness of the aircraft under any pertinent flight condition. These requirements shall be met for Levels 1 and 2.

4.1.11.4 Failures.

No single failure of any component or system shall result in dangerous or intolerable flying qualities; Special Failure States (4.1.7.2) are excepted. The crew member concerned shall be given immediate and easily interpreted indications whenever failures occur that require or limit any flight crew action or decision. The aircraft motions following sudden aircraft system or component failures shall be such that dangerous conditions can be avoided by the pilot, without requiring unusual or abnormal corrective action. A realistic time delay of at least _____ between the failure and initiation of pilot corrective

action shall be incorporated when determining compliance. This time delay shall include an interval between the occurrence of the failure and the occurrence of a cue such as acceleration, rate, displacement, or sound that will definitely indicate to the pilot that a failure has occurred, plus an additional interval which represents the time required for the pilot to diagnose the situation and initiate corrective action.

Additional requirements apply to transients from propulsion system (4.5.8.4, 4.5.9.5.5, 4.6.5.1, 4.6.6.2, 4.6.7.8) and flight control system (4.2.6.1, 4.2.8.6.5, 4.5.7.1, 4.5.9.5.6, 4.6.5.2, 4.6.7.9) failures.

4.1.11.5 Control margin.

Aerodynamic control power, control surface rate and hinge moment capability shall be sufficient to assure safety throughout the combined range of all attainable angles of attack (both positive and negative) and sideslip. This requirement applies to the prevention of loss of control and to recovery from any situation, including deep stall trim conditions, for all maneuvering, including pertinent effects of factors such as pilot strength, regions of control-surface-fixed instability, inertial coupling, fuel slosh, the influence of symmetric and asymmetric stores (4.1.3), stall/post-stall/spin characteristics (4.8.4 through 4.8.4.3.2), atmospheric disturbances (4.9.1) and Aircraft Failure States (4.1.7 through 4.1.7.6); failure transients and maneuvering flight appropriate to the Failure State are to be included. Consideration shall be taken of the degree of effectiveness and certainty of operation of limiters, c.g. control malfunction or mismanagement, and transients from failures in the propulsion, flight control and other relevant systems.

4.1.11.6 Pilot-induced oscillations (PIO).

There shall be no tendency for pilot-induced oscillations, that is, sustained or uncontrollable oscillations resulting from the efforts of the pilot to control the aircraft. More specific requirements are in 4.2.1.2, 4.2.2, 4.5.2 and 4.6.3.

4.1.11.7 Residual oscillations.

Any sustained residual oscillations in calm air shall not interfere with the pilot's ability to perform the tasks required in service use of the aircraft. More specific quantitative requirements are in 4.2.3.

4.1.11.8 Control cross-coupling.

No controller shall create a secondary response which is objectionable (for Levels 1 and 2) or dangerous (for Level 3). This requirement applies to all continuous and discrete controllers which affect the motion of the aircraft.

4.1.12 General flight control system characteristics.

As used in this standard, the term flight control system includes the pitch, roll and yaw controls, direct force controls including leading-edge and trailing-edge flaps, stability augmentation systems, trim selectors and all mechanisms and devices that they operate, including the feel system. The requirements of this section, which are directly related to flying qualities, are in addition to the applicable control system design specification, for example MIL-F-87242 or MIL-C-18244. Some of the important mechanical characteristics of control systems (including servo valves and actuators) are: friction and preload, lost motion, flexibility, mass imbalance and inertia, nonlinear gearing, and rate limiting. Meeting separate requirements on these items, however, will not necessarily ensure that the overall system will be adequate; the mechanical characteristics must be compatible with the nonmechanical portions of the control system and with the airframe dynamic characteristics.

4.1.12.1 Control centering and breakout forces.

Pitch, roll, yaw, direct lift and sideforce controls shall exhibit positive centering in flight at any normal trim setting. Although absolute centering is not required, the combined effects of centering, breakout force, stability and force gradient shall not produce objectionable flight characteristics, such as poor precision-tracking ability, or permit large departures from trim conditions with controls free. Requirements for particular controllers are to be found in 4.2.8.5, 4.3.4, 4.5.9.4 and 4.6.7.11.

4.1.12.2 Cockpit control free play.

The free play in each cockpit control, that is, any motion of the cockpit control which does not move the control surface in flight, shall not result in objectionable flight characteristics, particularly for small-amplitude control inputs.

4.1.12.3 Adjustable controls.

When a cockpit control is adjustable for pilot physical dimensions or comfort, the control forces defined in 3.4.4 refer to the mean adjustment. A force referred to any other adjustment shall not differ by more than 10 percent from the force referred to the mean adjustment.

4.1.12.4 Rate of control displacement.

The ability of the aircraft to perform the operational maneuvers required of it shall not be limited by control surface deflection rates in the atmospheric disturbances specified in 4.9.1. Control rates shall be adequate to retain stabilization and control in the Severe disturbances of those sections. For powered or boosted controls, the effect of engine speed and the duty cycle of both primary and secondary control together with the pilot control techniques shall be included when establishing compliance with this requirement.

4.1.12.5 Dynamic characteristics.

A linear or smoothly varying aircraft response to cockpit-control deflection and to control force shall be provided for all amplitudes of control input. The response of the control surfaces in flight shall not lag the cockpit-control force inputs by more than the angles specified, for frequencies equal to or less than the frequencies specified: _____.

4.1.12.6 Damping.

All control system oscillations apparent to the pilot shall be well damped, unless they are of such an amplitude, frequency and phasing that they do not result in objectionable oscillations of the cockpit controls or the airframe on the ground, during flight and in atmospheric disturbances.

4.1.12.7 Transfer to alternate control modes.

The transient motions and trim changes resulting from the intentional engagement or disengagement of any portion of the flight control system by the pilot shall be such that dangerous flying qualities never result. Allowable transients are further specified in 4.2.6.2, 4.2.8.6.6, 4.5.7.2, 4.5.9.5.7, 4.6.5.3, and 4.6.7.10.

4.1.12.8 Flight control system failures.

The following events shall not cause dangerous or intolerable flying qualities:

- a. Complete or partial loss of any function of the flight control system as a consequence of any single failure (approved Aircraft Special Failure States excepted)
- b. Failure-induced transient motions and trim changes either immediately upon failure or upon subsequent transfer to alternate modes
- c. Configuration changes required or recommended following failure.

The crew member concerned shall be provided with immediate and easily interpreted indication whenever failures occur that require or limit any flight crew action or decision. Allowable transients are specified by axis in 4.2.6.1, 4.5.7.1 and 4.6.5.2.

4.1.12.9 Augmentation systems.

Operation of stability augmentation and control augmentation systems and devices shall not introduce any objectionable flight or ground handling characteristics. Any performance degradation of stability and control augmentation systems due to saturation of components, rate limiting, or surface deflections, shall be only momentary, and shall not introduce any objectionable flight or ground handling characteristics.

This requirement particularly applies for all Normal States and Failure states in the atmospheric disturbances of 4.9.1 and 4.9.2 and during maneuvering flight at the angle-of-attack, sideslip, and load-factor limits of the Permissible Envelope. It also applies to post-stall gyrations, spins, and recoveries with all systems, such as the hydraulic and electrical systems, operating in the state that may result from the gyrations encountered.

4.1.12.10 Auxiliary dive recovery devices.

Operation of any auxiliary device intended solely for dive recovery shall always produce a positive increment of normal acceleration, but the total normal load factor shall never exceed $0.8n_L$, controls free.

4.1.12.11 Direct force controllers.

Direct force controllers include direct lift control systems and lateral translation systems. Direct force controllers which are separate from the attitude controllers shall have a direction of operation consistent with the sense of the aircraft motion produced, be conveniently and accessibly located, comfortable to use and compatible with pilot force and motion capabilities. Transients encountered with engagement of these modes shall meet the requirements of 4.1.12.7, 4.2.6.2, and 4.6.5.3. Functions should be provided in the control system that would only allow this mode to be engaged within its design flight regime or maneuvers. When used either by themselves or in combination with other control modes, flight safety and mission effectiveness shall not be degraded. These systems shall not defeat limiters that are necessary for stable and controlled flight, or for structural considerations.

4.1.13 General trim requirements

4.1.13.1 Trim system irreversibility.

All trimming devices shall maintain a given setting indefinitely unless changed by the pilot, or by a special automatic interconnect (such as to the landing flaps), or by the operation of an augmentation device. If an automatic interconnect or augmentation device is used in conjunction with a trim device, provision shall be made to ensure the accurate return of the device to its initial trim position on removal of each interconnect or augmentation command.

4.1.13.2 Rate of trim operation.

Trim devices shall operate rapidly enough to enable the pilot to maintain low control forces under changing conditions normally encountered in service, yet not so rapidly as to cause oversensitivity or trim precision difficulties under any conditions, including:

- a. Dives and ground attack maneuvers required in normal service operation
- b. Level-flight accelerations at maximum augmented thrust from 250 knots or $V_{R/C}$, whichever is less, to V_{max} at any altitude when the aircraft is trimmed for level flight prior to initiation of the maneuver.

4.1.13.3 Stalling of trim systems.

Stalling of a trim system due to aerodynamic loads during maneuvers shall not result in an unsafe condition. Specifically, the entire trim system shall be capable of operating during the dive recoveries of 4.2.8.6.3 at any attainable permissible n , at any possible position of the trimming device.

4.1.13.4 Transients and trim changes.

The transients and steady-state trim changes for normal operation of control devices such as throttle, thrust reversers, flaps, slats, speed brakes, deceleration devices, dive recovery devices, wing sweep and landing gear shall not impose excessive control forces to maintain the desired heading, altitude, attitude, rate of climb, speed or load factor without use of the trimmer control. This requirement applies to all in-flight configuration changes and combinations of changes made under service conditions, including the effects of asymmetric operations such as unequal operation of landing gear, speed brakes, slats or flaps. In no case shall there be any objectionable buffeting or oscillation caused by such devices. More specific requirements on such control devices are contained in 4.2.5 and 4.1.12.10.

4.1.13.5 Trim for asymmetric thrust.

For all multi-engine aircraft, it shall be possible to trim the cockpit-control forces to zero in straight flight with up to two engines inoperative following asymmetric loss of thrust from the most critical propulsive factors (4.6.5.1). This requirement defines Level 1 in level-flight cruise at speeds from the maximum-range speed for the engine(s)-out configuration to the speed obtainable with normal rated thrust on the functioning engine(s). Systems completely dependent on the failed engines shall also be considered failed.

4.1.13.6 Automatic trim system.

Automatic trimming devices shall not degrade or inhibit the action of response limiters.

4.2 Flying qualities requirements for the pitch axis.

Control force and deflection have both been found universally to be important pilot cues, so both controls-fixed and controls-free (control deflection and force) characteristics have been specified. Although control of the flight path may be the pilot's ultimate aim, pitch attitude control is commonly used as a surrogate.

4.2.1 Pitch attitude dynamic response to pitch controller**4.2.1.1 Long-term pitch response.**

Any oscillation with a period of 15 seconds or longer shall have the following damping: _____. Except as may be provided in 4.4.1, 4.4.1.1 and 4.2.1.2, no aperiodic flight path divergence is allowed within the Service Flight Envelope for any Level of flying qualities. These requirements apply with cockpit controls fixed and with them free.

4.2.1.2 Short-term pitch response

The short-term pitch response shall meet the following requirements for control inputs of all magnitudes that might be experienced in service use: _____

4.2.2 Pilot-induced pitch oscillations.

The pitch attitude response dynamics of the airframe plus control system shall not change abruptly with the motion amplitudes of pitch, pitch rate or normal acceleration unless it can be shown that this will not result in a pilot-induced oscillation. The total phase angle by which normal acceleration measured at the pilot's location lags the pilot's pitch control force input at a criterion frequency, ω_R , shall be less than _____.

4.2.3 Residual pitch oscillations.

In calm air, any sustained residual oscillations shall not interfere with the pilot's ability to perform the tasks required in service use of the aircraft. For Levels 1 and 2, oscillations in normal acceleration at the pilot station greater than _____ will be considered excessive for any Flight Phase. These requirements shall apply with the pitch control fixed and with it free.

4.2.4 Normal acceleration at pilot station.

Normal acceleration at the pilot station due to pitch control inputs shall have the following characteristics: _____

4.2.5 Pitch trim changes.

The pitch trim changes caused by operation of other control devices shall not be so large that a peak pitch control force in excess of 10 pounds for center-stick controllers or 20 pounds for wheel controllers is required when such configuration changes are made in flight under conditions representative of operational procedure. Generally, the conditions of table IV will suffice for determination of compliance with this requirement. With the aircraft trimmed for each specified initial condition, and no retrimming, the peak force required to maintain the specified parameter constant following the specified configuration change shall not exceed the stated value for a time interval of at least 5 seconds following the completion of the pilot action initiating the configuration change. The magnitude and rate of trim change subsequent

MIL-STD-1797A

to this time period shall be easily trimmable by use of the normal trimming devices. These requirements define Level 1. For Levels 2 and 3, the allowable forces are increased by 50 percent _____.

4.2.6 Pitch axis response to other inputs

4.2.6.1 Pitch axis response to failures, controls free.

With controls free, the aircraft motions due to partial or complete failure of any subsystem of the aircraft shall not exceed the following limits for at least _____ seconds following the failure: _____.

4.2.6.2 Pitch axis response to configuration or control mode change.

The transient motions and trim changes resulting from configuration changes or the intentional engagement or disengagement of any portion of the primary flight control system in equilibrium flight due to pilot action shall be such that dangerous flying qualities never result. With controls free, the motion transients resulting from these situations shall not exceed the following limits for at least _____ seconds following the transfer: _____. These requirements apply only for Aircraft Normal States (4.1.6).

TABLE IV. Pitch trim change conditions.

FLIGHT PHASE	INITIAL TRIM CONDITIONS					CONFIGURATION CHANGE	PARAMETER TO BE HELD CONSTANT
	ALTITUDE	SPEED	LANDING GEAR	HIGH-LIFT DEVICES & WING FLAPS	THRUST		

4.2.7 Pitch axis control power**4.2.7.1 Pitch axis control power in unaccelerated flight.**

In steady 1g flight at all Service altitudes, the attainment and holding of all speeds between V_S and V_{max} shall not be limited by the effectiveness of the pitch control.

4.2.7.2 Pitch axis control power in maneuvering flight.

Within the Operational Flight Envelope it shall be possible to develop, by use of the pitch control alone, the following range of load factors: _____. This maneuvering capability is required at constant altitude at the 1g trim speed and, with trim and throttle settings not changed by the Crew, over a range about the trim speed the lesser of 15 percent or 50 kt equivalent airspeed (except where limited by the boundaries of the Operational Flight Envelope).

4.2.7.2.1 Load factor response.

The time required to change from one level of normal load factor to another, in pullups and in turning flight, shall be adequate for all maneuvers appropriate to the Flight Phase, for all conditions within the Service Flight Envelope. Overshoots that result from abrupt pullups into the lift- or control-system-limited region of the load factor boundary shall not result in departure or exceedance of load factor limits.

4.2.7.3 Pitch axis control power in takeoff.

The effectiveness of the pitch control shall not restrict the takeoff performance of the aircraft and shall be sufficient to prevent overrotation during all types of takeoff. It shall be possible to obtain and maintain the following attitudes during the takeoff roll: _____. For catapult takeoffs _____.

4.2.7.4 Pitch axis control power in landing.

The pitch control shall be sufficiently effective in the landing Flight Phase in close proximity to the ground that _____.

4.2.8 Pitch axis control forces**4.2.8.1 Pitch axis control forces--steady-state control force per g.**

These requirements apply for all local gradients throughout the range of Service load factors defined in 4.1.4.2. The term gradient does not include that portion of the force versus n curve within the breakout force.

a. In steady turning flight and in pullups and pushovers at constant speed, the incremental control force required to maintain a change in normal load factor and pitch rate shall be in the same sense (aft--more positive, forward--more negative) as that required to initiate the change.

b. The variations in pitch controller force with steady-state normal acceleration shall have no objectionable nonlinearities within the following load factor range: _____. Outside this range, a departure from linearity resulting in a local gradient which differs from the average gradient for the maneuver by more than 50 percent is considered excessive, except that larger increases in force gradient are permissible at load factors greater than $0.85 n_L$.

c. The local force gradients shall be: _____. In addition, F_S/n should be near the Level 1 upper boundaries of these gradients for combinations of high frequency and low damping.

For all types of controllers, the control force gradients shall produce suitable flying qualities.

4.2.8.2 Pitch axis control forces--transient control force per g.

The buildup of control forces during maneuver entry must not lag the buildup of normal acceleration at the pilot's location. In addition, the frequency response of normal acceleration at the pilot station to pitch control force input shall have the following characteristics: _____.

4.2.8.3 Pitch axis control forces--control force variations during rapid speed changes.

When the aircraft is accelerated and decelerated rapidly through the operational speed range and through the transonic speed range by the most critical combination of changes in power, actuation of deceleration devices, steep turns and pullups, the magnitude and rate of the associated trim change shall not be so great as to cause difficulty in maintaining the desired load factor by normal pilot techniques.

4.2.8.4 Pitch axis control forces--control force vs. control deflection.

The gradient of pitch-control force per unit of incremental pitch-control deflection shall be within the following range: _____. In steady turning flight and in pullups and pushovers at constant speed, the incremental control position shall be in the same sense (aft--more positive, forward--more negative) as that required to initiate the change. Dynamically, throughout the frequency range of pilot control inputs the deflection of the pilot's control must not lead the control force.

4.2.8.5 Pitch axis control breakout forces.

Breakout forces, including friction, preload, etc., shall be within the following limits: _____. These values refer to the cockpit control force required to start movement of the control surface.

4.2.8.6 Pitch axis control force limits**4.2.8.6.1 Pitch axis control force limits--takeoff.**

With the trim setting optional but fixed, the pitch-control forces required during all types of takeoffs for which the aircraft is designed, including short-field takeoffs and assisted takeoffs such as catapult or rocket-augmented, shall be within the following limits: _____. The term takeoff includes the ground run, rotation, and lift-off, the ensuing acceleration to $V_{\max}(\text{TO})$, and the transient caused by assist cessation. Takeoff encompasses operation both in and out of ground effect. Takeoff power shall be maintained until $V_{\max}(\text{TO})$ is reached, with the landing gear and high-lift devices retracted in the normal manner at speeds from $V_{\min}(\text{TO})$ to $V_{\max}(\text{TO})$.

4.2.8.6.2 Pitch axis control force limits—landing.

The pitch control forces for landing shall be less than _____ with the aircraft trimmed for the approach Flight Phase at the recommended approach speed. This limit applies both in and out of ground effect.

4.2.8.6.3 Pitch axis control force limits--dives.

With the aircraft trimmed for level flight at speeds throughout the Service Flight Envelope, the control forces in dives to all attainable speeds within the Service Flight Envelope shall not exceed (a). In similar dives, but with use of trim following the dive entry, it shall be possible with normal piloting techniques to maintain the forces within: (b).

With the aircraft trimmed for level flight at V_{MAT} but with use of trim optional in the dive, it shall be possible to maintain the pitch control force within the following limits in dives to all attainable speeds within the Permissible Flight Envelope (c). The force required for recovery from these dives shall not exceed (d). Trim and deceleration devices, etc., may be used to assist in recovery if no unusual pilot technique is required.

4.2.8.6.4 Pitch axis control force limits-sideslips.

With the aircraft trimmed for straight, level flight with zero sideslip, the pitch-control force required to maintain constant speed in steady sideslips with up to (a) pounds of pedal force in either direction, and in sideslips as specified in the Operational Flight Envelope, shall not exceed the pitch-control force that would result in a 1g change in normal acceleration. In no case, however, shall the pitch-control force exceed (b). If a variation of pitch-control force with sideslip does exist, it is preferred that increasing pull force accompany increasing sideslip, and that the magnitude and direction of the force change be the same for right and left sideslips. For Level 3, throughout the Service Flight Envelope there shall be no uncontrollable pitching motions associated with the sideslip maneuvers discussed above.

4.2.8.6.5 Pitch axis control force limits-failures.

Without retrimming, the change in longitudinal control force required to maintain constant attitude following complete or partial failure of the flight control system shall not exceed the following limits: _____.

4.2.8.6.6 Pitch axis control force limits-control mode change.

Without retrimming, the control force changes resulting from intentional engagement or disengagement of any portion of the primary flight control system by the pilot shall not exceed the following limits: _____.

4.2.8.7 Pitch axis trim systems.

In straight flight, throughout the Operational Flight Envelope the trimming system shall be capable of reducing the steady-state control forces to _____. Pitch trim systems shall not defeat other features incorporated in the flight control system that prevent or suppress departure from controlled flight or exceedance of structural limits, or that provide force cues which warn of approach to flight limits. The failures to be considered in applying Level 2 and 3 requirements shall include trim sticking and runaway in either direction. It is permissible to meet Level 2 and 3 requirements by providing the pilot with alternate trim mechanisms or override capability.

4.2.9 Pitch axis control displacements**4.2.9.1 Pitch axis control displacements-takeoff.**

With the trim setting optional but fixed, the pitch-control travel during all types of takeoffs for which the aircraft is designed shall not exceed _____ percent of the total travel, stop-to-stop. Here the term takeoff includes ground run, rotation and lift-off, the ensuing acceleration to $V_{\max}(\text{TO})$, and any transient caused by assist cessation. Takeoff power shall be maintained until $V_{\max}(\text{TO})$ is reached, with the landing gear and high-lift devices retracted in the normal manner at speeds from $V_{\text{omin}}(\text{TO})$ to $V_{\max}(\text{TO})$. Satisfactory takeoffs, including catapult takeoffs where applicable, shall not depend upon use of the trim controller during takeoff or upon complicated control manipulation by the pilot.

4.2.9.2 Pitch axis control displacements-maneuvering.

For all types of pitch controllers, the control motions in maneuvering flight shall not be so large or so small as to be objectionable. In steady turning flight and in pullups at constant speed, the incremental control deflection required to maintain a change in normal load factor and pitch rate shall be in the same sense (aft-more positive, forward-more negative) as those required to initiate the change.

4.3 Flying qualities requirements for the normal (flight path) axis**4.3.1 Flight path response to attitude change****4.3.1.1 Transient flight path response to attitude change.**

The relation of the flight path response to pitch attitude, for pilot control inputs, shall be as follows:

- a. The short-term flight path response to attitude changes shall have the following characteristics: _____.
- b. If a designated controller other than attitude is the primary means of controlling flight path, the flight path response to an attitude change can be degraded to the following: _____.
- c. In all cases the pitch attitude response must lead the flight path angle by _____ and must have a magnitude equal to or greater than the flight path angle.

4.3.1.2 Steady-state flight path response to attitude change.

For flight path control primarily through the pitch attitude controller, the steady-state path and airspeed response to attitude inputs shall be as follows: _____. For flight control modes using another designated flight path control the required flight path response to attitude changes is _____.

4.3.2 Flight path response to designated flight path controller.

When a designated flight path controller (other than the pitch controller) is used as a primary flight path controller, the short-term flight path response to designated flight path controller inputs shall have the following characteristics: _____. At all flight conditions the pilot-applied force and deflection required to maintain a change in flight path shall be in the same sense as those required to initiate the change.

4.3.3 Flight path control power**4.3.3.1 Control power for designated primary flight path controller.**

If a separate controller (other than the pitch controller) is provided for primary control of direct lift or flight path, it shall be capable of producing the following changes in flight path following full actuation of the controller: _____. This shall be accomplished with pitch attitude held fixed and controls trimmed for an airspeed of _____.

4.3.3.2 Control power for designated secondary flight path controller.

The secondary controller shall be sufficient to produce the following changes in flight path: _____.

4.3.4 Flight path controller characteristics.

The breakout, centering, and force gradient characteristics of the designated flight path controller shall be within the following limits:

Breakout: \pm _____ lb

Centering: \pm _____ % of full travel

Force gradient: _____

4.4 Flying qualities requirements for the longitudinal (speed) axis**4.4.1 Speed response to attitude changes.**

The correlation between airspeed and pitch attitude shall be as follows: (a) _____.

Cockpit controls fixed or free, for Levels 1 and 2 there shall be no tendency for the airspeed to diverge aperiodically when the aircraft pitch attitude is disturbed from trim. For Level 3, the airspeed divergence must be within the following limits: (b) _____.

4.4.1.1 Speed response to attitude changes-relaxation in transonic flight.

The requirements of 4.4.1 may be relaxed in the transonic speed range as follows: _____. This relaxation does not apply to Level 1 for any Flight Phase which requires prolonged transonic operation.

4.5 Flying qualities requirements for the roll axis**4.5.1 Roll response to roll controller****4.5.1.1 Roll mode.**

The equivalent roll mode time constant, T_R , shall be no greater than the following: _____.

4.5.1.2 Spiral stability.

The combined effects of spiral stability, flight control system characteristics and rolling moment change with speed shall be such that following a disturbance in bank of up to 20 degrees, the time to double bank-angle amplitude is no less than _____ seconds. This requirement shall be met with the aircraft trimmed for wings-level, zero-yaw-rate flight and the cockpit controls free.

4.5.1.3 Coupled roll-spiral oscillation.

A coupled roll-spiral mode will be permitted only if it has the following characteristics: _____.

4.5.1.4 Roll oscillations.

With yaw controls free, the response to roll control commands shall meet the following requirements: _____.

4.5.1.5 Roll time delay.

The value of the equivalent time delay, τ_{ep} , shall be no greater than _____.

4.5.2 Pilot-induced roll oscillations.

There shall be no tendency for sustained or uncontrollable roll oscillations resulting from efforts of the pilot to control the aircraft. Specifically, _____.

4.5.3 Linearity of roll response to roll controller.

There shall be no objectionable nonlinearities in the variation of rolling response with roll control deflection or force. Sensitivity or sluggishness in response to small control deflections or force shall be avoided.

4.5.4 Lateral acceleration at the pilot station.

With yaw control free and with it used to coordinate turn entry, the ratio of maximum lateral acceleration at the pilot station to maximum roll rate shall not exceed _____ for the first 2-1/2 seconds following a step roll control input.

4.5.5 Roll characteristics in steady sideslip.

In the straight, steady sideslips of 4.6.1.2:

a. An increase in right bank angle, or no change, shall accompany an increase in right sideslip, and an increase in left bank angle, or no change, shall accompany an increase in left sideslip.

b. Right or zero roll-control deflection and force shall accompany right sideslips, and left or zero roll-control deflection and force shall accompany left sideslips. For Levels 1 and 2, the variation of roll-control deflection and force with sideslip angle shall be essentially linear. This requirement may, if necessary, be excepted for waveoff (go-around) if task performance is not impaired and no more than 50 percent of roll-control power available to the pilot, and no more than 10 pounds of roll-control force, are required in a direction opposite to that specified herein.

4.5.6 Roll axis control for takeoff and landing in crosswinds.

It shall be possible to take off and land with normal pilot skill and technique in the 90-degree crosswinds of 4.6.4.

4.5.7 Roll axis response to other inputs

4.5.7.1 Roll axis response to augmentation failures.

With controls free, for at least _____ seconds following the failure the aircraft motions due to partial or complete failure of the augmentation system shall not exceed the following limits: _____.

4.5.7.2 Roll axis response to configuration or control mode change.

The transient motions and trim changes resulting from configuration changes or the engagement or disengagement of any portion of the primary flight control system shall be such that dangerous flying qualities never result. With controls free, the motion transients resulting from these situations shall not exceed the following limits for at least _____ seconds following the transfer: _____. These requirements apply only for Aircraft Normal States.

4.5.8 Roll axis control power

4.5.8.1 Roll axis response to roll control inputs.

The response to full roll control input shall have the following characteristics: _____. These requirements apply throughout the applicable speed-altitude-load-factor flight envelopes, except that the

structural limits on combined rolling and normal acceleration need not be exceeded. For rolls from steady banked flight, the initial condition shall be coordinated, that is, zero sideslip. The requirements apply to roll commands to the right and to the left, initiated both from steady bank angles and from wings-level, straight flight except as otherwise stated.

Inputs are to be abrupt, with time measured from the initiation of control force. The pitch control is to be held fixed throughout the maneuver. Yaw control pedals shall remain free for Class IV aircraft for Level 1, and for all carrier-based aircraft in Category C Flight Phases for Levels 1 and 2; but otherwise, yaw control pedals may be used to reduce sideslip that retards roll rate (not to produce sideslip that augments roll rate) if such control inputs are simple, easily coordinated with roll control inputs and consistent with piloting techniques for the aircraft Class and mission.

For Flight Phase TO, the time required to bank may be increased proportional to the ratio of the rolling moment of inertia at takeoff to the largest rolling moment of inertia at landing, for weights up to the maximum authorized landing weight.

4.5.8.2 Roll axis control power in steady sideslips.

For Levels 1 and 2, positive effective dihedral (right roll control for right sideslip and left roll control for left sideslip) shall never be so great that more than _____ percent of roll control power available to the pilot is required for sideslips which might be encountered in service deployment.

4.5.8.3 Roll axis control power in crosswinds.

Roll control shall be sufficient to perform the following tasks:

- a. On a dry surface it shall be possible to taxi at any angle to a _____ knot wind
- b. Roll control power, in conjunction with other normal means of control, shall be adequate to maintain a straight path during the takeoff run and the landing rollout in crosswinds up to those specified in 4.6.4.
- c. Roll control power shall be adequate to maintain wings level with up to _____ deg of sideslip in the power approach. For Level 1 this shall require not more than _____ percent of the control power available to the pilot.
- d. Following sudden asymmetric loss of thrust from any factor during takeoff, approach, landing and low-altitude parachute extraction, the aircraft shall be safely controllable in roll in the crosswinds of 4.6.4 from the unfavorable direction.

4.5.8.4 Roll axis control power for asymmetric thrust.

Not more than _____ percent of the roll control available to the pilot shall be needed in meeting the steady-state and dynamic requirements of 4.6.5.1, 4.1.11.4 and 4.6.6.2 for asymmetric loss of thrust from any single factor.

4.5.8.5 Roll axis control power in dives and pullouts.

Roll control power shall be adequate to maintain wings level without retrimming, throughout the dives and pullouts of 4.2.8.6.3.

4.5.8.6 Roll axis control power for asymmetric loading.

When initially trimmed with each asymmetric loading at any speed in the Operational Flight Envelope, and also for hung stores and all asymmetries encountered in normal operation, it shall be possible to maintain a straight flight path throughout the Operational Flight Envelope. For Category A Flight Phases, roll control power with these asymmetric loadings shall be sufficient to hold the wings level at the maximum load factors of 4.2.7.2 with adequate control margin (4.1.11.5).

4.5.9 Roll axis control forces and displacements**4.5.9.1 Roll control displacements.**

For aircraft with wheel controllers, the wheel throw necessary to meet the roll performance requirements specified in 4.5.8 through 4.5.8.6 shall not exceed _____ degrees in either direction. For aircraft with stick controllers, no physical interference with the pilot's body, seat, or cockpit structure shall prevent the pilot from obtaining full control authority.

4.5.9.2 Roll axis control forces to achieve required roll performance.

The roll control force required to obtain the rolling performance specified in 4.5.8.1 shall be neither greater than _____ nor less than _____.

4.5.9.3 Roll axis control sensitivity.

The roll control force gradient shall have the following characteristics: _____. In case of conflict between the requirements of 4.5.9.3 and 4.5.9.2, the requirements of 4.5.9.3 shall govern.

4.5.9.4 Roll axis control centering and breakout forces.

Breakout forces, including friction, preload, etc., shall be within the following limits: _____.

4.5.9.5 Roll axis control force limits**4.5.9.5.1 Roll axis control force limits in steady turns.**

For Levels 1 and 2, with the aircraft trimmed for wings-level, straight flight it shall be possible to maintain steady turns in either direction with the yaw controls free at the following combinations of bank angle and roll controller force characteristics: _____.

4.5.9.5.2 Roll axis control force limits in dives and pullouts.

Roll control forces shall not exceed _____ lb in dives and pullouts to the maximum speeds specified in the Service Flight Envelope.

4.5.9.5.3 Roll axis control force limits in crosswinds.

It shall be possible to take off and land in the crosswinds specified in 4.6.4 without exceeding the following roll control forces: _____.

4.5.9.5.4 Roll axis control force limits in steady sideslips.

For Levels 1 and 2, positive effective dihedral (right roll control for right sideslip and left roll control for left sideslip) shall never be so great that more than _____ pounds of roll-stick force or _____ pounds of roll-wheel force is required for sideslip angles that might be experienced in service employment. In final approach the roll control forces shall not exceed _____ lb when in a straight, steady sideslip of _____ deg.

4.5.9.5.5 Roll axis control force limits for asymmetric thrust.

To meet the steady-state requirements of 4.6.5.1, 4.6.6.2 and 4.1.11.4 shall not require any roll control force greater than _____.

4.5.9.5.6 Roll axis control force limits for failures.

The change in roll control force required to maintain constant attitude following a failure in the flight control system shall not exceed _____ pounds for at least five seconds following the failure.

4.5.9.5.7 Roll axis control force limits for configuration or control mode change.

The control force changes resulting from configuration changes or the intentional engagement or disengagement of any portion of the flight control system shall not exceed the following limits: _____.

4.6 Flying qualities requirements for the yaw axis

4.6.1 Yaw axis response to yaw and side-force controllers

4.6.1.1 Dynamic lateral-directional response.

The equivalent parameters describing the oscillatory response in sideslip, yaw and roll to a yaw control input shall have the following characteristics: _____. These requirements shall be met in trimmed flight with cockpit controls fixed and with them free, and in steady maneuvers, in oscillations of any magnitude that might be experienced in operational use. If the oscillation is nonlinear with amplitude, the requirement shall apply to each cycle of the oscillation.

4.6.1.2 Steady sideslips.

The long-term response to yaw-control-pedal deflections shall have the following characteristics: _____. This requirement applies to yaw-and-roll-control-induced steady, upright, zero-yaw-rate sideslips with the aircraft trimmed for wings-level straight flight, at sideslip angles up to those produced or limited by:

- a. Full yaw-control-pedal deflection, or
- b. 250 pounds of yaw-control-pedal force, or
- c. Maximum roll control or surface deflection,

except that for single-propeller-driven aircraft during waveoff (go-around), yaw-control-pedal deflection in the direction opposite to that required for wings-level straight flight need not be considered beyond the deflection for a 10 deg change in sideslip from the wings-level straight flight condition.

Right yaw-control-pedal force and deflection shall produce left sideslips, and left yaw-control-pedal force and deflection shall produce right sideslips. For Levels 1 and 2 the following requirements shall apply. The variation of sideslip angle with yaw-control-pedal deflection shall be essentially linear for sideslip angles between _____ and _____ degrees. The variation of sideslip angle with yaw-control-pedal force shall be essentially linear for sideslip angles between _____ degrees and _____ degrees. For larger sideslip angles, an increase in yaw-control-pedal force shall always be required for an increase in sideslip.

4.6.1.3 Wings-level turn.

For a wings-level-turn mode of control, the following requirements apply:

- a. Dynamic response to direct force control (DFC) input: The bandwidth of the open-loop response of heading or lateral flight path angle to the DFC input shall be greater than _____ for Flight Phase _____. Turns shall occur at approximately zero sideslip angle and zero or constant small bank angle when using the DFC controller.

- b. Steady-state response to direct force control input: Maximum DFC inputs shall produce at least _____

- c. Direct force control forces and deflections: Use of the primary DFC shall not require use of another control manipulator to meet the above dynamic response requirement. The controller characteristics shall meet the following requirements: _____

- d. Crew acceleration: Abrupt, large DFC inputs shall not produce head or arm motions which interfere with task performance. Crew restraints shall not obstruct the crew's normal field of view nor interfere with manipulation of any cockpit control required for task performance.

4.6.2 Yaw axis response to roll controller.

The sideslip excursions to step roll control inputs shall meet the following criteria: _____. Yaw controls shall be free and, in initial steady turns, fixed at the deflection for zero sideslip in the turn.

4.6.3 Pilot-induced yaw oscillations.

There shall be no tendency for sustained or uncontrollable yaw oscillations resulting from efforts of the pilot to control the aircraft. Specifically, _____.

4.6.4 Yaw axis control for takeoff and landing in crosswinds.

It shall be possible to take off and land with normal pilot skill and technique in 90 deg crosswinds from either side of velocities up to _____.

4.6.5 Yaw axis response to other inputs

4.6.5.1 Yaw axis response to asymmetric thrust.

Asymmetric loss of thrust may be caused by many factors including engine failure, inlet unstart, propeller failure or propeller-drive failure. The requirements apply for the appropriate Flight Phases when any single failure or malperformance of the propulsive system, including inlet, exhaust, engines, propellers, or drives causes loss of thrust on one or more engines or propellers, considering also the effect of the failure or malperformance on all subsystems powered or driven by the failed propulsive system. It shall be possible for the pilot to maintain directional control of the aircraft following a loss of thrust from the most critical propulsive source, allowing a realistic time delay of _____ seconds, as follows:

MIL-STD-1797A

- Takeoff run: During the takeoff run it shall be possible to maintain a straight path on the takeoff surface without deviations of more than _____ feet from the path originally intended, following sudden asymmetric loss of thrust. For the continued takeoff, the requirement shall be met when thrust is lost at speeds from the refusal speed (based on the shortest runway from which the aircraft is designed to operate) to the maximum takeoff speed, with takeoff thrust maintained on the operative engine(s); without depending upon release of the pitch, roll, yaw or throttle controls; and using only controls not dependent upon friction against the takeoff surface. For the aborted takeoff, the requirement shall be met at all speeds below the maximum takeoff speed; however, additional controls such as nose wheel steering and differential braking may be used. Automatic devices that normally operate in the event of a thrust failure may be used in either case.
- Airborne: After lift-off, it shall be possible without a change in selected configuration to achieve straight flight following critical sudden asymmetric loss of thrust at speeds from $V_{min}(TO)$ to $V_{max}(TO)$, and thereafter to maintain straight flight throughout the climbout and to perform 20-degree-banked turns with and against the inoperative propulsive unit. Automatic devices that normally operate in the event of a thrust failure may be used, and for straight flight the aircraft may be banked up to 5 degrees away from the inoperative engine.
- Waveoff/go-around: At any airspeed down to $V_{min}(PA)$ it shall be possible to achieve and maintain steady, straight flight with waveoff (go-around) thrust on the remaining engines following sudden asymmetric loss of thrust from the most critical factor. Configuration changes within the capability of the crew while retaining control of the aircraft, and automatic devices that normally operate in the event of a propulsion failure, may be used.
- Crosswinds: The aircraft response requirements for asymmetric thrust in takeoff and landing apply in the crosswinds of 4.6.4 from the adverse direction.
- General: The static directional stability shall be such that at all speeds above with the critical asymmetric loss of thrust while the other engine(s) develop(s) normal rated thrust, the aircraft with yaw control pedals free may be balanced directionally in steady, straight flight. The trim settings shall be those required for wings-level, straight flight prior to the failure.

4.6.5.2 Yaw axis response to failures.

With controls free, the yawing motions due to failures shall not exceed _____ for at least _____ seconds following the failure.

4.6.5.3 Yaw axis response to configuration or control mode change.

With controls free, the transients resulting from the configuration changes or engagement or disengagement of any portion of the flight control system due to pilot action shall not exceed _____ for at least _____ seconds following the transfer. This requirement applies only for Aircraft Normal States, within the Service Flight Envelope.

4.6.6 Yaw axis control power.

Directional stability and control characteristics shall enable the pilot to balance yawing moments and control yaw and sideslip.

4.6.6.1 Yaw axis control power for takeoff, landing, and taxi.

The following requirements shall be met:

- a. It shall be possible to taxi on a dry surface at any angle to a _____ knot wind.

b. In the takeoff run, landing rollout, and taxi, yaw control power in conjunction with other normal means of control shall be adequate to maintain a straight path on the ground or other landing surface. This applies to calm air and in crosswinds up to the values specified in 4.5.6, on wet runways, and on _____. For very slippery runways, the requirement need not apply for crosswind components at which the force tending to blow the aircraft off the runway exceeds the opposing tire-runway frictional force with the tires supporting all of the aircraft's weight.

c. If compliance with (b) is not demonstrated by test under the adverse runway conditions of (b), directional control shall be maintained by use of aerodynamic controls alone at all airspeeds above _____ kt.

d. Yaw axis control power shall be adequate to develop _____ degrees of sideslip in the power approach.

e. All carrier-based aircraft shall be capable of maintaining a straight path on the ground without the use of wheel brakes, at airspeeds of 30 knots and above, during takeoffs and landings in a 90-degree crosswind of at least $0.1 V_S(L)$.

4.6.6.2 Yaw axis control power for asymmetric thrust.

Yaw control power shall be sufficient to meet the requirements of 4.6.5.1. In addition, at the one-engine-out speed for maximum range with any engine initially failed, upon failure of the most critical remaining engine the yaw control power shall be adequate to stop the transient motion and thereafter to maintain straight flight from that speed to the speed for maximum range with both engines failed. Further, it shall be possible to effect a safe recovery at any service speed above $V_{o_{min}}(CL)$ following sudden simultaneous failure of the two critical engines.

4.6.6.3 Yaw axis control power with asymmetric loading.

Yaw control power shall be sufficient to meet 4.5.8.6.

4.6.7 Yaw axis control forces.

Sensitivity to yaw control pedal forces shall be sufficiently high that directional control and force requirements can be met and satisfactory coordination can be achieved without unduly high control forces, yet sufficiently low that occasional improperly coordinated control inputs will not cause a degradation in flying qualities Level.

4.6.7.1 Yaw axis control force limits in rolling maneuvers.

In the maneuvers described in 4.5.8.1, directional-control effectiveness shall be adequate to maintain zero sideslip with pedal force not greater than _____ lb.

4.6.7.2 Yaw axis control force limits in steady turns.

It shall be possible to maintain steady coordinated turns in either direction, using _____ deg of bank with a pedal force not exceeding _____ lb, with the aircraft trimmed for wings-level, straight flight. These requirements constitute Levels 1 and 2.

4.6.7.3 Yaw axis control force limits during speed changes.

When initially trimmed directionally with symmetric power, the trim change with speed shall be such that wings-level, straight flight can be maintained over a speed range of ± 30 percent of the trim speed or ± 100 kt equivalent airspeed, whichever is less (except where limited by boundaries of the Service Flight Envelope) with yaw-control-pedal forces not greater than _____ lb without retrimming.

4.6.7.4 Yaw axis control force limits in crosswinds.

It shall be possible to take off and land in the crosswinds specified in 4.6.4 without exceeding the following yaw control forces: _____.

4.6.7.5 Yaw axis control force limits with asymmetric loading.

When initially trimmed directionally with each asymmetric loading specified in 4.1.3 at any speed in the Operational Flight Envelope, it shall be possible to maintain a straight flight path throughout the Operational Flight Envelope with yaw-control-pedal forces not greater than _____ lb without retrimming.

4.6.7.6 Yaw axis control force limits in dives and pullouts.

Throughout the dives and pullouts of 4.2.8.6.3, yaw-control-pedal forces shall not exceed _____ lb in dives and pullouts to the maximum speeds in the Service Flight Envelope.

4.6.7.7 Yaw axis control force limits for waveoff (go-around).

The response to thrust, configuration and airspeed change shall be such that the pilot can maintain straight flight during waveoff (go-around) initiated at speeds down to $V_S(PA)$ with yaw control pedal forces not exceeding _____ lb when trimmed to $V_{o_{min}}(PA)$. The preceding requirements apply for Levels 1 and 2. The Level 3 requirement is to maintain straight flight in these conditions with yaw control pedal forces not exceeding _____ lb. Bank angles up to 5 degrees are permitted for all Levels.

4.6.7.8 Yaw axis control force limits for asymmetric thrust during takeoff.

The following requirements shall be met:

Takeoff run: During the takeoff run, to stay within the allowable path deviation of 4.6.5.1, yaw-control forces shall not exceed _____ lb.

Airborne: For the continued takeoff, to achieve straight flight following sudden asymmetric loss of thrust and then maintain straight flight throughout the climbout, as in 4.6.5.1, shall not require a yaw control pedal force greater than _____ lb.

4.6.7.9 Yaw axis control force limits with flight control failures.

The change in yaw control force required to maintain constant attitude following a failure in the flight control system shall not exceed _____ lb for at least 5 seconds following the failure.

4.6.7.10 Yaw axis control force limits-control mode change.

The change in yaw control force required to maintain zero sideslip following configuration changes or engagement or disengagement of any portion of the primary flight control system due to pilot action in stabilized flight shall not exceed the following limits: _____. These requirements apply only for Aircraft Normal States.

4.6.7.11 Yaw axis breakout forces.

Yaw-control breakout forces, including friction, preload, etc., shall be within the following limits: _____. These values refer to the cockpit control force required to start movement of the surface.

4.7 Flying qualities requirements for the lateral flight path axis**4.7.1 Dynamic response for lateral translation.**

The following requirements shall be met:

a. Dynamic response to direct force control input: The bandwidth of the open-loop response of lateral position to lateral translation control input shall be greater than _____ for Flight Phase _____. Lateral translations shall occur at essentially zero bank angle and zero change in heading.

b. Steady-state response to lateral translation control input: Maximum control force input shall produce at least _____ degrees of sideslip.

c. Lateral translation control forces and deflections: Use of the primary lateral translation control shall not require use of another control manipulator to meet requirement a. The controller characteristics shall meet the following requirements: _____.

d. Crew accelerations: Abrupt, large control inputs shall not produce head or arm motions which interfere with task performance. Crew restraints shall not obstruct the crew's normal field of view nor interfere with manipulation of any cockpit control required for task performance.

4.8 Flying qualities requirements for combined axes

4.8.1 Cross-axis coupling in roll maneuvers.

In yaw-control-free maximum-performance rolls through _____ degrees, entered from straight flight or during turns, pushovers, or pullups ranging from 0 g to 0.8 n_L , including simultaneous pitch and roll commands, none of the resulting yaw or pitch motions, or sideslip or angle of attack changes, shall exceed structural limits or cause other dangerous flight conditions such as uncontrollable motions or roll autorotation. Rudder pedal inputs used to roll the aircraft with lateral control fixed, or when used in a coordinated manner with lateral control inputs, shall not result in departures in pitch, roll, or yaw.

During combat-type maneuvers involving rolls through angles up to _____ degrees and rolls which are checked at any given bank angle up to that value, the yawing and pitching shall not be so severe as to impair the tactical effectiveness of the maneuver. These requirements define Level 1 and 2 operation.

4.8.2 Crosstalk between pitch and roll controllers.

The pitch- and roll- control force and displacement sensitivities and breakout forces shall be compatible so that intentional inputs to one control axis will not cause objectionable inputs to the other.

4.8.3 Control harmony.

The following control forces are considered to be limiting values compatible with the pilot's capability to apply simultaneous forces: _____. Larger simultaneous control forces shall not be required to perform any customary and expected maneuvers.

4.8.4 Flight at high angle of attack.

4.8.4 through 4.8.4.3.2 concern stall warning, stalls, departures from controlled flight, post-stall gyrations, spins, recoveries, and related characteristics. They apply at speeds and angles of attack which in general are outside the Service Flight Envelope. They are intended to assure safety and the absence of mission limitations due to high-angle-of-attack flight characteristics.

4.8.4.1 Warning cues.

Warning or indication of approach to stall or loss of aircraft control shall be clear and unambiguous.

4.8.4.2 Stalls.

Stall is defined according to 3.4.2 (V_S) and 3.4.5 (α_S). The stall requirements apply for all Aircraft Normal States in straight unaccelerated flight and in turns and pullups with attainable normal accelerations up to n_L . Specifically to be evaluated are: _____. Also, the requirements apply to Aircraft Failure States that affect stall characteristics.

4.8.4.2.1 Stall approach.

The aircraft shall exhibit the following characteristics in the stall approach:

- a. The onset of warning of stall approach (4.8.4.1) shall occur within the following speed range for 1-g stalls: _____, and within the following range (or percentage) of lift for accelerated stalls: _____, but not within the Operational Flight Envelope.
- b. An increase in intensity of the warning with further increase in angle of attack shall be sufficiently marked to be noted by the pilot. The warning shall continue until the angle of attack is reduced to a value less than that for warning onset. Prior to the stall, uncommanded oscillations shall not _____.
- c. At all angles of attack up to the stall, the cockpit controls shall remain effective in their normal sense, and small control inputs shall not result in departure from controlled flight.
- d. Stall warning shall be easily perceptible and shall consist of _____.

4.8.4.2.2 Stall characteristics.

The following requirements apply for all stalls, including stalls entered abruptly:

MIL-STD-1797A

a. In the unaccelerated stalls of 4.8.4.2, the aircraft shall not exhibit rolling, yawing or downward pitching at the stall which cannot be controlled to stay within _____ deg.

b. It is desired that no pitch-up tendencies occur in stalls, unaccelerated or accelerated. However, in the unaccelerated stalls of 4.8.4.2 mild nose-up pitch may be acceptable if no pitch control force reversal occurs and no dangerous, unrecoverable or objectionable flight conditions result. In the accelerated stalls of 4.8.4.2, a mild nose-up tendency may be acceptable if the operational effectiveness of the aircraft is not compromised and the aircraft has adequate stall warning, pitch control effectiveness is such that it is possible to stop the pitch-up promptly and reduce the angle of attack, and at no point during the stall approach or recovery does any portion of the aircraft exceed structural limit loads.

4.8.4.2.3 Stall prevention and recovery.

The following requirements shall be met:

a. It shall be possible to prevent the stall by moderate use of the pitch control alone at the onset of the stall warning.

b. It shall be possible to recover from a stall by simple use of the pitch, roll and yaw controls with cockpit control forces not to exceed _____, and to regain level flight without excessive loss of altitude or buildup of speed. Throttles shall remain fixed until an angle of attack below the stall has been regained, unless compliance would result in exceeding engine operating limitations.

c. In the straight-flight stalls of 4.8.4.2, with the aircraft trimmed at an airspeed not greater than 1.4 V_s , pitch control power shall be sufficient to recover from any attainable angle of attack.

d. Operation of automatic departure/spin prevention or recovery devices and flight control modes shall not interfere with the pilot's ability to prevent or recover from stalls.

4.8.4.2.4 One-engine-out stalls.

On multi-engine aircraft it shall be possible to recover safely from stalls with the critical engine inoperative. Thrust on the remaining engines shall be at _____.

4.8.4.3 Post-stall gyrations and spins.

The post-stall gyration and spin requirements apply to all modes of motion that can be entered from upsets, decelerations, and extreme maneuvers appropriate to the Class and Flight Phase Category. Entries from inverted flight and tactical entries _____ be included. Entry angles of attack and sideslip up to maximum control capability and under dynamic flight conditions are to be included, except as limited by structural considerations. Thrust settings up to and including MAT shall be included, with and without one critical engine inoperative at entry. The requirements hold for all Aircraft Normal States and for all states of stability and control augmentation systems except approved Special Failure States. Store release shall not be allowed during loss of control, spin or gyration, recovery, or subsequent dive pullout. Automatic disengagement or mode-switching of augmentation systems and automatic flight control system modes, however, is permissible if it is necessary; re-engagement in the normal mode shall be possible in flight following recovery. Specific flight conditions to be evaluated are: _____

4.8.4.3.1 Departure from controlled flight.

The aircraft shall be _____ resistant to departure from controlled flight, post-stall gyrations and spins. Adequate warning of approach to departure (4.8.4.1) shall be provided. The aircraft shall exhibit no uncommanded motion which cannot be arrested promptly by simple application of pilot control. At all angles of attack within the Operational Flight Envelope, following sudden asymmetric loss of thrust from the most critical factor, it shall be possible to avoid departure without exercise of exceptional pilot skill.

4.8.4.3.2 Recovery from post-stall gyrations and spins.

The post-stall characteristics shall be determined. For all aircraft:

a. The proper recovery technique(s) must be readily ascertainable by the pilot and simple and easy to apply under the motions encountered.

MIL-STD-1797A

b. A single technique shall provide prompt recovery from all post-stall gyrations and incipient spins. The same technique, or a compatible one, is required for spin recovery. For all modes of spin that can occur, these recoveries shall be attainable within _____. Avoidance of a spin reversal or an adverse mode change shall not depend upon precise pilot control timing or deflection.

c. Operation of automatic stall/departure/spin prevention devices and flight control modes shall not interfere with or prevent successful recovery of the aircraft by the pilot.

d. Safe and consistent recovery and pullouts shall be accomplished without exceeding the following forces: _____, and without exceeding structural limitations.

4.9 Flying qualities requirements in atmospheric disturbances

4.9.1 Allowable flying qualities degradations in atmospheric disturbances.

Levels and qualitative degrees of suitability of flying qualities as indicated in 3.3 are used to tailor the requirements to abnormal conditions such as flight outside the Operational Flight Envelope and Aircraft Failure States, as well as normal conditions. Abnormalities may also occur in the form of large atmospheric disturbances, or some combination of conditions. For these factors a degradation of flying qualities is permitted as specified herein:

a. In atmospheric disturbances the minimum required flying qualities for Aircraft Normal States are as specified in table V.

b. In atmospheric disturbances the minimum required flying qualities for Aircraft Failure States are as specified in table VI.

TABLE V. Flying qualities in atmospheric disturbances for Aircraft Normal States.

ATMOSPHERIC DISTURBANCES	WITHIN OPERATIONAL FLIGHT ENVELOPE	WITHIN SERVICE FLIGHT ENVELOPE
LIGHT TO CALM	_____	_____
MODERATE TO LIGHT	_____	_____
SEVERE TO MODERATE	_____	_____

TABLE VI. Flying qualities in atmospheric disturbances for Aircraft Failure States.

ATMOSPHERIC DISTURBANCES	FAILURE STATE I*	FAILURE STATE II*
LIGHT TO CALM		
MODERATE TO LIGHT		
SEVERE TO MODERATE		

* Failure State I: _____

** Failure State II: _____

For this purpose atmospheric disturbances are defined separately for high (above approximately 1750 ft) and low altitudes: _____.

Crosswind intensities at touchdown are defined as: _____.

Required wind-shear capability is: _____.

4.9.2 Definition of atmospheric disturbance model form.

When compliance is to be shown using piloted simulation, an atmospheric disturbance model appropriate to the piloting task shall be included. As a minimum, the atmospheric disturbance model shall consist of _____.

4.9.3 Application of disturbance models in analyses.

The gust and turbulence velocities shall be applied to the aircraft equations of motion through the aerodynamic terms only, and the direct effect on the aerodynamic sensors shall be included when such sensors are part of the aircraft augmentation system. Application of the disturbance model depends on the motion variables and the range of frequencies of concern in the analysis. When structural modes are within or close to this range, the exact distribution of turbulence velocities must be considered. For this purpose it is acceptable to consider u_g and v_g as being one-dimensional for the evaluation of aerodynamic forces and moments. The w_g should be considered two-dimensional, a function of both x and y .

When structural modes are not significant to the analysis or simulation, airframe rigid-body responses may be evaluated by considering uniform gust or turbulence immersion along with linear gradients of the disturbance velocities. The uniform immersion is accounted for by u_g , v_g , w_g defined at the aircraft center of gravity. The angular velocities due to turbulence are equivalent in effect to aircraft angular velocities. Approximations for these angular velocities are defined (precise only at very low frequencies) as follows:

$$-\dot{\alpha}_g = q_g = \frac{\partial w_g}{\partial x}, \quad p_g = \frac{-\partial w_g}{\partial y}, \quad r_g = \frac{-\partial v_g}{\partial x}$$

For altitudes below 1750 ft, the turbulence velocity components u_g , v_g , and w_g are to be taken along axes corresponding to u_g aligned along the horizontal relative mean wind vector and w_g vertical.

5. VERIFICATION

5.1 General requirements-verification

5.1.1 Loadings-verification.

The contractor shall furnish the required loading data in accordance with the Contract Data Requirements List.

5.1.2 Moments and products of inertia-verification.

The contractor shall furnish moments and products of inertia data in accordance with the Contract Data Requirements List.

5.1.3 Internal and external stores-verification.

The analysis, simulation, and testing to verify compliance with this standard shall include the listed stores. The contractor shall furnish a list of store restrictions in accordance with the Contract Data Requirements List.

5.1.4 Flight Envelopes-verification

5.1.4.1 Operational Flight Envelopes-verification.

The contractor shall submit the Operational Flight Envelopes for approval by the procuring activity in accordance with the Contract Data Requirements List.

5.1.4.2 Service Flight Envelopes-verification.

The contractor shall submit the required data for approval by the procuring activity in accordance with the Contract Data Requirements List.

5.1.4.3 Permissible Flight Envelopes-verification.

The contractor shall provide the required data for approval of the procuring activity in accordance with the Contract Data Requirements List.

5.1.5 Configurations and States of the aircraft-verification.

The contractor shall furnish a list of aircraft configurations in accordance with the Contract Data Requirements List.

5.1.6 Aircraft Normal States-verification.

The contractor shall furnish a list of Aircraft Normal States in accordance with the Contract Data Requirements List.

5.1.6.1 Allowable Levels for Aircraft Normal States-verification.

Verification shall be by analysis, simulation and test.

5.1.6.2 Flight outside the Service Flight Envelopes-verification.

Verification shall be by analysis, simulation and test.

5.1.6.3 Ground operation-verification.

Verification shall be by analysis, simulation and test.

5.1.7 Aircraft Failure States-verification.

The contractor shall furnish the required data in accordance with the Contract Data Requirements List.

5.1.7.1 Allowable Levels for Aircraft Failure States-verification

5.1.7.2 Aircraft Special Failure States-verification.

The contractor shall submit the required data in accordance with the Contract Data Requirement List, for review by the procuring activity.

5.1.7.3 Probability calculation-verification.

The contractor shall submit the required data in accordance with the Contract Data Requirements List.

5.1.7.4 Generic failure analysis-verification.

The contractor shall submit the required data in accordance with the Contract Data Requirements List.

5.1.7.5 When Levels are not specified-verification.

Verification shall be by analysis, simulation and flight test.

5.1.7.6 Failures outside the Service Flight Envelopes-verification.

The contractor shall review the list furnished by the procuring activity and through its own analysis modify and extend that list as necessary for adequate coverage of flying qualities degradations, subject to procuring activity approval, in accordance with the Contract Data Requirements List. Verification of safe return capability shall be by analysis, simulation, and flight test.

5.1.8 Dangerous flight conditions-verification.

Verification shall be by analysis, simulation, and ground and flight testing.

5.1.8.1 Warning and indication-verification.

Verification shall be by analysis, simulation, and ground and flight testing.

5.1.8.2 Devices for indication, warning, prevention, and recovery-verification.

Verification shall be by analysis, simulation, and ground and flight testing.

5.1.9 Interpretation of subjective requirements-verification.

Verification shall be by analysis, simulation and test.

5.1.10 Interpretation of quantitative requirements-verification.

Verification shall be by analysis, simulation and test.

5.1.11 General flying qualities requirements-verification

5.1.11.1 Buffet-verification.

Verification shall be by analysis, simulation and test.

5.1.11.2 Release of stores-verification.

Verification shall be by analysis, simulation and test.

5.1.11.3 Effects or armament delivery and special equipment-verification.

Verification shall be by analysis, simulation and flight test.

5.1.11.4 Failures-verification.

Verification shall be by analysis, simulation and test.

5.1.11.5 Control margin-verification.

Verification shall be by analysis, simulation, and ground and flight test.

5.1.11.6 Pilot-induced oscillations(PIO)-verification.

Verification shall be by analysis, simulation and flight test.

5.1.11.7 Residual oscillations-verification.

Verification shall be by analysis, simulation and flight test.

5.1.11.8 Control cross-coupling-verification.

Verification shall be by analysis, simulation and flight test.

5.1.12 General flight control system characteristics-verification.

Verification shall be by analysis and flight test.

5.1.12.1 Control centering and breakout forces-verification.

Verification shall be by analysis and test. Measurement of breakout forces on the ground will ordinarily suffice in lieu of actual flight measurement, provided that qualitative agreement between ground measurement and flight measurement can be established.

5.1.12.2 Cockpit control free play-verification.

Verification shall be by analysis and flight test.

5.1.12.3 Adjustable controls-verification.

Verification shall be by inspection.

5.1.12.4 Rate of control displacement-verification.

Verification shall be by analysis, simulation and flight test.

5.1.12.5 Dynamic characteristics-verification.

Verification shall be by analysis and test.

5.1.12.6 Damping-verification.

Verification shall be by analysis and flight test.

5.1.12.7 Transfer to alternate control modes-verification.

Verification shall be by analysis and flight test.

5.1.12.8 Flight control system failures-verification.

Verification shall be by analysis, simulation and flight test.

5.1.12.9 Augmentation systems-verification.

Verification shall be by analysis, simulation and flight test.

5.1.12.10 Auxiliary dive recovery devices-verification.

Verification shall be by analysis, simulation and flight test.

5.1.12.11 Direct force controllers-verification.

Verification shall be by analysis, simulation, inspection, and flight test.

5.1.13 General trim requirements-verification

5.1.13.1 Trim system irreversibility-verification.

Verification shall be by analysis and test.

5.1.13.2 Rate of trim operation-verification.

Verification shall be by analysis, simulation and flight test.

5.1.13.3 Stalling of trim systems-verification.

Verification shall be by analysis and flight test.

5.1.13.4 Transients and trim changes-verification.

Verification shall be by analysis, simulation and flight test.

5.1.13.5 Trim for asymmetric thrust-verification.

Verification shall be by analysis, simulation and flight test.

5.1.13.6 Automatic trim system-verification.

Verification shall be by analysis, simulation and flight test.

5.2 Flying qualities requirements for the pitch axis-verification

5.2.1 Pitch attitude dynamic response to pitch controller-verification

5.2.1.1 Long-term pitch response-verification.

Verification shall be by analysis, simulation and flight test.

5.2.1.2 Short-term pitch response-verification.

Verification shall be by analysis, simulation and flight test.

5.2.2 Pilot-induced pitch oscillations-verification.

Verification shall be by analysis, simulation and flight test.

5.2.3 Residual pitch oscillations-verification.

Verification shall be by analysis, simulation and flight test.

5.2.4 Normal acceleration at pilot station-verification.

Verification shall be by analysis, simulation and flight test.

5.2.5 Pitch trim changes-verification.

Verification shall be by analysis, simulation and flight test.

5.2.6 Pitch axis response to other inputs-verification

5.2.6.1 Pitch axis response to failures, controls free-verification.

Verification shall be by analysis, simulation and flight test.

5.2.6.2 Pitch axis response to configuration or control mode change-verification.

Verification shall be by analysis, simulation and flight test.

5.2.7 Pitch axis control power-verification

5.2.7.1 Pitch axis control power in unaccelerated flight-verification.

Verification shall be by analysis, simulation and flight test.

5.2.7.2 Pitch axis control power in maneuvering flight-verification.

Verification shall be by analysis, simulation and flight test.

5.2.7.2.1 Load factor response-verification.

Verification shall be by analysis, simulation and flight test.

5.2.7.3 Pitch axis control power in takeoff-verification.

Verification shall be by analysis, simulation and flight test.

5.2.7.4 Pitch axis control power in landing-verification.

Verification shall be by analysis, simulation and flight test.

5.2.8 Pitch axis control forces-verification

5.2.8.1 Pitch axis control forces-steady-state control force per g-verification.

Verification shall be by analysis, simulation and flight test.

5.2.8.2 Pitch axis control forces-transient control force per g-verification.

Verification shall be by analysis, simulation and flight test.

5.2.8.3 Pitch axis control forces-control force variations during rapid speed changes-verification.

Verification shall be by analysis, simulation and flight test.

5.2.8.4 Pitch axis control forces-control force vs. control deflection-verification.

Verification shall be by analysis, simulation and flight test.

5.2.8.5 Pitch axis control breakout forces-verification.

Verification shall be by analysis, simulation and test.

5.2.8.6 Pitch axis control force limits-verification

5.2.8.6.1 Pitch axis control force limits-takeoff-verification.

Verification shall be by analysis, simulation and flight test.

5.2.8.7 Pitch axis control force limits-landing-verification.

Verification shall be by analysis, simulation and flight test.

5.2.8.7.1 Pitch axis control force limits-dives-verification.

Verification shall be by analysis, simulation and flight test.

5.2.8.7.2 Pitch axis control force limits-sideslips-verification.

Verification shall be by analysis, simulation and flight test.

5.2.8.7.3 Pitch axis control force limits-failures-verification.

Verification shall be by analysis, simulation and flight test.

5.2.8.7.4 Pitch axis control force limits-control mode change-verification.

Verification shall be by analysis, simulation and flight test.

5.2.8.8 Pitch axis trim systems-verification.

Verification shall be by analysis, simulation and flight test.

5.2.9 Pitch axis control displacements-verification

5.2.9.1 Pitch axis control displacements-takeoff-verification.

Verification shall be by analysis, simulation and flight test.

5.2.9.2 Pitch axis control displacements-maneuvering-verification.

Verification shall be by analysis, simulation and flight test.

5.3 Flying qualities requirements for the normal (flight path) axis-verification

5.3.1 Flight path response to attitude change-verification

5.3.1.1 Transient flight path response to attitude change-verification.

Verification shall be by analysis, simulation and flight test.

5.3.1.2 Steady-state flight path response to attitude change-verification.

Verification shall be by analysis, simulation and flight test.

5.3.2 Flight path response to designated flight path controller-verification.

Verification shall be by analysis, simulation and flight test.

5.3.3 Flight path control power-verification

5.3.3.1 Control power for designated primary flight path controller-verification.

Verification shall be by analysis, simulation and flight test.

5.3.3.2 Control power for designated secondary flight path controller-verification.

Verification shall be by analysis, simulation and flight test.

5.3.4 Flight path controller characteristics-verification.

Verification shall be by analysis, simulation and test.

5.4 Flying qualities requirements for the longitudinal (speed) axis-verification

5.4.1 Speed response to attitude changes-verification.

Verification shall be by analysis, simulation and flight test.

5.4.1.1 Speed response to attitude changes-relaxation in transonic flight-verification.

Verification shall be by analysis, simulation and flight test.

5.5 Flying qualities requirements for the roll axis-verification

5.5.1 Roll response to roll controller-verification

5.5.1.1 Roll mode-verification.

Verification shall be by analysis, simulation and flight test.

5.5.1.2 Spiral stability-verification.

Verification shall be by analysis, simulation and flight test.

5.5.1.3 Coupled roll-spiral oscillation-verification.

Verification shall be by analysis, simulation and flight test.

5.5.1.4 Roll oscillations-verification.

Verification shall be by analysis, simulation and flight test.

5.5.1.5 Roll time delay-verification.

Verification shall be by analysis, simulation and flight test.

5.5.2 Pilot-induced roll oscillations-verification.

Verification shall be by analysis, simulation and flight test.

5.5.3 Linearity of roll response to roll controller-verification.

Verification shall be by analysis, simulation and flight test.

5.5.4 Lateral acceleration at the pilot station-verification.

Verification shall be by analysis, simulation and flight test.

5.5.5 Roll characteristics in steady sideslip-verification.

Verification shall be by analysis, simulation and flight test.

5.5.6 Roll axis control for takeoff and landing in crosswinds-verification.

Verification shall be by analysis, simulation and flight test.

5.5.7 Roll axis response to other inputs-verification

5.5.7.1 Roll axis response to augmentation failures-verification.

Verification shall be by analysis, simulation and flight test.

5.5.7.2 Roll axis response to configuration or control mode change-verification.

Verification shall be by analysis, simulation and flight test.

5.5.8 Roll axis control power-verification

5.5.8.1 Roll axis response to roll control inputs-verification.

Verification shall be by analysis, simulation and flight test.

5.5.8.2 Roll axis control power in steady sideslips-verification.

Verification shall be by analysis, simulation and flight test.

5.5.8.3 Roll axis control power in crosswinds-verification.

Verification shall be by analysis, simulation and ground and flight test.

5.5.8.4 Roll axis control power for asymmetric thrust-verification.

Verification shall be by analysis, simulation and flight test.

5.5.8.5 Roll axis control power in dives and pullouts-verification.

Verification shall be by analysis, simulation and flight test.

5.5.8.6 Roll axis control power for asymmetric loading-verification.

Verification shall be by analysis, simulation and flight test.

5.5.9 Roll axis control forces and displacements-verification

5.5.9.1 Roll control displacements-verification.

Verification shall be by inspection or flight test.

5.5.9.2 Roll axis control forces to achieve required roll performance-verification.

Verification shall be by analysis, simulation and flight test.

5.5.9.3 Roll axis control sensitivity-verification.

Verification shall be by analysis, simulation and flight test.

5.5.9.4 Roll axis control centering and breakout forces-verification.

Verification shall be by analysis, simulation and flight test.

5.5.9.5 Roll axis control force limits-verification

5.5.9.5.1 Roll axis control force limits in steady turns-verification.

Verification shall be by analysis, simulation and flight test.

5.5.9.5.2 Roll axis control force limits in dives and pullouts-verification.

Verification shall be by analysis, simulation and flight test.

5.5.9.5.3 Roll axis control force limits in crosswinds-verification.

Verification shall be by analysis, simulation and flight test.

5.5.9.5.4 Roll axis control force limits in steady sideslips-verification.

Verification shall be by analysis, simulation and flight test.

5.5.9.5.5 Roll axis control force limits for asymmetric thrust-verification.

Verification shall be by analysis, simulation and flight test.

5.5.9.5.6 Roll axis control force limits for failures-verification.

Verification shall be by analysis, simulation and flight test.

5.5.9.5.7 Roll axis control force limits for configuration or control mode change-verification.

Verification shall be by analysis, simulation and flight test.

5.6 Flying qualities requirements for the yaw axis-verification

5.6.1 Yaw axis response to yaw and side-force controllers-verification

5.6.1.1 Dynamic lateral-directional response-verification.

Verification shall be by analysis, simulation and flight test.

5.6.1.2 Steady sideslips-verification.

Verification shall be by analysis, simulation and flight test.

5.6.1.3 Wings-level turn-verification.

Verification shall be by analysis, simulation and flight test.

5.6.2 Yaw axis response to roll controller-verification.

Verification shall be by analysis, simulation and flight test.

5.6.3 Pilot-induced yaw oscillations-verification.

Verification shall be by analysis, simulation and flight test.

5.6.4 Yaw axis control for takeoff and landing in crosswinds-verification.

Verification shall be by analysis, simulation and flight test.

5.6.5 Yaw axis response to other inputs-verification

5.6.5.1 Yaw axis response to asymmetric thrust-verification.

Verification shall be by analysis, simulation and flight test.

5.6.5.2 Yaw axis response to failures-verification.

Verification shall be by analysis, simulation and flight test.

5.6.5.3 Yaw axis response to configuration or control mode change-verification.

Verification shall be by analysis, simulation and flight test.

5.6.6 Yaw axis control power-verification.

Verification shall be by analysis, simulation and flight test.

5.6.6.1 Yaw axis control power for takeoff, landing, and taxi-verification.

Verification shall be by analysis, simulation and flight test.

5.6.6.2 Yaw axis control power for asymmetric thrust-verification.

Verification shall be by analysis, simulation and flight test.

5.6.6.3 Yaw axis control power with asymmetric loading-verification.

Verification shall be by analysis, simulation and flight test.

5.6.7 Yaw axis control forces-verification.

Verification shall be by analysis, simulation and flight test.

5.6.7.1 Yaw axis control force limits in rolling maneuvers-verification.

Verification shall be by analysis, simulation and flight test.

5.6.7.2 Yaw axis control force limits in steady turns-verification.

Verification shall be by analysis, simulation and flight test.

5.6.7.3 Yaw axis control force limits during speed changes-verification.

Verification shall be by analysis, simulation and flight test.

5.6.7.4 Yaw axis control force limits in crosswinds-verification.

Verification shall be by analysis, simulation and flight test.

5.6.7.5 Yaw axis control force limits with asymmetric loading-verification.

Verification shall be by analysis, simulation and flight test.

5.6.7.6 Yaw axis control force limits in dives and pullouts-verification.

Verification shall be by analysis, simulation and flight test.

5.6.7.7 Yaw axis control force limits for waveoff (go-around)-verification.

Verification shall be by analysis, simulation and flight test.

5.6.7.8 Yaw axis control force limits for asymmetric thrust during takeoff-verification.

Verification shall be by analysis, simulation and flight test.

5.6.7.9 Yaw axis control force limits with flight control failures-verification.

Verification shall be by analysis, simulation and flight test.

5.6.7.10 Yaw axis control force limits-control mode change-verification.

Verification shall be by analysis, simulation and flight test.

5.6.7.11 Yaw axis breakout forces-verification.

Verification shall be by test.

5.7 Flying qualities requirements for the lateral flight path axis-verification

5.7.1 Dynamic response for lateral translation-verification.

Verification shall be by analysis, simulation and flight test.

5.8 Flying qualities requirements for combined axes-verification

5.8.1 Cross-axis coupling in roll maneuvers-verification.

Verification shall be by analysis, simulation and flight test.

5.8.2 Crosstalk between pitch and roll controllers-verification.

Verification shall be by analysis, simulation and flight test.

5.8.3 Control harmony-verification.

Verification shall be by analysis, simulation and flight test.

5.8.4 Flight at high angle of attack-verification

5.8.4.1 Warning cues-verification.

Verification shall be by analysis, simulation and flight test.

5.8.4.2 Stalls-verification.

Verification shall be by analysis, simulation and flight test.

5.8.4.2.1 Stall approach-verification.

Verification shall be by analysis, simulation and flight test.

5.8.4.2.2 Stall characteristics-verification.

Verification shall be by analysis, simulation and flight test.

5.8.4.2.3 Stall prevention and recovery-verification.

Verification shall be by analysis, simulation and flight test.

5.8.4.2.4 One-engine-out stalls-verification.

Verification shall be by analysis, simulation and flight test.

5.8.4.3 Post-stall gyrations and spins-verification.

Verification shall be by analysis, simulation and flight test.

5.8.4.3.1 Departure from controlled flight-verification.

Verification shall be by analysis, simulation and _____.

5.8.4.3.2 Recovery from post-stall gyrations and spins-verification.

Verification shall be by analysis, simulation and _____.

5.9 Flying qualities requirements in atmospheric disturbances-verification

5.9.1 Allowable flying qualities degradations in atmospheric disturbances-verification.

Verification shall be by analysis, simulation and flight test.

5.9.2 Definition of atmospheric disturbance model form-verification.

Verification shall be by analysis and simulation.

5.9.3 Application of disturbance models in analyses-verification.

Verification shall be by analysis and simulation.

6. NOTES

This section contains information of a general or explanatory nature that may be helpful, but is not mandatory.

6.1 Intended use.

This standard contains the handling qualities requirements for piloted aircraft and forms one of the bases for determination by the procuring activity of aircraft acceptability. The standard consists of requirements in terms of criteria for use in stability and control calculations, analysis of wind tunnel test results, simulator evaluations, flight testing, etc. The requirements should be met as far as possible by providing an inherently good basic airframe. Cost, performance, reliability, maintenance, etc. trade-offs are necessary in determining the proper balance between basic airframe characteristics and augmented dynamic response characteristics. The contractor should advise the procuring activity of any significant design penalties which may result from meeting any particular requirement.

6.2 Level definitions.

Part of the intent of 4.1.7.3 and 4.9.1 is to ensure that the probability of encountering significantly degraded flying qualities because of component or subsystem failures is small. For example, the probability of encountering very degraded flying qualities (Level 3) must be less than specified values per flight. To determine the degradation in flying qualities parameters for a given Aircraft Normal State the following definitions are provided:

- a. Level 1 is better than or equal to the Level 1 boundary, or number, specified in section 4.
- b. Level 2 is worse than Level 1, but no worse than the Level 2 boundary, or number
- c. Level 3 is worse than Level 2, but no worse than the Level 3 boundary, or number.

When a given boundary, or number, is identified as Level 1 and Level 2, this means that flying qualities outside the boundary conditions shown, or worse than the number given, are at best Level 3 flying qualities. Also, since Level 1 and Level 2 requirements are the same, flying qualities for Aircraft Normal States must be within this common boundary, or number, in both the Operational and Service Flight Envelopes (4.1.6.1). Aircraft Failure States that do not degrade flying qualities beyond this common boundary are not considered in meeting the requirements of 4.1.7.3. Aircraft Failure States that represent degradations to Level 3 must, however, be included in the computation of the probability of encountering Level 3 degradations in both the Operational and Service Flight Envelopes. Again, degradation beyond the Level 3 boundary is not permitted regardless of component failures.

6.3 Reference documents tree.

The following list of documents comprises the 1st and 2nd tier references. Only 1st tier references are contractually binding; 2nd tier is for guidance only.

MIL-STD-1797A

1st Tier References	2nd Tier References
<p>MIL-C-18244, Control and Stabilization Systems</p>	<p>JAN-1-225 Interference Measurements JAN-T-781 Terminal; Cable MIL-F-3541 Fittings, Lubrication MIL-S-3950 Switches, Toggle MIL-E-4682 Electron Tubes MIL-W-5088 Wiring, Aircraft MIL-E-5272 Environmental Testing MIL-E-5400 Electronic Equipment MIL-H-5440 Hydraulic System MIL-I-6115 Instrument Systems MIL-1-6181 Interference Control MIL-L-6880 Lubrication of Aircraft MIL-E-7080 Electrical Equipment MIL-M-7969 Motors, Alternating MIL-A-8064 Actuators and Act Systems MIL-M-7793 Meter, Time Totaling MIL-H-8501 Helicopter Flying Qual. MIL-S-8512 Support Equipment, Aeron MIL-M-8609 Motors, Direct Current MIL-D-8706 Data, Design MIL-F-8785 Flying Qualities MIL-D-18300 Design Data Requirements MIL-N-18307 Nomenclature/Nameplates MIL-E-19600 Electronic Modules MIL-R-22256 Reliability Requirements MIL-F-23094 Reliability Assurance MIL-STD-203 Cockpit Controls MIL-STD-704 Electnc Power MS15001 Fittings, Lubrication MS 15002 Fittings, Lubrication</p>
<p>MIL-F-87242, Flight Controls</p>	

6.4 Data requirements.

When this standard is used in an acquisition which incorporates a DD Form 1423, Contract Data Requirement List (CDRL), the data requirements identified below shall be developed as specified by an approved Data Item Description (DD Form 1664) and delivered in accordance with the approved CDRL incorporated into the contract. When the provisions of the DoD FAR clause on data requirements

MIL-STD-1797A

(currently DoD FAR Supplement 52-227-7031) are invoked and the DD Form 1423 is not used, the data specified below shall be delivered by the contractor in accordance with the contract or purchase order requirements. Deliverable data required by this standard is cited in the following paragraphs.

Paragraph No.	Data Requirement Title	Applicable DID No.	Option
---------------	------------------------	--------------------	--------

(Data item descriptions related to this standard, and identified in section 6 will be approved and listed as such in DoD 5000.19-L, Vol. II, AMSDL. Copies of data item descriptions required by the contractors in connection with specific acquisition functions should be obtained from the Naval Publications and Forms Center or as directed by the contracting officer.)

6.5 Subject term (key word) listing

Aircraft
Airplane design criteria
Design criteria
Handling qualities
Pilot vehicle interface

6.6 Responsible engineering office (REO).

The office responsible for development and technical maintenance of this standard is ASD/ENFTC, Wright-Patterson AFB, OH 45433-6503; AUTOVON 785-5730, Commercial (513) 255-5730. Any information relating to Government contracts must be obtained through contracting officers.

6.7 Changes from previous issue.

Marginal notations are not used in this revision to identify changes with respect to the previous issue due to the extensiveness of the changes.

Custodians:
Army - AV
Navy - AS
Air Force - 11

Preparing activity
Air Force - 11

Project No 15GP-0088

APPENDIX A
FLYING QUALITIES OF PILOTED AIRCRAFT
HANDBOOK FOR

10. SCOPE

10.1 Scope.

This appendix provides rationale, guidance, lessons learned, and instructions necessary, to tailor sections 4 and 5 of the basic standard (MIL-STD-1797A) for a specific application.

10.2 Purpose.

This appendix provides information to assist the Government procuring activity in the use of MIL-STD-1797A.

10.3 Use.

This appendix is designed to assist the project engineer in tailoring MIL-STD-1797A. The blanks of the basic standard shall be filled in to meet operational needs of the tailored application

10.4 Format

10.4.1 Requirement/verification identity.

Section 40 of this appendix parallels section 4 and section 5 of the basic standard; paragraph titles and numbering are in the same sequence. Section 40 provides each requirement (section 4) and associated verification (section 5) as stated in the basic standard. Both the requirement and verification have sections for rationale, guidance, and lessons learned.

10.4.2 Requirement/verification package.

Section 40 of this appendix has been arranged so that the requirement and associated verification is a complete package to permit addition to, or deletion from, the criteria as a single requirement. A requirement is not specified without an associated verification.

10.5 Responsible engineering office.

The responsible engineering office (REO) for this appendix is ASD/ENFTC, Wright-Patterson AFB OH 45433-6503; AUTOVON 785-5730, Commercial (513)-255-5730.

20. APPLICABLE DOCUMENTS

20.1 References.

The documents referenced in this appendix are not intended to be applied contractually. Their primary purpose is to provide background information for the Government engineers responsible for developing the most appropriate performance values (filling in the blanks) for the requirements contained in the standard proper.

20.2 Avoidance of tiering.

Should it be determined that the references contained in this appendix are necessary in writing an RFP or building a contract, excessive tiering shall be avoided by calling out only those portions of the reference which have direct applicability. It is a goal of the Department of Defense that the practice of referencing documents in their entirety be eliminated in order to reduce the tiering effect.

20.3 Government documents

SPECIFICATIONS

MIL-STD-1797A
APPENDIX A

Military

MIL-C-5011	Charts: Standard Aircraft Characteristics and Performance, Piloted Aircraft (Fixed Wing)
MIL-D-8708	Demonstration Requirements for Airplanes
MIL-F-8785	Flying Qualities of Piloted Airplanes
MIL-A-8861	Airplane Strength and Rigidity Flight Loads
MIL-F-9490	Flight Control Systems - Design, Installation and Test of Piloted Aircraft, General Specification for
MIL-F-18372	Flight Control Systems: Design, Installation and Test of, Aircraft (General Specification for)
MIL-S-25015	Spinning Requirements for Airplanes
MIL-W-25140	Weight and Balance Control System (for Airplanes and Rotorcraft)
MIL-F-83300	Flying Qualities of Piloted V/STOL Aircraft
MIL-S-83691	Stall/post-stall/spin Flight Test Demonstration Requirements for Airplanes
AFGS-87221	Aircraft Structures, General Specification for
Navy BuAer SR-119B/USAF C-1815B	Flying Qualities of Piloted Airplanes

STANDARDS

Military

MIL-STD-756	Reliability Modeling and Prediction
MIL-STD-785	Reliability Program for Systems and Equipment Development and Production
MIL-STD-882	System Safety Program Requirements
MIL-STD-1629	Procedures for Performing a Failure Mode, Effects and Criticality Analysis

HANDBOOKS

Military

MIL-HDBK-217	Reliability Prediction of Electronic Equipment
MIL-HDBK-244	Guide to Aircraft/Stores Compatibility

REPORTS

Navy Rpt No. SA-C7R-75	First Interim Report, Flying Qualities Technical Evaluation of the F-14A Airplane; Humphrey, M. J.; November 1975 (declassified 31 December 1981)
Navy Rpt No. SA-14R-81	Navy Evaluation of the F/A-18A Airplane with Roll Rate Improvements Incorporated; Copeland, W., K. Grubbs, et al; March 1981
ASD-TDR-61-362	Fixed-Base and In-Flight Simulation of Longitudinal and Lateral-Directional Handling Qualities for Piloted Re-entry Vehicles; Kidd, E. A. and R. P. Harper; February 1964

MIL-STD-1797A
APPENDIX A

ASD-TDR-62-507	Handling Qualities in Single-Loop Roll Tracking Tasks: Theory and Simulator Experiments; Durand, T. S. and H. R. Jex; November 1962
ASD-TDR-63-399	Fixed-Base Simulator Investigation of the Effects of L_{α} , and True Speed on Pilot Opinion of Longitudinal Flying Qualities; Chalk, C. R.; November 1963
ASD-TR-72-48	Criteria for Predicting Spin Susceptibility of Fighter-Type Aircraft; Weissman, R.; June 1972
ASD-TR-78-13	USAF Flying Qualities Requirements for a STOL Transport; Gerken, G.; May 1979
WADC-TR-52-298	Artificial Stability Flight Tests of the XF-88A Airplane; Moore, N. B.; July 1954
WADC-TR-54-594	Flight Evaluations of Variable Short Period and Phugoid Characteristics in a B-26; Newell, F. d. and G. Campbell; December 1954
WADC-TR-55-299	Flight Evaluations of Various Longitudinal Handling Qualities in a Variable-Stability Jet Fighter; Harper, R. P., Jr.; July 1955
WADC-TR-56-258	Flight Evaluations in Variable-Stability Airplanes of Elevator Control Motion Gradients for High-Speed Bombers; Harper, R. P., Jr ; November 1956
WADC-TR-57-520	Human Pilot Dynamic Response; Seckel, E., 1. A. M. Hall, et al.; August 1958
WADC-TR-57-719 Part II	Additional Flight Evaluations for Various Longitudinal Handling Qualities in a Variable-Stability Jet Fighter, Chalk, C. R.; July 1958
WADC-TR-58-82	Approximate Airframe Transfer Functions and Application to Single Sensor Control Systems; Ashkenas, I. L. and D. T. McRuer; June 1958
WADC-TR-59-135	The Determination of Lateral Handling Quality Requirements from Airframe-Human Pilot System Studies; Ashkenas, I. L. and D. T. McRuer; June 1959
WADD-TR-61-147	In-Flight Simulation of the Lateral-Directional Handling Qualities of Entry Vehicles; Harper, R. P., Jr.; November 1961
AFFDL-TR-65-15	Human Pilot Dynamics in Compensatory Systems-Theory, Models, and Experiments with Controlled Element and Forcing Function Variations, McRuer, D., D. Graham, et al.; July 1965
AFFDL-TR-65-39	Ground Simulator Evaluations of Coupled Roll-Spiral Mode Effects on Aircraft Handling Qualities; Newell, F. D.; March 1965
AFFDL-TR-65-138	A Study of Conventional Airplane Handling Qualities Requirements. Part 1: Roll Handling Qualities; Ashkenas, I. L.; November 1965
AFFDL-TR-65-198	A Handling Qualities Theory for Precise Flight-Path Control; Bihrie, Jr.; June 1966

MIL-STD-1797A
APPENDIX A

AFFDL-TR-65-210 Simulated Landing Approaches of an Unaugmented C-5A Configuration; Newell, F. D., M. L. E. Parrag and G. Bull; December 1965

AFFDL-TR-65-218 Estimation of Flying Qualities of Piloted Airplanes; Woodcock, R. J. and D. E. Drake; April 1966

AFFDL-TR-65-227 Supersonic Transport Handling Characteristics During Approach and Landing Flight Regimes; Klein, R. H., R. B. Archer and D. W. Lew; December 1965

AFFDL-TR-66-2 Flight Evaluation of Various Phugoid and I/Th, Values for the Landing Approach Task; Chalk, C. R.; February 1966

AFFDL-TR-66-148 Flying Qualities Conference, Wright-Patterson Air Force Base, Ohio, 5 and 6 April, 1966; December 1966

AFFDL-TR-66-163 Flight Investigation of Longitudinal Short Period Frequency Requirements and PIO Tendencies; DiFranco, D. A.; June 1967

AFFDL-TR-67-2 Analysis of Several Handling Quality Topics Pertinent to Advanced Manned Aircraft; Stapleford, R. L. and J. A. Tennant; June 1967

AFFDL-TR-67-19 Pilot Evaluations in a Ground Simulator of the Effects of Elevator Control System Dynamics in Fighter Aircraft; Keith, L. A., R. R. Richard and G. J. Marrett; December 1968

AFFDL-TR-67-51 In-Flight Simulation and Pilot Evaluation of Selected Landing Approach Handling Qualities of a Large Logistics Transport Airplane; Rhoads, D W.; July 1967

AFFDL-TR-67-98 In-Flight Evaluation of Lateral-Directional Handling Qualities for the Fighter Mission; Mecker, J. I. and G. W. Hall; October 1967

AFFDL-TR-68-85 Investigation of the Effects of Gusts on V/STOL Craft in Transit)on and Hover; Skelton, G. B.; October 1968

AFFDL-TR-68-90 In-Flight Investigation of the Effects of Higher Order Control System Dynamics on Longitudinal Flying Qualities; DiFranco, D.; August 1968

AFFDL-TR-68-91 In-Flight Investigation of Longitudinal Short-Period Handling Characteristics of Wheel-Controlled Airplanes; Hall, G. W.; August 196,q

AFFDL-TR-69-3 In-Flight Investigation of the Effect on PIO of Control System Nonlinearities, Pitch Acceleration and Normal Acceleration Bobweights-, Newell, F. D. and R. Wasserman; May 1969

AFFDL-TR-69-41 A Flight Investigation of Lateral-Directional Handling Qualities for V/STOL Aircraft in Low Speed Maneuvering Flight; Doetsch, K. H. Jr., D. G. Gould and D. M. McGregor; March 1976

AFFDL-TR-69-67 A Non-Gaussian Turbulence Simulation; Reeves, P. M.; November 1969

AFFDL-TR-69-72 Background Information and User Guide for MIL-F-8785B(ASG), "Military Specification - Flying Qualities of Piloted Airplanes"; Chalk, C R., T. P. Neal, et al.; August 1969

MIL-STD-1797A
APPENDIX A

AFFDL-TR-70-74 An In-Flight Investigation to Develop Control System Design Criteria for Fighter Airplanes; Neal, T. P. and Rogers E. Smith, December 1970
Vols I and II

AFFDL-TR-70-145 An In-Flight Investigation of Lateral-Directional Dynamics for the Landing Approach; Hall, G. W. and E. M. Boothe; October 1971

AFFDL-TR-70-155 Validation of the Flying Qualities Requirements of MIL-F-00878SA(USAF); Brady, C. C. and J. Hodgkinson; January 1971

AFFDL-TR-71-134 Validation of the Flying Qualities Requirements of MIL-F-8785B(ASG), Kandalaft, R. N.; September 1971

AFFDL-TR-71-164 In-Flight Investigation of an Unaugmented Class III Airplane in the Landing Approach Task. Phase I: Lateral-Directional Study; Wasserman, R., F. F. Eckhart and H. J. Ledder; January 1972
Vol I

AFFDL-TR-72-36 Evaluation of Lateral-Directional Handling Qualities and Roll-Sideslip Coupling of Fighter Class Airplanes; Boothe, E. M. and M. L. Parrag, May 1972

AFFDL-TR-72-41 Revisions to MIL-F-8785B(ASG) Proposed by Cornell Aeronautical Laboratory Under Contract F33615-71-C-1254; Chalk, C. R., D A. DiFranco, et al.; April 1973

AFFDL-TR-72-141 Validation of the Flying Qualities Requirements of MIL-F-8785B(ASG) Using the P-3B Airplane; Richards, R. B., D. L. Green and J. C. Rennie, November 1973
Vol I

AFFDL-TR-72-143 In-Flight Simulation of Minimum Longitudinal Stability for Large Delta-Wing Transports in Landing Approach and Touchdown. Vol 1: Technical Results; Wasserman, R. and J. F. Mitchell; February 1973

AFFDL-TR-73-76 Recommended Revisions to Selected Portions of MIL-F-8785B(ASG) and Background Data; Ashkenas, I. L., R. H. Hoh and S. J. Craig; August 1973

AFFDL-TR-74-9 A Two-Phase Investigation of Longitudinal Flying Qualities for Fighters; Boothe, E. M., R. T. N. Chen and C. R. Chalk; April 1974

AFFDL-TR-74-61 Investigation of Flying Qualities of Military Aircraft at High Angles of Attack. Vol 1: Technical Results; Johnston, D. E., I. L. Ashkenas and J. R. Hogge; June 1974

AFFDL-TR-74-130 Extension of the Method for Predicting Six-Degree-of-Freedom Store Separation Trajectories at Speeds Up to the Critical Speed to Include A Fuselage with Noncircular Cross Section; Dillenius, M. F. E., F. K. Goodwin and J. N. Nielsen; November 1974
(2 Vols)

AFFDL-TR-75-3 Evaluation of the Flying Qualities Requirements of MIL-F-8785B(ASG) Using the C-5A Airplane-, Silvers, C. L. and C. C. Withers; March 1975

AFFDL-TR-76-78 Direct Side Force Control Criteria for Dive Bombing. Vol 1: Summary Vol II: Analysis and Results; Brulle, R. V., W. A. Moran and R. G Marsh; September 1976

MIL-STD-1797A
APPENDIX A

AFFDL-TR-77-57 A Theory for Longitudinal Short-Period Pilot Induced Oscillations; Smith, Ralph H.; June 1977

AFFDL-TR-78-9 Fighter CCV Phase IV Report, Vol II: Flight Test Data Evaluation. Vol III: Test Phase Data Summary, Parts I and 2; McAllister, J. D., et al.; February 1978

AFFDL-TR-78-122 Effects of Control System Dynamics on Fighter Approach and Landing Longitudinal Flying Qualities (Volume I); Smith, Rogers E.; March 1978

AFFDL-TR-78-171 Proceedings of AFFDL Flying Qualities Symposium Held at Wright State University 12-15 September, 1978; Black, G. T., Moorhouse, D. J., et al., compilers; December 1978:
"Task-Oriented Flying Qualities for Air-to-Ground Gun Attack;" Brandeau, G.
"B-1 Experience Related to MIL-F-8785B and Proposed Revisions;" Campbell, J. E.
"An Approach to Simplify the Specification of Low-Speed Maneuvering Pitch Control Force;" Cichy, D. R.
"High Angle of Attack Flying Qualities and Departure Criteria Development;" Hellman, G. K. and R. B. Crombie
"Northrop Review of MIL-F-8785B Proposed Revision;" Lockenour, J
"Evaluation of Selected Class III Requirements of MIL-F-8785B(ASG),
"Flying Qualities of Piloted Airplanes;" Withers, C. C.
"Discussion and Status of the Proposed Revision (1978) to MIL-F-8785B;" Moorhouse, D. J., R. J. Woodcock and T. P. Sweeney

AFFDL-TR-79-3126 Flight Qualities Design Requirements for Sidestick Controllers; Black, G. T. and D. J. Moorhouse; October 1979

AFWAL-TR-80-3032 Prediction of Supersonic Store Separation Characteristics Including Fuselage and Stores of Noncircular Cross Section (4 volumes); Goodwin, F. K., M. F. E. Dillenius and J. Mullen. Jr.; November 1980

AFWAL-TR-80-3060 Simulation Analysis: Unorthodox Control Force Fighter Aircraft, Vol II: Detailed Summary; Mitchell, A. L., et al.; April 1980

AFWAL-TR-80-3067 Flying Qualities Design Criteria: Proceedings of AFFDL Flying Qualities Symposium Held at Wright-Patterson Air Force Base in October 1979. Crombie, R. B. and D. J. Moorhouse, compilers; May 1980

AFWAL-TR-80-3141 Investigation of High-Angle-of-Attack Maneuvering - Limiting Factors, Part 1: Analysis and Simulation; Johnston, D. E., D. G. Mitchell and T T. Myers; December 1980

AFWAL-TR-81-3027 Development of Handling Quality Criteria for Aircraft with Independent Control of Six-Degrees-of-Freedom; Hoh, R. H., T. T. Myers, et al.; April 1981

MIL-STD-1797A
APPENDIX A

AFWAL-TR-81-3108 Investigation of High AOA Flying Qualities and Design Guides; Johnston, D. E. and R. K. Heffley; December 1981

AFWAL-TR-81-3109 Background Information and User Guide for MIL-F-8785C. Military Specification - Flying Qualities of Piloted Airplanes; Moorhouse, D J. and R. J. Woodcock; September 1981

AFWAL-TR-81-3116 Equivalent System Verification and Evaluation of Augmentation Effects on Fighter Approach and Landing Flying Qualities; Smith, Rogers E.; September 1981

AFWAL-TR-81-3118 In-Flight Investigation of Large Airplane Flying Qualities for Approach and Landing; Weingarten, N. C. and C. R. Chalk; September 1981

AFWAL-TR-81-3171 Lateral Flying Qualities of Highly Augmented Fighter Aircraft, Vols. I and 11; Monegan, S. J., Rogers E. Smith and R. E. Bailey; June 1982

AFWAL-TR-82-3014 Proposed Revisions to MIL-F-8785C Related to Flight Safety of Augmented Aircraft, 3 Vols.; Schuler, J. M. and M A. Dahl, April 1982

AFWAL-TR-82-3064 Design Criteria for the Future of Flight Controls, Proceedings of the Flight Dynamics Laboratory Flying Qualities and Flight Control Symposium, 2-5 March, 1982; Fuller, S. G. and Potts, D. W., compilers; July 1982

AFWAL-TR-82-3081 Proposed MIL Standard and Handbook - Flying Qualities of Air Vehicles, Vol II: Proposed MIL Handbook; Hoh, R. H., Mitchell, D. G., et al November 1982

AFWAL-TR-83-3015 Suggested Revisions to MIL-F-8785C for Large Class III Aircraft; Nleyer, R. T., et al.; February 1983

AFFDL-FGC-
TM-71-7 Validation of the Handling Qualities Degradation Probabilities of MIL-F-008785A Using F-4C Air Force Manual 66-1 Maintenance Data, Ullman, Lt., T. Calanducci, and Lt. Linck; August 1971

AFAMRL-TR-73-78 Manual Control Performance and Dynamic Response During Sinusoidal Vibration; Allen, R. Wade, Henry R. Jex, and Raymond E. Magdaleno, October 1973

AFAMRL-TR-81-39 Male and Female Strength Capabilities for Operating Aircraft Controls; McDaniel, Joe W.; March 1981

AFFTC-SD-69-5 A-7D Stability and Control Military Preliminary Evaluations (Phase IA and IB); Gobert, Don O. and William T. Twinting; April 1969

AFFTC-TD-75-1 Tracking Test Techniques for Handling Qualities Evaluation; Twisdale, T R. and D. L. Franklin; May 1975

AFFTC-TR-75-15 Flying Qualities Evaluation of the YF-16 Prototype Lightweight Fighter, Eggers, James A. and William F. Bryant, Jr.; July 1975

AFFTC-TR-75-32 F-15A Approach-to-Stall/Stall/Post-Stall Evaluation; Wilson, Donald B and Charles A. Winters; January 1976

AFFTC-TR-76-15 Flight Test Development and Evaluation of a Multimode Digital Flight Control System Implemented in an A-7D (DIGITAC), Damman,

MIL-STD-1797A
APPENDIX A

Lawrence, Robert Kennington, Paul Kirsten, Ronald Grabe, and Patrick Long; June 1976

AFFTC-TR-77-27 System Identification from Tracking (SIFT), a New Technique for Handling Qualities Test and Evaluation (Initial Report); Twisdale, T. R and T. A. Ashurst; November 1977

AFFTC-TR-79-2 Flying Qualities and Flight Control System Evaluation of the B-1 Strategic Bomber; Ross, Jerry L., Page G. McGirr, and Otto J. Waniczek, Jr.; May 1979

AFFTC-TR-79-10 F-16A/B Flying Qualities Full-Scale Development Test and Evaluation; Pape, James A. and Michael P. Garland; September 1979

AFFTC-TR-79-18 F-16A/B High Angle of Attack Evaluation; Wilson, Donald B. and Robert C. Ettinger; October 1979

AFFTC-TR-80-23 F-15C Flying Qualities Air Force Development Test and Evaluation; Shaner, Keith L. and Robert W. Barham; November 1980

AFFTC-TR-80-29 F-16 Flying Qualities with External Stores; Garland, Michael P., Michael K. Nelson, and Richard C. Patterson; February 1981

FDL-TDR-64-60 Flight Evaluation of Various Short Period Dynamics at Four Drag Configurations for the Landing Approach Task; Chalk, C. R., October 1964; Chalk, Charles R.; October 1964

FTC-TR-66-24 Frequency Response Method of Determining Aircraft Longitudinal Short Period Stability and Control System Characteristics in Flight; Klung, H A., Jr.; August 1966

FTC-TR-67-19 Evaluation of Longitudinal Control Feel System Modifications Proposed for USAF F/RF-4 Aircraft ; Keith, L. A., R. R. Richard, and G J. Marrett, December 1968

FTC-TD-72-1 Development and Evaluation of the TWeaD II Flight Control Augmentation System; Carleton, David L., Richard E. Lawyer, and Cecil W. Powell; November 1972

FrC-TD-73-2 Background Information and User Guide for MIL-S-83691; Sharp, Patrick S. and Collet E. McElroy, March 1974

FTC-TR-73-32 Air Force Evaluation of the Fly-by-Wire Portion of the Survivable Flight Control System Advanced Development Program; Majoros, Robert L.; August 1973

FTC-TIH-79-2 USAF Test Pilot School, Flying Qualities Handbook, Flying Qualities Theory and Flight Test Techniques; November 1979

USNTPS-FTM-103 Fixed Wing Stability and Control, Theory and Flight Techniques; 1 November 1981

FAA FAR Part 23 Airworthiness Standards: Normal, Utility, and Acrobatic Category Airplanes; June 1974

MIL-STD-1797A
APPENDIX A

FAA FAR Part 25	Airworthiness Standards: Transport Category Airplanes; June 1974
FAA-ADS-69-13	An In-Flight Investigation of Lateral-Directional Dynamics for Cruising Flight; Hall, G. W.; December 1969
FAA-RD-70-61	A Flight Simulator Study of STOL Transport Lateral Control Characteristics; Drake, Douglas E., Robert A. Berg, Gary L. Teper, and W. Allen Shirley; September 1970
FAA-RD-70-65	Flying Qualities of Small General Aviation Airplanes. Part 2: The Influence of Roll Control Sensitivity Roll Damping, Dutch-Roll Excitation, and Spiral Stability; Ellis, David R; April 1970
FAA-RD-74-206	Wind Models for Flight Simulator Certification of Landing and Approach Guidance and Control Systems; Barr, Neal M., Dagfinn Gangsaas, and Dwight R. Schaeffer; December 1974
FAA-RD-75-123	Identification of Minimum Acceptable Characteristics for Manual STOL Flight Path Control; Hoh, Roger H., Samuel J. Craig, and Irving L. Ashkenas; June 1976
FAA-RD-77-25	A Study of Lightplane Stall Avoidance and Suppression; Ellis, David R.; February 1977
FAA-RD-77-36	Wind Shear Modeling for Aircraft Hazard Definition; Frost, Walter and Dennis W. Camp; March 1977
FAA-RD-77-173	Proceedings of the First Annual Meteorological and Environmental Inputs to Aviation Systems Workshop. "Wind Models for Flight Simulator Certification of Landing and Approach Guidance and Control Systems", Schaeffer, Dwight R.; March 1977
FAA-RD-78-7	Simulation and Analysis of Wind Shear Hazard; Lehman, John M., Robert K. Heffley, and Warren F. Clement; December 1977
FAA-RD-79-59	Powered-Lift Aircraft Handling Qualities in the Presence of Naturally-Occurring and Computer-Generated Atmospheric Disturbances; Jewell, Wayne F., Warren F. Clement, Thomas C. West, and S. R. M. Sinclair; May 1979
FAA-RD-79-84	Piloted Flight Simulation Study of Low-Level Wind Shear, Phase 4; Foy, W. H. and W. B. Gartner; March 1979
FAA Advisory Circular AC25.253-1A	High-Speed Characteristics; 24 November 1965
DOT/FAA/CT-82/ 130-II	Flying Qualities of Relaxed Static Stability Aircraft, Vol II; McRuer, D. T and T. T. Myers; September 1982
NACA Memo Rpt L6E20	Flight Investigation to Improve the Dynamic Longitudinal Stability and Control-Feel Characteristics of the P-63A-1 Airplane with Closely Balanced Experimental Elevators, Johnson, Harold I.; July 1946
NASA Memo 1-29-59A	A Pilot Opinion Study of Lateral Control Requirements for Fighter- Type Aircraft; Creer, Brent Y., John D. Stewart, Robert B. Merrick, and Fred J. Drinkwater III; March 1959

MIL-STD-1797A
APPENDIX A

NASA Memo 12-10-58A	A Flight Investigation to Determine the Lateral Oscillatory Damping Acceptable for an Airplane in the Landing Approach; McNeill, Walter E. and Richard F. Vomaske; February 1959
NASA-CP-2028	Proceedings of the First Annual Meteorological and Environmental Inputs to Aviation Systems Workshop, "Wind Models for Flight Simulator Certification of Landing and Approach Guidance and Control Systems"; Schaeffer, Dwight R.; March 1977
NASA-CR-239	Development of Satisfactory Lateral-Directional Handling Qualities in the Landing Approach; Stapleford, Robert L., Donald E. Johnston, Gary L. Teper, and David H. Weir; July 1965
NASA-CR-635	In-Flight and Ground Based Simulation of Handling Qualities of Very Large Airplanes in Landing Approach; Condit, Philip M., Laddie G. Kimbrel, and Robert G. Root; October 1966
NASA-CR-778	Evaluation of Lateral-Directional Handling Qualities of Piloted Re-Entry-Vehicles Utilizing Fixed-Base and In-Flight Evaluations; Meeker, J I May 1967
NASA-CR-2017	Handling Qualities Criteria for the Space Shuttle Orbiter During the Terminal Phase of Flight; Stapleford, Robert L., Richard H. Klein, and Roger H. Hoh; April 1972
NASA-CR-2451	Non-Gaussian Atmospheric Turbulence Model for Use in Flight Simulators; Reeves, P. M., G. S. Campbell, V. M. Ganzer, and R. G. Joppa; September 1974
NASA-CR-2677	Manual and Automatic Flight Control During Severe Turbulence Penetration; Johnston, Donald E., Richard H. Klein, and Roger H. Hoh, April 1976
NASA-CR-152064	Investigation of the Vulnerability of Powered Lift STOLs to Wind Shear; Hoh, Roger H. and Wayne F. Jewell; October 1976
NASA-CR-152139	Study of a Safety Margin System for Powered-Lift STOL Aircraft; Heffley, Robert K. and Wayne F. Jewell; May 1978
NASA-CR-152194	A Study of Key Features of the RAE Atmospheric Turbulence Model; Jewell, Wayne F. and Robert K. Heffley; October 1978
NASA-CR-159059	An Investigation of Low-Speed Lateral Acceleration Characteristics of Supersonic Cruise Transports Using the Total In-Flight Simulator (TIFS), Weingarten, N. C.; July 1979
NASA-CR-159236	Calspan Recommendations for SCR Flying Qualities Design Criteria-, Chalk, C. R.; April 1980
NASA-CR-163108	Analyses of Shuttle Orbiter Approach and Landing Conditions; Teper, Gary L., Richard J. DiMarco, Irving L. Ashkenas, and Roger H. Hoh; July 1981
NASA-CR-172491	Pitch Rate Flight Control Systems in the Flared Landing Task and Design Criteria Development; Berthe, C. J., C. R. Chalk, and S. Sarrafian

MIL-STD-1797A
APPENDIX A

NASA-CR-177331	Mission-Oriented Requirements for Updating MIL-H-8501, Vols. I and II; Clement, W. F., et al.; January 1985
NASA-TM-86728	Application of Frequency Domain Handling Qualities Criteria to the Longitudinal Landing Task; Sarrafian, S. K. and B. G. Powers; August 1985
NASA-TM-X-62	Motion Simulator Study of Longitudinal Stability Requirements for Large Delta Wing Transport Airplanes During Approach and Landing with Stability Augmentation Systems Failed; Snyder, C. T., E. B. Fry, et al., December 1972
NASA-TM-X-1584	A Review of Transport Handling-Qualities Criteria in Terms of Preliminary, XB-70 Flight Experience; Powers, Bruce G.; May 1968
NASA-TN-D-173	Flight Investigation of Automatic Stabilization of an Airplane Having Static Longitudinal Instability; Russell, Walter R., S. A. Sjoberg, and William L Alford; December 1959
NASA-TN-D-211	Flight Investigation of Pilot's Ability to Control an Airplane Having Positive and Negative Static Longitudinal Stability Coupled with Various Effective Lift-Curve Slopes; Brissenden, Roy F., William L Alford, and Donald L. Mallick; February 1960
NASA-TN-D-746	Flight Controllability Limits and Related Human Transfer Functions as Determined from Simulator and Flight Tests, Taylor, Lawrence W. and Richard E. Day; May 1961
NASA-TN-D-779	Flight Investigation Using Variable-Stability Airplanes of Minimum Stability, Requirements for High-Speed, High-Altitude Vehicles; McFadden, Norman M., Richard F. Vomaske, and Donovan R Heinle; April 1961
NASA-TN-D-792	Attitude Control Requirements for Hovering Control Through the Use of a Piloted Flight Simulator; Faye, A. E., Jr.; April 1961
NASA-TN-D-1141	The Effect of Lateral-Directional Control Coupling on Pilot Control of an Airplane as Determined in Flight and in a Fixed-Base Flight Simulator; Vomaske, Richard F., Melvin Sadoff, and Fred J. Drinkwater III; November 1961
NASA-TN-D-1328	A Flight Determination of the Attitude Control Power and Damping Requirements for a Visual Hovering Task in the Variable Stability and Control X-14A Research Vehicle; Rolls, L. S. and F. J. Drinkwater; May 1962
NASA-TN-D-1552	A Study of a Pilot's Ability to Control During Simulated Augmentation System Failures; Sadoff, Melvin; November 1962
NASA-TN-D-1888	A Preliminary Study of Handling-Qualities Requirements of Supersonic Transports in High-Speed Cruising Flight Using Piloted Simulators; White, Maurice D., Richard F. Vomaske, Walter E. McNeill, and George E Cooper; May 1963
NASA-TN-D-2251	A Piloted Simulator Study of Longitudinal Handling Qualities of Supersonic Transport in the Landing Maneuver; Bray, Richard S., April 1964

MIL-STD-1797A
APPENDIX A

NASA-TN-D-3726 An Evaluation of the Handling Qualities of Seven General-Aviation Aircraft; Barber, Marvin R., Charles K. Jones, Thomas R. Sisk, and Fred W. Haise; November 1966

NASA-TN-D-3910 A Simulator and Flight Study of Yaw Coupling in Turning Maneuvers of Large Transport Aircraft; McNeill, W. E. and R. C. Innis; May 1967

NASA-TN-D-3971 Determination of Flight Characteristics of Supersonic Transports During the Landing Approach with a Large Jet Transport In-Flight Simulator; June 1967

NASA-TN-D-5153 The Use of Pilot Rating in the Evaluation of Aircraft Handling Qualities; Cooper, G. E. and Harper, R. P., Jr.; April 1969

NASA-TN-D-5466 Simulator Study of Coupled Roll-Spiral Mode Effects on Lateral-Directional Handling Qualities; Grantham, W. D., F. L. Moore, P. L. Deal, and J. M. Patton, Jr.; March 1970

NASA-TN-D-5957 Flight Investigation of the Roll Requirements for Transport Airplanes in Cruising Flight; Holleman, Euclid C.; September 1970

NASA-TN-D-6496 Analysis of a Coupled Roll-Spiral-Mode, Pilot-Induced Oscillation Experienced with the M2-F2 Lifting Body; Kempel, R. W.; September 1971

NASA-TN-D-6811 In-Flight Pilot Evaluations of the Flying Qualities of a Four-Engine Jet Transport; Holleman, Euclid C. and Glenn B. Gilyard; May 1972

NASA-TN-D-7703 Flight Investigation of Advanced Control Systems and Displays for a General Aviation Airplane; Loschke, Paul C., Marvin R. Barber, Einar K Enevoldson, and Thomas C. McMurtry; June 1974

NASA-TP-1368 Flight Comparison of the Transonic Agility of the F-111A Airplane and the F-111 Supercritical Wing Airplane; Friend, Edward L. and Glenn M. Sakamoto; December 1978

NASA-TR-R-199 Dynamic Response of Airplanes to Atmospheric Turbulence Including Flight Data on Input and Response; Houbolt, John C., Roy Steiner, and Kermit G. Pratt; June 1964

NADC-ED-6282 Proposal for a Revised Military Specification, 'Flying Qualities of Piloted Airplanes' (MIL-F-8785ASG) with Substantiating Text; Mazza, C. J., William Becker, et al.; 22 July 1963

NADC-76154-30 "Design Charts and Boundaries for Identifying Departure Resistant Fighter Configurations;" Bihrie, W., Jr. and Barnhart, B.; July 1978

NADC-77052-30 Development of VTOL Flying Qualities Criteria for Low Speed and Hover, Hoh, Roger H. and Irving L. Ashkenas; December 1979

NADC-78182-60 Development and Analysis of a CVA and a 1052 Class Fast Frigate Air Wake Model; Nave, Ronald L.; September 1978

NADC-81186-60 The Control Anticipation Parameter for Augmented Aircraft, Bischoff, D E.; May 1981

MIL-STD-1797A
APPENDIX A

NADC-85091-60 "Investigation of Departure Susceptibility Criteria Using the Dynamic Flight Simulator;" Rhodeside, G.; June 1985

20.4 Nongovernment documents

AIAA Paper 64-353 Jet Transport Operation in Turbulence; Soderlind, Paul A.; July 1964

AIAA Paper 69-898 Summary and Interpretation of Recent Longitudinal Flying Qualities Results; Ashkenas, I. L.; August 1969

AIAA Paper 75-985 In-Flight Simulation-of the Light Weight Fighters; Hall, G. W. and R. P. Harper; August 1975

AIAA Paper 77-1119 Direct-Force Flight-Path Control--the New Way to Fly; Watson, John H. and Jack D. McAllister; August 1977

AIAA Paper 77-1122 Equivalent System Approaches to Handling Qualities Analysis and Design Problems in Augmented Aircraft; Hodgkinson, J. and W. J. LaManna, 8-10 August 1977

AIAA Paper 77-1145 A Study of Key Features of Random Atmospheric Disturbance Models for the Approach Flight Phase; Heffley, Robert K.; August 1977

AIAA Paper 78-1500 Rolling Tail Design and Behavior as Affected by Actuator Hinge Moment, Ball, J. M.; August 1978

AIAA Paper 19-1781 Initial Results of an Inflight, Simulation of Augmented Dynamics in Fighter Approach and Landing; Hodgkinson, J. and K. A. Johnston; 6-8 August 1979

AIAA Paper 79-1962 Flight Tests of a Microprocessor Control System; Stengel, R F. and G. E. Miller; October 1979

AIAA Paper 80-0703 Review of Nonstationary Gust-Responses of Flight Vehicles, Gaonkar, G. H.; July 1980

AIAA Paper 80-1611-CP Flight Evaluation of Augmented Fighter Aircraft; Hodgkinson, J. and R. C. Snyder; 11-13 August 1980

AIAA Paper 80-1626-CP A Summary of an In-Flight Evaluation of Control System Pure Time Delays During Landing Using the F-8 DFBW Airplane; Berry, D. T., B G. Powers, K. J. Szalai, and R. J. Wilson; 11-13 August 1980

AIAA Paper 80-1627-CP Low Order Equivalent Models of Highly Augmented Aircraft Determined from Flight Data Using Maximum Likelihood Estimation; Shafer, M. F; 11-13 August 1980

AIAA Paper 80-1628-CP Handling Qualities Criteria for Wing-Level-Turn Maneuvering During an Air to Ground Delivery; Sammonds, R. I. and J. W. Bunnell, Jr., August 1980

AIAA Paper 80-1633 Identification of Flexible Aircraft from Flight Data; Eulrick, B. J. and E. D. Rynaski; August 1980

AIAA Paper 80-1836 The Turbulent Wind and Its Effect on Flight; Etkin, B.; August 1980

MIL-STD-1797A
APPENDIX A

AIAA Paper 81-0302	Atmospheric Disturbance Models and Requirements for the Flying Qualities Military Standard and Handbook; Heffley, R. K., W. F. Jewell, R. H. Hoh, and D. J. Moorhouse; January 1981
AIAA Paper 87-2561	Analysis and Application of Aircraft Departure Prediction Criteria to the AV-8B Harrier II; Tinger, H.L.; August 1987
SAE ARP 842B	Design Objectives for Flying Qualities of Civil Transport Aircraft
Delft Univ of Tech Memo M-304	Non-Gaussian Structure of the Simulated Turbulent Environment in Piloted Flight Simulation; van de Moeskijk, G. A. J.; April 1978
Princeton Univ Rpt 604	A Study of Pilot-Induced Lateral-Directional Instabilities; Caporali, R. L., J. P. Lamers, and J. R. Totten; May 1962
Princeton Univ Rpt 727	Lateral-Directional Flying Qualities for Power Approach; Seckel, E., G. E. Miller, and W. B. Nixon; September 1966
Princeton Univ Rpt 777	Comparative Flight Evaluation of Longitudinal Handling Qualities in Carrier Approach; Eney, J. A.; May 1966
Princeton Univ Rpt 797	Lateral-Directional Flying Qualities for Power Approach: Influence of Dutch Roll Frequency; Seckel, E., J. A. Franklin, and G. E. Miller, September 1967
Stanford Univ SUDAAR No. 489	Wind Modeling and Lateral Aircraft Control for Automatic Landing; Holley, William E. and Arthur E. Bryson; January 1975
ARC R&M No. 917	Preliminary Report on Behavior of Aeroplanes When Flying Inverted with Special Reference to Some Accidents on "A"; O'Gorman, Mervyn, Chairman, Accidents Committee; January 1919
ESDU Item No. 74031	Characteristics of Atmospheric Turbulence Near the Ground. Part II: Single Point Data for Strong Winds (Neutral Atmosphere), October 1974
ESDU Item No. 75001	Characteristics of Atmospheric Turbulence Near the Ground. Part III Variations in Space and Time for Strong Winds (Neutral Atmosphere), July 1975
IAS Paper 60-18	Development of Lateral-Directional Flying Qualities Criteria for Supersonic Vehicles, Based on a Stationary Flight Simulator Study; Crone, R. M. and R. C. A'Harrah; January 1960
ICAS-86-5.3.4	Handling Qualities for Unstable Combat Aircraft; Gibson, J. C.; September 1986
MDC Rpt A5596	Flying Qualities Analysis of an In-Flight Simulation of High Order Control System Effects on Fighter Aircraft Approach and Landing-, Johnston, K. A. and J. Hodgkinson, 22 December 1978
MDC Rpt A6792	Definition of Acceptable Levels of Mismatch for Equivalent Systems of Augmented Aircraft; Wood, J. R. and J. Hodgkinson; 19 December 1980
NLR-TR-79127U	Determination of Low-Speed Longitudinal Maneuvering Criteria for Transport Aircraft with Advanced Flight Control Systems; Mooij, H. A., W. P. Boer, and M. F. C. van Gool; 1979

MIL-STD-1797A
APPENDIX A

NLR Memorandum VS-77-024	A Digital Turbulence Model for the NLR Moving - Base Flight Simulator, Part I; Jansen, C. J., August 1977
NLR Memorandum VS-77-025	A Digital Turbulence Model for the NLR Moving - Base Flight Simulator, Part II; Jansen, C. J.; August 1977
Boeing D6-10725	A Simulator and Flight Evaluation of the Longitudinal and Lateral Control Requirements of the C-5A for the Landing Approach Task; Eldridge, W 18 May 1965
Boeing D6-10732 T/N	A Note on Longitudinal Control Response; Higgins, H. C.; June 1965
Calspan FRM No. 554	The Ideal Controlled Element for Real Airplanes Is Not K/s; Chalk, C. R.-, August 1981
Comell Aero Lab IH-2154-F-1	Flight Evaluation of a Stability Augmentation System for Light Airplanes; Eckhart, F. F., G. W. Hall, and P. A. Martino; November 1966
Cornell Aero Lab TB-574-F-3	A Flight Investigation of Minimum Acceptable Lateral Dynamic Stability, Graham, D. and C. James; 30 April 1950
Cornell Aero Lab TB-574-F-6	A Flight Investigation of Acceptable Roll to Yaw Ratio of the Dutch Roll and Acceptable Spiral Divergence; Bull, G.; February 1952
Cornell Aero Lab TB-1094-F-1	Flight Evaluations of the Effect of Variable Spiral Damping in a JTB-26B Airplane; Rhoads, D. W.; October 1957
Cornell Aero Lab TB-1444-F-1	Handling Qualities Requirements as Influenced by Prior Evaluation Time and Sample Size; Kidd, E. A. and G. Bull; February 1963
Douglas Aircraft Co. LB-25452	Investigation of Pilot-Induced Longitudinal Oscillation in the Douglas Model A4D-2 Airplane; Terrill, W. H., J. G. Wong, and L. R. Springer; 15 May 1959
General Dynamics Rpt FZM-12-2652	9 December 1968
Norair Rpt No. NOR-64-143	Pilot Induced Oscillations- Their Cause and Analysis; Ashkenas, Irving L., Henry R. Jex, and Duane T. McRuer; June 1964
Systems Tech. Inc. TR-124-1	A Systems Analysis of Longitudinal Piloted Control in Carrier Approach, Cromwell, C. J. and I. L. Ashkenas; June 1962
Systems Tech. Inc. TR-137-2	Carrier Landing Analyses; Durand, Tulvio; February 1967
Systems Tech. Inc. TR-189-1	Background Data and Recommended Revisions for MIL-F-8785B(ASG), 'Military Specification -- Flying Qualities of Piloted Airplanes'; Craig, Samuel J. and Irving L. Ashkenas; March 1971
Systems Tech. Inc. TR-190-1	Outsmarting MIL-F-8785B(ASG), the Military Flying Qualities Specification; Stapleford, Robert L., Duane T. McRuer, Roger H. Hoh, et al.; August 1971
Systems Tech. Inc. TR-199-1	Analytical Assessment of the F-14 Aircraft Control and Handling Characteristics; Johnston, Donald E. and Samuel J. Craig; February 1972

MIL-STD-1797A
APPENDIX A

Systems Tech. Inc. TR-1090-1	Analytical Assessment of the F-18A Flying Qualities During Carrier Approach; Ringland, R. F. and D. E. Johnston; September 1977
Systems Tech. Inc. WP-189-3	Effect of Sideslip on Precise Lateral Tracking; Hoh, R. H. and H. R. Jex; November 1969
Vought Corp Rpt No. 2-55800/8R-3500	Mathematical Models for the Aircraft Operational Environment of DD-963 Class Ships; Fortenbaugh, R. L.; September 1978
AGARD Rpt 122	The Influence of Drag Characteristics on the Choice of Landing Approach Speeds; Lean, D. and R. Eaton; 1957
AGARD Rpt 357	Some Low-Speed Problems of High-Speed Aircraft; Spence, A. and D. Lean, 1961
AGARD Rpt 372	Theory of the Flight of Airplanes in Isotropic Turbulence - Review and Extension; Etkin, B.; April 1961
AGARD Rpt 420	Flight Measurements of the Influence of Speed Stability on the Landing Approach; Staples, K. J.; 1963
AGARD-AR-82	The Effects of Buffeting and Other Transonic Phenomena on Maneuvering Combat Aircraft; Hamilton, B. 1. L.; July 1975
AGARD-AR- 134	Technical Evaluation Report on the Flight Mechanics Panel Symposium on Stability and Control; Chalk, C. R.; January 1979
AGARD-CP-17	AGARD Stability and Control Meeting, September 1966 "Flying Qualities Criteria Problems and Some Proposed Solutions," Carlson, John W. and Richard K. Wilson "Pilot-Induced Instability;" A'Harrah, R. C. and R. F. Siewert
AGARD-CP- 1 19	Stability and Control; "Flight Simulation - A significant Aid In Aircraft Design;" A'Harrah, R. C.; April 1972
AGARD-CP-199	Stall/Spin Problems in Military Aircraft; June 1976
AGARD-CP-235	Dynamic Stability Parameters; 'Aircraft Stability Characteristics at High Angle of Attack;" Kalviste, J.; November 1978
AGARD-CP-249	Piloted Aircraft Environment Simulation Techniques, "Handling Qualities of a Simulated STOL Aircraft in Natural and Computer-Generated Turbulence and Shear;" Sinclair, S. R. M. and T. C. West; October 1978

MIL-STD-1797A
APPENDIX A

AGARD-CP-260 Proceedings of AGARD Flight Mechanics Panel Symposium on Stability and Control, September 1978
"Are Today's Specifications Appropriate for Tomorrow's Airplanes?" A'Harrah, R. C., J. Hodgkinson, and W. J. LaManna
"Flying Qualities and the Fly-by-Wire Aeroplane;" Gibson, J. C.
"L-1011 Active Controls Design Philosophy and Experience;" Urie, David M.

AGARD-CP-319 Combat Aircraft Maneuverability-, "The Military Flying Qualities Specification, a Help or a Hindrance to Good Fighter Design?" A'Harrah, Ralph C. and Robert J. Woodcock; December 1981

AGARD-CP-333 Criteria for Handling Qualities in Military Aircraft; "Simulation for Predicting Flying Qualities;" Reynolds, P. A.; June 1982

NATO Rpt 408A Recommendations for V/STOL Handling Qualities; October 1964

NRC of Canada Rpt LTR-FR- 12 A Flight Investigation of Lateral-Directional Handling Qualities of V/STOL Aircraft in Low Speed Maneuvering Flight; Doetsch, K. H., et al ; 15 August 1969

RAE Aero. 2504 Problems of Longitudinal Stability Below Minimum Drag, Speed, and Theory of Stability Under Constraint; Neumark, S.; 1953

RAE Aero. 2688 A Review of Recent Handling Qualities Research, and Its Application to the Handling Problems of Large Aircraft. Part I: Observations on Handling Problems and Their Study. Part II: Lateral-Directional Handling; Bisgood, P. L.; June 1964

RAE TM-FS-46 Developments in the Simulation of Atmospheric Turbulence; Tomlinson, B. N.; September 1975

RAE TR-68140 Control Characteristics of Aircraft Employing Direct Lift Control, Pinsker, W. J. G.; May 1968

RAE TR-71021 Glide Path Stability of an Aircraft Under Speed Constraint, Pinsker, W. J. G.; February 1971

TSS Standard 5 Supersonic Transport Aeroplane Flying Qualities; 22 May 1964

Ad Hoc Committee Report on B-58 Controllability in Flight, Wright Air Development Division, Wright-Patterson AFB, OH, 2 April - 10 May, 1960

Anderson, Ronald O., A Second Analysis of B-58 Flight Control System Reliability, Flight Control Laboratory, Wright-Patterson AFB, OH, 6 November 1962

Ashkenas, I. L. and T. Durand, "Simulator and Analytical Studies of Fundamental Longitudinal Control Problems in Carrier Approach," presented at AIAA Simulation for Aerospace Flight Conference, August. 1963

Behel, I. M. and W. B. McNamara, "F/A-18A High Angle of Attack/Spin Testing," 25th International Report to the Aerospace Profession, Society of Experimental Test Pilots, September, 1981

MIL-STD-1797A
APPENDIX A

Bureau of Naval Weapons Failure Rate Data Handbook, prepared by U. S. Naval Ordnance Laboratory; Corona, CA (updated periodically)

Caravello, Christopher, Randal G. Joslin, Giuseppe Fristachi, Charles R. Bisbee, Steven S. Weatherspoon, and Steven G. Henrich, Limited Flight Evaluation as a Function of Aircraft Longitudinal Dynamics, Air Force Test Pilot School, Class 79A Final Report, December, 1979

Curry, R. E. and A. G. Sim, Unique Flight Characteristics of the AD-1 Oblique-Wing Research Airplane, J Aircraft, v. 20, nr. 6, June, 1983

"Development of the F/A-18 Handling Qualities Using Digital Flight Control Technology," Society of Experimental Test Pilots 1982 Report to the Aerospace Profession, 26th Annual Proceedings, September, 1982

Dryden, Hugh L., "A Review of the Statistical Theory of Turbulence," Turbulence - Classic Papers on Statistical Theory, New York: Interscience Publishers, Inc., 1961

Etkin, B., "A Theory of the Response of Airplanes to Random Atmospheric Turbulence," J. Aero/Space Sciences, July, 1959, 409-420

Etkin, Bernard, Dynamics of Atmospheric Flight, New York: Wiley, 1972

Etkin, Bernard, Dynamics of Flight, New York: Wiley, 1959

Finberg, Floyd, Report of the T-38 Flight Control System PIO Review Board. USAF ASD, February, 1963

Hirsch, Darrell, "Investigation and Elimination of PIO Tendencies in the Northrop T-38A," SAE Paper, New York, July, 1964

Hodgkinson, J., "Equivalent Systems Approach for Flying Qualities Specification," presented at SAE Aerospace Control and Guidance Systems Committee Meeting, Denver, CO, 7-9 March, 1979

Hodgkinson, J., R. L. Berger, and R. L. Bear, "Analysis of High Order Aircraft/Flight Control System Dynamics Using an Equivalent System Approach," presented at 7th Annual Pittsburgh Conference on Modeling and Simulation, 26-27 April, 1976

Hodgkinson, J., W. J. LaManna, and J. L. Heyde, "Handling Qualities of Aircraft with Stability and Control Augmentation Systems - A Fundamental Approach," J. R. Ae. S., February, 1976

Houbolt, John C., "Atmospheric Turbulence," AIAA J., Vol. II, No. 4, April, 1973, 421-437

"Industry Observer," Aviation Week and Space Technology, 1 April, 1968, 13

Jacobson, Ira D. and Dinesh S. Joshi, "Investigation of the Influence of Simulated Turbulence on Handling Qualities," J. Aircraft, Vol. 14, No. 3, March 1977, 272-275

Jones, J. G., "Modeling of Gusts and Wind Shear for Aircraft Assessment and Certification," Royal Aircraft Establishment, Paper prepared for CAARC Symposium on Operational Problems, India, October, 1976

Lappe, V. Oscar and Ben Davidson, "On the Range of Validity of Taylor's Hypothesis and the Kilmogoroff Spectral Law," J. Atmos. Sciences, Vol. 20, November, 1963

Lappe, V. Oscar, "Low-Altitude Turbulence Model for Estimating Gust Loads on Aircraft," J. Aircraft, Vol. 3, No. 1, Jan - Feb, 1966

MIL-STD-1797A
APPENDIX A

- Lumley, John L. and Hans A. Panofsky, The Structure of Atmospheric Turbulence, New York: Interscience Publishers, Inc., 1964
- McRuer, Duane, Irving Ashkenas, and Dunstan Graham, Aircraft Dynamics and Automatic Control, Princeton University Press, 1973
- Mitchell, David G. and Roger H. Hoh, "Low-Order Approaches to High-Order Systems: Problems and Promises," J. Guidance, Control, and Dynamics, Vol. 5, No. 5, Sept - Oct 1982, 482-489
- Morgan, Clifford T., Jesse S. Cook, Alphonse Chapanis, and Max W. Lund, eds., Human Engineering Guide to Equipment Design, New York: McGraw-Hill, 1963
- Morgan, Len, "Out for a Spin," Flying, February, 1982
- Neal, T. Peter, "Influence of Bobweights on Pilot-Induced Oscillations," J. Aircraft, September, 1971
- Otnes, R. K. and L. Enochson; Applied Time Series Analysis, Vol. 1. Basic Techniques; New York- Wiley-Interscience; 1978
- Perkins, Courtland D. and Robert E. Hage, Airplane Performance Stability and Control, New York- Wiley 1949
- "Proposals for Revising Mil-F-8785B, 'Flying Qualities of Piloted Airplanes'," AFFDI,-FGC Working, Paper, February, 1978
- Rediess, H. A., D. L. Mallick, and D. T. Berry, Recent Flight Test Results on Minimum Longitudinal Handling Qualities for Transport Aircraft, presented at the FAUST VIII Meeting, Washington, D.C., January 1981
- Richards, D. and C. D. Pilcher, "F/A-18A Initial Sea Trials," SETP Cockpit, April/May/June, 1980
- Sammonds, R. I., W. E. McNeill, and J. W. Bunnell, "Criteria for Side-Force Control in Air-to-Ground Target Acquisition and Tracking," J. Aircraft, v. 19, nr. 9, September, 1982
- Scott, W. B., "Reengined KC-135 Shows Performance Gains in Test," Aviation Week & Space Technology, v. 118, nr. 8, McGraw-Hill, February 21, 1983
- Stengel, R. F. and G. E. Miller, "Pilot Opinions of Sampling Effects in Lateral-Directional Control," presented at 16th Annual Conference on Manual Control, Cambridge, MA, May, 1980
- Tentative Airworthiness Objectives and Standards for Supersonic Transport Design Proposals, Flight Standards Service, FAA, 15 August, 1963
- Van Patten, Robert E., Investigation of the Effects of g_y and g_z on AFTI/F-16 Control Inputs. Restraints and Tracking Performance, Interim USAF AMRL Technical Report, August, 1981
- von Karman, Theodore, "Progress in the Statistical Theory of Turbulence," Turbulence - Classic Papers on Statistical Theory, New York: Interscience Publishers, Inc., 1961

30. DEFINITIONS

3.1 Aircraft classification and operational missions.

For the purpose of this standard, the aircraft specified in this requirement is to accomplish the following missions: _____. The aircraft thus specified will be a Class ____ aircraft. The letter -L following a class designation identifies an aircraft as land-based; carrier-based aircraft are similarly identified by -C. When no such differentiation is made in a requirement, the requirement applies to both land-based and carrier-based aircraft.

REQUIREMENT RATIONALE (3.1)

The very reason for procuring aircraft is to perform one or more missions. The class designation is used in the handbook to help particularize the requirements according to broad categories of intended use.

REQUIREMENT GUIDANCE

The related MIL-F-8785C paragraphs are 1.3, 1.3.1 and 3.1.1.

Missions

The standard needs a specific mission statement to furnish guidance for interpreting qualitative requirements as well as for consistent selection of quantitative requirements. Unfortunately, the word "mission" is used in several contexts not only in this standard, but throughout the writings pertinent to acquiring a new weapon system. In the broadest sense, "operational missions" applies to classifying the aircraft as fighter, bomber, reconnaissance, etc., or to "accomplishing the mission" of bombing, strafing, etc. In 3.1 the object is to introduce to the designer in general terms the function of the vehicle he is to design. It should be sufficient for the procuring activity to refer to those paragraphs of the System Specification and Air Vehicle Specification to define the overall performance requirements, the operational requirements, employment and deployment requirements.

The operational missions considered should not be based on just the design mission profiles. However, such profiles serve as a starting point for determining variations that might normally be expected in service, encompassing ranges of useful load, flight time, combat speed and altitude, in-flight refueling, etc., to define the entire spectrum of intended operational use. "Operational missions" include training and ferry missions.

The intended use of an aircraft must be known before the required configurations, loadings, and the Operational Flight Envelopes can be defined and the design of the aircraft to meet the requirements of this standard undertaken. If additional missions are foreseen at the time the detail specification is prepared, it is the responsibility of the procuring activity to define the operational requirements to include these missions. Examples of missions or capabilities that have been added later are in-flight refueling (tanker or receiver), aerial pickup and delivery, low-altitude penetration and weapon delivery, and ground attack for an air-superiority fighter or vice versa.

Once the intended uses or operational missions are defined, a Flight Phase analysis of each mission must be conducted. With the Flight Phases established, the configurations and loading states which will exist during each Phase can be defined. After the configuration and loading states have been defined for a given Flight Phase, Service and Permissible Flight Envelopes can be determined and Operational Flight Envelopes more fully defined.

MIL-STD-1797A
APPENDIX A

For military rotorcraft STI has proposed (NASA CR 177331 or NASA CR 177304) a more detailed alternative to general category, class and flight phase definitions. Each Flight Phase is assigned specific appropriate tasks, 3 to 14 in number. Each of these tasks is quantified in terms of a detailed maneuver, including tolerances on performance. This structure should provide an adequate basis for evaluating mission-task performance and pilot workload, which are the essence of flying qualities, directly rather than through the response parameters by which flying qualities are usually specified. Although more difficult to relate back to design, this alternative provides an excellent set of criteria for assessing operational worth of the actual vehicle in flight.

Classification of Aircraft--An aircraft is placed in one of the following Classes:

- Class I: Small light aircraft such as:
 - Light utility
 - Primary trainer
 - Light observation
- Class II: Medium weight, low-to-medium maneuverability aircraft such as:
 - Heavy utility/search and rescue
 - Light or medium transport/cargo/tanker
 - Early warning/electronic countermeasures/airborne command, control, or communications relay
 - Antisubmarine
 - Assault transport
 - Reconnaissance
 - Tactical bomber
 - Heavy attack
 - Trainer for Class II
- Class III: Large, heavy, low-to-medium maneuverability aircraft such as:
 - Heavy transport/cargo/tanker
 - Heavy bomber
 - Patrol/early warning/electronic countermeasures/airborne command, control, or communications relay
 - Trainer for Class III
- Class IV: High-maneuverability aircraft such as:
 - Fighter-interceptor
 - Attack

MIL-STD-1797A
APPENDIX A

Tactical reconnaissance

Observation

Trainer for Class IV

The Class designation aids in selecting and interpreting handbook material. The procuring activity will assign an aircraft to one of these Classes, and the handbook requirements for that Class are meant to apply. When no Class is specified in the requirement, the requirement is meant to apply to all Classes. When operational missions so dictate, an aircraft of one Class should be required by the procuring activity to meet selected requirements ordinarily specified for aircraft of another Class. The classification scheme simplifies mission definition. Basically, the four Classes are related qualitatively to maximum design gross weight and symmetrical flight limit load factor at the basic flight design gross weight, as shown on figure 3.

The presentation of figure 3 makes it obvious that highly maneuverable aircraft such as fighter and attack types, together with certain trainer and observation craft, should be designed for high limit load factor. These vehicles tend to group in the weight range from 5000 to 100,000 lb. There are a few small, lightweight trainers and observation aircraft which are also designed for fairly high load factors, which could be in either Class I or Class IV. Classification of these aircraft should be on the basis of more detailed information about the intended use; or alternatively the detail specification should be a combination of appropriate requirements.

Figure 3 also illustrates that all other aircraft are required to be designed for a limit load factor of less than 4 g, and that current aircraft span the weight range from 1000 to almost 1,000,000 lb. In addition, there may be significant differences in the way each vehicle responds to atmospheric turbulence or wind shear. Another factor of possible significance is the location of the pilot in the vehicle relative to the center of gravity and the extremities of the vehicle. The location of the pilot in the vehicle affects his motions and ride qualities. If the effects of each of these factors on handling or flying qualities were fully understood and a sufficient data base existed, then the quantitative requirements could be stated as mathematical or empirical functions of the significant factors, and there would be no need for any classification breakdown to accommodate these effects in the specification requirements.

It should also be recognized that as vehicles become larger, practical design considerations may dictate compromises between the degree of maneuverability and the values of flying qualities parameters that are desirable and what can be accepted, through relaxation of operational requirements or through modification of operational procedures or techniques.

How best to handle the factors discussed above is not completely clear at this time. Ideally the requirements should be expressed as mathematical functions of the significant factors. The current state of knowledge and the experimental data available do not permit this, so it is necessary to make the relatively arbitrary Class definition. Further research into possible scaling parameters, simulation study, and operational experience is required in this area.

REQUIREMENT LESSONS LEARNED

In keeping with overall guidance to relate requirements to the intended mission, this mission statement has been found to be necessary to guide selection of flight conditions and tailoring of requirements.

MIL-STD-1797A
APPENDIX A

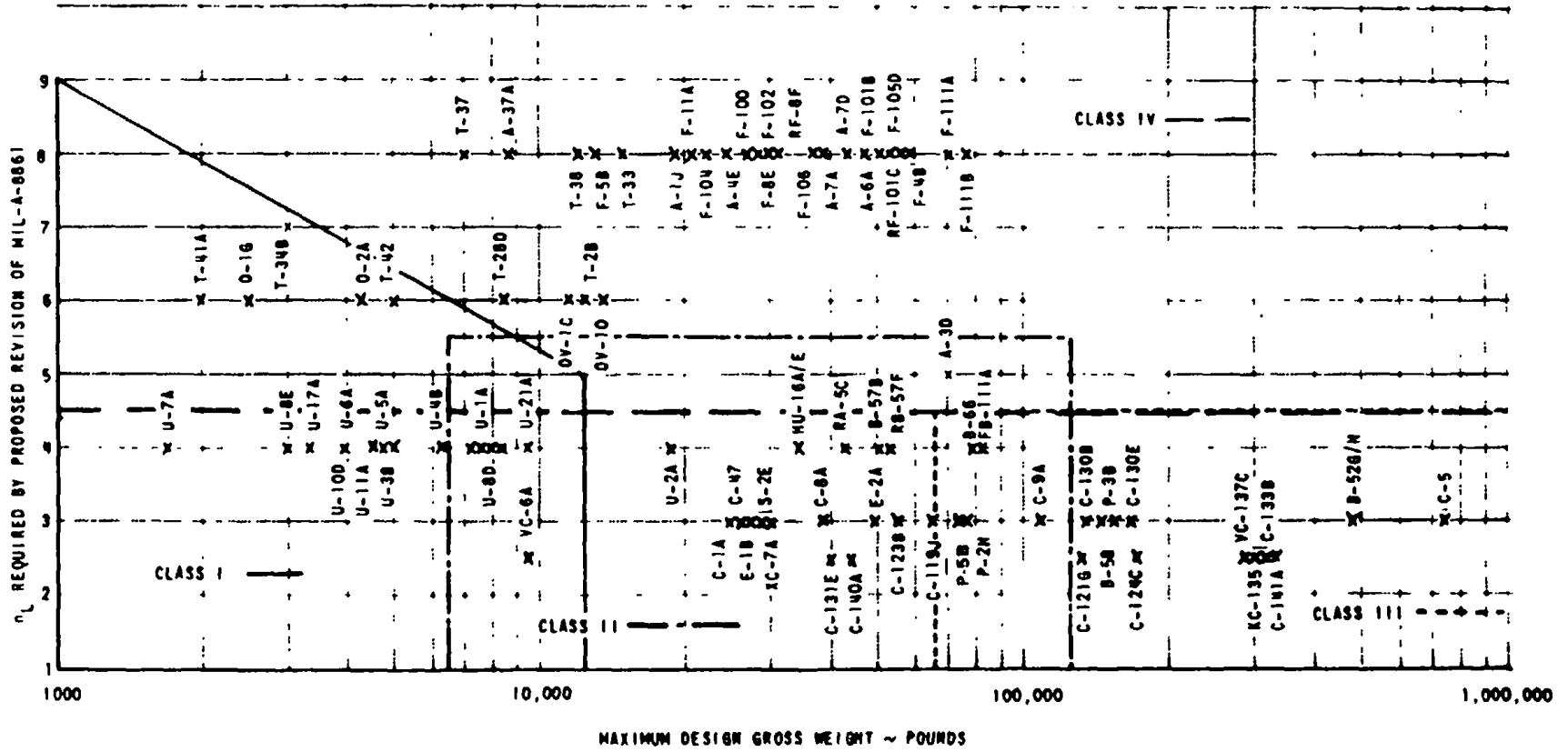

FIGURE 3. Classification of aircraft (AFFDL-TR-69-72).

MIL-STD-1797A
APPENDIX A

3.2 Flight Phase Categories.

To accomplish the mission requirements the following general Flight Phase Categories are involved: _____ . Special Flight Phases to be considered are: _____ .

REQUIREMENT RATIONALE (3.2)

Flying qualities requirements vary for the different phases of a mission. To the extent permitted by available data, these variations have been taken into account.

REQUIREMENT GUIDANCE

The related MIL-F-8785C paragraph is 1.4.

The appropriate Flight Phases to be listed are to be chosen from the material that follows. Experience with aircraft operations indicates that certain Flight Phases require more stringent values of flying qualities parameters than do others (e.g., air-to-air combat requires more dutch roll damping than does cruising flight). Also, a given mission Flight Phase will generally have an Aircraft Normal State associated with it (e.g., flaps and gear down for landing approach and up for cruising flight; maximum gross weight).

In flight and simulator evaluations, pilots generally rate a set of flying qualities on suitability for a given mission segment like one of these Flight Phases. The pilots assign an overall rating, based on ability and effort required to perform certain appropriate tasks such as precision tracking of a target or a glide slope, trimming and making heading changes at constant altitude, in an appropriate environment. The similarity, of tasks in many Flight Phases, plus the limited amount of evaluation data on specific Flight Phases, has led to grouping the Phases into three Categories.

Nonterminal Flight Phases:

Category A.

These nonterminal Flight Phases that require maneuvering, precision tracking, or precise flight-path control. Included in this Category are:

- a. Air-to-air combat (CO)
- b. Ground attack (GA)
- c. Weapon delivery/launch (WD)
- d. Aerial recovery (AR)
- e. Reconnaissance (RC)
- f. In-flight refueling (receiver) (RR)
- g. Terrain following (RF)
- h. Antisubmarine search (AS)
- i. Close formation flying (FF)
- j. Low-altitude parachute extraction (LAPES) delivery

Category B:

Those nonterminal Flight Phases that are normally accomplished using gradual maneuvers and without precision tracking, although accurate flight-path control may be required. Included in this Category are:

- a. Climb (CL)

MIL-STD-1797A
APPENDIX A

- b. Cruise (CR)
- c. Loiter (LO)
- d. In-flight refueling (tanker) RT)
- e. Descent (D)
- f. Emergency descent (ED)
- g. Emergency deceleration (DE)
- h. Aerial delivery (AD)

Terminal Flight Phases:

Category C:

Terminal Flight Phases are normally accomplished using gradual maneuvers and usually require accurate flight-path control. Included in this Category are:

- a. Takeoff (TO)
- b. Catapult takeoff (CT)
- c. Approach (PA)
- d. Waveoff/go-around (WO)
- e. Landing (L)

When necessary, the procuring activity may specify recategorization or addition of Flight Phases or delineation of requirements for special situations, e.g., zoom climbs.

These Flight Phases are to be considered in the context of the total mission so that there will be no gap between successive Phases of any flight, and so that transition will be smooth. In certain cases, requirements are directed at specific Flight Phases identified in the requirement. When no Flight Phase or Category is stated in a requirement, that requirement is meant to apply to all three Categories.

For the most part, the Flight Phase titles are descriptive enough to facilitate picking those applicable to a given design. The Formation Flying (FF) Flight Phase is intended to be used, if desired, where there is no other requirement for rapid maneuvering, precision tracking, or precise flight-path control in up-and-away flight. An example might be a Class I trainer for which the procuring activity desires Category A flying qualities (note the use of the T-37, T-38, etc. in non-training roles).

Not all of these Flight Phases apply to a given aircraft. Those that are appropriate to design operational missions and emergencies will be chosen for each design. The list cannot be exhaustive because new mission requirements continue to be generated. Thus the procuring activity may delete some Phases and add others. Responsibility for choosing applicable Flight Phases, as with filling in most or all of the blanks, is initially the procuring activity's. The contractor should assure that this listing is inclusive and exhaustive (for the stated primary and alternate missions), and suggest necessary additions. It is the procuring activity's responsibility either to agree with the contractor's suggestions or to recategorize the Flight Phases.

In certain cases, both flying qualities requirements and aircraft capabilities may be less than one would ordinarily expect. An example is a zoom climb—a dynamic maneuver in which qualities such as speed stability and natural frequency cannot be measured in flight, and the effectiveness of aerodynamic controls

MIL-STD-1797A
APPENDIX A

is necessarily low at low dynamic pressure. Lacking enough data to formulate general quantitative requirements for these cases, we leave for the procuring activity the provision of specific requirements as specific mission needs dictate.

For each Flight Phase or Flight Phase Category (depending upon the data available) typical flight conditions, maneuvers, disturbances, side tasks, etc. have been assumed in setting the suggested numerical values. The accurate flight-path control for landing, as an example, may well be a high-pin piloting task to which some Category A requirements apply. In tailoring the requirements for a particular procurement, any envisioned operating conditions more lax or more stringent than normal should be taken into account to the extent possible.

REQUIREMENT LESSONS LEARNED

As an example of the last caveat above, consider the A-10 experience documented by Brandeau in AFFDL-TR-78-171. That airplane appeared to meet MIL-F-8785B Level 1 requirements for Category A (which includes ground attack) and it was rated Level 1 during flight tests using a straight-in approach. Its flying qualities were unsatisfactory, however, when evaluated in an operationally realistic ground attack task.

In close air support, a wide variety of attack maneuvers may be characterized by three general phases, as shown in figure 4:

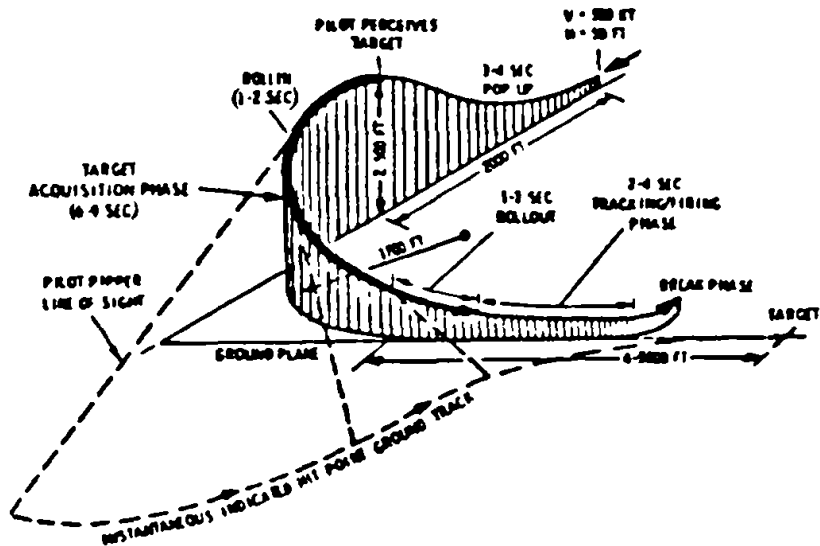

FIGURE 4. Ground attack maneuver scenario.

Target acquisition - Rapid rolling toward target while developing 4 to 5 g's; bank and g's held until rollout onto target (return to zero bank and 1 g)

Weapon delivery or tracking/firing - errors eliminated and piper maintained on target

Break - a gross maneuver to reposition for another attack while looking after aircraft survival.

For gross target acquisition maneuvers, highly predictable terminal orientation of the velocity vector is vital in order to minimize the duration of the relatively vulnerable weapon delivery phase. Excellent roll response is required, in terms of both quickness and maintaining turn coordination. Weapon delivery requires rapid, precise control of the velocity vector for dropping unguided bombs, or of the piper line of sight (and thus aircraft attitude) for gunnery.

MIL-STD-1797A
APPENDIX A

While the original A-10 stability augmentation apparently met MIL-F-8785B requirements on lateral-directional dynamics, and pilots rated it satisfactory in "the originally planned tactical maneuvers... It was only as the maneuvers became very aggressive that the problem surfaced." For these aggressive maneuvers, the average maxima quoted are:

normal acceleration	4.5 g
roll rate	93 deg/sec
bank angle	93 deg
tracking time	2.33 sec

To satisfy the requirements of the task outlined above, the aerodynamic configuration remained unchanged and the flight control system modifications were relatively minor. This will not necessarily be so in more sophisticated designs. The cost of fixing such deficiencies could be very high after a new aircraft has flown, and so it would obviously be beneficial to consider operational maneuvers as early as possible in the design phase. In the example cited, little more than figure 4 would be required as an additional Flight Phase in the specification.

For this more severe Flight Phase, more stringent requirements might be placed on Dutch roll damping and roll-yaw coupling--see figure 5 responses of lateral tracking error to a roll control doublet. Although the A-10 deficiency was indicated at high g's, certainly for such a severe Flight Phase the lateral-directional characteristics must be investigated in pullups and turns - and roll-sideslip coupling in rapid rolls-as well as in straight flight. (While the requirements of MIL-F-8785B apply throughout the V-h-n Flight Envelopes, often the lateral-directional behavior has been evaluated primarily in 1-g flight.) Commonly it is observed that the amount of aileron-to rudder crossfeed needed to coordinate turn entries varies considerably with angle of attack. Thus, one might find no single crossfeed gain suitable for all phases of the ground attack described.

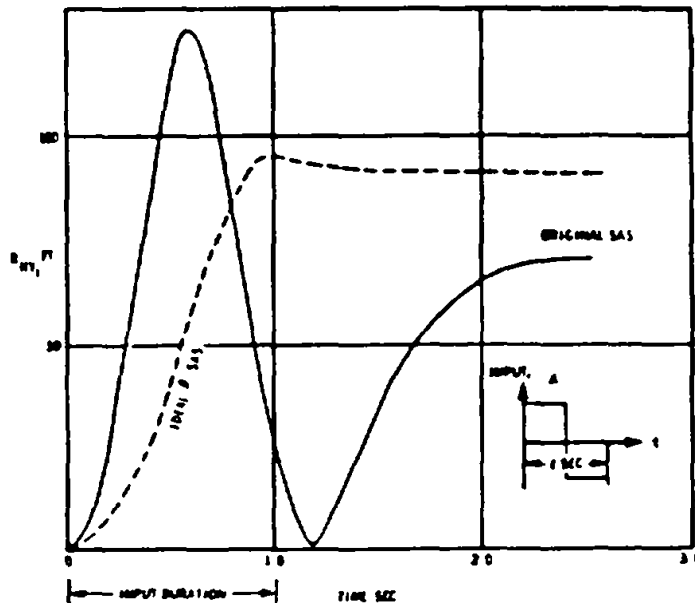

FIGURE 5. Response to a 1-second, half-stick aileron doublet for tracking scenario.

MIL-STD-1797A
APPENDIX A

In addition, advancing flight control technology has greatly increased the potential for tailoring the flying qualities for specific tasks within a Flight Phase Category without compromising other tasks. Truly task-oriented flying qualities would receive an impetus from the inclusion of requirements related to actual operational tasks into the specification for a particular aircraft.

An example of the need for better flight characteristics for an added task is the low-altitude parachute extraction mission, in which the pilot must fly precisely at very low altitude. According to an Air Force test pilot, for this task the C-130 is "Level 2 at best, mostly Level 3". The lesson again is to account for the flying qualities implications of changes in operational usage.

To the extent feasible, we have tailored the requirements to particular tasks of the Flight Phases. A very important, but unstated, corollary is the need to avoid inconsistencies in flight control mechanization from one Flight Phase or configuration to another. Drastic or numerous changes in control mode have the potential to confuse the pilot, to the detriment of mission effectiveness or even flight safety. With few exceptions, a single flight technique should suit all operations.

MIL-STD-1797A
APPENDIX A

3.3 Levels and qualitative suitability of flying qualities.

The handling characteristics described in this standard are specified in terms of qualitative degrees of suitability and Levels. The degrees of suitability are defined as:

Satisfactory	Flying qualities clearly adequate for the mission Flight Phase. Desired performance is achievable with no more than minimal pilot compensation
Acceptable	Flying qualities adequate to accomplish the mission Flight Phase, but some increase in pilot workload or degradation in mission effectiveness, or both, exists
Controllable	Flying qualities such that the aircraft can be controlled in the context of the mission Flight Phase, even though pilot workload is excessive or mission effectiveness is inadequate, or both. The pilot can transition from Category A Flight Phase tasks to Category B or C Flight Phases, and Category B and C Flight Phase tasks can be completed.

Level 1 is Satisfactory, Level 2 is Acceptable, and Level 3 is Controllable. In the presence of higher intensities of atmospheric disturbances, 4.9.1 states the relationship between Levels and qualitative degrees of suitability. Where possible, the flying qualities requirements are stated for each Level in terms of limiting values of one or more parameters. Each value, or combination of values, represents a minimum condition necessary to meet one of the three Levels of acceptability.

It is to be noted that Level 3 is not necessarily defined as safe. This is consistent with the Cooper-Harper rating scale: for Cooper-Harper ratings of 8 and 9, controllability may be in question. If safe characteristics are required for Level 3, then action must be taken to improve aircraft flying qualities.

In some cases sufficient data do not exist to allow the specification of numerical values of a flying quality parameter. In such cases it is not possible to explicitly define a quantitative boundary of each Level, so the required Levels are then to be interpreted in terms of qualitative degrees of suitability for the piloting task, appropriate for mission accomplishment.

REQUIREMENT RATIONALE (3.3)

These Levels and degrees of suitability are part of the structure of the standard, and are based on the Cooper-Harper Scale, see figure 6 (NASA-TN-D-5153).

REQUIREMENT GUIDANCE

The related MIL-F-8785C paragraph is 1.5.

Where possible, the requirements of Section 4 have been stated as allowable ranges of the stability or control parameter being specified. Each specified value is a minimum condition to meet one of three Levels of acceptability related to the ability to complete the operational missions for which the aircraft is designed. In actual practice, the flying quality boundaries referred to above were obtained by fairing lines of constant Cooper-Harper pilot rating. Hence it was necessary to define equivalent definitions between the Cooper-Harper scale shown in figure 6 and the Level definitions. Typically, a Cooper-Harper pilot rating of 1 to 3 defines Level 1, a Cooper-Harper rating from 4 through 6 defines Level 2, and a Cooper-Harper rating from 7 through 9 defines Level 3. In a few instances, as indicated in the associated Guidance, the boundaries have been further modified for other considerations. It should be noted that the Level 3 Controllable lower bound, like the other bounds, is sensitive to pilot workload. AFFDL-TR-69-72 shows the assumed correlation of the Cooper-Harper scale with earlier rating scales.

MIL-STD-1797A
APPENDIX A

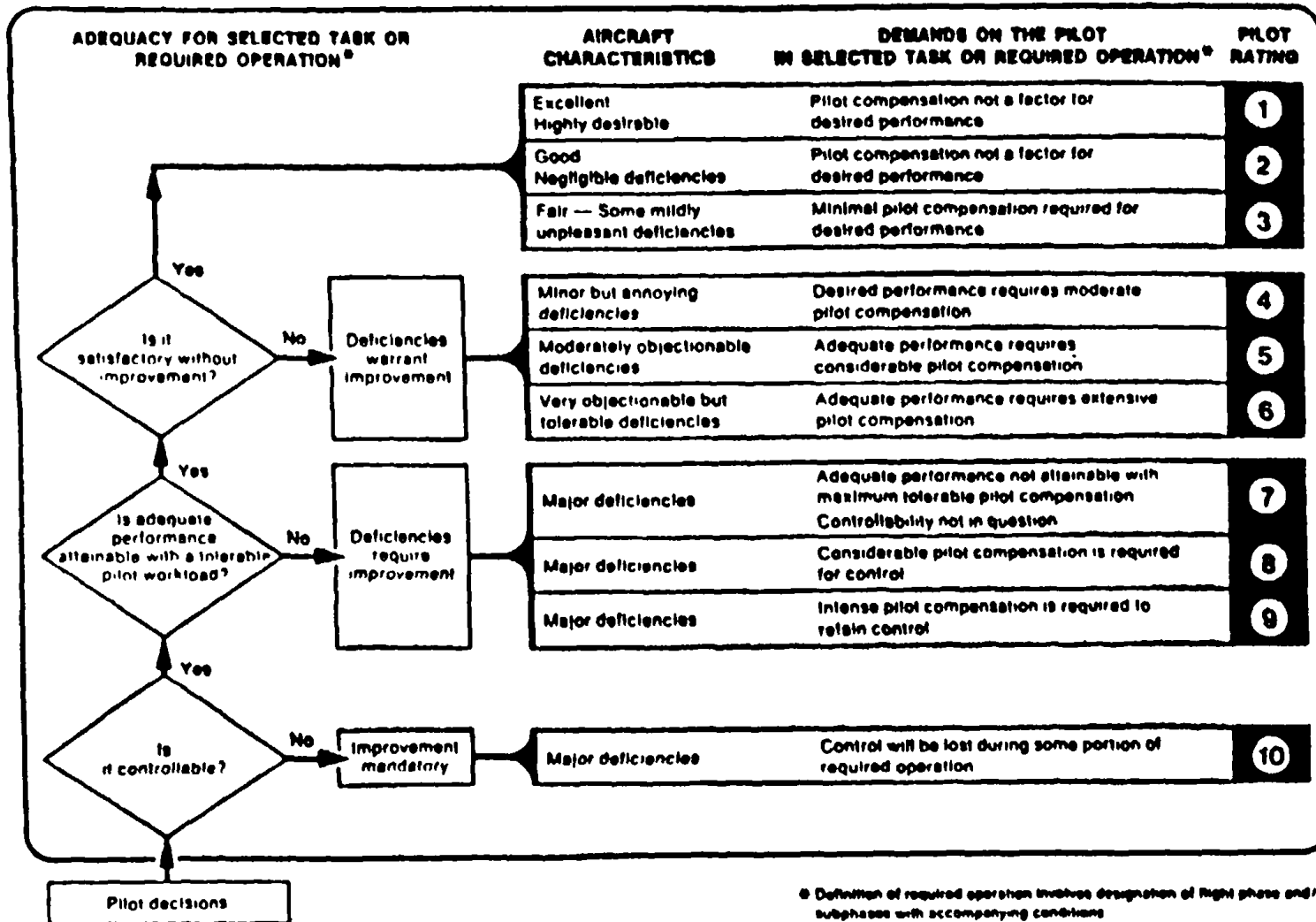

FIGURE 6. Definition of Flying Quality Levels in Calm to Light Turbulence.

MIL-STD-1797A
APPENDIX A

Fractional ratings are to be avoided: Cooper and Harper stress the need for clear choices, especially at the Level boundaries. Wildly scattered ratings should not be averaged: the Cooper-Harper scale is nonlinear. Even for adjacent ratings, caution is needed: variations in pilot technique, disturbance time histories, subjective criteria, etc. may result in valid rating differences.

Relating the Cooper-Harper Pilot Rating Scale to the Levels of flying qualities has the added benefit of more precise definitions which are related to the operational considerations of pilot workload and task performance, as well as making the pilot rating correlations consistent with the Level 1, 2, and 3 criterion boundaries in the flying quality standard. It is especially important to note that "Controllable" is in the context of the Flight Phase: the pilot's other duties must be attended to.

It is natural for pilot rating of flying qualities to degrade with increasing atmospheric disturbances. Since this standard is used to procure aircraft, not pilots, we must distinguish between degradation of pilot rating and degradation of aircraft characteristics. As indicated in the requirement, this distinction is made in 4.9.1 for Normal and Failure States. These allowances, of course, should not be construed as a recommendation to degrade flying qualities with increasing intensities of atmospheric disturbances.

For several reasons we do not use Cooper-Harper ratings directly in the standard:

Level applies to aircraft (which the requirements cover), doing design-mission task. Cooper-Harper (C-H) rating is given by a pilot doing the task with the aircraft in a given environment. Since C-H rating is expected to change with severity of the environment, Levels tied exclusively to C-H ratings would vary with intensity of disturbances--e.g. Level 1 in light turbulence, Level 2 in moderate. That gets cumbersome to call out in requirements, so we need to tie down the environmental severity when determining Levels.

Requirements need to address ability to complete or terminate a Flight Phase, which the C-H ratings don't treat.

We need some leeway for engineering-type input to requirements, e.g. increasing the Level 1 short-period damping boundary to account for more severe turbulence and not allowing negative dutch roll damping even for Level 3.

Some requirements are based on operational experience or need, rather than pilot evaluation--e.g., crosswind landing capability or two-engine-out controllability.

"Deficiencies warrant improvement," from the C-H ratings, just doesn't apply for normal operation between the Operational and Service Flight Envelope boundaries.

In assessing compliance, as well as in design, the firmness of numerical values is preferred to the variability of evaluation-pilot ratings. Thus, even though the final decision to accept or reject will be made on the basis of pilot ratings (as these decisions always have been), more exactly defined boundaries are needed for specification.

Having stated these caveats, we note that given a well-defined task and a "calm to light" environment, the Level definitions do closely correspond to 1 through 3, 4 through 6, and 7 through 9 C-H ratings. Thus, for the qualitative requirements in the proper environment there is a direct correspondence of C-H ratings, to Levels (However it's done, lacking the "design" environment the evaluation pilot must extrapolate). We have modified the Level definitions to be even closer to the C-H definitions.

MIL-STD-1797A
APPENDIX A

REQUIREMENT LESSONS LEARNED

Use of the Cooper-Harper scale is accepted universally as a guide, but only by some as a way to state requirements. Herein we use it as the principal way to relate flying qualities requirements to operational needs. Accounting for the observed effects of atmospheric disturbances in a generally acceptable manner has been quite a problem. The point is that while pilot rating is allowed to degrade in Moderate disturbances, as we must expect, we do not want to allow aircraft characteristics also to degrade, as they might from saturation of stability augmentation or other nonlinearities. That would likely cause a further degradation in pilot rating. Therefore we must somehow make a distinction between Levels and Cooper-Harper ratings; their relationship must vary with the intensity of atmospheric disturbances.

According to figure 6, piloting should not require the pilot's attention to the exclusion of all other duties. If "adequate performance requires moderate [or greater] pilot compensation", the "deficiencies warrant improvement", etc.--all in the full context of the mission including hostile environment, weather, etc. The ratings are meant to apply to the most demanding tasks foreseen, aggressively performed.

40. REQUIREMENTS

4.1 General requirements

4.1.1 Loadings.

The contractor shall define the longitudinal, lateral and vertical envelopes of center of gravity and corresponding weights that will exist for each Flight Phase. Throughout these envelopes shall include the most forward and aft center-of-gravity positions as defined in _____. In addition the contractor shall determine the maximum center-of-gravity excursions attainable through failures in systems or components, such as fuel sequencing or hung stores, for each Flight Phase. Throughout these envelopes, plus a growth margin of _____, and for the excursions cited, this standard applies.

REQUIREMENT RATIONALE (4.1.1)

Since aircraft characteristics vary with loading, limits must be defined and the loadings known at conditions for demonstration of compliance. The loading of an aircraft is determined by what is in (internal loading) and attached to (external loading) the aircraft. The loading parameters that normally define flying qualities are weight, center-of-gravity position, and moments and products of inertia (4.1.2). External stores affect all these parameters and also affect aerodynamic coefficients.

REQUIREMENT GUIDANCE

The related MIL-F-8785C requirement is paragraph 3.1.2.

For normal operation the allowable c.g. range is applicable. Certain failures may cause an adverse c.g. shift. In these cases, the abnormal c.g.'s so attained are applicable.

The requirements apply under all loading conditions associated with an aircraft's operational missions. Since there are an infinite number of possible internal and external loadings, each requirement generally is only examined at the critical loading(s) with respect to the requirement. Only permissible center-of-gravity positions need be considered for Aircraft Normal States. Fuel sequencing, transfer failures or malperformance, and mismanagement that might move the center of gravity outside the established limits are expressly to be considered as Aircraft Failure States. The worst possible cases that are not approved Special Failure States (4.1.7.2) must be examined.

MIL-W-25140 is normally referenced here for consistency.

The procuring activity may elect to specify a growth margin in c.g. travel to allow for uncertainties in weight distribution, stability level and other design factors, and for possible future variations in operational loading and use. Peculiarities of configuration or possible alternative mission tasks may lead to the specification of additional loadings. Fuel slosh and shift under acceleration also need consideration.

It is fairly straightforward to determine those longitudinal flying qualities that set the longitudinal c.g. limits, but there are also cases where the aft c.g. limit may be set by lateral-directional flying qualities. Usually supersonic flight at high dynamic pressure is the most critical, because the level of directional stability is reduced due to Mach number and aeroelastic effects. Conditions to be investigated to ensure acceptable lateral-directional characteristics at the aft limits include:

- a. Roll performance/roll coupling
- b. Abrupt engine loss or inlet unstart at one g
- c. Abrupt engine loss or inlet unstart at high normal acceleration or angle of attack, especially for Class IV aircraft
- d. Turbulence effects

MIL-STD-1797A
APPENDIX A

When evaluating aeroelastic effects and effects of hinge moments due to angle of attack, the pitch and yaw control surface deflection and sideslip must be taken into account. Pitching moment due to sideslip can also be significant on configurations using vortex lift or highly swept wings. The trend toward relaxed lateral-directional stability indicates that the effect of c.g. on low-speed lateral-directional characteristics should also be examined.

This requirement also requires the contractor to define the lateral c.g. limit. This is especially critical for Class IV aircraft. Conditions to evaluate with asymmetric loadings include:

- a. Takeoff with and without crosswind.
- b. Roll performance/roll coupling.
- c. Abrupt engine loss at takeoff and in maneuvering flight.
- d. Dive pullout at high normal acceleration.
- e. Yaw departure at high angle of attack and spin resistance.

In defining this limit, the basic lateral asymmetry due to wing fuel system tolerances and equipment mounted off centerline, such as guns and ammunition, should be taken into account.

REQUIREMENT LESSONS LEARNED

Lateral asymmetries due to fuel loading can have important effects on trim, stall/post-stall characteristics, etc. Fuel system design has been known to promote such asymmetry, for example, at prolonged small sideslip in cruising flight.

Since the requirements apply over the full range of service loadings, effects of fuel slosh and shifting should be taken into account in design. Balance, controllability, and airframe and structure dynamic characteristics may be affected. For example, takeoff acceleration has been known to shift the c.g. embarrassingly far aft. Aircraft attitude may also have an effect. Other factors to consider are fuel sequencing, in-flight refueling if applicable, and all arrangements of variable, disposable and removable items required for each operational mission.

5.1 General requirements

5.1.1 Loadings-verification.

The contractor shall furnish the required loading data in accordance with the Contract Data Requirements List (CDRL).

VERIFICATION RATIONALE (5.1.1)

Aircraft weight and balance are estimated during the design and measured on the vehicle itself.

VERIFICATION GUIDANCE

Once the specific loadings are defined, application of this requirement is straightforward. Provision of this data is usually called out in the CDRL.

The procuring activity will check the material submitted for completeness. Eventually, weight and balance measurements will be made to confirm the estimates. The requirements apply to the actual flight weights and centers of gravity.

VERIFICATION LESSONS LEARNED

MIL-STD-1797A
APPENDIX A

4.1.2 Moments and products of inertia.

The contractor shall define the moments and products of inertia of the aircraft associated with all loadings of 4.1.1. The requirements of this standard shall apply for all moments and products of inertia so defined.

REQUIREMENT RATIONALE (4.1.2)

Inertial characteristics of the aircraft affect its flying qualities, so the contractor must define the inertias for all expected loadings corresponding to possible distributions and the loadings for which flying qualities are evaluated.

REQUIREMENT GUIDANCE

The related MIL-F-8785C requirement is paragraph 3.1.3.

In any dynamic analysis of an aircraft, inertias must be known. The axis system in which the values are given must be identified.

I_{xy} and I_{yz} , normally neglected, may be appreciable for asymmetric loadings.

REQUIREMENT LESSONS LEARNED

5.1.2 Moments and products of inertia-verification.

The contractor shall furnish moments and products of inertia data in accordance with the Contract Data Requirements List (CDRL).

VERIFICATION RATIONALE (5.1.2)

By meticulous accounting of weight and balance, inertia values can be estimated fairly accurately. Except for extremely large aircraft, inertias may be measured with equipment located at the Air Force Flight Test Center, Edwards AFB, CA.

VERIFICATION GUIDANCE

Sufficient data should be supplied in the reports required by the CDRL. The procuring activity may, at its discretion, wish to review the methods used in estimating or measuring the inertial characteristics specified. If deemed necessary, checks of estimates can be made by ground tests (e.g., forced oscillations using equipment such as that at the Air Force Flight Test Center) or parameter estimation from flight test data.

VERIFICATION LESSONS LEARNED

MIL-STD-1797A
APPENDIX A

4.1.3 Internal and external stores.

The symmetric and asymmetric store combinations to be considered are as follows: _____. The requirements of this standard shall apply to these store conditions. The effects of stores on the weight, moments of inertia, center-of-gravity position, and aerodynamic characteristics of the aircraft shall be determined for each mission Flight Phase. When the stores contain expendable loads, the requirements of this standard apply throughout the range of store loadings, including sloshing/shifting.

REQUIREMENT RATIONALE (4.1.3)

Once the procuring activity has specified the stores to be considered, the contractor must assure that evaluation of the aircraft with these store combinations covers all operational flight conditions.

REQUIREMENT GUIDANCE

The related MIL-F-8785C requirement is paragraph 3.1.4.

Stores and stores combinations affect the overall ability of the aircraft to meet its mission requirements. In determining the range of store loadings to be specified in the contract, the procuring activity should consider such factors as store mixes, possible points of attachment, and asymmetries--initial, after each pass, and the result of failure to release. The contractor may find it necessary to propose limitations on store loading to avoid excessive design penalties. Since such limitations are operationally restrictive, the procuring activity may be reluctant to approve them.

The designer should attempt to assure that there are no restrictions on store placement on the aircraft within the range of design stores. However, it is recognized that occasionally this goal will be impracticable on some designs. It may be impossible to avoid exceeding aircraft limits, or excessive design penalties may be incurred. Then, insofar as considerations such as standardized stores permit, it should be made physically impossible to violate necessary store loading restrictions. If this should not be practicable, the contractor should submit both an analysis of the effects on flying qualities of violating the restrictions and an estimate of the likelihood that the restrictions will be exceeded.

Even while the aircraft is in service, other stores will be added. Part of this clearance will be determination of the effect on flying qualities.

See MIL-HDBK-244 for additional requirements and guidance. The most stringent requirement will govern.

REQUIREMENT LESSONS LEARNED

High-angle-of-attack testing conducted on the F-15 (AFFTC-TR-75-32) shows a degradation in flying qualities and departure resistance with external stores. Asymmetric stores and internal fuel asymmetry affected departure and spin characteristics. Stores tests with the F-16 (AFFTC-TR-80-29) show similar results, and serve to illustrate the importance of defining a comprehensive set of conditions for investigating stores effects. For example, during ground taxi of the F-16, "The pilot noticed a leaning or tip-over sensation especially during light weight taxi with a strong crosswind, tight turns, or with asymmetric store loadings."

Stores can have mass, inertial and aerodynamic effects, typically decreasing both longitudinal and directional aerodynamic stability, increasing moments of inertia and the roll-mode time constant, and increasing susceptibility to departure from controlled flight and the difficulty of recovery. The available control power limits the amounts of inertia increase and instability that can be tolerated. Store separation is a prime concern.

For external as well as internal fuel tanks, the critical fuel loading for each requirement applies (see 4.1.1)

MIL-STD-1797A
APPENDIX A

5.1.3 Internal and external stores-verification.

The analysis, simulation and testing to verify compliance with this standard shall include the listed stores. The contractor shall furnish a list of store restrictions in accordance with the Contract Data Requirements List (CDRL)

VERIFICATION RATIONALE (5.1.3)

The c.g. and aerodynamic effects of internal and external stores need to be considered while verifying compliance with the flying qualities requirements.

VERIFICATION GUIDANCE

Often the large number of possible stores combinations will, from a practical standpoint, limit flight demonstration to a few cases. A careful analysis before flight testing will assure that the most critical combinations (from a flying qualities perspective) are being evaluated.

VERIFICATION LESSONS LEARNED

4.1.4 Flight Envelopes.

Three kinds of envelopes are to be defined. They are the Operational Flight Envelope, the Service Flight Envelope, and the Permissible Flight Envelope. As a general policy, the contractor should propose the boundaries and rationale for all envelopes. Additional negotiation between the contractor and flying qualities engineer representing the procuring agency may be required before the boundaries of the flight envelopes can be agreed to by the procuring activity.

At this stage the Flight Phases will also be known from 3.2. In response to these and other requirements the contractor can then design the aircraft and:

Further define the Operational Flight Envelope for each Flight Phase, based on the associated Aircraft Normal States,

Construct the larger Service Flight Envelope for the Aircraft Normal State associated with each Flight Phase, and

Similarly construct portions of the Permissible Flight Envelope boundaries, beyond which operation is not allowed.

Each Envelope must include the flight condition(s) related to any pertinent performance guarantees.

The envelopes are described by the specification of a two-dimensional (speed and load factor) figure representing the conditions where the requirements apply at a given altitude. An example that defines terms for the Operational and Service Envelopes is shown on figure 7. The load factor, n , denotes maneuverability without regard to thrust available, i.e., the flying qualities specification places no requirements on load-factor capability in constant-speed level flight. These Envelopes are defined at various altitudes corresponding to the Flight Phases; thus they could be considered to be three-dimensional.

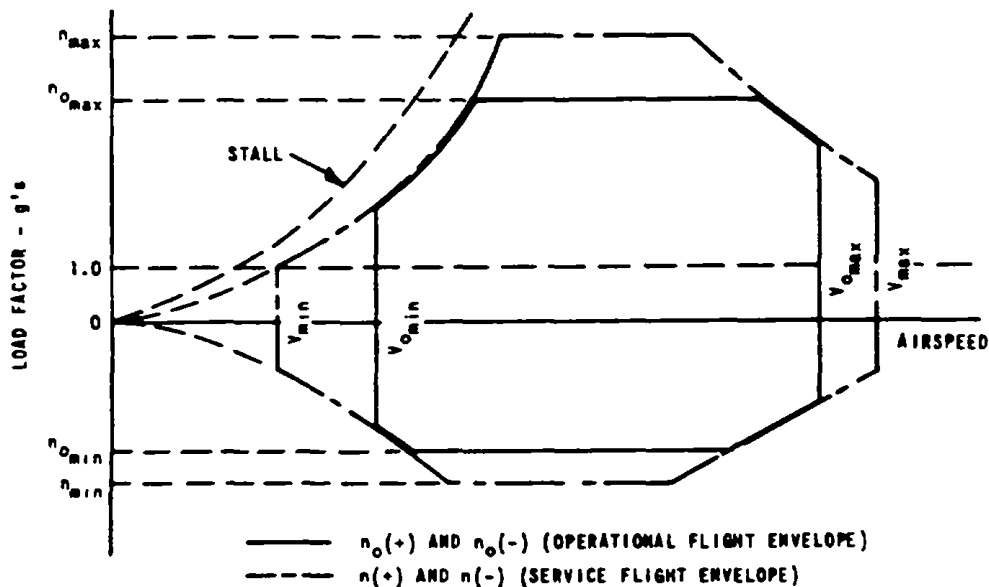

FIGURE 7. Definition of Flight Envelope terms.

For a given design, angle of attack usually will be a more succinct bound than speed, altitude and load factor that vary with gross weight. For relation to aircraft missions the envelopes should be kept in standard V, h, n form, but nominal weight can be used if it and the limit angle of attack are given. Flight testing is likely to use angle of attack directly.

MIL-STD-1797A
APPENDIX A

Some Flight Phases of the same Category will involve the same, or very similar. Aircraft Normal States; so one set of flight envelopes may represent several Flight Phases. Each Flight Phase will involve a range of loadings. Generally, it will be convenient to represent this variation by superimposing boundaries for the discrete loadings of 4.1.1, or possibly by bands denoting extremes. If different external store complements affect the envelope boundaries significantly, it may be necessary for the contractor to construct several sets of envelopes for each Flight Phase, each set representing a family of stores. A manageably small total number of Envelopes should result. It is apparent that the Flight Envelopes must and can be refined, as the design is further analyzed and defined, by agreement between the contractor and the procuring activity.

Flight tests will be conducted to evaluate the aircraft against requirements in known (a priori) Flight Envelopes. Generally, flight test will cover the Service Flight Envelope, with specific tests (stalls, dives, etc.) to the Permissible limits. The same test procedures usually apply in both Service and Operational Envelopes; only the numerical requirements and qualitative Levels differ. If, for example, speed and altitude are within the Operational Flight Envelope but normal load factor is between the Operational and Service Flight Envelope boundaries, the requirements for the Service Flight Envelope apply for Aircraft Normal States.

Ideally, the flight test program should also lead to definition of Flight Envelopes depicting Level 1 and Level 2 boundaries. These Level boundaries should aid the using commands in tactical employment, even long after the procurement contract has been closed out.

Separate Flight Envelopes are not normally required for Aircraft Failure States. It is rational to consider most failures throughout the Flight Envelopes associated with Aircraft Normal States. These may be exceptions (such as a wing sweep failure that necessitates a wing-aft landing, or a flap failure that requires a higher landing speed) that are peculiar to a specific design. In such cases the procuring activity may have to accept some smaller Flight Envelopes for specific Failure States, making sure that these Envelopes are large enough for safe Level 2 or Level 3 operation.

Level 2 flying qualities are required in the Service Flight Envelope. Note, however, that the minimum service speed is a function of stall speed, V_s , and the first item in the definition is based on lift plus thrust component. For STOL or high-thrust-to-weight-ratio configurations, V_s by this definition can be significantly lower than the aerodynamic or power-off stall speed. Other items in the definition of V_s and minimum service speed give a minimum usable speed which could be higher or lower than the aerodynamic stall speed. This applies in level flight and in maneuvers. It is doubtful that this interpretation has in fact been used; however, these are operational benefits to be gained from improving flying qualities at extreme flight conditions. The safe, usable attainment of more extreme flight conditions may be emphasized for missions in which maneuvering at high angle of attack is critical. The procuring activity could accomplish this by, tailoring the requirements for determining the Service and Permissible Flight Envelopes. As an example, we could require that the Permissible Flight Envelope be defined consistent with operational maneuvers appropriate to the mission.

In the roll performance requirements we have felt the need to make a further distinction as a function of airspeed within the Operational and Service Flight Envelopes. The relaxation close to the stall is a concession to aerodynamic realities for roll control via the usual means.

It should also be noted that the boundaries of these envelopes should not be set by ability to meet the flying qualities requirements. The flying qualities requirement should be met within the boundaries which normally are set by other factors, unless specific deviations are granted. The only exception is control power, which may set some boundaries for stable aircraft, if the requirements on the Operational Flight Envelope are still met. The rationale for each type of Envelope is presented in the following discussions of each subparagraph.

The Air Force Flight Test Center has expressed the desirability of more flight testing away from the middle of the flight envelopes, where most of the testing is done.

MIL-STD-1797A
APPENDIX A

4.1.4.1 Operational Flight Envelopes.

The Operational Flight Envelopes define the boundaries in terms of speed, altitude and load factor within which the aircraft must be capable of operating in order to accomplish the missions of 3.1 and in which Level 1 flying qualities are required. These envelopes shall implicitly include the ranges of other parameters, such as sideslip, which may normally be encountered. The range of sideslip or lateral acceleration employed with direct side force control is to be stated explicitly. In the absence of other specific instructions, the contractor shall use the representative conditions of table I for the applicable Flight Phases.

REQUIREMENT RATIONALE (4.1.4.1)

By bounding the envelopes in which the best flying qualities are desired, unnecessary cost, weight, complexity, etc. can be avoided while assuring capability to perform the intended missions.

REQUIREMENT GUIDANCE

The related MIL-F-8785C paragraph is 3.1.7.

Operational Flight Envelopes are regions in speed-altitude-load factor space where it is necessary for an aircraft, in the configuration and loading associated with a given Flight Phase, to have very good flying qualities -- as opposed, for example, to regions where it is only necessary to insure that the aircraft can be controlled without undue concentration. The required size of the Operational Flight Envelopes for a particular aircraft has been given in 3.1; however, this can further be delineated by using table VII for each Flight Phase Category. Additional boundaries will be provided by the contractor.

It has not generally been found necessary to incorporate other flight parameters such as sideslip; the operationally encountered range of such parameters is implicit in the Operational Flight Envelopes. Also, certain requirements specify a sideslip range or capability.

In defining the speed-altitude-load factor combinations to be encompassed, the following factors should be considered:

- a. The Operational Flight Envelope for a given Flight Phase should initially be considered to be as large a portion of the associated Service Flight Envelope as possible, to permit the greatest freedom of use of the aircraft.
- b. The detail specification should be as specific as possible about the speed and altitude ranges over which stated load-factor capabilities are required. Obviously, limit load factor cannot be attained at a lift-limited combat ceiling; but normally it would be insufficient at a much lower altitude to have n_L capability at only one speed.
- c. The Operational Flight Envelopes must encompass the flight conditions at which all appropriate performance guarantees will be demonstrated.
- d. In setting the minimum approach speed, $V_{O_{min}}$ (PA), care should be taken to allow sufficient stall margin. Commonly, $1.2 V_S$ has been used for military land-based aircraft and $1.15 V_S$ for carrier-based aircraft. For reference, FAR Part 25 specifies $1.3 V_S$ for landing-distance calculations; while FAR Part 23 specifies approach at $1.5 V_S$ for these calculations where required. Differences in method of determining stall speed tend to make the FAR Part 25 and military stall margins equivalent; herein V_S is defined at constant airspeed rather than with a slow deceleration.

MIL-STD-1797A
APPENDIX A

Table I. Operational Flight Envelope.

FLIGHT PHASE CATEGORY	FLIGHT PHASE	AIRSPEED		ALTITUDE		LOAD FACTOR	
A							
B							
C							

MIL-STD-1797A
APPENDIX A

TABLE VII. Operational flight Envelope values.

FLIGHT PHASE CATEGORY	FLIGHT PHASE	AIRSPEED		ALTITUDE		LOAD FACTOR	
		$V_{o_{min}} (M_{o_{min}})$	$V_{o_{max}} (M_{o_{max}})$	$h_{o_{min}}$	$h_{o_{max}}$	$n_{o_{min}}$	$n_{o_{max}}$
A	AIR-TO-AIR COMBAT (CO)	$1.15V_S$	V_{MAT}	MSL	Combat Ceiling	-1.0	n_L
	GROUND ATTACK (GA)	$1.3 V_S$	V_{MRT}	MSL	Medium	-1.0	n_L
	WEAPON DELIVERY/LAUNCH (WD)	V_{range}	V_{MAT}	MSL	Combat Ceiling	.5	*
	AERIAL RECOVERY (AR)	$1.2 V_S$	V_{MRT}	MSL	Combat Ceiling	.5	n_L
	RECONNAISSANCE (RC)	$1.3 V_S$	V_{MAT}	MSL	Combat Ceiling	*	*
	IN-FLIGHT REFUEL (RECEIVER) (RR)	$1.2 V_S$	V_{MRT}	MSL	Combat Ceiling	.5	2.0
	TERRAIN FOLLOWING (TF)	V_{range}	V_{MAT}	MSL	10,000 ft	0	3.5
	ANTISUBMARINE SEARCH (AS)	$1.2 V_S$	V_{MRT}	MSL	Medium	0	2.0
	CLOSE FORMATION FLYING (FF)	$1.4 V_S$	V_{MAT}	MSL	Combat Ceiling	-1.0	n_L
B	CLIMB (CL)	$.85 V_{R/C}$	$1.3 V_{R/C}$	MSL	Cruising Ceiling	.5	2.0
	CRUISE (CR)	V_{range}	V_{NRT}	MSL	Cruising Ceiling	.5	2.0
	LOTTER (LO)	$.85 V_{end}$	$1.3 V_{end}$	MSL	Cruising Ceiling	.5	2.0
	IN-FLIGHT REFUEL (TANKER) (RT)	$1.4 V_S$	V_{MAT}	MSL	Cruising Ceiling	.5	2.0
	DESCENT (D)	$1.4 V_S$	V_{MAT}	MSL	Cruising Ceiling	.5	2.0
	EMERGENCY DESCENT (ED)	$1.4 V_S$	V_{max}	MSL	Cruising Ceiling	.5	2.0
	EMERGENCY DECELERATION (DE)	$1.4 V_S$	V_{max}	MSL	Cruising Ceiling	.5	2.0
	AERIAL DELIVERY (AD)	$1.2 V_S$	200 kt	MSL	10,000 ft	0	2.0
C	TAKEOFF(TO)	Minimum Normal Takeoff speed	V_{max}	MSL	10,000 ft	.5	2.0
	CATAPULT TAKEOFF (CT)	Minimum Catapult End Airspeed	$V_{o_{min}} + 30$ kt	MSL	--	.5	n_L
	APPROACH (PA)	Minimum Normal Approach Speed	V_{max}	MSL	10,000 ft	.5	2.0
	WAVE-OFF/GO-AROUND (WO)	Minimum Normal Approach Speed	V_{max}	MSL	10,000 ft	.5	2.0
	LANDING (L)	Minimum Normal Landing Speed	V_{max}	MSL	10,000 ft	.5	2.0

* Appropriate to the operational mission.

MIL-STD-1797A
APPENDIX A

If design tradeoffs indicate that significant penalties (in terms of performance, cost, system complexity, or reliability) are required to provide Level 1 flying qualities in the large envelopes of Items a-d, above, consideration should be given to restricting the Operational Flight Envelope toward the minimum consistent with the requirements of the Flight Phase of the operational mission under consideration.

When effective limiters are employed, Level 1 handling qualities should be provided as close to the limits as practical. Without an effective limiter, graceful degradation is much preferred in order to preclude a flying qualities "cliff."

REQUIREMENT LESSONS LEARNED

Operational missions generally depart significantly from the design mission profile, even for the same type of mission. It is important to allow enough latitude to cover likely variations. Also, over the life of an aircraft its operational missions will likely change in both type and detail. There are, of course, tradeoffs with cost, weight, and the like. For a particular procurement the extent of the Operational Flight Envelope beyond minimum operational needs should be as large, then, as these trades will reasonably permit. While stability and control augmentation can do wonders, such factors as basic control authority and rate, aeroelasticity, and stall speed are (a) limiting at operational extremes and (b) difficult and costly to change after the design freeze. Skimping on Operational Envelopes, then, can cause difficulties.

There is no connotation that operation is limited to the Operational Flight Envelopes. Operational Flight Envelopes is a name, the best we could find, for the region in which the best flying qualities are required. Some pilots have objected that air combat routinely involves flight at lower speeds and higher angles of attack, even post-stall. It has never been our intent (or indeed within our power) to preclude such operational use where it is safe. For a particular procurement, requirements outside the Operational Flight Envelope may warrant strengthening where needs can be identified.

5.1.4 Flight Envelopes-verification

5.1.4.1 Operational Flight Envelopes-verification.

The contractor shall submit the Operational Flight Envelopes for approval by the procuring activity in accordance with the Contract Data Requirements List.

VERIFICATION RATIONALE (5.1.4.1)

The boundaries of these envelopes will be a competitive consideration, so the contractor can expect to be held to them once they are established.

VERIFICATION GUIDANCE

Definition of Operational Flight Envelopes is basic to application of the flying qualities requirements.

VERIFICATION LESSONS LEARNED

MIL-STD-1797A
APPENDIX A

4.1.4.2 Service Flight Envelopes.

For each Aircraft Normal State the contractor shall establish, subject to the approval of the procuring activity, Service Flight Envelopes showing combinations of speed, altitude, and normal acceleration derived from aircraft limits as distinguished from mission requirements. These envelopes shall implicitly include the ranges of other parameters, such as sideslip, which can be expected within the speed, altitude and load-factor bounds. For each applicable Flight Phase and Aircraft Normal State, the boundaries of the Service Flight Envelopes can be coincident with or lie outside the corresponding Operational boundaries.

REQUIREMENT RATIONALE (4.1.4.2)

The Service Flight Envelope encompasses the Operational Flight Envelope for the same Flight Phase and Aircraft Normal State. Its larger volume denotes the extent of flight conditions that can be encountered without fear of exceeding aircraft limitations (safe margins should be determined by simulation and flight test). At least Level 2 handling qualities are required for normal operation. This allows a pilot to accomplish the mission Flight Phase associated with the Aircraft Normal State although mission effectiveness or pilot workload, or both, may suffer somewhat.

This Envelope is also intended to help insure that any deterioration of handling qualities will be gradual as flight progresses beyond the limits of the Operational Flight Envelope. This serves two purposes. It provides some degree of mission effectiveness for possible unforeseen alternate uses of the aircraft, and it also allows for possible inadvertent flight outside the Operational Flight Envelope.

REQUIREMENT GUIDANCE

The related MIL-F-8785C paragraphs are 3.1.8, 3.1.8.1, 3.1.8.2, 3.1.8.3, and 3.1.8.4.

As with the Operational Flight Envelopes, a range of other flight parameters such as sideslip is implicit. For the Service Flight Envelope this range should be derived from aircraft limits as distinguished from mission requirements.

The boundaries of the Service Flight Envelopes are to be based on the speed, altitude, and load factor considerations discussed below and sketched in figure 7.

1. Maximum Service Speed

The maximum service speed V_{max} or M_{max} , for each altitude is the lowest of:

- a. The maximum speed at which a safe margin exists from any potentially dangerous flight condition.
- b. A speed which is a safe margin below the speed at which intolerable buffet or structural vibration is encountered.

In setting the maximum service speed, the designer need not consider speed-altitude combinations that can only be reached in an attitude that would not permit recovery to level flight with a nominal 2000 foot clearance above sea level while remaining within the Permissible Flight Envelope

2. Minimum Service Speed

The minimum service speed, V_{min} or M_{min} , for each altitude is the highest of:

- a. $1.1 V_S$
- b. $V_S + 10$ knots equivalent airspeed

MIL-STD-1797A
APPENDIX A

- c. The speed below which full aircraft-nose-up pitch control power and trim are insufficient to maintain straight, steady flight.
- d. The lowest speed at which level flight can be maintained with MRT.
- e. A speed limited by reduced visibility or an extreme pitch attitude that would result in the tail or aft fuselage contacting the ground.

For engine failure during takeoff, the Standard requires control at speeds down to V_{\min} (TO); but requirements for engine-out climb capability are left to performance specifications.

3. Maximum Service Altitude

The maximum service altitude, h_{\max} , for a given speed is the maximum altitude at which a rate of climb of 100 feet per minute can be maintained in unaccelerated flight with maximum augmented thrust (MAT)

4. Service Load Factors

Maximum and minimum service load factors, $n(+)$ [$n(-)$], are to be established as a function of speed for several significant altitudes. The maximum [minimum] service load factor, when trimmed for 1 g flight at a particular speed and altitude, is the lowest [highest] algebraically of:

- a. The positive [negative] structural limit load factor.
- b. The steady load factor corresponding to the minimum allowable stall warning angle of attack (4.8.4.2).
- c. The steady load factor at which the pitch control is in the full aircraft-nose-up [nose-down] position.
- d. A safe margin below [above] the load factor at which intolerable buffet or structural vibration is encountered.

REQUIREMENT LESSONS LEARNED

Rarely has a military aircraft been used only for its design missions. Examples are plentiful: The P-47, designed as a high-altitude fighter but used more extensively in a ground support role; the B-47 and B-52, designed for high-altitude penetration and bomb-drop from level flight, but later assigned low-level penetration and toss delivery as well; the F-4, early assigned a Navy interceptor role but then used as an all-purpose fighter, and by the Air Force as well; the F-15 and F-16, designed as air superiority fighters but now also flown heavily loaded with external stores for dive bombing; the C-5, with largely unused capability for low-level penetration and forward-base operation.

In general, experience strongly indicates the significant benefits to be had from providing at least acceptable, if not satisfactory, flying qualities up to safe margins from stall, limit dive speed, etc. The capability to use all the performance fallout outside the design mission envelope can greatly enhance the worth of any military aircraft. A significant additional benefit is the promotion of graceful degradation rather than flying qualities "cliffs", for which everything is fine right up to the boundary for departure from controlled flight.

MIL-STD-1797A
APPENDIX A

5.1.4.2 Service Flight Envelopes-verification.

The contractor shall submit the required data for approval by the procuring activity in accordance with the Contract Data Requirements List.

VERIFICATION RATIONALE (5.1.4.2)

Definition of Service Flight Envelopes is basic to application of the flying qualities requirements.

VERIFICATION GUIDANCE

The size of Service Flight Envelopes may be a secondary competitive consideration.

VERIFICATION LESSONS LEARNED

MIL-STD-1797A
APPENDIX A

4.1.4.3 Permissible Flight Envelopes.

The contractor shall define Permissible Flight Envelopes, subject to the approval of the procuring activity, which encompass all regions in which operation of the aircraft is both allowable and possible, and which the aircraft is capable of safely encountering. These Envelopes define boundaries in terms of speed, altitude, load factor, and any other flight limits.

REQUIREMENT RATIONALE (4.1.4.3)

This is a flight safety consideration.

REQUIREMENT GUIDANCE

The related MIL-F-8785C paragraph is 3.1.9.

Basically, the Permissible Flight Envelope is designed such that, from all points within it, ready and safe return to the Service Flight Envelope is possible without exceptional pilot skill or technique, regardless of component or system failures. Structural limits on other flight parameters such as sideslip or lateral acceleration must also be (a) observed and (b) readily complied with. The requirements on stall, spin, and dive characteristics, or dive recovery devices, and on approach to dangerous flight conditions also apply, although Level 2 flying qualities (for Aircraft Normal States) are not required there.

The maximum permissible speed in dives or level flight (the F-103 could reach V_{max} in a climb), and the minimum permissible speed in level flight, can and must be defined for pilots' information. Additionally, some minimum airspeed may need to be defined for zooms, to assure recoverability. For maneuvers such as spins, no minimum permissible speed is normally stated; one accepts the low airspeed attained in the maneuver, satisfactory recovery being the only criterion.

To specify these considerations the contractor must, as a minimum, define the boundaries given below.

1. Maximum Permissible Speed

The maximum permissible speed for each altitude shall be the lowest of:

- a. Limit speed based on structural considerations.
- b. Limit speed based on engine considerations.
- c. The speed at which intolerable buffet or structural vibration is encountered.

In setting the maximum permissible speed, the designer need not consider speed-altitude combinations that can only be reached in an attitude that would not permit recovery to level flight with a nominal 2000 foot clearance above sea level while remaining within the Permissible Flight Envelope. To allow for inadvertent excursions beyond placard speed, some margin should be provided between the maximum permissible speed and the high-speed boundaries of the Operational and Service Flight Envelopes. Such a margin is not specified because no satisfactory general requirement could be formulated. However, for specific designs, the procuring activity should consider 1.1 V_H (commonly used for structural specifications) or the upset requirements of FAR Part 25 and Advisory Circular AC 25-253-IA.

2. 1-g Minimum Permissible Speed

Where maximum lift determines minimum speed, the minimum permissible speed in 1-g flight is V_S as defined in 3.4.2. In general, this is fundamentally more an angle-of-attack limit than an airspeed limit. For some aircraft, considerations other than maximum lift determine the minimum permissible speed in 1-g flight [e.g., ability to perform altitude corrections, excessive sinking speed, ability to execute a waveoff (go-around), etc.]. In such cases an arbitrary angle-of-attack limit, or similar minimum speed and maximum

MIL-STD-1797A
APPENDIX A

load factor limits, shall be established for the Permissible Flight Envelope, subject to the approval of the procuring activity. This defined minimum permissible speed is to be used as V_S in all applicable requirements. V_S needs to be consistent with that used for performance, structure, etc. requirements.

REQUIREMENTS LESSONS LEARNED

For both combat and training missions, flight outside the Service Flight Envelope may well be routine. The new flying qualities requirements that apply there are largely qualitative. Nevertheless these areas can be important parts of a useful flight envelope, or may be reached inadvertently, and so need careful consideration.

5.1.4.3 Permissible Flight Envelopes-verification.

The contractor shall provide the required data for approval by the procuring activity, in accordance with the Contract Data Requirements List.

VERIFICATION RATIONALE (5.1.4.3)

Definition of Permissible Flight Envelopes is basic to application of the flying qualities requirements.

VERIFICATION GUIDANCE

The Permissible Flight Envelopes will be refined as better analysis, simulation and test data become available.

VERIFICATION LESSONS LEARNED

MIL-STD-1797A
APPENDIX A

4.1.5 Configurations and States of the aircraft.

The requirements of this standard apply for all configurations required or encountered in the applicable Flight Phases of 3.2. A selected configuration is defined by the positions and adjustments of the various selectors and controls available to the crew except for pitch, roll, yaw, throttle and trim controls. Examples are: the flap control setting and the yaw damper ON or OFF. The selected configurations to be examined must include those required for performance demonstration and mission accomplishment. Additional configurations to be investigated are defined as follows: _____. Switches which activate stability augmentation necessary to meet the requirements of this standard are considered always to be ON unless otherwise specified. The State of the aircraft is defined by the selected configuration together with the functional status of each of the aircraft components or systems, throttle setting, weight, moments of inertia, center-of-gravity position, and external store complement. The trim setting and the position of the pitch, roll, and yaw controls are not included in the definition of Aircraft State since they are often specified in the requirements.

REQUIREMENT RATIONALE (4.1.5)

The requirement is intended to assure that all expected aircraft configurations and states are defined and considered, and that the conditions for compliance are sufficiently called out. All aircraft configurations either necessary or likely to be encountered must be evaluated.

REQUIREMENT GUIDANCE

The related MIL-F-8785C requirements are paragraphs 3.1.5 and 3.1.6.

The designer must define the configuration or configurations which his aircraft will have during each Flight Phase. This includes the settings of such controls as flaps, speed brakes, landing gear, wing sweep, high lift devices, and wing incidence that are related uniquely to each aircraft design. The requirement specifies that the configurations to be examined shall include those required for performance demonstration and mission accomplishment. The position of yaw, roll, pitch, trim controls, and the thrust setting are not included in the definition of configuration since the positions of these controls are usually either specified in the individual requirements or determined by the specified flight conditions.

The requirements are stated for Aircraft States and Flight Phases, rather than for aircraft configurations. The flying qualities should generally be a function of the job to be done rather than of the configuration of the aircraft. Special considerations or features may require investigation of additional configurations. These paragraphs introduce the Aircraft State terminology for use in the requirements.

REQUIREMENT LESSONS LEARNED

MIL-STD-1797A
APPENDIX A

5.1.5 Configurations and States of the aircraft-verification.

The contractor shall furnish a list of aircraft configurations in accordance with the Contract Data Requirements List.

VERIFICATION RATIONALE (5.1.5)

Definition of aircraft states is basic to application of the flying qualities requirements.

VERIFICATION GUIDANCE

This is defined by the requirement itself, and by any specific requirements from the procuring activity.

VERIFICATION LESSONS LEARNED

MIL-STD-1797A
APPENDIX A

4.1.6 Aircraft Normal States.

The contractor shall define and tabulate all pertinent items to describe the Aircraft Normal States (no component or system failure) associated with each of the applicable Flight Phases. This tabulation shall be in the format and use the nomenclature of table II. Certain items, such as weight, moments of inertia, center-of-gravity position, wing sweep, or thrust setting may vary continuously over a range of values during a Flight Phase. The contractor shall replace this continuous variation by a limited number of values of the parameter in question which will be treated as specific States, and which include the most critical values and the extremes encountered during the Flight Phase in question.

REQUIREMENT RATIONALE (4.1.6)

Definition of normal aircraft states is basic to application of the flying qualities requirements.

REQUIREMENT GUIDANCE

The related MIL-F-8785C paragraphs are 3.1.6.1 and 4.2.

It is possible that items not normally considered, such as setting or automatic operation of engine bypass doors, can affect flying qualities.

The contractor is required to define the Aircraft Normal States for each applicable Flight Phase, in the format of table II. If the position of any particular design feature can affect flying qualities independently of the items in table II, its position should be tabulated as well. Initially, variable parameters should be presented in discrete steps small enough to allow accurate interpolation to find the most critical value, or combinations for each requirement; then those critical cases should be added. As discussed under 4.1.1 through 4.1.3, center-of-gravity positions that can be attained only with prohibited, failed, or malfunctioning fuel sequencing need not be considered for Aircraft Normal States.

REQUIREMENT LESSONS LEARNED

5.1.6 Aircraft Normal States-verification.

The contractor shall furnish a list of Aircraft Normal States in accordance with the Contract Data Requirements List.

VERIFICATION RATIONALE (5.1.6)

Definition of normal aircraft states is basic to application of the flying qualities requirements.

VERIFICATION GUIDANCE

Definition of normal aircraft states is basic to application of the flying qualities requirements.

VERIFICATION LESSONS LEARNED

4.1.6.1 Allowable Levels for Aircraft Normal States.

Flying qualities for Aircraft Normal States within the Operational Flight Envelope shall be Level 1. Flying qualities for Aircraft Normal States within the Service Flight Envelope but outside the Operational Flight Envelope shall be Level 2 or better. To account for the natural degradation of pilot-vehicle performance and workload in intense atmospheric disturbances, the requirements of 4.1.6.1 through 4.1.6.3 are adjusted according to 4.9.1.

4.1.6.2 Flight outside the Service Flight Envelopes.

From all points in the Permissible Flight Envelopes and outside the Service Flight Envelopes, it shall be possible readily and safely to return to the Service Flight Envelope without exceptional pilot skill or technique. The requirements on flight at high angle of attack, dive characteristics, dive recovery devices and dangerous flight conditions shall also apply in all pertinent parts of the Permissible Flight Envelopes.

4.1.6.3 Ground operation.

Some requirements pertaining to taxiing, takeoffs, and landing involve operation outside the Operational, Service, and Permissible Flight Envelopes, as at V_S or on the ground. When requirements are stated at conditions such as these, the Levels shall be applied as if the conditions were in the Operational Flight Envelopes.

REQUIREMENT RATIONALE (4.1.6.1 - 4.1.6.3)

Levels of flying qualities as indicated in 3.3 apply generally within the Operational and Service Flight Envelopes. Some basic requirements, generally qualitative in nature, apply in both the Operational and Service Flight Envelopes. Provision must also be made for expected and allowable operation outside these envelopes.

REQUIREMENT GUIDANCE

The related MIL-F-8785C requirements are paragraphs 3.1.10, 3.1.10.1, 3.1.10.3.1, 3.1.10.3.2, 3.1.10.3.3, 3.8.3, and 3.8.3.1.

Aircraft Normal States include both all-up operation and degradations/failures that are sufficiently probable to be considered Normal. See 4.1.7 and 4.1.7.1 for guidance on the latter.

Note that flying qualities which "warrant improvement" according to figure 6 nevertheless meet all the requirements if they only occur outside the Operational Flight Envelope.

Where Levels are not specified, care should be taken in selecting requirements from this handbook that will not overburden the designer. We have tried to keep the impact of 4.1.6.1 in mind in writing the recommended material to fill in the blanks, but qualitative words such as "objectionable" must be taken in the context of relevance to operational use.

Since there are few requirements in Aircraft Failure States outside the Service Flight Envelope, implicit assumptions for 4.1.6.2 are that:

Failures at these conditions are very rare, or

Not-so-rare failures at these conditions are manageable

Given one or more failures within the Service Flight Envelope which would have serious consequences beyond, at a minimum the crew would be warned away from danger (4.1.8).

Similar assumptions apply for 4.1.6.3. In any given case, their validity will need to be checked.

MIL-STD-1797A
APPENDIX A

REQUIREMENT LESSONS LEARNED

5.1.6.1 Allowable Levels for Aircraft Normal States-verification.

Verification shall be by analysis, simulation and test.

5.1.6.2 Flight outside the Service Flight Envelopes-verification.

Verification shall be by analysis, simulation, and test.

5.1.6.3 Ground operation-verification.

Verification shall be by analysis, simulation, and test.

VERIFICATION RATIONALE (5.1.6.1 - 5.1.6.3)

These paragraphs are needed to guide the application of the rest of the requirements.

VERIFICATION GUIDANCE

Compliance will be shown in demonstrating compliance with the other requirements of the standard.

VERIFICATION LESSONS LEARNED

MIL-STD-1797A
APPENDIX A

4.1.7 Aircraft Failure States.

The contractor shall define and tabulate all Aircraft Failure States which can affect flying qualities. Aircraft Failure States consist of Aircraft Normal States modified by one or more malfunctions in aircraft components or systems; for example, a discrepancy between a selected configuration and an actual configuration. Those malfunctions that result in center-of-gravity positions outside the center-of-gravity envelope defined in 4.1.1 shall be included. Each mode of failure shall be considered in all subsequent Flight Phases.

REQUIREMENT RATIONALE (4.1.7)

This tabulation is the starting point for a failure modes and effects analysis, which is necessary in a complex aircraft to assure flying qualities adequate for mission effectiveness and flight safety.

REQUIREMENT GUIDANCE

The related MIL-F-8785C paragraph is 3.1.6.2.

Because of the exhaustive work often involved and low confidence in the failure probability calculations, there is a tendency for the procuring activity to substitute a priori list of specific failures. If a design is far enough along and not excessively complex, such an approach can work. See the guidance for 4.1.7.1. However, generally comprehensive reliability analyses will be required anyway.

Whether the approach to failure effects on flying qualities is probabilistic, generic or a combination, failure possibilities of the specific aircraft must be catalogued thoroughly enough to assure adequate mission effectiveness and flight safety.

REQUIREMENT LESSONS LEARNED

There is more to determining Failure States than just considering each component failure in turn. Two other types of effects must be considered. First, failure of one component in a certain mode may itself induce other failures in the system, so failure propagation must be investigated. Second, one event may cause loss of more than one part of the system or can affect all channels: a broken bracket, a single crack, a fire, in electrical short, inadequate ground checkout, etc.. The insidious nature of possible troubles emphasizes the need for caution in design applications.

5.1.7 Aircraft Failure States-verification.

The contractor shall furnish the required data in accordance with the Contract Data Requirements List.

VERIFICATION RATIONALE (5.1.7)

Definition of aircraft failure states is basic to the application of the flying qualities requirements.

VERIFICATION GUIDANCE

Generally, compliance will amount to identifying pertinent items from the list required by the reliability specification, and checking for completeness. Although the task may seem formidable, the alternative to a thorough review is a certainty that something important will be overlooked.

VERIFICATION LESSONS LEARNED

4.1.7.1 Allowable Levels for Aircraft Failure States.

Higher performance of aircraft has led to ever-expanding Flight Envelopes, increased control system complexity, and the necessity to face the problem of equipment failures in a realistic manner. The specification of Levels corresponding to Failure States is directed at the achievement of adequate flying qualities without imposing undue requirements that could lead to unwarranted system complexity or decreased flight safety. For example, an aircraft with two separate pitch controllers is safer from the standpoint of controller jam but the probability of such a failure is higher. Without actually requiring a good-handling basic airframe, the standard demands:

High probability of good flying qualities where the aircraft is expected to be used.

Acceptable flying qualities in reasonably likely, yet infrequently expected, conditions.

A floor to assure, to the greatest extent possible, at least a flyable aircraft no matter what failures occur.

A process to assure that all the ramifications of reliance on powered controls, stability augmentation, etc., receive proper attention.

Two options are presented to allow the procuring agency to quantitatively specify the allowable degradation in flying qualities due to failure states. The first option is unchanged from MIL-F-8785C. It involves the following failure probability calculations:

Identify those Aircraft Failure States which have a significant effect on flying qualities (4.1.7).

Calculate the probability of encountering various Aircraft Failure States, per flight.

Determine the degree of flying qualities degradation associated with each Aircraft Failure State.

Compute the total probability of encountering Level 2 and 3 flying qualities in the Operational Flight Envelope. This total will be the sum of the probability of each failure if the failures are statistically independent.

With this method, requirements still remain on the flying qualities effects of certain specific failures, e.g. engine and flight control system failures.

The second option assumes that certain listed failures and combinations of failures will occur sometime (with probability 1). As in Option 1, the degraded flying qualities for each selected Failure State are then evaluated. This approach is referred to as generic failure analysis. Option 2 is provided to allow a formal Handbook requirement that reflects a current practice. The procuring activity may in fact require probability calculations for certain axes or system components and a generic failure analysis for others. The generic failure analysis therefore encompasses the requirements for specific failures of MIL-F-8785C (3.1.10.2.1)

Generally, the requirements consider only degradations in a single flying quality. It should be recognized that degradations in several flying qualities parameters can have an effect worse than any one of those degradations. However, data definitive enough for a standard are not available.

Note that the factors called out in 4.1.11.5 Control margin include Aircraft Failure States and maneuvering flight appropriate to the Failure States.

MIL-STD-1797A
APPENDIX A

4.1.7.2 Aircraft Special Failure States.

Certain components, systems, or combinations thereof may have extremely remote probabilities of failure during a given flight. The failures may, in turn, be very difficult to predict with any degree of accuracy. Special Failure States of this type need not be considered in complying with the requirements of this standard, if justification for considering them as Special Failure States is submitted by the contractor and approved by the procuring activity.

REQUIREMENT RATIONALE (4.1.7.1 - 4.1.7.2)

Perfection is not a realistic expectation. This requirement is to determine the practical limits in each case.

REQUIREMENT GUIDANCE

The related MIL-F-8785C paragraph is 3.1.6.2.1.

In most cases, a considerable amount of engineering judgment will influence the procuring activity's decision to allow or disallow a proposed Aircraft Special Failure State. Probabilities that are extremely remote are exceptionally difficult to predict accurately. Judgments will weigh consequences against feasibility of improvement or alternatives, and against projected ability to keep high standards throughout design, qualification, production, use, and maintenance. Meeting other pertinent requirements--MIL-F-87242, AFGS-87221, etc.--should be considered, as should experience with similar items. Generally, Special Failure States should be brought to the attention of those concerned with flight safety.

Note that the required approval of Aircraft Special Failure States, in conjunction with Level 3 floors and certain requirements that must be met regardless of component or equipment status, can be used as desired: for example to require a level of stability for the basic airframe, limit use of stick pushers to alleviate pitch-up, disallow rudder-pedal shakers for stall warning, rule out fly-by-wire control systems, require an auxiliary power source, force consideration of vulnerability, etc. The procuring activity should state those considerations they wish to impose, as completely as they can, at the outset; but it is evident that many decisions must be made subjectively and many will be influenced by the specific design.

Several categories of Special Failure States can be distinguished. Certain items might be approved more or less categorically:

- Control-stick fracture.
- Basic airframe or control-surface structural failure.
- Dual mechanical failures in general.

Regardless of the degree of redundancy, there remains a finite probability that all redundant paths will fail. A point of diminishing returns will be reached, beyond which the gains of additional channels are not worth the associated penalties:

- Complete failure of hydraulic or electrical, etc., systems.
- Complete or critical partial failure of stability augmentation that has been accepted as necessary to meet Level 3.

Some items might be excepted, if special requirements are met. For example, some limited control should remain after failure of all engines, provided by accumulators or an auxiliary power source as appropriate.

In the last analysis the procuring activity is responsible for approving design tradeoffs that bear upon safety. Rather than inhibiting imaginative design, then, this paragraph should be construed as forcing examination of failure possibilities as they affect flight safety through deterioration of flying qualities. The present state of the art can support some properly implemented reliance on stability augmentation to maintain Level 3 flying qualities, but it must be done carefully and for good reason.

MIL-STD-1797A
APPENDIX A

Concerning the admissibility of a Special Failure State on the basis of its remoteness of possibility, the combined probability of having any flying qualities worse than Level 3--not just each individual Failure State probability--must be kept extremely remote.

REQUIREMENT LESSONS LEARNED

By default, all failure modes not considered become Special Failure States, albeit without specific approval

5.1.7.1 Allowable Levels for Aircraft Failure States-verification

5.1.7.2 Aircraft Special Failure States-verification.

The contractor shall submit the required data in accordance with the Contract Data Requirements List, for review by the procuring activity.

VERIFICATION RATIONALE (5.1.7.1 - 5.1.7.2)

Definition of Aircraft Special Failure States is basic to application of the flying qualities requirements.

VERIFICATION GUIDANCE

Definition of Aircraft Special Failure States is basic to application of the flying qualities requirements.

VERIFICATION LESSONS LEARNED

MIL-STD-1797A
APPENDIX A

4.1.7.3 Probability calculation.

When Aircraft Failure States (4.1.7) exist, a degradation in flying qualities is permitted only if the probability of encountering a lower Level than specified is sufficiently small. The contractor shall determine, based on the most accurate available data, the probability of occurrence of each Aircraft Failure State per flight within the Operational and Service Flight Envelopes. These determinations shall be based on _____ except that:

- a. All aircraft systems are assumed to be operating for the entire flight, unless clearly operative only for a shorter period
- b. For these calculations, the length of flight shall be hours
- c. Each specific failure is assumed to be present at whichever point in the Flight Envelope being considered is most critical (in the flying qualities sense).

From these Failure State probabilities and effects, the contractor shall determine the overall probability, per flight, that one or more flying qualities are degraded to Level 2 because of one or more failures. The contractor shall also determine the probability that one or more flying qualities are degraded to Level 3. These probabilities shall be less than the values shown in table III.

TABLE III. Levels for Aircraft Failure States.

PROBABILITY OF ENCOUNTERING	WITHIN OPERATIONAL FLIGHT ENVELOPE	WITHIN SERVICE FLIGHT ENVELOPE
Level 2 after failure	< _____ per flight	
Level 3 after failure	< _____ per flight	< _____ per flight

REQUIREMENT RATIONALE (4.1.7.3)

This requirement provides a sound analytical method for accounting for the effects of failures. It serves to force a detailed failure mode and effect analysis from the flying qualities standpoint. Such an analysis is vital as both system complexity and the number of design options increase.

The probability of a degraded Level of flying qualities is related to, but not exactly the same as, mission or flight-safety reliability. A degraded flying qualities Level is allowed for some infrequently expected events failure of aircraft systems or flight outside the Operational Flight Envelope, near the aircraft's limits (by definition, the Operational Flight Envelopes encompass the design missions).

REQUIREMENT GUIDANCE

The related MIL-F-8785C requirement is paragraph 3.1.10.2, which calls for determinations to be based on MIL-STD-756.

As in MIL-F-8785C, failure probabilities are specified as a function of number of flights, rather than flight hours. As discussed in "Supporting Data," a typical flight time of four hours was used for the MIL-F-8785B numbers. The numbers in table VIII, while arbitrary, were chosen so that failures which degrade flying qualities would not contribute disproportionately to reduction or loss of mission effectiveness, or to flight safety problems. The form is consistent with failure rate data, which usually are presented per flight hour,

MIL-STD-1797A
APPENDIX A

and with the critical takeoff and landing Flight Phases, which occur once per flight. It is implied that, while mission duration varies among aircraft types, the number of missions does not. The flight length of a normal long mission, with in-flight refueling if appropriate, should be specified.

TABLE VIII. Recommended Levels for Aircraft Failure States.

PROBABILITY OF ENCOUNTERING	WITHIN OPERATIONAL FLIGHT ENVELOPE	WITHIN SERVICE FLIGHT ENVELOPE
Level 2 after failure	<10 ⁻² per flight	-----
Level 3 after failure	<10 ⁻⁴ per flight	<10 ⁻² per flight

For comparison, MIL-F-9490 recommends the following unreliability allowance for the entire flight control system, manual and automatic, with somewhat different ground rules:

- Mission accomplishment: < 10⁻³ per flight
- Flight safety: < 5 x 10⁻⁷ per flight, Class III;
< 10⁻⁵ per flight, Classes I, II, IV

FAR Part 25 paragraph 25.671, by comparison for the flight control system:

- Probable malfunctions > 10⁻³ per hour are allowed to have only minor effect
- Extremely improbable failures < 10⁻⁹ per hour need not be considered
- Continued safe flight and landing must be assured after all other failures/combinations.

Limited degradation of flying qualities (e.g., Level 1 to Level 2) is acceptable if the combined probability, of such degradation is small. If the probability of any particular failure is high, then that failure must produce no degradation beyond the Level required for Normal States. Another way of stating this would be that in the Operational Envelope the probability of encountering Level 2 any time at all on a given flight should not, according to the table VIII recommendations, exceed 10⁻² and the probability of encountering Level 3 on any portion of the flight should not exceed 10⁻⁴. Somewhat reduced requirements are to be imposed for flight within the Service Flight Envelope, for both Normal and Failure States. Outside the Service Flight Envelope, most of the requirements of the standard do not apply. There is, however, a qualitative requirement to be able to return to the Service Flight Envelope after a failure (i.e., Paragraph 4.1.7.6).

The numbers are given as orders of magnitude. When predicting the occurrence of events of such small probability, that is about the most accuracy that can be expected.

The requirements do not account for the expectation that degradation of more than one flying quality will be more severe than any of those degradations singly. In the absence of a definitive data base, simulation is recommended.

Degradation in atmospheric disturbances is discussed in Requirement Guidance for 4.9.1

The probability of flying qualities degradation is influenced by a number of factors such as design implementation and complexity (including reconfiguration capability), computer reliability improvements,

MIL-STD-1797A
APPENDIX A

lightning protection, built-in test (BIT), maintenance practices and dispatch rules. Peacetime vs. wartime operation can be a necessary concern, although battle damage is a separate consideration.

The numerical values in table III should reflect specific requirements for a given weapon system. The procuring-activity engineer should, as a matter of course, confer with both the using-command representative and the reliability engineers to assure that the probabilities associated with the Levels are consistent with the overall design goals. However, the recommended values of table IV are reasonable, based on experience with past aircraft and current and projected states of the art. To illustrate this, the following listing presents actual control system failure information for several piloted aircraft:

Reference	System	Mean Time Between Malfunctions (MTBM)
Bureau of Naval Weapons Failure Rate Data Handbook	F-101B	86 hours
	F-104	300 hours
	F-105D(Fit cntl + elect)	14 hours
	E-1B	185 hours
Ad Hoc Committee Report on B-58 Controllability in Flight	B-58	20 hours
MODAS	F-16A	48 hours
	F-16B	40 hours
	F-16C	66 hours
	F-16D	68 hours
	KC-10A	130 hours
	A-10A	70 hours
	F-4C	26 hours
	F-4D	22 hours
	F-4E	22 hours
	F-4G	17 hours
	F-15C	49 hours
	B-1	8 hours

MODAS stands for Maintenance and Operational Data Access Systems, a system the Air Logistics Centers use to record and document failures of aircraft systems. The tabulated MODAS data from early 1986 are for type 1 flight control system failures only, not including the autopilot.

Unfortunately the flying qualities effects of the reported failures are not given along with the above data. A Second Analysis of B-58 Flight Control System Reliability indicates, however, that the mean time between critical failures is about five times the MTBM. If critical failures are ones that degrade one or more flying qualities to Level 2, then for a typical average flight time of four hours:

MIL-STD-1797A
APPENDIX A

$$\begin{aligned}
 P(\text{Level 2}) &= \text{Probability of encountering Level 2 flying qualities during a single flight} \\
 &= 1 - e^{-4/[5(\text{MTBM})]} \\
 &\doteq \frac{4}{5(\text{MTBM})}
 \end{aligned}$$

This yields:	System	P(Level 2)
	F-101B	0.0093
	F-104	0.0027
	F-105D	0.0570
	E-1B	0.0043
	B-58	0.0400
	F-16A	0.0167
	F-16B	0.0200
	F-16C	0.0121
	F-16D	0.0118
	KC-10A	0.0062
	A-10A	0.0114
	F-4C	0.0308
	F-4D	0.0364
	F-4E	0.0364
	F-4G	0.0471
	F-15C	0.0163
	B-1	0.1000

These data indicate that most systems have $P(\text{Level 2}) \approx 10^{-2}$ or less (or approximately one out of a hundred flights). We consider the F-16, A-10, and F-15 to meet the requirement, considering the limited accuracy of probability calculations. For the F-105, F-4, and B-1, the data may include failures in electronic components which do not result in degradation of flying qualities. Numbers of roughly the same magnitude have been used for both American (Tentative Airworthiness Objectives and Standards for Supersonic Transport Design Proposals) and Anglo-French (Supersonic Transport Aeroplane Flying Qualities) supersonic transport design.

A more significant analysis was conducted on the F-4 by the Air Force Flight Dynamics Laboratory (AFFDL-FGC-TM-71-7). The level of degradation used in this report was based on whether or not the failure resulted in an abort. Failures without abort were considered degraded to Level 2, and those which caused an abort were considered degraded to Level 3. The results showed that the F-4 handling qualities, in an average 2.57 hour flight, will be degraded to Level 2 on an average of 0.043/flight, and to Level 3 a maximum of 0.0021/flight (21×10^{-4}).

A similar comparison can be made between accident loss rates and the requirement for $P(\text{Level 3}) < 2.5 \times 10^{-5}$ /flight hour. The Level 3 boundaries are, while not necessarily totally safe, at least safety related. General Dynamics Rpt FZM-12-2652 indicates the following aircraft accident loss rates during 1967. Also, shown is the probability of aircraft loss, per 4-hour flight, for an assumed exponential loss distribution.

MIL-STD-1797A
APPENDIX A

Aircraft	1967 loss rate (Losses/100,000 hr)	probability of loss during 4-hour flight
F-101	15	6×10^{-4}
F-104	23	9.2×10^{-4}
F-105	17	6.8×10^{-4}
F-106	10	4×10^{-4}
F-4	14.1	5.64×10^{-4}
F-102	9	3.6×10^{-4}
F-100	10	4×10^{-4}
Avg	14	5.6×10^{-4}

If Level 3 represented a safety problem, which it conservatively does not, then the allowable 10^{-4} probability of encounter per 4-hour flight would account for about 1/4 to 1/9 of the total probability, of aircraft loss. That is, flying-qualities-oriented losses would represent about 1/4 to 1/9 of all losses. Other losses could be due to engine failures, etc. Therefore, based on experience the recommended table VIII value is reasonable.

As a final note, "Industry Observer" from Aviation Week and Space Technology of 1 April 1968 indicates an Army aircraft accident rate of 22.2/100,000 hours which is very close to the previously cited experience with a number of Air Force aircraft.

REQUIREMENT LESSONS LEARNED

The following excerpts were taken from written comments made by ASD regarding lessons learned utilizing Paragraph 3.1.10.2 of MIL-F-8785B.

F-16:	Levels were applied to failures without calculating probabilities; assumed that if a failure could occur, it would eventually (i.e., generic failure analyses)
F-15, F-16, F-105:	Low confidence in failure probability calculations; better to consider individual failures (i.e., generic failure analyses)
B-1/AMST:	See ASD-TR-78-13 for approach to failure states taken on B-1 and AMST. Probability analysis was used. B-1 experience with its longest mission (10-hours) indicated that meeting the probability of encountering Level 3 of 10^{-4} /flight [as required in MIL-F-8785B] was not possible at that time, with that design concept.
F-15, A-10:	Very hard to determine realistic probabilities; recommend defining special failure states from past experience (i.e., generic failure analyses)
A-10:	Only specific failures were investigated (i.e., generic failure analyses); most of front section of specification not really used.
F-5E:	Flight outside the Operational Flight Envelope should not be considered abnormal; Paragraph 3.1.10.2 of MIL-F-8785B deleted as useless.

MIL-STD-1797A
APPENDIX A

See also REQUIREMENT LESSONS LEARNED for 4.1.7.4.

Other problems with this approach are:

- a. The scatter in the MTBM data for various components can provide large uncertainty in the calculation of probability of failure in the system.
- b. Systems change all through the design, ground and flight test process. Therefore, the number of components and their arrangement change significantly. This approach requires that failure possibilities and modes, and probabilities of failure, be reevaluated after each design change.

5.1.7.3 Probability calculation-verification.

The contractor shall submit the required data in accordance with the Contract Data Requirements List.

VERIFICATION RATIONALE (5.1.7.3)

This approach addresses the reliability of flying qualities, rather than the reliability of hardware and software per se.

Until some time downstream in the design process, the flight control and related subsystems will not be defined in enough detail to permit a comprehensive listing of failure possibilities, much less to estimate their likelihood. Initially, this requirement serves as guidance in selecting a design approach and components and redundancy levels which can potentially achieve or surpass the stated probabilities of not encountering the degraded Levels. As the design progresses, reliability analyses and failure mode and effect analyses will provide the means of determining compliance.

VERIFICATION GUIDANCE

The discussions that follow are taken from AFFDL-TR-69-72.

Implementation of the Level concept involves both reliability analyses (to predict failure probabilities) and failure effect analyses (to insure compliance with requirements). Both types of analyses are in direct accord with, and in the spirit of, MIL-STD-756B and MIL-STD-882B. These related specifications are, in turn, mandatory for use by all Departments and Agencies of the Department of Defense. Implementation of the flying qualities specification is, for the most part, a union of the work required by these related specifications with normal stability and control analysis.

Failure States influence the aircraft configurations, and even the mission Flight Phases, to be considered. All failures that could have occurred previously must be examined, as well as all failures which might occur during the Flight Phase being analyzed. For example, failure of the wings to sweep forward during descent would require consideration of a wings-aft landing that otherwise would never be encountered. There are failures that would always result in an aborted mission, even in a war emergency. The pertinent Flight Phases after such failures would be those required to complete the aborted (rather than the planned) mission. For example, failure of the flaps to retract after takeoff might mean a landing with flaps at the takeoff setting, with certain unexpended external stores; but supersonic cruise would be impossible. If the mission might be either continued or aborted, both contingencies need to be considered.

There are some special requirements pertaining to failure of the engines and the flight control system. For these special requirements the pertinent failure is assumed to occur (with a probability of 1), with other failures considered at their own probabilities. For all other requirements, the actual probabilities of engine and flight control system failure are to be accounted for in the same manner as for other failures.

Note that specific Special Failure States (4.1.7.2) may be approved; these Failure States need not be considered in determining the probability of encountering degradation to Level 3. This allows each

MIL-STD-1797A
APPENDIX A

catastrophic failure possibility to be considered on its own. Requiring approval for each Special Failure State gives the procuring activity an opportunity to examine all the pertinent survivability and vulnerability aspects of each design. Survivability and vulnerability are important considerations, but it has not yet been possible to relate any specific flying qualities requirements to them.

For electronic components, MIL-HDBK-217 provides reliability data. There seems to be no standard source for reliability data on other components.

A typical approach (but not the only one) for the system contractor is outlined below. The stages indicated are appropriate for the required calculation and submittal.

1. Initial Design

The basic airframe is designed for a Level 1 target in respect to most flying qualities in the Operational Flight Envelope. It may quickly become apparent that some design penalties would be inordinate (perhaps to provide sufficient aerodynamic damping of the short period and dutch roll modes at high altitude); in those cases the basic airframe target would be shifted to Level 2. In other cases it may be relatively painless to extend some Level 1 flying qualities over the wider range of the Service Flight Envelope. Generally the design will result in Level 1 flying qualities in some regions and, perhaps, Level 2 or Level 3 in others. Augmentation of one form or another (aerodynamic configuration changes, response feedback, control feed forward, signal shaping, etc.) would be incorporated to bring flying qualities up to Level 1 in the Operational Flight Envelope and to Level 2 in the Service Flight Envelope.

2. Initial Evaluation

The reliability and failure mode analyses are next performed to evaluate the nominal system design evolved above. All aircraft subsystem failures that affect flying qualities are considered. Failure rate data for these analyses may be those specified in the related specifications, other data with supporting substantiation and approval as necessary, or specific values provided by the procuring agency. Prediction methods used will be in accordance with related specifications. The results of this evaluation will provide: a) a detailed outline of design points that are critical from a flying qualities/flight safety standpoint; b) quantitative predictions of the probability of encountering Level 2 in a single flight within the Operational Flight Envelope, Level 3 in the Operational Envelope, and Level 3 in the Service Envelope; and c) recommended airframe/equipment changes to improve flying qualities or increase subsystem reliability to meet the specification requirements. It should be noted that the flying qualities/flight safety requirements are concerned with failure mode effects, while MIL-STD-785 provides "basic" reliability requirements per se (all failures regardless of failure effects). In the event of a conflict, the most stringent requirement would apply.

3. Re-Evaluation

As the system design progresses, the initial evaluation is revised at intervals. This process continues throughout the design phase, with review by the procuring activity at times consonant with other reviewer activity.

The results of the analyses of vehicle flying qualities/flight safety may be used directly to: a) establish flight test points that are critical and should be emphasized in the flight test program; b) establish pilot training, requirements for the most probable, and critical, flight conditions; and c) provide guidance and requirements for other subsystem designs.

The failure modes and effects analysis (MIL-STD-1629) will highlight items which need to be checked by piloted simulation and flight test--although safety considerations may limit flight test. Further, compliance is demonstrated on the basis of the probability calculations and checked as accumulated flight experience permits. All of the assumptions, such as independence of failure modes, etc., should be firmly established

MIL-STD-1797A
APPENDIX A

and mutually agreed upon by the contractor and SPO. The combined effects of turbulence and failures should also be considered. The boundaries given in figure 8 have been suggested as guidelines for these combined effects, but the recommended approach is to relax the requirements according to 4.9.1.

The combined effects of failures and turbulence should be validated in a manned simulation. Multiple-axis failures should also be simulated, especially where the flying quality parameters result in pilot ratings near the applicable Level's lower limits.

Proof of compliance is, for the most part, analytical in nature as far as probabilities of failure are concerned. However, some failure rate data on the actual flight equipment may become available during final design phases and during flight test, and any data from these or other test programs should be used to further demonstrate compliance. Stability and control data of the usual type (e.g., predictions, wind tunnel, flight test) will also be used to demonstrate compliance. Finally, the results of all analyses and tests will be subject to normal procedures of procuring agency approval.

MIL-STD-1797A
APPENDIX A

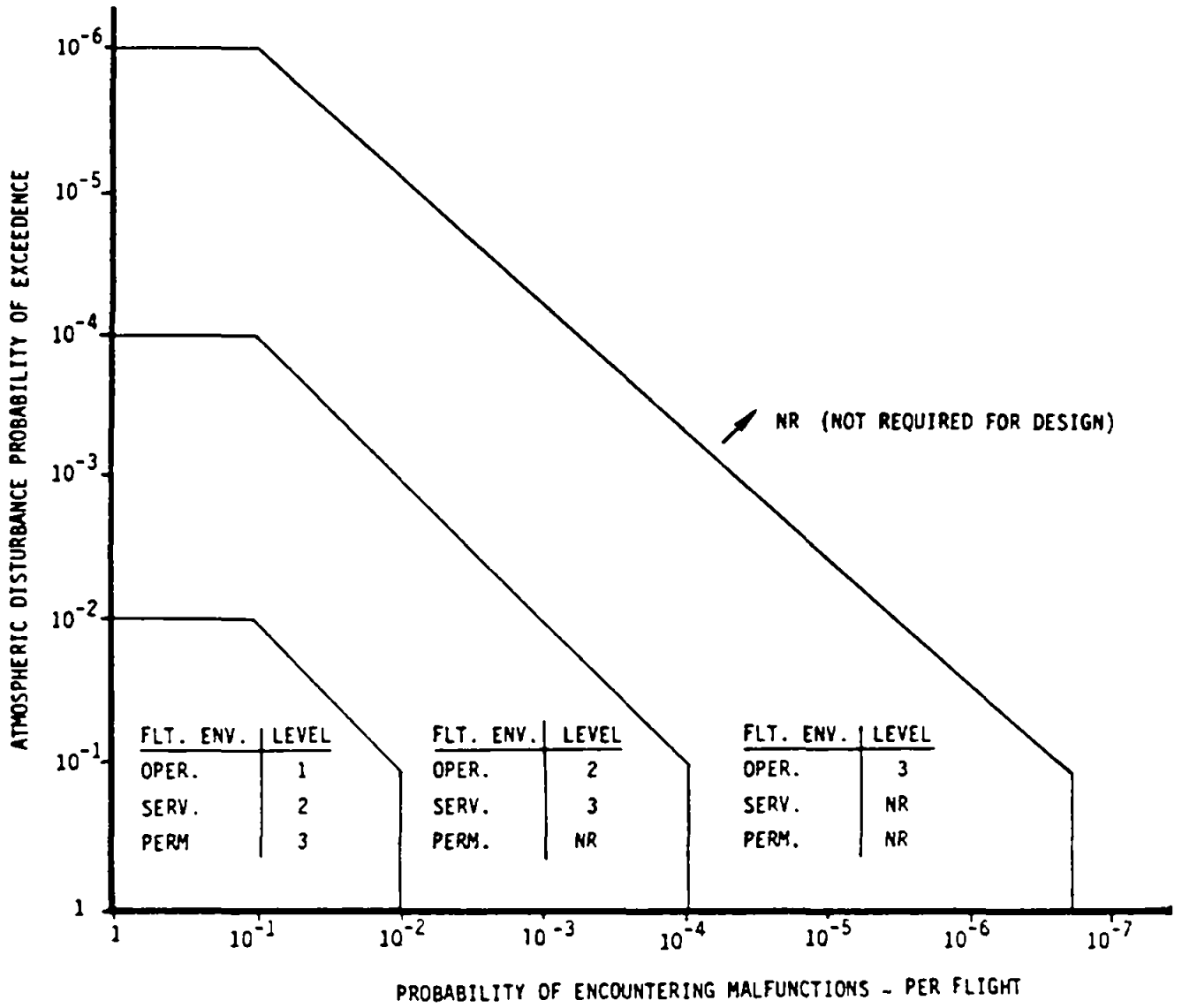

FIGURE 8. Definition of Levels which include atmospheric disturbances as well as failures -- suggested by Carlson (AFFDL-TR-78-171).

VERIFICATION LESSONS LEARNED

MIL-STD-1797A
APPENDIX A

4.1.7.4 Generic failure analysis.

The requirements on the effects of specific types of failures, for example propulsion or flight control system, shall be met on the basis that the specific type of failure has occurred, regardless of its probability of occurrence. The requirements of this standard on failure transients shall also be met. The allowable flying quality Levels for each of the Failure States in 4.1.7 are defined as follows: _____ . In addition, flying qualities in the following specific failure states shall be as follows:

Failure	Level
_____	_____

REQUIREMENT RATIONALE (4.1.7.4)

In accordance with the lessons learned of 4.1.7.3, this paragraph has been included to provide a way to specify the allowable degradation in handling qualities due to failures without making detailed probability calculations.

This approach assumes that a given component, or series of components, will fail. Furthermore, the failures are assumed to occur in the most critical flight condition; for example, a yaw damper failure at the maximum service ceiling in turbulence. Based on the comments made by users of MIL-F-8785B (see Lessons Learned in 4.1.7.3), this approach is a common current practice.

REQUIREMENT GUIDANCE

The related MIL-F-8785C requirement is paragraph 3.1.10.2.1.

The selection of failures to be considered is based on preliminary estimates of handling quality degradations. For example, the loss of one to three channels of a quad-redundant SCAS may have no effect. Conversely the failure of a single-channel, limited-authority damper would warrant a complete analysis, possibly simulation too, to determine the resulting degradation in flying qualities. Requirements such as two-fail-operate assume a certain degree of reliability and so may penalize either the manufacturer or the user. In addition, the procuring activity may wish to demand that certain specific failures be considered regardless of their probabilities.

Because the selection of failure modes is highly dependent on the details of the design, close coordination between the contractor and the procuring activity will be required when identifying failure modes to be analyzed and determining the allowable degradation. Indeed, this is currently practiced.

A comprehensive failure mode and effect analysis has been found essential for all but very simple designs. The questions here are how to force this analysis and how to treat the flying qualities aspects.

When writing a generic failure requirement, it is best to associate the required Levels of flying qualities with the number of failures in the system, and the tasks that must be performed, e.g.:

MIL-STD-1797A
APPENDIX A

	Failure State	Flight Phase	Level
1.	After two independent failures in the stability/control augmentation system	All	1
2.	After two independent failures in the air data system	RR,CR,PA,L	2
3.	After two independent failures in the electrical power system	RR,CR,PA,L	2
4.	After loss of all propulsion power, means shall be provided to maintain stable and controlled flight for the time required to descend from cruise altitude to sea level at the speed for best L/D, with a 5 minute reserve	ED,L	2
5.	After 2 independent failures in a system (such as a fuel system) which can affect center of gravity position	All	2
6.	Electrical power interrupts or transients shall not result in excessive aircraft transients or result in loss of controlled flight	All	2
7.	After 1 failure in the hydraulic system	All	2

It must be emphasized that this is only an example. There may be failures that are not discussed in this example, such as generic software faults; Levels of flying qualities for these failure modes should be negotiated with the contractor and coordinated with each of the technical disciplines involved.

The reader is directed to the specific flying qualities requirements which must be met in the event of failures. Paragraphs 4.2.6.1, 4.2.8.6.5, 4.5.7.1, 4.5.9.5.6, and 4.6.7.9 concern flight control system failures; while 4.5.8.4, 4.5.9.5.5, 4.6.5.1, 4.6.6.2 and 4.6.7.8 concern engine failures. Requirements on failure transients include 4.1.12.8, 4.2.6.1, 4.5.7.1 and 4.6.5.2.

REQUIREMENT LESSONS LEARNED

This approach has been utilized on the F-15 (a Level 2 basic airframe was specified), F-16 (a minor flight control system change from the prototype), A-10 (a simple flight control system design), and F-5E (a design evolution) with reasonable success.

As an example of this process, in one case a failure requirement for the hydraulic system was stated as: "After loss of one hydraulic system, flying qualities sufficient to return to base and land shall remain (Level 2)". A flying qualities analysis was performed to determine the control capability with a reduced number of control surfaces. It was found that if one hydraulic system provided power to an aileron on one side of the vehicle, the elevator on the opposing side, and the rudder, sufficient control could be maintained to land the vehicle. This was confirmed on a piloted simulator. The hydraulic system was plumbed accordingly and demonstrated on the Iron Bird. As the flight test program progressed, modifications were made to the flight control laws and the aerodynamic data package. Furthermore, there were also some slight changes made to the actuators. At the end of the test period, the flying qualities were reevaluated on the simulator to ensure that the vehicle could be landed. This data was then used to verify specification compliance.

MIL-STD-1797A
APPENDIX A

5.1.7.4 Generic failure analysis-verification.

The contractor shall submit the required data in accordance with the Contract Data Requirements List.

VERIFICATION RATIONALE (5.1.7-4)

Verification of generic failure analysis is required to demonstrate that flying qualities parameters in question fall within prescribed boundaries for specified levels when generic failures, as specified in 4.1.7.4, occur.

VERIFICATION GUIDANCE

In most cases, demonstration of compliance will consist of showing that the flying qualities parameters in question fall within the prescribed boundaries for specified Levels. Where numerical boundaries are not available, either ground-based or in-flight simulation will be required. Failures in more than one axis that cause the specified flying quality parameters to fall near the boundaries of more than one flying qualities requirement should also be simulated. Finally, the combined effects of failures and turbulence should be investigated utilizing a piloted simulation.

VERIFICATION LESSONS LEARNED

See 4.1.7.3.

MIL-STD-1797A
APPENDIX A

4.1.7.5 When Levels are not specified.

Within the Operational and Service Flight Envelopes, all requirements that are not identified with specific Levels shall be met under all conditions of component and system failure except approved Aircraft Special Failure States (4.1.7.2).

REQUIREMENT RATIONALE (4.1.7.5)

A number of basic requirements, generally qualitative in nature, apply regardless of Failure State, in both the Operational and Service Flight Envelopes.

REQUIREMENT GUIDANCE

The related MIL-F-8785C paragraph is 3.1.10.3.2.

In view of this necessary gap-filling requirement, care should be taken in selecting requirements from this Handbook that will not overburden the designer. We have tried to keep the impact of 4.1.7.5 in mind in writing the recommended material to fill in the blanks, but qualitative words such as "objectionable" must be taken in the context of the relative likelihood of failure and relevance to operational use.

REQUIREMENT LESSONS LEARNED

5.1.7.5 When Levels are not specified-verification.

Verification shall be by analysis, simulation and flight test.

VERIFICATION RATIONALE (5.1.7.5)

A failure modes and effects analysis will show conditions critical to particular requirements.

VERIFICATION GUIDANCE

Verification will require qualitative evaluation.

VERIFICATION LESSONS LEARNED

MIL-STD-1797A
APPENDIX A

4.1.7.6 Failures outside the Service Flight Envelopes.

Failures to be considered outside the Service Flight Envelopes but within the corresponding Permissible Flight Envelopes are _____. After these failures it shall be possible to return safely to the Service and Operational Flight Envelopes.

REQUIREMENT RATIONALE (4.1.7-6)

Air combat may require short excursions to angles of attack beyond stall, or the normal limit angle of attack, frequently enough to warrant special consideration. Other tasks and ground operation may be pertinent.

REQUIREMENT GUIDANCE

The related MIL-F-8785C paragraph is 3.1.10.3.3.

The other post-stall requirements rely on the basic airframe, the flight control system specification, the presumed small chance of failure in the post-stall region, and avoiding the region if certain Aircraft Failure States exist. New emphasis on post-stall technology now gives added importance to this flight region for certain combat aircraft. At this stage the only guidance possible is to raise the issue and to list some factors in avoiding loss of control:

- Engine: flameout, duty cycle or throttle usage, compressor stall
- Reaction controls
- Fail operate or fail soft
- Frequency of failure
- Failure-warning reliability.

REQUIREMENT LESSONS LEARNED

As for normal operation, stability-augmentation failure modes can have completely different effects in the post-stall region from their action in normal flight envelopes.

5.1.7.6 Failures outside the Service Flight Envelope-verification.

The contractor shall review the list furnished by the procuring activity and through its own analysis modify and extend that list as necessary for adequate coverage of flying qualities degradations, subject to procuring activity approval, in accordance with the Contract Data Requirements List. Verification of safe return capability shall be by analysis, simulation and flight test.

VERIFICATION RATIONALE (5.1.7-6)

Flight safety will be a prime factor in determining the means of verification.

VERIFICATION GUIDANCE

Outside the Service Flight Envelope, wind tunnel tests, structural analyses, propulsion limits, etc., will need to be taken into account.

VERIFICATION LESSONS LEARNED

4.1.8 Dangerous flight conditions.

Dangerous conditions may exist at which the aircraft should not be flown. When approaching these flight conditions, it shall be possible by clearly discernible means for the pilot to recognize the impending dangers and take preventive action. Whenever failures occur that require or limit any flight crew action or decision concerning flying the aircraft, the crew member concerned shall be given immediate and easily interpreted indication.

4.1.8.1 Warning and indication.

Warning and indication of approach to a dangerous condition shall be clear and unambiguous. For example, a pilot must be able to distinguish readily among stall warning (which requires pitching down or increasing speed), Mach buffet (which may indicate a need to decrease speed), and normal aircraft vibration (which indicates no need for pilot action).

4.1.8.2 Devices for indication, warning, prevention, and recovery.

It is intended that dangerous flight conditions be eliminated and the requirements of this standard be met by appropriate aerodynamic design and mass distribution, rather than through incorporation of a special device or devices. As a minimum, these devices shall perform their function whenever needed but shall not limit flight within the Operational Flight Envelope. Neither normal nor inadvertent operation of such devices shall create a hazard to the aircraft. For Levels 1 and 2, nuisance operation shall not be possible. Functional failure of the devices shall be indicated to the pilot.

REQUIREMENT RATIONALE (4.1.8 - 4.1.8.2)

Approach to any dangerous flight condition must be clearly apparent to the pilot with sufficient margin (time, control power, etc.) to avoid loss of control. That, together with limiting the frequency of encounter, is the essence of flight safety as it involves flying qualities.

REQUIREMENT GUIDANCE

The related MIL-F-8785C paragraphs are 3.4.1, 3.4.1.1, 3.4.1.2 and 3.4.9.

The need for warning may not become apparent until late in the development program (or after it), and each such device will generally have to be tailored to a specific set of conditions. These requirements clearly apply to stall warning and prevention devices, as well as to other types.

Certain failures may require restriction of the flight envelope in order to assure safety after the failure, or in the event of a subsequent failure. The flight crew needs to be made aware when such a situation exists.

One possible source of danger is the use of special, unconventional control modes for certain tasks. Under stress, a pilot may forget and revert to the normal technique or exceed a limit. For example, a yaw pointing mode might generate excessive sideslip at low dynamic pressure or too much lateral acceleration at high dynamic pressure. Also, partially or fully automatic modes of flight need to be examined for possible hazards.

Normally, a reasonably reliable limiter or warning need not be redundant. If the pilot knows that the device is inoperative, he can stay well clear of the danger. Nuisance operation not only interferes with mission performance; it breeds disregard or disconnection. Reliance is placed on the flight control system specification and other specifications and standards to assure sufficient reliability of these devices, warning of their failure, and checkout provisions.

Requirement 4.1.8.2 is designed to discourage prevention devices that create more problems than they solve.

Testing will be necessary to assure that the limiting or warning is satisfactory in all maneuvers and that functional failure of any such devices is indicated to the pilot. Ultimately, flight testing will be required (see, for example, MIL-S-83691).

MIL-STD-1797A
APPENDIX A

REQUIREMENT LESSONS LEARNED

Stall limiters have proved to be of significant help, as with the F-101B Boundary Control System and the F-16 stall, load factor and roll limiter, which allow carefree maneuvering up to the set limits. However, an undefeatable limiter is hard to design. If a dangerous pitch-up or locked-in deep stall lurks beyond, some pilot will encounter it if that's possible. Indeed pilots would rather bend the wings than hit the ground, so a soft limiter may be in order. On the other hand, makers and flyers of aircraft with no post-stall limitations (e.g., T-38/F-5, F-15) find these extreme angles of attack useful occasionally in air combat.

Several C-133 losses over oceans were conjectured to have resulted from starting long-range cruise too close to stall, with no stall warning and a severe rolloff in a power-on stall. The artificial stall warning often was turned off because it was not reliable.

F-16s have been lost in ground attack runs because of deteriorated aerodynamics with external stores. The fix was to change the limits when air-to-ground stores are carried. Although the F-16 uses a pilot-operated switch, this can be done automatically, so that the pilot does not have to remember to switch.

5.1.8 Dangerous flight conditions-verification.

Verification shall be by analysis, simulation, and ground and flight testing.

5.1.8.1 Warning and indication-verification.

Verification shall be by analysis, simulation, and ground and flight testing.

5.1.8.2 Devices for indication, warning, prevention, and recovery-verification.

Verification shall be by analysis, simulation, and ground and flight testing.

VERIFICATION RATIONALE (5.1.8 - 5.1.8.2)

In the end, the procuring and test activities must assess the degree of danger and their test pilots must pass on the acceptability of devices and aircraft characteristics.

VERIFICATION GUIDANCE

FTC-TIH-79-2, FTC-TD-73-2, and USNTPS-FTM-103 contain guidance on flight testing for stall/post-stall and other conditions of concern. MIL-S-83691 is an Air Force flight test specification and MIL-D-8708 the corresponding Navy specification.

VERIFICATION LESSONS LEARNED

MIL-STD-1797A
APPENDIX A

4.1.9 Interpretation of subjective requirements.

In several instances throughout the standard, subjective terms, such as objectionable flight characteristics, realistic time delay, normal pilot technique and excessive loss of altitude or buildup of speed, have been employed where insufficient information exists to establish absolute quantitative criteria. Final determination of compliance with requirements so worded will be made by the procuring activity.

REQUIREMENT RATIONALE (4.1.9)

This statement is included to clarify the authority of the procuring activity in determining compliance with subjective requirements. These requirements bear on significant mission effectiveness and flight safety considerations in areas where data are lacking to establish quantitative requirements.

REQUIREMENT GUIDANCE

The related MIL-F-8785C paragraph is 3.1.11.

While subjective requirements permit wide latitude for the contractor in the early stages, the focus in the flying qualities specifications has been, and will continue to be, on quantifying all requirements for which sufficient data exists. The procuring activity should always have final power in accepting compliance with subjective requirements.

REQUIREMENT LESSONS LEARNED

Validity of ground-based and in-flight simulations should be examined as closely as possible. For example it is not entirely clear whether failure of moving-base simulation to predict YF-17 pilot-induced oscillation tendencies prior to flight was due to simulator limitations or inaccurate representation of the flight control system as actually flown. In-flight simulation inaccuracies can also cause discrepancies, viz. the NT-33 simulation which predicted worse AFTI-F-16 ratings than the pilots actually gave the airplane. The cause was traced to modeling error. The dynamics of ground-based simulators (motion, visual scene, computation time, etc.) in general are poorly documented.

5.1.9 Interpretation of subjective requirements-verification.

Verification shall be by analysis, simulation and test.

VERIFICATION RATIONALE (5.1.9)

Verification will require qualitative evaluation.

VERIFICATION GUIDANCE

The procuring activity will rely heavily upon comments by evaluation pilots during simulations, and later during flight tests, in determining compliance with subjective requirements.

In a draft of flying qualities for military rotorcraft, Hoh, and others, supplement the requirements on rotorcraft characteristics with required pilot ratings plus desired and adequate performance in a list of task related demonstration maneuvers (rapid hovering turn, lateral unmask and remask, etc.). These maneuvers, which are spelled out in some detail, are to be performed by several pilots. While such added requirements would be of limited help in the design stage, they would verify the suitability of both qualitative and quantitative flying qualities for the intended missions.

VERIFICATION LESSONS LEARNED

MIL-STD-1797A
APPENDIX A

4.1.10 Interpretation of quantitative requirements.

Many of the numerical requirements of this standard are stated in terms of a linear mathematical description of classical aircraft. Certain factors, for example flight control system nonlinearities and higher-order dynamics or aerodynamic nonlinearities, can cause an appreciable difference in the aircraft response apparent to the pilot from that of the linear model of the basic airframe. The contractor shall determine equivalent classical systems which have responses most closely, matching those of the actual aircraft. Then those numerical requirements of section 4 which are stated in terms of linear system parameters (such as frequency, damping ratio and modal phase angles) apply to the parameters of that equivalent system rather than to any particular modes of the higher-order system representation. The adequacy of the response match between equivalent and actual aircraft, or alternative criteria, shall be agreed upon by the contractor and the procuring activity. Nonlinearities or higher-order dynamics that may exist shall not result in any objectionable (for Levels 1 and 2) or dangerous characteristics.

REQUIREMENT RATIONALE (4.1.10)

Where higher-order effects are involved, consideration of any particular roots can be misleading. In acknowledgment of the increasing complexity of aircraft control systems, equivalent system approximations to aircraft response characteristics are then required for comparison with the quantitative requirements.

REQUIREMENT GUIDANCE

The related MIL-F-8785C paragraph is 3.1.12.

The background information and user guide (BIUG) for that document, AFWAL-TR-81-3109, discusses the rationale behind this requirement very succinctly, as follows:

In the past, both operational experience and flying qualities research were largely limited to aircraft which behaved in the classical manner: response to control and disturbance inputs characterized by transfer functions of familiar form. The effects of additional dynamics introduced through the flight control system were recognized at the time MIL-F-8785B was written, but limited knowledge prevented adequate treatment. Still, aircraft design developments continue to emphasize equalization to "improve" aircraft response. In Systems Technology, Inc. TR-190-1, Stapleford discusses both good and bad possibilities. Certainly one would expect that failure to consider one or more dynamic modes in the frequency range of pilot control would give erroneous results. Prime examples include the F-14 (AGARD-CP-119) and the YF-17 (AIAA Paper 75-985) designs. The F-14's stability augmentation system was designed to increase the low short-period frequency. At one stage it did that well in landing approach, but it also introduced higher-order dynamics which resulted in an overall effective short-period frequency little changed from augmentation-off. In a flight evaluation of predicted YF-17 characteristics using the AFWAL-Calspan NT-33 Variable Stability Airplane, pilots rated the short-period response poor to bad. The equivalent system approach may not have been used to improve the response. However, it is pertinent that a configuration intended to have good flying qualities got good pilot ratings in flight only after the flight control system compensation had been simplified.

Boothe, et al. (AFFDL-TR-74-9) suggest several simple mechanizations that augment stability without increasing the order of the system response. Nevertheless prefilters, forward-loop compensation, crossfeeds, etc., are legitimate design tools that are being used on many current aircraft and indeed seem to be the norm. These artifacts do increase system order and we need to be able to account for their effects in the requirements. Thus, with modern flight control and stability augmentation systems, there is considerable confusion regarding the proper selection of modal parameters such as short-period frequency and damping. Correlation of Level 1 flying qualities with characteristics of the bare airframe is certainly not valid for augmented aircraft in general. Stability and control augmentation frequently introduce additional dynamics in the frequency range of pilot control, thereby invalidating any interpretation of the requirements in terms

MIL-STD-1797A
APPENDIX A

of particular roots of a transfer function. Although these fallacies have been pointed out many times, misinterpretations continue. The feeling is not uncommon that some requirements just do not apply. This paragraph, 4.1.10, is intended to clarify application of the requirements to flying qualities in general.

In reality, we are only interested in pilots' opinions as to whether the actual aircraft dynamics enable the appropriate tasks to be performed well enough with acceptable workload. We now require, therefore, that the actual dynamics be approximated by the responses of transfer functions of classical form. The appropriate parameters of this equivalent transfer function must meet the modal requirements of the standard. This so-called equivalent system approach allows continued use of the familiar test data base for a broad range of mechanizations. It has been advocated strongly by Hodgkinson and others (Systems Technology, Inc. TR-190-1, AIAA Paper 77-1122, AIAA Paper 80-1627-CP, and Hodgkinson, Berger, and Bear).

The preceding discussion should not be taken to imply that there is little problem with applying the specification requirements to equivalent system parameters. For configurations which exhibit conventional-appearing dynamics, application is indeed straightforward. It also appears to be true at present that pilots are most comfortable with response dynamics that are natural, that is, like the classical modes. Certainly, additional prominent modes result in a more complicated dynamic response. As we consider configurations with dynamics that depart more and more from the classical order or form, then more and more judgment will be required in defining the appropriate equivalent system parameters and assessing compliance with the requirements. Hodgkinson has suggested that flying qualities will be poor if no equivalent system can be found to give a good fit to the actual response. Although success of the equivalent system approach in applying or defining the Level 2 and 3 boundaries is not definite at this time, such application appears sufficient though possibly not necessary to achieve the desired goals.

There are also questions which remain to be answered. Is the equivalent system solution unique? (Not universally, it seems.) Can the equivalent system parameters be juggled until compliance is indicated? (In limited observations, some tendency toward equivalent results from different techniques has been noted.) Are requirements necessary for either the amount or the quality of the mismatch? (To date this has not been a major problem.) In spite of the qualifying remarks and the above questions, this approach is a way to apply known requirements to advanced configurations with high-order dynamic responses. We preserve the validated data base of MIL-F-8785B/C and the experience in its use. At the same time the equivalent systems are to be defined by matching an appropriate aircraft response to pilot control input. We therefore focus attention on the quality of the actual overall response perceived by the pilot, rather than to imply consideration of a dominant mode as may be inferred (however incorrectly) from MIL-F-8785B. We also believe that the use of the equivalent system approach is responsive to the needs of designers. Failure of an equivalent system parameter to meet the requirement then indicates the characteristic of the actual system (e.g., bandwidth, peak amplification, phase lag) that must be improved. We acknowledge that the use of equivalent systems is not a magic solution to good flying qualities; however, properly used it is a good tool for designing or evaluating advanced configurations which are becoming indiscriminately complex.

In order to demonstrate compliance with the modal requirements of MIL-F-8785C, equivalent systems must first be defined to approximate the actual aircraft dynamics whether predicted analytically or obtained from flight test. Considerations for specific axes are discussed elsewhere following the appropriate requirement. In general, however, it is necessary to add a term representing a time delay to the "classical form" of the response. This term, itself a specified parameter (4.2.1.2, 4.5.1.5), allows a closer match of the higher-frequency content of most advanced systems considered to date. The time delay has been correlated with pilot opinion ratings.

The requirement as written is intended to allow the contractor to use any reasonable method of determining the equivalent aircraft systems. However, the procuring activity may require some particular method for final compliance demonstration. Guidance for some of the individual requirements contains more detail.

MIL-STD-1797A
APPENDIX A

Other forms of dynamic requirements, such as time to bank, apply to the actual system, whatever its order or nonlinearity. It is only the transfer-function parameters that are to be equivalent; whereas the specified responses are generally those of the entire, actual system.

REQUIREMENT LESSONS LEARNED

In AFWAL-TR-82-3064, Powers notes that the large separation of short-period frequency and pitch-numerator inverse time constant makes the pitch transfer function for control inputs difficult to match with the standard equivalent system. Whether this indicates a problem with equivalent systems or a flying qualities deficiency is hard to determine. We do note that for low speed (with less separation of those roots) NLR-TR-79127U reports rating degradation with the large pitch overshoot which results from the separation. Some other requirements are suggested in this handbook for use when the equivalent system approach is not satisfactory.

Hodgkinson and Bischoff (separately) discuss equivalent systems in AFWAL-TR-82-3064. AFWAL-TR-81-3118 lists generally good matches of longitudinal short-term dynamics of some unstable aerodynamic configurations stabilized by pitch rate feedback and forward-loop integration; pilot distance from the center of gravity was found to be a complicating factor.

5.1.10 Interpretation of quantitative requirements-verification.

Verification shall be by analysis, simulation and test.

VERIFICATION RATIONALE (5.1.10)

Either frequency-response or time-response methods can be used (see Appendix B) to identify the equivalent-system parameters. Appendix B outlines a procedure for matching the higher-order frequency, response, however obtained. Frequency-response matching is preferred because it assures the best match over the range of pilots' control-input frequencies in the closed-loop tasks of primary interest.

VERIFICATION GUIDANCE

Appendix B discusses matching techniques and a computer program for performing the match. Flight measurement techniques for frequency response data are discussed in 5.2.1.2.

VERIFICATION LESSONS LEARNED

MIL-STD-1797A
APPENDIX A

4.1.11 General flying qualities requirements

4.1.11.1 Buffet.

Within the boundaries of the Operational Flight Envelope, there shall be no objectionable buffet which might detract from the effectiveness of the aircraft in executing its intended missions. In the Permissible Flight Envelope _____.

REQUIREMENT RATIONALE (4.1.11.1)

The intent of this requirement is to prevent the occurrence of objectionable levels of buffet in the course of operational flight.

REQUIREMENT GUIDANCE

The related MIL-F-8785C requirement is paragraph 3.4.5.

"Objectionable" is to be interpreted in the context of operational missions: an annoyance, distraction or discomfort; or an interference with maneuvering or tracking. For a combat aircraft the procuring activity may need to extend the requirement to apply throughout the Permissible Flight Envelope. The extension would apply, for example, to an air combat fighter intended to have high-angle-of-attack capability and to a trainer for spinning.

Clearly, in those cases where buffet is a signal to the pilot of approach to a dangerous flight condition (4.1.8.1) some buffet is desirable--but there should be no need for that within the Operational Flight Envelope. AGARD-AR-82 contains a concise discussion on buffet and offers some guidelines on the acceptability of various buffet levels:

To the fighter pilot who knows his aircraft, buffet onset is a valuable source of information in moments of intense activity when he is not able to refer to his flight instruments. Of the many different buffet level criteria to be found ... the following is a summary which smoothes out the variations. The "g" values quoted are maximum excursions about trim:

Onset	+ .035 to .1 g _z	perception depends on workload/normal g
Light	+ .1 to .2 g _z	definitely perceptible
Moderate	+ .2 to .6 g _z	annoying
Severe	+ .6 to 1.0 g _z	intolerable for more than a few seconds

Provided that there are no other effects such as loss of full control or random aircraft motions, light buffet usually had no adverse effect on maneuvering, either coarsely or precisely. The average fighter pilot is so used to flying in this region that he may not even comment on it at the lower amplitudes. He will however feel annoyance and frustration when the buffet characteristics reach the level where his ability to track his target is affected, other effects on his performance may result from the arm mass feedback to the stick and his ability to see the target on his cockpit controls and instruments. At the intolerable level the motion becomes physically punishing, and full control is not possible as a result of the effect of the buffet on the pilot himself.

The significance of buffet in air combat depends upon the task. If flight in buffet gives a performance improvement then pilots will use this region during the tactical phase of combat. Tracking will also take place at quite high buffet levels, even with guns; but when the low frequency, high amplitude "bouncing" buffet occurs then there is no further advantage to be gained from operating in this region.

MIL-STD-1797A
APPENDIX A

REQUIREMENT LESSONS LEARNED

5.1.11 General flying qualities-verification

5.1.11.1 Buffet-verification.

Verification shall be by analysis, simulation and test.

VERIFICATION RATIONALE (5.1.11.1)

Flight testing at elevated angles of attack and load factors, and at lower angles transonically, will reveal any buffeting tendencies. A windup turn maneuver while tracking a target can be especially useful in identifying buffet regions. In flight, wing buffet intensity rise can be measured with a wingtip accelerometer. Figure 9 illustrates methods of determining the region of buffet intensity rise from (a) normalized rms values of wingtip normal acceleration and (b) estimations based on time history data.

VERIFICATION GUIDANCE

Wind-tunnel tests can give early indication of buffet onset and intensity, but flight testing will be needed to determine the end effect with structural vibrations, noise, etc. included.

VERIFICATION LESSONS LEARNED

Judgment seems to be subjective, so marginal or critical cases should be evaluated by a number of pilots

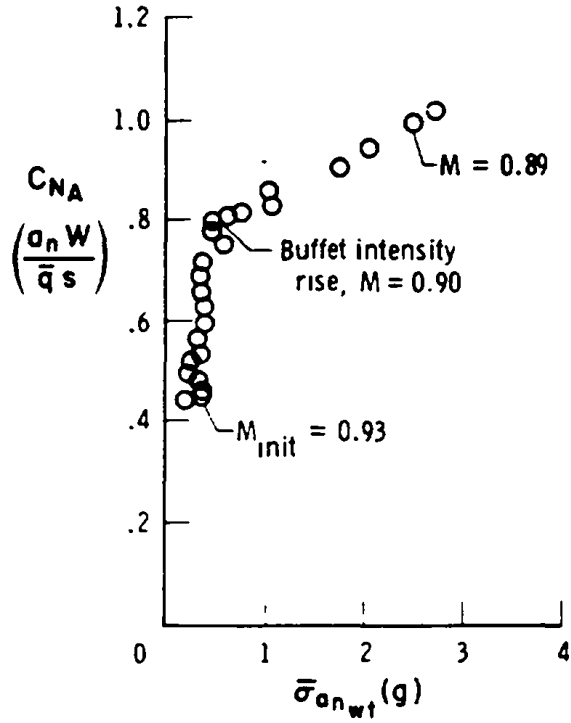

a) Normalized RMS Values of Wingtip Normal Acceleration

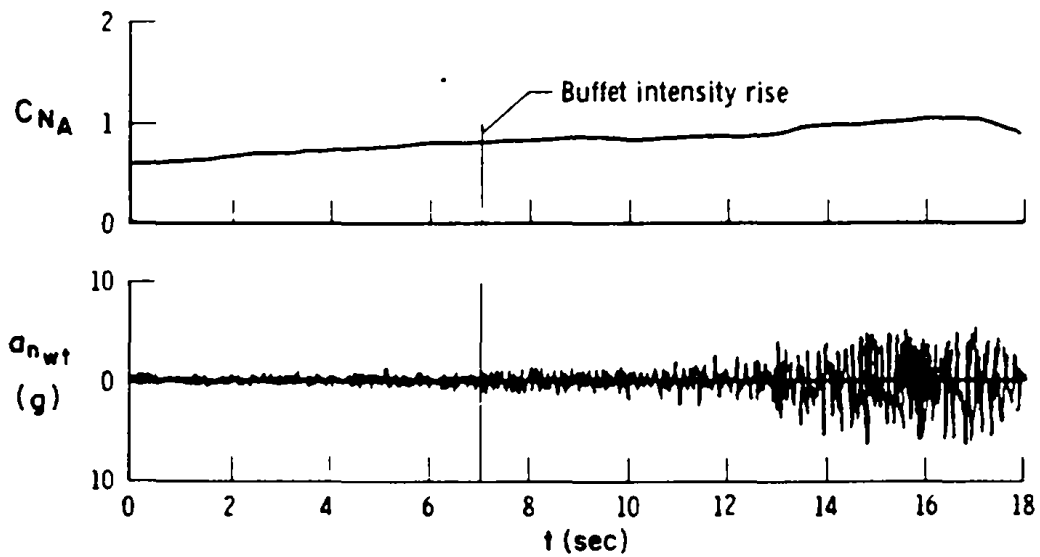

b) Time History of Wingtip Acceleration

FIGURE 9. Buffet intensity rise determination from NASA-TP-1368.

MIL-STD-1797A
APPENDIX A

4.1.11.2 Release of stores.

The intentional release or ejection of any stores shall not result in objectionable flight characteristics or impair tactical effectiveness of Levels 1 and 2. However, the intentional release or ejection of stores shall never result in dangerous or intolerable flight characteristics. This requirement applies for all flight conditions and store loadings at which normal or emergency release or ejection of the store is permissible.

REQUIREMENT RATIONALE (4.1.11.2)

This requirement is included to insure that stores release will not have an adverse effect on flying qualities.

REQUIREMENT GUIDANCE

The related MIL-F-8785C requirements are paragraphs 3.4.6 and 3.3.4.1.2.

Because of the variety of possibilities, this requirement must be left qualitative. All store loadings, internal and external, which are specified in the contract are covered.

See MIL-HDBK-244 for additional requirements and guidance.

REQUIREMENT LESSONS LEARNED

5.1.11.2 Release of stores-verification.

Verification shall be by analysis, simulation and test.

VERIFICATION RATIONALE (5.1.11.2)

Evaluation of this criterion shall occur as a natural part of operational flight testing, usually preceded by analysis (.e.g, AFFDL-TR-74-130 and AFWAL-TR-80-3032) and wind-tunnel testing. The wind-tunnel tests may be guided on-line by trajectory calculations using a combination of currently-generated and stored data.

There may be special flight envelopes in which store release or missile firing are permitted. Generally such envelopes are ultimately cleared by flight testing.

VERIFICATION GUIDANCE

Store motion after release is such a function of the local airflow field that few generalities can be made about the most critical conditions. At the same angle of attack the aerodynamic forces are greater at higher speed. Dive angle, normal acceleration, store location, and store and ejector configuration and loading are important to consider. The critical conditions will likely be at the boundaries of the release envelopes.

VERIFICATION LESSONS LEARNED

MIL-STD-1797A
APPENDIX A

4.1.11.3 Effects of armament delivery and special equipment.

Operation of movable parts, such as bomb bay doors, cargo doors, armament pods, refueling devices and rescue equipment, or firing of weapons, release of bombs, or delivery or pickup of cargo shall not cause buffet, trim changes, or other characteristics which impair the tactical effectiveness of the aircraft under any pertinent flight condition. These requirements shall be met for Levels 1 and 2.

REQUIREMENT RATIONALE (4.1-11.3)

This requirement is included to assure that armament delivery, etc., will not adversely affect flying qualities, impairing mission effectiveness.

REQUIREMENT GUIDANCE

The related MIL-F-8785C requirement is paragraph 3.4.7.

Because of the variety of possibilities, this requirement must be left qualitative. All armament and equipment for the design missions are covered.

REQUIREMENT LESSONS LEARNED

Gun firing can cause deceleration and, depending on lateral and vertical location, attitude transients. It has also been known to interfere with engine-inlet airflow or pilot vision. Rigidity and dynamics of local structure and items attached to it influence the aircraft vibration resulting from gun firing.

5.1.11.3 Effects of armament delivery and special equipment-verification.

Verification shall be by analysis, simulation and flight test.

VERIFICATION RATIONALE (5-1.11.3)

Operational flight test should be required, preceded by suitable analyses and wind-tunnel tests. Generally the critical conditions should thus be known before flight test.

VERIFICATION GUIDANCE

Each movable part needs to be analyzed for its effect on stability and control.

VERIFICATION LESSONS LEARNED

MIL-STD-1797A
APPENDIX A

4.1.11.4 Failures.

No single failure of any component or system shall result in dangerous or intolerable flying qualities; Special Failure States (4.1.7.2) are excepted. The crew member concerned shall be given immediate and easily interpreted indications whenever failures occur that require or limit any flight crew action or decision. The aircraft motions following sudden aircraft system or component failures shall be such that dangerous conditions can be avoided by the pilot, without requiring unusual or abnormal corrective action. A realistic time delay of at least between the failure and initiation of pilot corrective action shall be incorporated when determining compliance. This time delay shall include an interval between the occurrence of the failure and the occurrence of a cue such as acceleration, rate, displacement, or sound that will definitely indicate to the pilot that a failure has occurred, plus an additional interval which represents the time required for the pilot to diagnose the situation and initiate corrective action.

Additional requirements apply to transients from propulsion system (4.5.8.4, 4.5.9.5.5, 4.6.5.1, 4.6.6.2, 4.6.7.8) and flight control system (4.2.6.1, 4.2.8.6.5, 4.5.7.1, 4.5.9.5.6, 4.6.5.2, 4.6.7.9) failures.

REQUIREMENT RATIONALE (4.1.11.4)

These provisions involve safety of flight. In addition to accounting for flying qualities after a failure, we recognize that the transient between the normal and the failed state could result in further flying qualities degradation.

REQUIREMENT GUIDANCE

The related MIL-F-8785C requirements are paragraphs 3.4.8 and 3.4.9.

Recommended minimum time delay: A default value would be 1 second.

A minimum realistic time delay value of 1 second is consistent with Paragraph 3.3 9.3 in MIL-F-8785C. For civil operation the FAA is more conservative with hardover failures of autopilot servos, requiring 3 seconds before pilot takeover is assumed. This time delay is to include an interval between the occurrence of the failure and the occurrence of a cue such as acceleration, rate, or sound that will definitely indicate to the pilot that a failure has occurred, plus an additional interval which represents the time required for the pilot to diagnose the situation and initiate corrective action. The length of time should correspond to the pilot's likely set to respond, for example longer during cruise than at takeoff.

NASA-CR-177331 or NASA-CR-177304 present guidance on determining a realistic time delay that seems as applicable to winged aircraft as it is to rotorcraft. Table IX and the paragraph following it are excerpts.

MIL-STD-1797A
APPENDIX A

TABLE IX. Summary of minimum allowable intervention times for system failures.

Phase Of Flight	Rotorcraft Response $t_1 - t_0$	Pilot Response $t_2 - t_1$	Minimum Allowable Intervention Delay Time and Method of Test
Attended Operation	Time for rotorcraft to achieve change of rate about any axis of 3 deg/sec <u>OR</u> The time to reach a change of "G" in any axis of 0.2 <u>OR</u> For an attention getter to function	1/2 sec	System failures will be injected without warning to the pilot. His ability to recover as rapidly as possible without a dangerous situation developing will be used to assess system failure mode acceptability.
Divided Attention Operation Hands On	Time for rotorcraft to achieve change of rate about any axis of 3 deg/sec	1-1/2 sec (Decision 1 plus reaction 1/2)	The pilot will be warned of the system failure. Demonstration of compliance must show that an intervention delay time equal to 1 1/2 sec + ($t_1 - t_0$) can be tolerated
Divided Attention Operation Hands On	<u>OR</u> The time to reach a change of "G" in any axis of 0.2 <u>OR</u> For an attention getter to function	2-1/2 sec (Decision 1-1/2 plus reaction 1)	As above but intervention delay time 2 1/2 seconds + ($t_1 - t_0$)
Unattended Operation Hands On	As above but the threshold rates and "G" values are 5 deg/sec and 0.25 respectively	2-1/2 sec (Decision 2 plus reaction 1/2)	As above.
Unattended Operation Hands Off		4 sec (Decision 3 plus reaction 1)	As above but intervention delay, time 4 sec + ($t_1 - t_0$)

TABLE IX. Summary of minimum allowable intervention times for system failures - Continued.

ROTORCRAFT RESPONSE TIME INTERVAL ($t_1 - t_0$). This is the period between the failure occurring and the pilot being alerted to it by a suitable cue. The cue may take the form of an adequate tactile, audio, or visual warning. (The eye cannot be relied upon to distinguish abnormal instrument indications sufficiently early for these to be regarded as an adequate cue). In the absence of the adequate cues listed above, it can be assumed that a pilot will be alerted when the rotorcraft meets or exceeds the responses listed for unattended operation.

PILOT RESPONSE TIME INTERVAL ($t_2 - t_1$). The period commences at the time the pilot is alerted to the fact that something abnormal is happening and terminates when the controls are moved to commence the recovery maneuver. The period consists of the recognition time, decision time, and reaction time. As shown above, the recognition and decision times are assumed to increase as the pilot relaxes his level of involvement, i.e., in going from "attended operation" to "unattended operation" and also in going from "hands on" to "hands off". The reaction time is longer "hands off" than "hands on" as the pilot has to locate the controls before he can move them.

Pilot response time is especially critical in defining a reasonable minimum pilot intervention delay time to a failure. The status of the pilot in the overall task of controlling the rotorcraft can be described as active or attended control operation, divided attention control operation (both hands on the controls and hands off), or unattended control operation such as in autopilot mode (both hands on and hands off the control). For example, if the pilot is making a final approach to a landing, he would be considered to be in an attended operation mode of rotorcraft control with his hands on the control. Should an automatic flight control occur, the minimum pilot response time for corrective control input following recognition of the failure would be quite small, approximately half a second. Therefore, for testing the acceptability of failures in this mode of flight, it would be unreasonable to require testing (or specification) of a minimum allowable response time any greater than 1/2 second. However, for cross country flight at cruise airspeeds, it is very possible that the pilot will not have his hands on the control if an autopilot is engaged. For failures which have a significant probability of occurrence in this flight mode, the specification of a 1/2 second pilot response time for test purposes would be unreasonable and unsafe. In this standard, therefore, the minimum allowable pilot response time would be adjusted to 2-1/2 seconds following any single failure.

A propulsion failure along with a failed automatic compensation device or flight control system failure is a consideration. A rational ground rule would be to include the probability of such combinations in the calculations for 4.1.7.3 or 4.9.1 by assuming a probability of 1 that the critical engine failure occurs, and adding any failures which result in nuisance actuation of the automatic device.

REQUIREMENT LESSONS LEARNED

Aircraft have been lost from runaway trim. That possibility needs careful consideration for every powered trim system.

MIL-STD-1797A
APPENDIX A

5.1.11.4 Failures-verification.

Verification shall be by analysis, simulation, and test.

VERIFICATION RATIONALE (5.1.11.4)

For those failures and flight conditions judged too hazardous to evaluate in flight, demonstration likely will be by simulation. Validated models of the aircraft and its flight control system will be needed for that, and adequate motion cues should be available to simulate the acceleration environment with one-to-one fidelity for at least two seconds following the failure.

VERIFICATION GUIDANCE

See table IX.

VERIFICATION LESSONS LEARNED

MIL-STD-1797A
APPENDIX A

4.1.11.5 Control margin.

Aerodynamic control power, control surface rate and hinge moment capability shall be sufficient to assure safety throughout the combined range of all attainable angles of attack (both positive and negative) and sideslip. This requirement applies to the prevention of loss of control and to recovery from any situation, including deep stall trim conditions, for all maneuvering, including pertinent effects of factors such as pilot strength, regions of control-surface-fixed instability, inertial coupling, fuel slosh, the influence of symmetric and asymmetric stores (4.1.3), stall/post-stall/spin characteristics (4.8.4 through 4.8.4.3.2), atmospheric disturbances (4.9.1) and Aircraft Failure States (4.1.7 through 4.1.7.6; failures transients and maneuvering flight appropriate to the Failure State are to be included). Consideration shall be taken of the degree of effectiveness and certainty of operation of limiters, c.g. control malfunction or mismanagement, and transients from failures in the propulsion, flight control and other relevant systems. Additionally, for all failure states and flight conditions, control margins shall be such that control can be maintained long enough to fly out of atmospheric disturbances, all Flight Phases can be terminated safely, and a waveoff (go-around) can be accomplished successfully.

REQUIREMENT RATIONALE (4.1.11.5)

This overall requirement is intended to assure adequate control for safety in any situation not otherwise covered in the Standard. It is intended to permit recovery from unusual situations in, and even beyond, the Permissible Flight Envelope--on the grounds that if a condition is attainable, someday it will be attained. Experience has shown that to be a reasonable assumption.

REQUIREMENT GUIDANCE

The related MIL-F-8785C paragraph is 3.4.10.

To attain performance benefits, we no longer require control-surface-fixed stability. Whatever the cause, control saturation can be catastrophic in a basically unstable airframe. Then control deflection for recovery, whether commanded by the pilot or automatically, is just not available. This differs from the stable case, in which if the deflection limit is reached for trim, full control authority is available for recovery. Control rate limiting can also induce instability if the basic airframe is unstable. This requirement, together with the related changes mentioned, is intended to require full consideration of all the implications of relaxed static instability and other Control-Configured Vehicle (CCV) concepts.

In considering how much margin of control should be required there is no general quantitative answer, but it is possible to enumerate some cases to consider. Certainly there should be sufficient control authority to pitch the aircraft out of any trim point to lower the angle of attack from any attainable value. That is, with full nose-down control the pitching moment should be at least a little negative at the most critical attainable angle of attack, for a center of gravity on the aft limit and nominal trim setting. Attainable angle of attack is another issue in itself; but lacking intolerable buffet or a limiter that is effective in every conceivable situation, angles to at least 90 degrees should be considered. Control margin is also necessary at negative angle of attack.

The flight task will dictate some minimum amount of nose-down control capability. Air combat maneuvering certainly imposes such a requirement, and so do terminal-area operations including landing flareout. Then, there should be some capability to counter atmospheric disturbances while maneuvering and center-of-gravity movements due to fuel slosh while accelerating, diving or climbing; stop rotation at the takeoff attitude, etc. Roll inertial coupling has been a critical factor for many slender aircraft

In addition to conventional control modes, a CCV's direct force controls can offer a number of new, possibilities ranging from independent fuselage aiming to constant-attitude landing flares. The additional variables must be accounted for to assure adequate sizing of the control surfaces, and priorities may need to be established. The effectiveness of thrust vectoring varies with airspeed and altitude, and of course with the commanded thrust level; engine flameout or stall may be a consideration.

MIL-STD-1797A
APPENDIX A

The instabilities and complications resulting from these factors can probably be rectified by stability augmentation if and only if control effectiveness is adequate. The controllability margin conventionally provided by static stability must be translated for CCV's into margins of control authority and rate. Control must be adequate for the combined tasks of trim (establishing the operating point), maneuvering, stabilization (regulation against disturbances), and handling of failures (flight control system, propulsion, etc).

4.1.12.8 precludes dangerous single failures. After the first failure it may be advisable to constrict flight envelopes for some assurance of flight safety in case, say a second hydraulic system should fail. The procuring activity will need to weigh the expected frequency and operational consequences of such measures against predicted benefits.

Excessive stability, as well as excessive instability of the basic airframe, is of concern with respect to available control authority and rate; for example large stable $C_{\ell\beta}$, increases the roll control power needed to counteract gusts.

The requirements of this paragraph are largely an emphasis or amplification of other requirements in this standard, among them:

- 4.1.1 Loadings
- 4.1.3 External stores
- 4.1.6.2 Flight outside the Service Flight Envelope
- 4.1.11.4 Failures
- 4.1.12.7 Transfer to alternate control modes
- 4.2.5 Pitch trim changes
- 4.2.7 Pitch axis control power
- 4.5.8 Roll axis control power
- 4.6.5.1 Yaw axis response to asymmetric thrust
- 4.6.6 Yaw axis control power
- 4.8.1 Cross-axis coupling in roll maneuvers
- 4.8.4 Flight at high angle of attack
- 4.9 Flying quality requirements in atmospheric disturbances

REQUIREMENT LESSONS LEARNED

It is well known that hinge moments can limit both deflection and rate of control surfaces. When using a surface for control in two axes, as with a horizontal stabilizer deflected symmetrically for pitching and differentially for rolling, priorities or combined limits must be set to assure safety (AIAA Paper 78-1500). Other demands on the hydraulic system can reduce control capability at times. Aeroelasticity can reduce control effectiveness directly, as well as alter the aircraft stability. For the F-16, full nose-down control put in by stability augmentation has to be overridden in order to rock out of a locked-in deep stall. Also, aerodynamics sometimes have to remind control analysts that control surfaces themselves stall at an incidence somewhat less than 90 degrees; and if control is supplemented by thrust vectoring, for example,

MIL-STD-1797A
APPENDIX A

one must consider the control force or moment available in normal operation, the effect on forward thrust, and the possibility of flameout, as well as aerodynamic interference effects. All the possible interactions of active control must be taken into account.

Encountering the wake vortex of another aircraft can be an extremely upsetting experience. These encounters are not uncommon in practice or real air combat, and also may occur in the terminal area and elsewhere; prediction is difficult. Other atmospheric disturbances can be severe, too: jet streams, storms, wakes of buildings, etc., as well as gusts and wind shear.

The amount of control capability at extreme angles of attack, positive and negative, must be enough to recover from situations that are not otherwise catastrophic. Avoidance of a locked-in deep stall has been known to limit the allowable relaxation of static stability. Also, control must be sufficient to counter the worst dynamic pitch-up tendency below stall or limit angle of attack. Propulsion and flight control system failure transients must be considered, along with possibly degraded control authority and rate after failure: spin/post-stall gyration susceptibility and characteristics may well be affected. Fuel system failure or mismanagement must be allowed for.

The range of maneuvers considered should account for both the stress of combat and the range of proficiency of service pilots. For example, in 1919 the British traced a number of losses of unstable airplanes to control authority insufficient to complete a loop that had got flattened on top (ARC R&M No. 917). Thus nose-up capability at negative angles of attack can also be important. Poorly executed maneuvers may make greater demands on the flight control system for departure prevention or recovery. For CCVs as well as conventional aircraft, limiters can help greatly but their effectiveness and certainty of operation need to be considered. Spins attained in the F-15 and F-16 attest to the possibility of defeating limiters. AFWAL-TR-81-3116 describes the A-7 departure boundary's closing in with increasing sideslip angle; angular rates also affect departure boundaries. Rapid rolling sometimes creates inertial coupling which can put great demands on pitch control; nose-down pitching seems to accentuate the divergence tendency.

External stores change both center of gravity and pitch moment (C_{m_0} and C_{m_α}). Experience with past aircraft indicates a firm need to allow some margin to account for unforeseen store loadings. With relaxed static stability this can determine not only the safety, but the possibility of flight with stores not considered in the design process.

Uncertainties exist in the design stage. Nonlinear aerodynamics, particularly hard to predict even from wind-tunnel tests, are almost certain to determine the critical conditions. The center of gravity (c.g.), too, may not come out as desired. And in service the c.g. location is only known with limited accuracy. There are also possible malfunctions and mismanagement in fuel usage to consider. We have even seen recent cases (e.g., F-111 and F-16) of misleading wind-tunnel results on basic static stability. Aeroelasticity and dynamic control effectiveness (e.g., F-15) can also reduce control margins.

Asymmetric loadings need to be considered. A critical case for the L-19 was the addition of a wire-laying mission involving carriage of a large reel under one wing. Some aircraft - the F-15 is a recent example - have been prone to develop significant fuel asymmetries due to prolonged, inadvertent small sideslipping. Dive pullouts ($n > 1$) will accentuate the effects of loading asymmetries. Some F-100s were lost from asymmetric operation of leading-edge slats (nonpowered, aerodynamically operated on their own, without pilot action), in dive-bombing pullouts.

Reconfigurable flight control systems add a new dimension to tracking and managing the available control power.

The control margin requirements must be met with aerodynamic control power only, without the use of other effectors such as thrust vectoring. This approach was chosen because experience to date with current

MIL-STD-1797A
APPENDIX A

technology inlets and engines operating at the distortion levels typical of high angle of attack at low speed dictates caution, due to the considerable uncertainty about reliability and dependability for use to stabilize and control the vehicle. Throttle usage is also a factor. While this requirement does not preclude the application of thrust vectoring for low-speed agility and super maneuverability performance enhancements in the future, it does reinforce the position that current technology engines/inlets should not be relied upon as the only means to assure flight safety, prevent loss of control or provide recovery capability anywhere in the flight envelope. Should future technology advancements provide demonstrated engine/inlet reliability at low speeds and high angles of attack, the procuring activity may allow this requirement to be modified for multiple engine aircraft such that thrust vectoring from one engine out may be used to meet it.

5.1.11.5 Control margin-verification.

Verification shall be by analysis, simulation and ground and flight test.

VERIFICATION RATIONALE (5.1.11.5)

This is a flight safety item. Analysis and simulation should precede or accompany careful buildup to suspected critical flight conditions.

VERIFICATION GUIDANCE

We do not intend through flight demonstration in dangerous cases to show compliance with this requirement. "The combined range of all attainable angles of attack and sideslip" may even extend beyond the Permissible Flight Envelope, except for certain highly maneuverable fighter and trainer aircraft. Flight test bounds will be established according to such requirements as MIL-S-83691. For extreme flight conditions a combination of model testing--wind-tunnel, free-flight if necessary, and hardware--and analysis will often be adequate. These extremes should be investigated in some way, whether or not the aircraft incorporates a limiter. The scope of analysis, simulation and testing needs careful consideration at the outset of a program. Then the progress must be monitored for possible additional troubles.

AFWAL-TR-87-3018 gives guidance on determining control deflection and rate margins and calculating the deflection-saturated departure boundary in the conceptual and preliminary design stages, based on a reduced-order system with full state feedback. At high speed and high dynamic pressure, the system bandwidth required is high, increasing the importance of high-frequency control-system modes, structural modes and system noise amplification. At low speed and low dynamic pressure, design risks are related to the limited ability of aerodynamic control surfaces to generate control moments. The lack of stabilizing control moments beyond some angle of attack, or control-surface rate limits, will compromise transient responsiveness. Describing-function analysis treats control limiting as a gain reduction, which in general lessens the stabilizing effect of feedbacks. Statistically-based margins for gusts reduce, but do not eliminate, the possibility of inadequate control margin.

Figure 10 indicates some critical parameters in the response of an unstable system to a step command. Factors influencing some control-margin increments may be seen in table X. To these margins must be added another nose-down control increment to counter the pitch-out tendency while rolling about the x stability axis (flight path). As a first cut,

$$\left| \Delta\delta \right| = \left| \frac{I_x - I_z}{2M_\delta I_y} \cdot p^2 \cdot \sin 2\alpha \right| , \quad \left| \dot{\delta} \right| = \left| \frac{I_x - I_z}{M_\delta I_y} \cdot p \cdot \dot{p} \cdot \sin 2\alpha \right|$$

where p is the stability-axis roll rate (about the flight path). Figure 11 shows in concept the margins that are needed: $\Delta\delta_{\text{marg}}$ is the sum of turbulence and sensor-noise components, $\Delta\delta_{\text{tran}}$ provides the pitching acceleration to meet the CAP requirement, and $\Delta\delta_{\text{pr}}$ can cancel the inertial pitching moment from rolling.

MIL-STD-1797A
APPENDIX A

Unless deactivated whenever saturation is encountered, an integrator in the flight control system tends to run away, leading to loss of control.

Similar considerations, also treated in AFWAL-TR-87-3018, apply to any basic airframe having static directional instability.

VERIFICATION LESSONS LEARNED

While flight-test risk must be bounded, it is necessary to assure by some means that any dangerous conditions are found and evaluated before service pilots and aircraft are lost through surprise encounters, with no known avoidance or recovery technique. Flight experience can be summarized by Murphy's Law. Therefore, it is better for highly skilled flight test pilots to find any serious glitches under controlled conditions rather than to wait for some less experienced operational pilots to find them in service use.

During F/A-18 high α /stall testing, an α hang-up phenomenon was observed (at 50-60 deg α), which was very similar to that described in 4.8.4.2.3 Lessons Learned with regard to the F-16 deep stall. At operational aft c.g.s and high α , delayed recoveries were experienced in the F/A-18 due to weak nose-down pitch restoring moments, even with full forward stick. Based upon F/A-18 test experience a pitch restoring moment coefficient (C_m) of at least -0.2 should be available for the most longitudinally unstable loading/aft c.g. combination expected to exist on Class IV aircraft. Analysis of F/A-18 test data from high α post-stall gyrations shows that the α hang-up phenomenon was further aggravated by uncommanded roll rate and yaw rate oscillations and resultant nose-up pitching moments. Flight test results indicate that these oscillations could generate pitching moments equivalent to approximately +0.1 ΔC_m , which significantly opposed natural aerodynamic pitch restoring moments. Occasionally, F/A-18 recoveries from high AOA hang-ups were significantly delayed because of accompanying roll/yaw rate oscillations when c.g./loading/AOA conditions caused C_m (full nose down control input) to be less than approximately -0.2. This suggests that for Class IV aircraft, a pitch recovery criterion could be that the pitch recovery control produce a net pitch restoring moment of not less than -0.1 (approximately 15-20 deg/sec² at low airspeed).

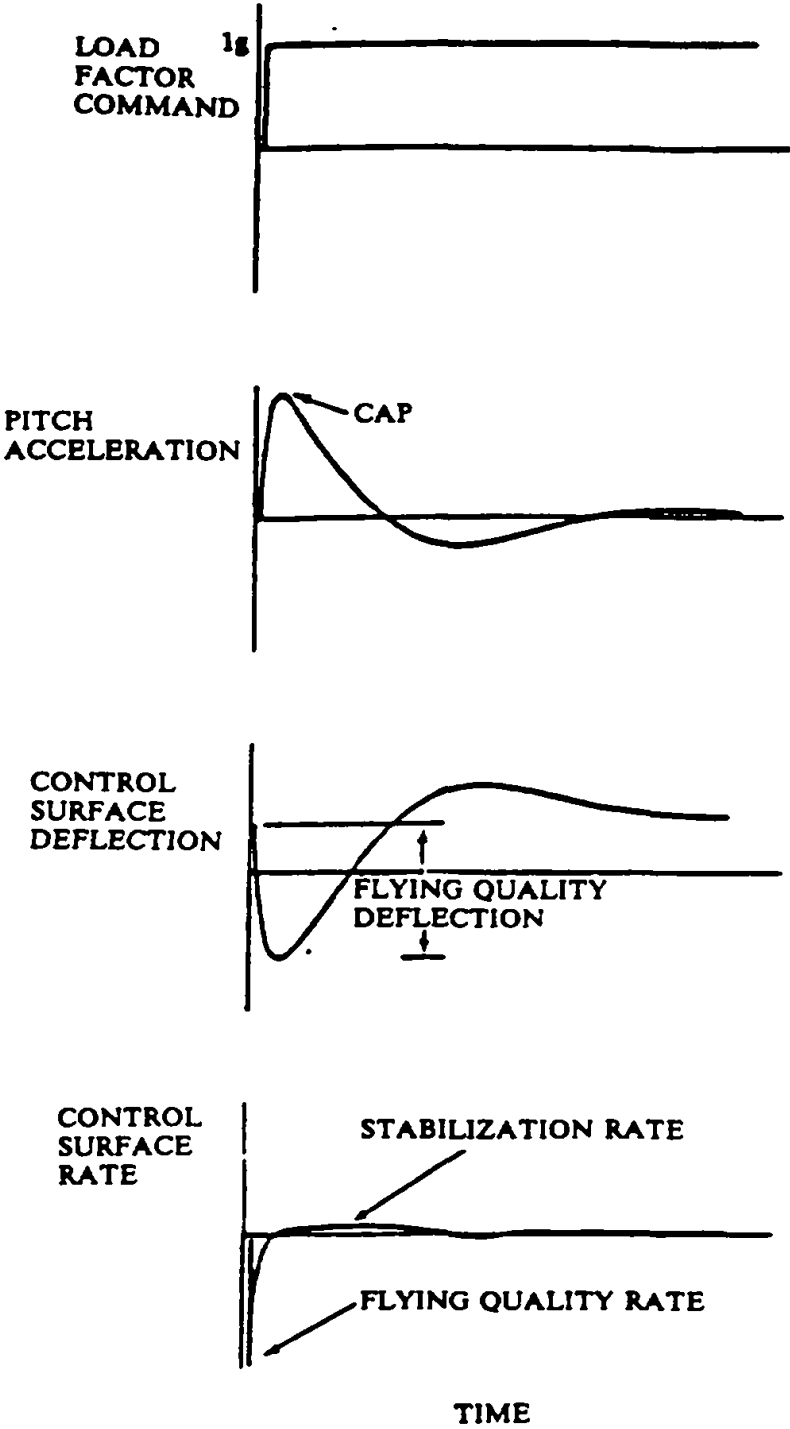

FIGURE 10. Control surface requirements.

MIL-STD-1797A
APPENDIX A

TABLE X. Control-margin increments.

Flying Quality	$\Delta\delta_{FQ}/\Delta n_c = 57.3 \text{ CAP}'/M_\delta \text{ deg/g (for } T_{\text{eff}} \leq 0.05)$
Stabilization	$\Delta\delta_{\text{stab}} / \Delta n_c = 57.3 \frac{g}{U_0} \cdot \frac{1/T_{\text{sp}_1} \cdot 1/T_{\text{sp}_2}}{M_\delta \cdot 1/T_{\theta_2}} \text{ deg/g (linear, 2DOF)}$
Turbulence	σ_δ/σ_w function of $M_w, M_\delta, \omega_{\text{sp}_{cl}}, \zeta_{\text{sp}_{cl}}$, structural modes - most severe at low \bar{q} - $3\sigma_\delta$ and σ_w for severe turbulence recommended
Sensor noise	σ_δ/σ_s function of $K_s, K_F, \omega_s, 1/T_a, \omega_{\text{sp}_{cl}}, \zeta_{\text{sp}_{cl}}, \omega_{\text{sp}_{ol}}^2$
Flying Quality	$\dot{\delta}_{FQ}/n_c = 57.3 \text{ CAP}'/(M_\delta \cdot T_{\text{eff}})$ for desired CAP
Stabilization	$\dot{\delta}_{\text{stab}}/n_c < \dot{\delta}_{FQ}/n_c$ if FCS stability margins OK & $1/T_{\text{eff}} > \omega_c$ $\dot{\delta}_{\text{stab}}/n_c$ function of $1/T_{\text{eff}}, 1/T_{\text{sp}_2}, \omega_{\text{sp}_{cl}}, \zeta_{\text{sp}_{cl}}$
Turbulence	σ_δ/σ_w function of $1/T_a, \omega_{\text{sp}_{cl}}, \zeta_{\text{sp}_{cl}}, M_\delta$ - most severe at low \bar{q} - $3\sigma_\delta$ recommended for control margin
Sensor noise	$\sigma_\delta/\sigma_s = K_s K_F \cdot \text{fn}(\omega_s, 1/T_a \text{ and, for low } \omega_{\text{sp}_{cl}}: \omega_{\text{sp}_{ol}}^2, \omega_{\text{sp}_{cl}}, \zeta_{\text{sp}_{cl}})$ - these parameters are not all independent - $3\sigma_\delta$ recommended for control margin

Δn_c is the commanded increment of normal acceleration

$1/T_2$ is the unstable pole of the transfer function (negative; 1/sec)

$\omega_{\text{sp}_{ol}}^2$ is the 2-deg-of-freedom product of the poles, 1/sec²

$\omega_{\text{sp}_{cl}}$ and $\zeta_{\text{sp}_{cl}}$ are the closed-loop frequency and damping ratio of the short-period mode

CAP is $\dot{q}_0 / \Delta n_\infty$, CAP' is $\dot{q}_{\text{max}} / \Delta n_\infty$

ω_s is the sensor bandwidth

K_s, K_F are the sensor and forward-loop gains

σ_s, σ_w are the rms intensities of sensor noise and vertical gusts

ω_c is the crossover frequency of the $\dot{\delta}/n_c$ transfer function

T_{eff} is the effective time constant of command-path plus forward-path control-loop elements (such as prefilters and actuators)

T_a is the time constant of the actuator ram

MIL-STD-1797A
APPENDIX A

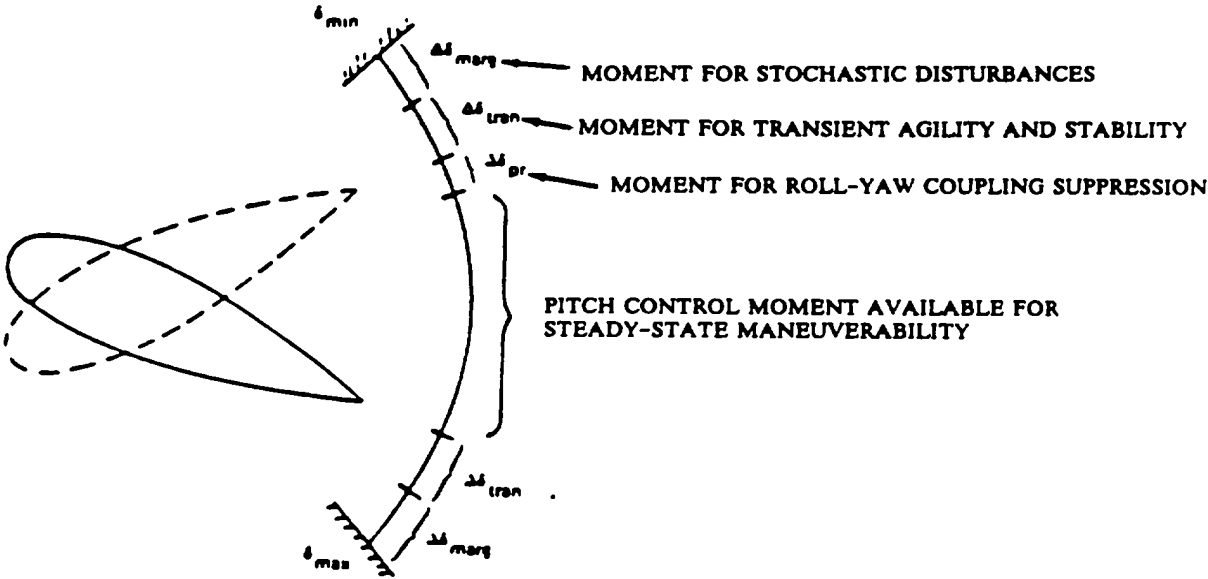

FIGURE 11. Control margin requirements.

MIL-STD-1797A
APPENDIX A

4.1.11.6 Pilot-induced oscillations (PIO).

There shall be no tendency for pilot induced oscillations, that is, sustained or uncontrollable oscillations resulting from efforts of the pilot to control the aircraft. More specific requirements are in 4.2.1.2, 4.2.2, 4.5.2 and 4.6.3. REQUIREMENT RATIONALE (4.1.11.6)

This general qualitative requirement, applicable to all axes, covers those axes of control for which there is no database for more specific requirements.

REQUIREMENTS GUIDANCE

The applicable MIL-F-8785C requirements are paragraphs 3.2.2.3 and 3.3.3.

PIOs were a consideration in setting the boundaries of 4.2.1.2 and 4.5.1.3 through 4.5.1.5.

REQUIREMENT LESSONS LEARNED

Likely causes are equivalent time delay, control system friction, or inappropriately-located zeros of aircraft transfer functions. See the discussion under 4.2.2 NORAIR Rpt No. NOR-64-143 discusses a number of possible PIO mechanisms.

5.1.11.6 Pilot-induced oscillations (PIO)-verification.

Verification shall be by analysis, simulation and flight test.

VERIFICATION RATIONALE (5.1.11-6)

Tight tracking asks, aggressively performed, will be critical, Figure 12 describe, a PIO rating procedure similar to the Cooper-Harper procedure of figure 6. Comparing the Level and rating descriptions, roughly a PIO rating of 1 or 2 would be level 1, a 3 or 4 PIO rating level 2, a 5 PIO rating Level 3, and of course a 6 PIO rating extremely dangerous.

VERIFICATION GUIDANCE

Pilot-vehicle analysis in the manner described in the discussions of the cited paragraphs should help in the design stage. Ground-based simulation may or may not show up any PIO tendencies. Flight evaluation in variable stability aircraft is a valuable tool. Final determination will come from flight test of the actual vehicle. PIOs have occurred in both pitch and roll.

VERIFICATION LESSONS LEARNED

Attention to flying qualities per se during flight control design will take care of many potential problems. PIOs may occur early in the aircraft life as on the YF-16 high speed taxi test that got airborne before its first flight, or later in service, as with the T-38 as more pilots got to fly it. If PIO is not found readily, it should be sought during the flight test program.

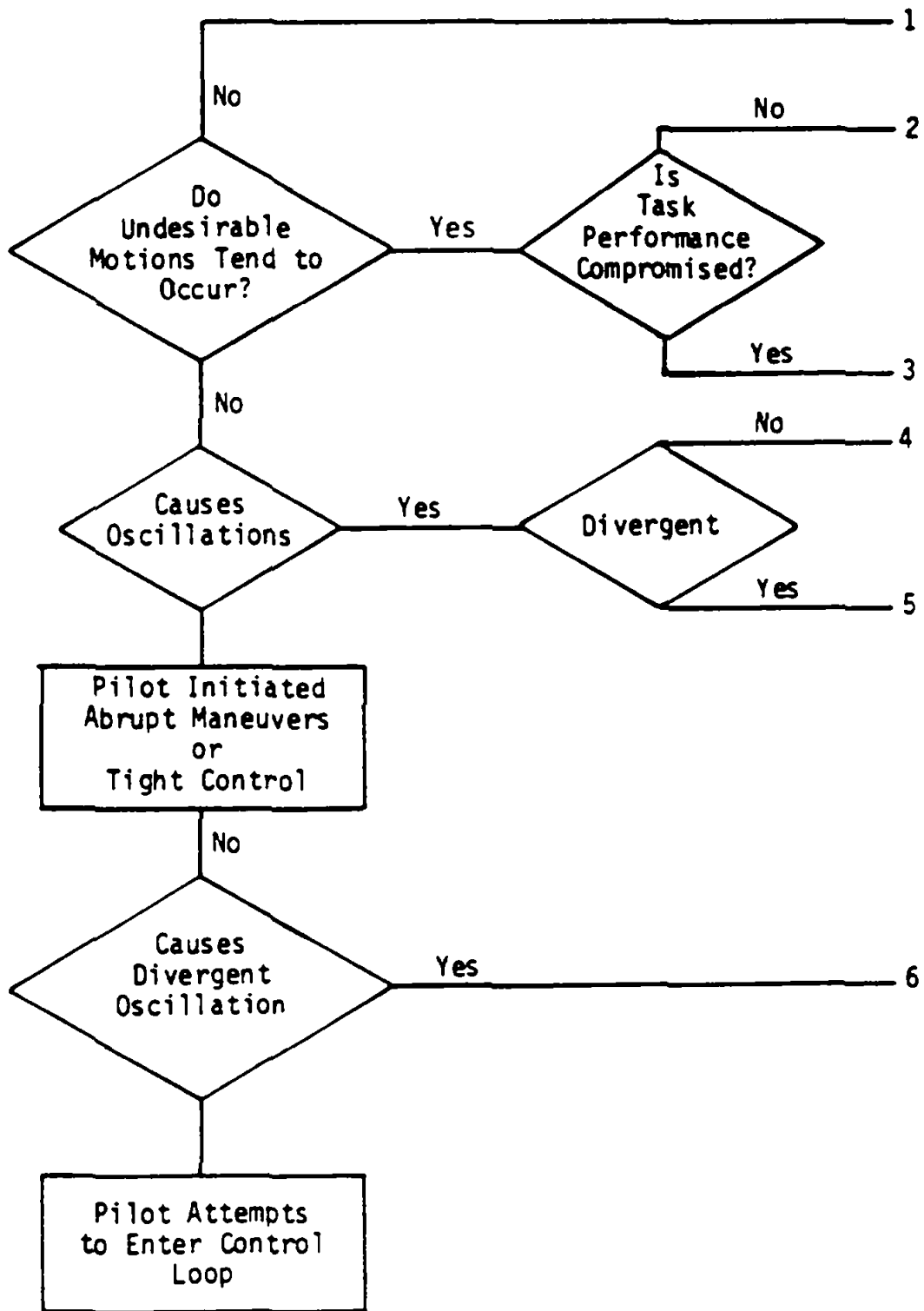

FIGURE 12. PIO tendency classification from AFWAL-TR-81-3118.

MIL-STD-1797A
APPENDIX A

4.1.11.7 Residual oscillations.

Any sustained residual oscillations in calm air shall not interfere with the pilot's ability to perform the tasks required in service use of the aircraft. More specific quantitative requirements are in 4.2.3.

REQUIREMENT RATIONALE (4.1.11.7)

This general qualitative requirement, applicable to all axes, covers those axes of control for which there is no data base for more specific requirements.

REQUIREMENT GUIDANCE

The applicable MIL-F-8785C requirements are paragraphs 3.2.2.1.3 and 3.3.1.1.

Likely causes are flight control system nonlinearities such as valve friction or, especially in unpowered flight control systems, control system friction or hinge-mounted nonlinearities.

REQUIREMENT LESSONS LEARNED

The X-29A, an unstable basic airplane, exhibits very noticeable control-surface activity during ground roll. This is a result of a compromise which keeps the stability and control augmentation active on the ground in order to assure flight safety in the event of bouncing or early lift-off.

5.1.11.7 Residual oscillations-verification.

Verification shall be by analysis, simulation and flight test.

VERIFICATION RATIONALE (5.1.11.7)

Any residual oscillations should become manifest during expansion of the flight envelope, if they have not already been discovered during ground simulations with flight hardware.

VERIFICATION GUIDANCE

Flight or ground-roll conditions with high stability-augmentation gains may be critical.

VERIFICATION LESSONS LEARNED

MIL-STD-1797A
APPENDIX A

4.1.11.8 Control cross-coupling.

No controller shall create a secondary response which is objectionable (for Levels 1 and 2) or dangerous (for Level 3). This requirement applies to all continuous and discrete controllers which affect the motion of the aircraft.

REQUIREMENT RATIONALE (4.1.11.8)

To keep from needlessly increasing pilot workload, controllers should perform their functions without deleterious side effects serious enough to cause objections for Levels 1 or 2, or a flight safety problem for Level 3.

REQUIREMENT GUIDANCE

Applicable MIL-F-8785C requirements are paragraphs 3.4.3, 3.4.11, 3.6.2, 3.6.3 and 3.6.4.

This general requirement is in addition to specific requirements, among them the ones on pilot-induced oscillations (4.1.11.6, 4.2.2, 4.5.2, 4.6.3), response to failures (4.1.11.4, 4.1.12.8, 4.2.6.1, 4.5.7.1, 4.6.5.1, 4.6.5.2, 4.6.7.9), transients and trim changes, configuration or mode changes (4.1.12.7, 4.1.13.4, 4.2.5, 4.2.6.2, 4.5.7.2, 4.5.9.5.7, 4.6.5.3, 4.6.7.10), pitch/flight path/airspeed interactions (4.2.4, 4.3.1 through 4.3.1.2, 4.4.1, 4.4.1.1), lateral acceleration response to a roll command (4.5.4), roll control in steady sideslips (4.5.5), yaw response to roll controller (4.6.2, 4.6.7.1), yaw axis control in go-around (4.6.7.7), direct side force control (4.6.1.3, 4.7.1) and other general requirements of 4.1.11 - 4.1.13. Some example applications are given below.

Operation of controllers intended for flight-path or speed control should not cause objectionable pitch response characteristics, and vice versa. (It is recognized too that some coupling in the right direction might actually be favorable. For example, a slight nose-up response to an increase in throttle would improve the short-term flight path response for STOL aircraft operating on the back side of the power-required curve; but while using the throttle for airspeed control, pitching up is the wrong direction of response to a thrust increase.)

Crossfeeds and feedbacks in the stability and control augmentation system should generally reduce the severity of trim changes, if not eliminate them; but aerodynamic cross-coupling may vary greatly with angle of attack.

"Unique Flight Characteristics of the AD-1 Oblique-Wing Research Airplane" discusses control cross coupling problems encountered on NASA's first oblique-wing airplane. In particular a pitch-roll coupling, was noted. For even a symmetric airplane, spoiler deflection for roll control may produce disconcerting pitching; spoiler deflection as a direct lift control affects drag.

REQUIREMENT LESSONS LEARNED

AIAA Paper 78-1500 recounts a B-1 design problem with its rolling/pitching horizontal stabilizer. While deflection limits can cause similar trouble, in this case limited hinge-moment capability at high speed caused a roll command effectively to command pitch motion too.

5.1.11.8 Control cross-coupling-verification.

Verification shall be by analysis, simulation and flight test.

VERIFICATION RATIONALE (5.1.11.8)

Any difficulties should become apparent during normal maneuvering plus check of failure states and control reconfigurations.

MIL-STD-1797A
APPENDIX A

VERIFICATION GUIDANCE

For the B-1 case cited, high dynamic pressure was critical. Other aerodynamic and inertial coupling is often critical at high angle of attack, low dynamic pressure.

VERIFICATION LESSONS LEARNED

4.1.12 General flight control system characteristics.

As used in this standard, the term flight control system includes the pitch, roll and yaw controls, direct force controls including leading-edge and trailing-edge flaps, stability augmentation systems, trim selectors and all mechanisms and devices that they operate, including the feel system. The requirements of this section, which are directly related to flying qualities, are in addition to the applicable control system design specification, for example MIL-F-87242 or MIL-C-18244. Some of the important mechanical characteristics of control systems (including servo valves or actuators) are: friction and preload, lost motion, flexibility, mass imbalance and inertia, nonlinear gearing, and rate limiting. Meeting separate requirements on these items, however, will not necessarily ensure that the overall system will be adequate; the mechanical characteristics must be compatible with the nonmechanical portions of the control system and with the airframe dynamic characteristics.

4.1.12.1 Control centering and breakout forces.

Pitch, roll, yaw, direct lift and sideforce controls shall exhibit positive centering in flight at any normal trim setting. Although absolute centering is not required, the combined effects of centering, breakout force, stability and force gradient shall not produce objectionable flight characteristics, such as poor precision-tracking ability, or permit large departures from trim conditions with controls free. Requirements for particular controllers are to be found in 4.2.8.5, 4.3.4, 4.5.9.4 and 4.6.7.11.

4.1.12.2 Cockpit control free play.

The free play in each cockpit control, that is, any motion of the cockpit control which does not move the control surface in flight, shall not result in objectionable flight characteristics, particularly for small-amplitude control inputs.

4.1.12.3 Adjustable controls.

When a cockpit control is adjustable for pilot physical dimensions or comfort, the control forces defined in 3.4.4 refer to the mean adjustment. A force referred to any other adjustment shall not differ by more than 10 percent from the force referred to the mean adjustment.

REQUIREMENT RATIONALE (4.1.12 through 4.1.12.3)

Customarily, flight control system specifications refer to the flying qualities requirements. The overall flying qualities requirements pertaining directly to the flight control system are placed here because of their generality. They apply to all axes of control and response.

REQUIREMENT GUIDANCE

Related MIL-F-8785C paragraphs are 3.5.1, 3.5.2, 3.5.2.1, 3.5.2.2 and 3.5.2.4. Also, see the references for 4.1.13.

Cockpit automation is becoming increasingly prominent. We are not yet in a position, however, to give more than a little general guidance on division of duties and the interface between human and automatic control. Time lags in displays will tend, of course, to be seen as effective delays in aircraft response.

It has been suggested that the crew be used for head-up, eyes-out tasks, situation awareness and executive functions:

- mission
- tactics
- environment
- contingencies

MIL-STD-1797A
APPENDIX A

While some functions that might be automated are:

mission planning	station-keeping
monitoring	rendezvous
alerting	navigation (including air drop)
routine functions	

As exemplified by the Integrated Fire and Flight Control (IFFC) advanced development program, there are cases in which partial automation is the best task solution. In that program the HUD displayed a box, its size representing the range of operation of the IFFC system. The pilot would put this box on his air-to-air target, and IFFC would put the pipper on the target. It was found helpful to leave roll control to the pilot: he could easily track the target's bank angle, and keeping involved aided the pilot to take over quickly after any failure in the high-bandwidth IFFC system.

These general qualitative requirements result from experience. Although the trim system is part of the flight control system, for convenience special trim system requirements have been grouped separately under 4.1.13.

A discernible neutral point (or trim or equilibrium point) should always be provided in manual pitch, roll, yaw or direct lift and sideforce controllers. That is, if the pilot chooses to release a control, it should return toward a neutral or trim state. If no cues are provided, the pilot will be forced to search manually for such a trim condition. This can lead to poor maneuvering control or, in the extreme, to pilot-induced oscillations. Allowable levels of friction may prevent absolute centering; that generally is alright. Throttles, instead, generally have no feel but friction. That has been found acceptable for infrequent, trim-type usage, but would cause difficulty if continuous control were attempted about a trim point with it, for one thing, after moving the throttle the pilot has no trim-position reference.

Some small amount of free play may be desirable to prevent over sensitivity to unintended control motions. However, in normal operations, and especially in high-demand times such as turbulence penetration or air combat, free play can contribute to overcontrol, loss of accuracy and rapid pilot fatigue.

No numerical value has yet been found that appears generally adequate. The allowable free play would seem to be a function of control-deflection sensitivity (angular acceleration per inch or degree of movement) and possibly control-force sensitivity as well.

The ten percent force allowance for control adjustments is intended to assure keeping within the threshold of pilot perception.

REQUIREMENT LESSONS LEARNED

5.1.12 General flight control system characteristics-verification.

Verification shall be by analysis and flight test.

5.1.12.1 Control centering and breakout forces-verification.

Verification shall be by analysis and test. Measurement of breakout forces on the ground will ordinarily suffice in lieu of actual flight measurement, provided that qualitative agreement between ground measurement and flight observation can be established

5.1.12.2 Cockpit control free play-verification.

Verification shall be by analysis and flight test.

MIL-STD-1797A
APPENDIX A

5.1.12.3 Adjustable controls-verification.

Verification shall be by inspection.

VERIFICATION RATIONALE (5.1.12 through 5.1.12.3)

Although simulation may be helpful for design purposes, final verification shall be of the flight hardware installed in the aircraft.

VERIFICATION GUIDANCE

Compliance with qualitative requirements is to be assessed according to 4.1.9. Throughout the flight test program, pilots should note any difficulty in meeting these qualitative requirements.

Except for assessing flight characteristics, of course, these verifications generally may be performed on the ground.

Evaluation in flight should be made over the operational load factor and airspeed ranges, at the minimum and maximum operational altitudes, and especially at high speeds, where required control surface deflections are small. Operationally-oriented fine tracking will be a critical test.

VERIFICATION LESSONS LEARNED

4.1.12.4 Rate of control displacement.

The ability of the aircraft to perform the operational maneuvers required of it shall not be limited by control surface deflection rates in the atmospheric disturbances specified in 4.9.1. Control rates shall be adequate to retain stabilization and control in the Severe disturbances of those sections. For powered or boosted controls, the effect of engine speed and the duty cycle of both primary and secondary control together with the pilot control techniques shall be included when establishing compliance with this requirement.

4.1.12.5 Dynamic characteristics.

A linear or smoothly varying aircraft response to cockpit-control deflection and to control force shall be provided for all amplitudes of control input. The response of the control surfaces in flight shall not lag the cockpit-control force inputs by more than the angles specified, for frequencies equal to or less than the frequencies specified: _____.

4.1.12.6 Damping.

All control system oscillations apparent to the pilot shall be well damped, unless they are of such an amplitude, frequency and phasing that they do not result in objectionable oscillations of the cockpit controls or the airframe on the ground, during flight and in atmospheric disturbances.

4.1.12.7 Transfer to alternate control modes.

The transient motions and trim changes resulting from the intentional engagement or disengagement of any portion of the flight control system by the pilot shall be such that dangerous flying qualities never result. Allowable transients are further specified in 4.2.6.2, 4.2.8.6.6, 4.5.7.2, 4.5.9.5.7, 4.6.5.3, and 4.6.7.10.

4.1.12.8 Flight control system failures.

The following events shall not cause dangerous or intolerable flying qualities:

- a. Complete or partial loss of any function of the flight control system as a consequence of any single failure (approved Aircraft Special Failure States excepted).
- b. Failure-induced transient motions and trim changes either immediately upon failure or upon subsequent transfer to alternate modes.
- c. Configuration changes required or recommended following failure.

The crew member concerned shall be provided with immediate and easily interpreted indication whenever failures occur that require or limit any flight crew action or decision. Allowable transients are specified by axis 4.2.6.1, 4.5.7.1 and 4.6.5.2.

4.1.12.9 Augmentation systems.

Operation of stability augmentation and control augmentation systems and devices, including any performance degradation due to saturation, shall not introduce any objectionable flight or ground handling characteristics. Any performance degradation of stability and control augmentation systems due to saturation of components, rate limiting, or surface deflections, shall be only momentary, and shall not introduce any objectionable flight or ground handling characteristics. This requirement particularly applies for all Normal States and Failure States in the atmospheric disturbances of 4.9.1 and 4.9.2 and during maneuvering flight at the angle-of-attack, sideslip, and load factor limits of the Permissible Envelope. It also applies to post-stall gyrations, spins, and recoveries with all systems, such as the hydraulic and electrical systems, operating in the state that may result from the gyrations encountered.

4.1.12.10 Auxiliary dive recovery devices.

Operation of any auxiliary device intended solely for dive recovery shall always produce a positive increment of normal acceleration, but the total normal load factor shall never exceed $0.8 n_L$, controls free.

4.1.12.11 Direct force controllers.

Direct force controllers include direct lift control systems and lateral translation systems. Direct force controllers which are separate from the attitude controllers shall have a direction of operation consistent with the sense of the aircraft motion produced, by conveniently and accessibly located, comfortable to

MIL-STD-1797A
APPENDIX A

use and compatible with pilot force and motion capabilities. Transients encountered with engagement of these modes shall meet the requirements of 4.1.12.7, 4.2.6.2, and 4.6.5.3. Functions should be provided in the control system that would only allow this mode to be engaged within its design flight regime or maneuvers. When used either by themselves or in combination with other control modes, flight safety and mission effectiveness shall not be degraded. These systems shall not defeat limiters that are necessary for stable and controlled flight, or for structural considerations.

REQUIREMENT RATIONALE (4.1.12.4 through 4.1.12.1 1)

This group of flying qualities requirements pertaining directly to the flight control system applies generally, to all axes of control and response. The requirement on direct force controllers is written to ensure that operation of the controllers is simple and straightforward. When implementing these controllers it must be assumed that the pilot may elect to engage the device in the middle of a maneuver, or in conjunction with another mode.

REQUIREMENT GUIDANCE

Related MIL-F-8785C paragraphs are 3.5.2.3, 3.5.3, 3.5.3.1, 3.5.6, 3.5.5, 3.4.9, 3.5.4, and 3.6.4.

These generally qualitative requirements, like the others in 4.1.13, result from experience. Compliance with qualitative requirements is to be assessed according to 4.1.9.

Atmospheric disturbances in the form of gusts should not prevent any maneuvering in the Operational Flight Envelope. This means that no limitations should be imposed due solely to control travel. Since ability to counter gusts includes surface rate characteristics, these too are mentioned explicitly. While specific disturbances are listed, the evaluation remains somewhat qualitative. The control required for attitude regulation is in addition to that required for trim and maneuvering.

Auxiliary hydraulic devices may use up significant portions of the available hydraulic power during critical phases of the mission. For example, actuation of landing gear, flaps, slats, etc., during the landing approach when the engines are operating at relatively low power settings could drain enough hydraulic power to make it difficult for the pilot to make a safe approach, especially in turbulence. In other flight conditions with less auxiliary demand or higher engine thrust, that same hydraulic system might be more than adequate. Also, at high dynamic pressure high hinge moments may limit control-surface rate and deflection.

In precision control tasks such as landing approach and formation flying it has been observed that the pilot sometimes resorts to elevator stick pumping to achieve better precision (see AFFDL-TR-65-198, AFFDL-TR-66-2, and Boeing Report D6-10732 T/N). This technique is likely to be used when the short-period frequency is less than the minimum specified or if the phugoid is unstable, but has been observed in other conditions also. Some important maneuvers, such as correcting an offset on final approach, call for simultaneous, coordinated use of several controls.

In the Navy's experience the control surface lag requirements, which are not explicitly covered by the flight control system specification, provide additional guidance concerning the portion of the time delay which may be attributed to control surface lag. Such time delay can be an important source of pilot-induced oscillation tendencies.

4.1.12.5, if quantitative limits are desired on control surface lag, the limits from table XI are recommended. While pilots do not normally observe surface motion due to stability augmentation, the time delay between pilot input and surface movement (here expressed as a phase delay) can be disconcerting--see 4.2.2 guidance.

MIL-STD-1797A
APPENDIX A

TABLE XI. Control surface lags.

Allowable Lag, def			Control	Upper Frequency, rad/sec
Level	Category A & C Flight Phases	Category B Flight Phases	Pitch	the large of equivalent ω_{sp} and 2.0
1	15	30	Roll & Yaw	the largest of equivalent ω_d $1/T_R$ and 2.0
2	30	45		
3	60	60		

The required operational maneuvers are commensurate with the particular level of flying qualities under consideration. The maneuvers required in Level 3 operation, for example, will normally be less precise and more gradual than for Level 1 and 2 operation. In some cases this may result in lower demands on control authority and rates for Level 3 operation. Note, however, that when the handling characteristics of the aircraft are near the Level 3 limits, increased control activity may occur, even though the maneuvers are more gradual.

Another requirement on control-surface rate capability, more explicit although still qualitative, is 4.1.11 5. Whereas that requirement concerns loss of control, 4.1.12.4 applies more generally.

"Dangerous flying qualities" need to be interpreted in a rational manner, so that it applies to feasible design options. We cannot take all the danger out of flying or anything else.

The demands of various performance requirements and the rapid advancement of control system technology have resulted in the application of relaxed static stability in both the pitch and yaw axes. These systems provide excellent flying qualities until the limits of surface deflection or rate are reached. In this case, the degradation in flying qualities is rapid and can result in loss of control due to pilot-induced oscillations or divergence. It has been found, however, that momentarily reaching the rate of deflection limit does not always result in loss of control; the time interval that a surface can remain on its rate or deflection limit depends on the dynamic pressure, the level of instability of the vehicle, and other factors. A thorough analysis of the capability of the augmentation system should be performed over the Permissible Envelope and should include variations in predicted aerodynamic terms, e.g. position and system tolerance. During flight at high angle of attack, operation of augmentation systems has caused departure, either because the aerodynamic characteristics of the surface have changed or the surface has reached its limit. During departures or spins, engines may flame out or have to be throttled back, or shut down such that limited hydraulic or electrical power is available to control the gyrations, recover to controlled flight, and restart the engine(s). The analysis of flying qualities should take into account these degraded system capabilities.

If loss of control or structural damage could occur, an inhibit should be incorporated in the system such that it cannot be engaged, or if it is already engaged, then other modes with which it is not compatible cannot be engaged. Furthermore, operation of these devices should not be capable of defeating angle-of-attack limiters, sideslip limiters, or load factor limiters that are built into the basic flight control system to provide stable and controlled flight.

REQUIREMENT LESSONS LEARNED

Following some failures, a pilot's lack of adaptation, or inappropriate adaptation, can result in a pilot/airframe closed-loop instability, even if the aircraft itself remains stable. Examples are the B-58 yaw damper and NASA-TN-D-1552.

MIL-STD-1797A
APPENDIX A

The required failure indications depend on operational rules. Consistent maintenance and checkout capability and rules are needed.

On the X-29, SCAS gains were originally a function of air data from the side-mounted probe. Large position error transonically gave erroneous gains which lowered the system's phase margin.

In certain flight conditions, turbulence intensities and failure states, performance or augmentation systems can actually degrade the flying qualities. The purpose of this requirement is to ensure that this effect is analyzed and minimized. Compliance with this paragraph is especially important to vehicles employing relaxed static stability.

5.1.12.4 Rate of control displacement-verification.

Verification shall be by analysis, simulation and flight test.

5.1.12.5 Dynamic characteristics-verification.

Verification shall be by analysis and test.

5.1.12.6 Damping-verification.

Verification shall be by analysis and flight test.

5.1.12.7 Transfer to alternate control modes-verification.

Verification shall be by analysis and flight test.

5.1.12.8 Flight control system failures-verification.

Verification shall be by analysis, simulation and flight test.

5.1.12.9 Augmentation systems-verification.

Verification shall be by analysis, simulation and flight test.

5.1.12.10 Auxiliary dive recovery devices-verification.

Verification shall be by analysis, simulation and flight test.

5.1.12.11 Direct force controllers-verification.

Verification shall be by analysis, simulation, inspection, and flight test.

VERIFICATION RATIONALE (5.1.12.4 through 5.1.12.1 1)

Verification normally will be a part of flight control system design and testing, and of flight envelope expansion.

VERIFICATION GUIDANCE

Evaluation pilots should be alert for potential operational problems in exploring the safe limits of the flight envelope. Critical conditions will usually be the corners of the expected envelopes (e.g., a SAS for power approach should be switched at the highest and lowest expected airspeeds, at low altitudes). Limited analytical and ground-based simulation may be used to supplement actual flight testing, especially in the early stages of development; but flight testing is ultimately required. The conditions examined should be in the range of those encountered operationally.

For requirements involving flight in turbulence, compliance may be shown principally through analysis of gust response characteristics using either an analytical model or a piloted simulation, involving the gust models of 4.9 and a flight-validated model of the aircraft. Such analysis must include not only the normal operational maneuvers involving pitch, roll, and yaw controls; but also the critical maneuvers (especially, for hydraulic actuation systems) which may limit the responsiveness of the control surfaces. As mentioned in Requirement Guidance, these might include extension of landing gear and high-lift devices on landing approaches, etc. Some evaluation should be conducted by flying in real turbulence.

MIL-STD-1797A
APPENDIX A

A modicum of common sense is required in the application of this requirement. The specific intensities of atmospheric disturbance to be applied are not specified. Yet section 4.9 contains turbulence up to the thunderstorm level. We do not normally require operational maneuvering in thunderstorm turbulence. It would seem reasonable to require operational maneuvering in turbulence intensities up to Moderate. For turbulence intensities greater than Moderate it seems reasonable to require sufficient maneuver capability for loose attitude control.

VERIFICATION LESSONS LEARNED

4.1.13 General trim requirements

4.1.13.1 Trim system irreversibility.

All trimming devices shall maintain a given setting indefinitely unless changed by the pilot, or by a special automatic interconnect (such as to the landing flaps), or by the operation of an augmentation device. If an automatic interconnect or augmentation device is used in conjunction with a trim device, provision shall be made to ensure the accurate return of the device to its initial trim position on removal of each interconnect or augmentation command.

4.1.13.2 Rate of trim operation.

Trim devices shall operate rapidly enough to enable the pilot to maintain low control forces under changing conditions normally encountered in service, yet not so rapidly as to cause oversensitivity or trim precision difficulties under any conditions, including:

- a. Dives and ground attack maneuvers required in normal service operation
- b. Level-flight accelerations at maximum augmented thrust from 250 knots or $V_{R/C}$ - whichever is less, to V_{max} at any altitude when the aircraft is trimmed for level flight prior to initiation of the maneuver.

4.1.13.3 Stalling of trim systems.

Stalling of a trim system due to aerodynamic loads during maneuvers shall not result in an unsafe condition. Specifically, the entire trim system shall be capable of operating during the dive recoveries of 4.2.8.6.3 at any attainable, permissible n , at any possible position of the trimming device.

4.1.13.4 Transients and trim changes.

The transients and steady-state trim changes for normal operation of control devices such as throttle, thrust reversers, flaps, slats, speed brakes, deceleration devices, dive recovery devices, wing sweep and landing gear shall not impose excessive control forces to maintain the desired heading, altitude, attitude, rate of climb, speed or load factor without use of the trimmer control. This requirement applies to all in-flight configuration changes and combinations of changes made under service conditions, including the effects of asymmetric operations such as unequal operation of landing gear, speed brakes, slats or flaps. In no case shall there be any objectionable buffeting or oscillation caused by such devices. More specific requirements on such control devices are contained in 4.2.5 and 4.1.12.10.

4.1.13.5 Trim for asymmetric thrust.

For all multi-engine aircraft, it shall be possible to trim the cockpit-control forces to zero in straight flight with up to two engines inoperative following asymmetric loss of thrust from the most critical propulsive factors (4.6.5.1). This requirement defines Level 1 in level-flight cruise at speeds from the maximum-range speed for the engine(s)-out configuration to the speed obtainable with normal rated thrust on the functioning engine(s). Systems completely dependent on the failed engines shall also be considered failed.

4.1.13.6 Automatic trim system.

Automatic trimming devices shall not degrade or inhibit the action of response limiters.

REQUIREMENT RATIONALE (4.1.13 through 4.1.13.6)

Establishing, maintaining and changing the trim or operating point are basic factors in piloting

REQUIREMENT GUIDANCE

The related MIL-F-8785C requirements are paragraphs 3.6.1.4, 3.6.1.2, 3.6.1.3, 3.6.3 and 3.6.1.1

The trim system is part of the flight control system (4.1.12), but the general trim requirements are grouped here for convenience.

The irreversibility requirement allows trim scheduling or interconnection with other control devices (e.g., flap) but it specifically disallows float or drift.

MIL-STD-1797A
APPENDIX A

It may be difficult to find a trim rate which will be good for all loadings, in all mission phases. Slow trim rates will not keep up with rapidly changing flight conditions, and so will fatigue the pilot. Too rapid trim rates give oversensitivity, make trim difficult and accentuate the effect of any runaway trim. 4.2.8.6.3 sets specific limits on forces in dives and during rapid speed changes, while trimming to decrease the forces.

While the requirement on stalling of trim systems applies generally, the problem has been encountered with pitch trim by adjusting incidence of the horizontal stabilizer. First, some of the available elevator capability goes to oppose the mistrimmed stabilizer and less is left to counter any adverse gust-induced pitching motions. Second, elevator forces will be increased and may complicate recovery from a high-speed dive. Third, and perhaps most significant, whenever the elevator opposes the stabilizer, the aerodynamic hinge moment on the stabilizer may reach a level that is impossible for the trim actuator to overcome. See, for example, AIAA Paper 64-353.

If, for example, nose-down trim is used to counter the aircraft's pitch-up response to a vertical downdraft, the aircraft will pitch down more sharply when the draft reverses in direction. Elevator will be used to counter the pitch-down motion, and the resulting aerodynamic load may be sufficient to stall the stabilizer actuator when nose-up retrim is attempted. As speed increases, the adverse effects increase, and the elevator may have insufficient effectiveness to counter the nose-down forces of the draft and the mistrimmed stabilizer. It is obvious that tuck effects may also complicate the picture, and it is significant that tuck effects cannot be countered by a Mach trim system that is unable to move the stabilizer.

In addition to requirements on the trim system, in 4.1.13.4 are limits on transients and control force changes due to operation of other controls. Besides the pitch trim change requirements of 4.2.5, we stipulate that no other control actions should add significantly to pilot workload.

REQUIREMENT LESSONS LEARNED

A Boeing 720B airliner encountered stalling of the pitch trim actuator during a turbulence upset over O'Neill, Nebraska, on 12 July 1963 (NASA CR-2677). The aircraft was passing through 39,000 ft in a climb to 41,000 ft in IMC when severe turbulence was encountered. A large downdraft was penetrated and the aircraft pitch attitude increased to +60 deg. This occurred despite application of full forward stick. The gust then reversed to a large updraft, putting the aircraft into a severe dive with an estimated flight path angle of about -35 deg. The pitch trim control was reported by the crew to be frozen in the dive. Recovery was made with power (pullout at 14,000 ft) and pitch trim control was restored.

Two other turbulence upsets occurred with commercial jet transports (another Boeing 720B and a DC-8), in which the wreckage of both aircraft showed the trim actuator in the full nose-down position. The frequency of such turbulence upset accidents has been reduced drastically in recent years by pilot training to fly loose attitude control and to essentially ignore large airspeed excursions in severe turbulence. However, the possibility of entering a dive with full nose-down mistrim should be considered in the design process.

KC-135, B-57 and other aircraft have been lost due to runaway trim, so that now elaborate precautions are commonly taken to preclude dangerous trim runaway, trim and control use of the same surface, or trimming by adjusting the null position of the feel spring through a limited range. Civil airworthiness regulations have long required ability to continue flight and land safely with maximum adverse trim.

Autotrim can be insidious. Several B-58s are thought to have been lost because the pitch autotrim would allow approach to stall angle of attack with no indication whatsoever to the pilot until very close to stall. Attitude-hold stabilization has a similar effect with the pilot's hand lightly on the control. Pitch autotrim does not promote holding airspeed, and a number of trim and stabilization mechanizations need the addition of some form of stall and overspeed limiters.

5.1.13 General trim requirements-verification

5.1.13.1 Trim system irreversibility-verification.

Verification shall be by analysis and test.

5.1.13.2 Rate of trim operation-verification.

Verification shall be by analysis, simulation and flight test.

5.1.13.3 Stalling of trim systems-verification.

Verification shall be by analysis and flight test.

5.1.3.4 Transients and trim changes-verification.

Verification shall be by analysis, simulation and flight test.

5.1.13.5 Trim for asymmetric thrust-verification.

Verification shall be by analysis, simulation and flight test.

5.1.13.6 Automatic trim system-verification.

Verification shall be by analysis, simulation and flight test

VERIFICATION RATIONALE (5.1.13 through 5.1.13.6)

Most flight verification will be accomplished during the normal course of the flight test program.

VERIFICATION GUIDANCE

Flight test crews should monitor trim system characteristics throughout the program to note any discrepancies. Of special interest are extreme loadings and corners of the flight envelope including sustained maneuvers at $n \neq 1$, e.g., dives and dive recoveries, pullups, wind-up turns, with the cockpit trim setting fixed throughout--and for trim rate, rapid speed changes and configuration and thrust changes. Check at the highest trim-system loadings, which may be the critical test of irreversibility.

It is clear that full nose-down mistrim should be accounted for in the dives. For example, a Boeing 720 with full nose-down trim at the dive entry will encounter stalling of the pitch trim drive in the dive if the pilot is, manually attempting to pull out. Judgment will have to be applied to decide if the mission requirements and failure considerations such as runaway trim or trim actuation power failure should allow this type of abuse. See Requirement Lessons Learned for more discussion of this. FAA Advisory Circular 25.253-1A gives guidance on design upset maneuvers for civil transport airplanes.

External stores can affect both stability and the zero-lift pitching moment as well as the aircraft loading.

VERIFICATION LESSONS LEARNED

4.2 Flying qualities requirements for the pitch axis

Control force and deflection have both been found universally to be important pilot cues, so both controls-fixed and controls-free (control deflection and force) characteristics have been specified. Although control of the flight path may be the pilot's ultimate aim, pitch attitude control is commonly used as a surrogate.

4.2.1 Pitch attitude dynamic response to pitch controller

4.2.1.1 Long-term pitch response.

Any oscillation with a period of 15 seconds or longer shall have the following damping: Except as may be provided in 4.4.1, 4.4.1.1 and 4.2.1.2, no aperiodic flight path divergence is allowed within the Service Flight Envelope for any Level of flying qualities. These requirements apply with cockpit controls fixed and with them free.

REQUIREMENT RATIONALE (4.2 through 4.2.1.1)

The long-term response, characteristically the phugoid mode involving airspeed and pitch attitude, is important in unattended or divided-attention operation, as well as being the means through which speed is regulated.

REQUIREMENT GUIDANCE

The applicable MIL-F-8785C requirement is paragraph 3.2.1.2. Recommended values, as in MIL-F-8785C, are based on the data and analysis presented in AFFDL-TR-69-72:

Level 1	equivalent $\zeta_p > 0.04$
Level 2	equivalent $\zeta_p > 0$
Level 3	$T_2 \geq 55$ seconds

The equivalent phugoid damping ratio, ζ_p , is to be determined from the three-degree-of-freedom equivalent classical longitudinal response; i.e. the transfer function

$$\frac{\theta}{\delta_{es}} \quad \text{or} \quad \frac{\theta}{F_{es}} = \frac{K_{\theta} (s + 1/T_{\theta_1}) (s + 1/T_{\theta_2}) e^{-\tau_e s}}{[s^2 + 2\zeta_p \omega_p s + \omega_p^2] [s^2 + 2\zeta_{sp} \omega_{sp} s + \omega_{sp}^2]}$$

is matched to the actual frequency response to determine best-fit values of the equivalent-system parameters. The Level 3 requirement, stated in terms of time to double amplitude, is to be checked directly from the time response of the actual aircraft, for both nose-up and nose-down control impulses. In practice this matching should seldom be necessary: either a single lightly-damped mode will stand out at low frequency or no more than a glance will be needed to see that the requirement has been more than met. In unaugmented aircraft the phugoid is the lightly damped oscillation at which this requirement is aimed. If stability augmentation suppresses the phugoid, the requirement obviously has been met and exceeded; then the only concern will be that the augmentation has not introduced other difficulties.

We might consider an additional Level 3 requirement, to cover the case of two unstable phugoid roots, which has been encountered. Such a limit is probably a good idea, but data are insufficient to establish a firm value.

MIL-STD-1797A
APPENDIX A

Two other factors have been observed to alter this mode: thrust offset and compressibility; a stability derivative M_u can result from vertical placement of the thrust line relative to the center of mass; too much M_u of either sign can be destabilizing and cause increased trim changes and gust response. The transonic trim change or tuck tendency is restricted in 4.4.1.1. Supersonically the common, slight long-term instability from lift-curve slope decrease with increasing Mach number has not generally been a noticeable flying qualities problem. However, at Mach 3 the XB-70 experienced a troublesome sensitivity of flight path to pitch attitude, a different but perhaps related problem.

Simple approximations for classical phugoid frequency and damping (valid only at subsonic speeds, see AFFDL-TR-65-218) involve only airspeed, L/D and the static and maneuver margins (Etkin, "Dynamics of Atmospheric Flight"):

$$\omega_p^2 \doteq 2 \left(\frac{g}{V} \right)^2 \left(\frac{-C_{m\alpha}/C_{N\alpha}}{N_m - c.g.} \right) = 2 \left(\frac{g}{V} \right)^2 \frac{h_n}{h_m} \doteq 2 \left(\frac{g}{V} \right)^2$$

$$2\zeta_p \omega_p \doteq 2 \left(\frac{g}{V} \right) \frac{C_D}{C_L}$$

in an exchange of kinetic and potential energy at constant angle of attack. Combinations of stability augmentation, center-of-gravity variation with loading, thrust, and compressibility can cause an unstable phugoid oscillation, its decomposition into two aperiodic roots (with a possible divergence) or a restructuring which involves the short-period roots as well.

Although AFWAL-TR-83-3015 indicates a damping ratio somewhat less than 0.04 to be satisfactory for the L-1011 transport, we have chosen to recommend the MIL-F-8785B/C values on the bases that (a) they are derived from systematic flight evaluations and (b) with relaxed static stability seeming to become the norm, stability augmentation should not frequently be required only in order to meet the phugoid requirement. When employed, the augmentation should improve rather than degrade the long-term response.

Note that for the entire data base, all other aircraft response modes are stable. Although little data exists on multiple Level 3 flying qualities, some such combinations can be unflyable.

REQUIREMENT LESSONS LEARNED

While stability augmentation can easily improve the phugoid damping, the reverse has also been observed AFWAL-TR-81-3118 reports simulation of two stability augmentation schemes for a basically unstable airframe. Pitch rate feedback with forward-loop integration eliminated the phugoid mode. Angle-of-attack feedback, however, at high gain actually reduced phugoid damping. Evidently the small angle-of-attack contribution had improved the damping, so reducing the excursions affected it adversely.

Pitch attitude stabilization, or integration of pitch rate feedback, improves the phugoid damping but, at least for high gain, restricts the maximum steady normal acceleration and makes $d\delta/dV$, the static stability indicator, zero. Even for terminal flight phases, where required maneuverability is not great, some adjustments are helpful. Several investigators have found that pilots appreciate the further addition of a turn coordination feature that eliminates the steady control force in coordinated turns, thus removing an undesirable feature of such augmentation, the need to push forward to recover. Similarly, Calspan (NASA-CR-172491) has found it beneficial to insert a 0.2 r/s washout so that the nose drops normally, as speed bleeds off in a flare or landing. Without the washout, a nose-down correction to lose altitude requires pushing on the stick—an unnatural action which pilots are reluctant to do near the ground, at least until they learn the technique well. However, that same washout, it was found, would saturate the Shuttle cockpit controller when the pilot pushes over to capture the glide slope.

Also, since the effectiveness of attitude or integrated angular rate stabilization depends upon the lift-curve slope (stabilization drives a transfer function's poles toward its zeros, and the zero at $-1/T_{\theta_1}$, generally changes sign as stall is approached), angle-of-attack limiting or inhibition may be necessary (WADC-TR-58-82) with pitch feedback:

$$\begin{aligned} \frac{1}{T_{\theta_1}} &\doteq -X_u + \frac{Z_u X_u}{Z_w} \left(\frac{1 - \frac{Z_\delta M_u}{M_\delta Z_u}}{1 - \frac{Z_\delta M_w}{M_\delta Z_w}} \right) \\ &\doteq \frac{2g}{V} \left\{ \left(\frac{T}{W} - \frac{V}{2} \frac{\partial(T/W)}{\partial u} \right) \cos(\alpha + i_t) - \gamma \right. \\ &\quad \left. + \frac{C_{L1} \left[1 - \frac{T}{W} \sin(\alpha + i_t) - C_{D\alpha}/C_{L1} \right]}{C_{N\alpha} \left(1 - \frac{C_{L\delta} C_{m\alpha}}{C_{m\delta} C_{N\alpha}} \right)} \left[1 + \left(\frac{Z_T}{\bar{c}} \frac{C_{L\delta}}{C_{M\delta}} \right) - \sin(\alpha + i_t) \left(\frac{T}{W} - \frac{V}{2} \frac{\partial(T/W)}{\partial u} \right) \right] \right\} \\ &\doteq \frac{2g}{V} \left[\frac{C_{D0}}{C_L} + C_L \left(\frac{1}{C_{L\alpha}} - \frac{\partial C_D}{\partial C_L^2} \right) \right] \end{aligned}$$

the latter approximation holding for $C_{L\alpha} \gg C_D$, parabolic drag (where C_{D0} , is the zero-lift drag) and neglecting thrust effects and $C_{L\delta}$. Note that in terms of the low-frequency path zero, from Aircraft Dynamics and Automatic Control:

$$\frac{1}{T_{h_1}} \doteq \frac{1}{T_{\theta_1}} - \frac{g}{V} \frac{Z_u}{Z_w} \left(\frac{1 - (Z_\delta/M_\delta)(M_u/Z_u)}{1 - (Z_\delta/M_\delta)(M_w/Z_w)} \right)$$

so that generally $1/T_{\theta_1}$ approaches zero at some angle of attack above that for zero $1/T_{h_1}$, or $d\gamma/dV$. These transfer-function numerator approximations apply only to cases of stabilization and control through the same moment effector.

5.2 Flying qualities requirements for the pitch axis-verification

5.2.1 Pitch attitude dynamic response to pitch controller-verification

5.2.1.1 Long-term pitch response-verification.

Verification shall be by analysis, simulation and flight test.

VERIFICATION RATIONALE (5.2 through 5.2.1.1)

Testing specifically for long-term flight characteristics is time-consuming. However, most long-term deficiencies will surface during attempts to stabilize at a new flight condition, for example establishing a steady climb or turn, changing airspeed, or flaring for landing.

MIL-STD-1797A
APPENDIX A

VERIFICATION GUIDANCE

Some mechanizations of stability augmentation may greatly enhance phugoid damping, but at the same time alter some steady-state flight characteristics: for example, holding a new pitch attitude after removal of a pilot command. Test pilots will need to evaluate any unusual characteristics qualitatively (Supersonic Transport Aeroplane Flying Qualities).

VERIFICATION LESSONS LEARNED

MIL-STD-1797A
APPENDIX A

4.2.1.2 Short-term pitch response.

The short-term pitch response shall meet the following requirements for control inputs of all magnitudes that might be experienced in service use: _____.

REQUIREMENT RATIONALE (4.2.1.2)

Pitch control of conventional aircraft is a vital element of flying qualities, both as a primary control axis (for example, in pointing the aircraft during gunnery) and as an indirect way of controlling the aircraft flight path (for example, in glide path control for landing).

REQUIREMENT GUIDANCE

The related MIL-F-8785C paragraphs are 3.1.12, 3.2.2.1, 3.2.2.1.1, 3.2.2.1.2, and 3.5.3.

Short-term is defined in terms of a frequency range or a time span. The short-term pitch response characteristics are universally regarded to be extremely important--so important that controversy over both the form and the substance of requirements has continued for some years. Although we have found that the existing data base may be extended by means of the equivalent system concept to cover a number of more elaborate stability augmentation applications, problems remain. Of course there are bound to exist some configurations that just don't fit. But even among the ones that do, several questions remain unresolved, including:

Effects of pilot location and blended direct lift control have been observed and need to be accounted for

A continuing controversy over the merits of n/α vs $1/T_{\theta_2} = (g/V) (n/\alpha)$ has not yet been resolved

Various forms of Bihrl's Control Anticipation Parameter (CAP) relating initial pitching acceleration to steady-state normal acceleration have been tendered

Tolerable values of effective time delay need to be pinned down more fully

Task dependence needs to be explored more fully

There are those who prefer, or insist upon, a time-domain form of criteria. (In the world of linear systems a duality exists between time and frequency responses, so the question becomes just what details the requirements should emphasize.)

We feel that the $\zeta_{sp}, \omega_{sp}, n/\alpha$ form of MIL-F-8785B/C not only fits the data but has demonstrated its effectiveness for a number of highly augmented aircraft as well as for classical response. That, then, is the approach normally to be preferred. Also, presented herein are statements in terms of equivalent $\omega_{sp} T_{\theta_2}$ instead of $\omega_{sp}^2/(n/\alpha)$. A time-domain alternative, based on second-order response but usable directly with some higher-order responses, is also given. For cases with no good equivalent system match, frequency-response criteria involving Nichols charts or the bandwidth of the actual higher-order system are presented. We hope that current research will clarify the outstanding issues.

OUTLINE OF 4.2.1.2 GUIDANCE

In the meantime we present a preferred form (CAP) followed by alternatives:

- | | |
|---|----------|
| A. CAP or $\omega_{sp}^2/(n/\alpha), \zeta_{sp}, \tau_{\theta}$ | Page 172 |
| B. $\omega_{sp} T_{\theta_2}, \zeta_{sp}, \tau_{\theta}$ | 190 |

MIL-STD-1797A
APPENDIX A

C. Transient peak ratio, rise time, effective delay	217
D. Bandwidth, time delay	225
E. Pilot-in-the-loop criteria	237
F. Drop back and Nichols-chart aircraft boundaries	244

We strongly suggest using several or all of these criteria in an aircraft design, although that probably would not be practical in a specification.

The large amount of this guidance reflects the importance of short-term pitch response, the high attention it has been given, and the great need for further study to derive a clear-cut, generally applicable set of requirements.

Equivalent systems and their determination are discussed under the recommended form of short-term requirement, A. CAP..., followed by various different interpretations of CAP, possible modifications, and for Level 3 the allowance of a slight instability. Supporting data for CAP are deferred to B, $\omega_{sp} T_{\theta_2}$, since the same data and similar interpretations are involved. The discussion groups the Level 1 and Level 2 supporting data for conventional aircraft by Flight Phase Category, according to the flight tasks which were rated. For each Flight Phase, first $\omega_{sp}^2/(n/\alpha)$ and then $\omega_{sp} T_{\theta_2}$ is treated. The data base (Neal-Smith and LAHOS) is discussed describing complications due to stability and control augmentation. The Level 3 requirements, repeated under each heading A - F, are based on other considerations, as discussed at the end of Section A. Supporting data for Level 3 are presented at the end of Section B, under "Equivalent System Data."

Several other approaches are then given and discussed: Hoh's bandwidth criteria, Chalk's time-response parameters, the Neal-Smith closed-loop criteria and Gibson's combination of time- and frequency-response rules. These criteria should be useful as additional design guidance, or one or more of them can be used when the recommended form does not work. Supporting data are given for each form.

While normally force is considered the primary cue of pilot feel, both control force and control position are significant. With a deflection control system, force feel will lag deflection because of the finite bandwidth of the feel system. Where a pilot-force pickoff (say, a strain gauge) is used, any significant deflection of the pilot control is effected through a follow-up. It has been found that a displacement controller should not be penalized unduly for the feel-system lag, since pilots sense both stick input and stick output and can compensate. The response requirements are to be applied to pilot control inputs accordingly.

A. CAP or $\omega_{sp}^2/(n/\alpha)$, ζ_{sp} , τ_{θ}

The recommended requirement is:

The equivalent pitch rate and normal load factor transfer-function forms for pilot control-deflection or control-force inputs

$$\frac{q(s)}{\delta_{es} \text{ or } F_{es}(s)} = \frac{K_{\theta} s (s + 1/T_{\theta_1}) (s + 1/T_{\theta_2}) e^{-\tau_{\theta} s}}{[s^2 + 2\zeta_p \omega_p s + \omega_p^2] [s^2 + 2\zeta_{sp} \omega_{sp} s + \omega_{sp}^2]}$$

$$\frac{n'_z(s)}{\delta_{es} \text{ or } F_{es}(s)} = \frac{K_n s (s + 1/T_{h_1}) e^{-\tau_n s}}{[s^2 + 2\zeta_p \omega_p s + \omega_p^2] [s^2 + 2\zeta_{sp} \omega_{sp} s + \omega_{sp}^2]}$$

simultaneously shall be fit to the corresponding actual response of the aircraft over a frequency range of 0.1 to 10 radians per second. The parameter n'_z is normal acceleration at the instantaneous center of

MIL-STD-1797A
APPENDIX A

rotation for pilot pitch control inputs. Corresponding matches shall be made for pilot control-deflection inputs. The requirements apply to the equivalent-system parameters determined from the best match for force inputs, and also for deflection inputs; the procuring activity will be the judge of the adequacy of the matches. The parameter CAP is to be estimated from the equivalent-system parameters $1/T_{\theta 2}$ and ω_{sp} [in ft-lb-rad-sec units; $n/\alpha \doteq (V/g) (1/T_{\theta 2})$] or alternatively

$$CAP = \omega_{sp}^2 (\dot{q}_{\max HOS}) / [(n/\alpha)(\dot{q}_{\max LOES})]$$

where HOS refers to the actual higher-order system and LOES refers to the equivalent lower-order system; \dot{q}_{\max} is the peak value of pitching acceleration for a step input of pilot force or deflection.

In addition to the requirements of figure 13, for Category C Flight Phases, ω_{sp} and n/α shall be at least:

CLASS	LEVEL 1		LEVEL 2	
	min ω_{sp}	min n/α	min ω_{sp}	min n/α
I, II-C, IV	0.87r/s	2.7g/rad	0.6r/s	1.8g/rad
II-L, III	.7	2.0	0.4	1.0

For Level 3, T_2 , the time to double amplitude based on the value of the unstable root, shall be no less than 6 seconds. In the presence of any other Level 3 flying qualities, ω_{sp} shall be at least 0.05 unless flight safety is otherwise demonstrated to the satisfaction of the procuring activity. T_2 applies to the value of an unstable first-order root: $T_2 = -(2/n)/\lambda$ where λ is the value of the unstable root.

Requirements on the equivalent pitch time delay, τ_{θ} , apply to the value for $\theta(s)/\delta_{es}(s)$ for a deflection control system (pilot controller deflection commands the control effectors) and to $\theta(s)/F_{es}(s)$ for a force control system (pilot controller force commands the control effectors):

LEVEL	ALLOWABLE TIME DELAY
1	0.10 sec
2	0.20
3	0.25

In the event that an adequate match cannot be found, the contractor with the concurrence of the procuring activity, shall substitute an alternative requirement.

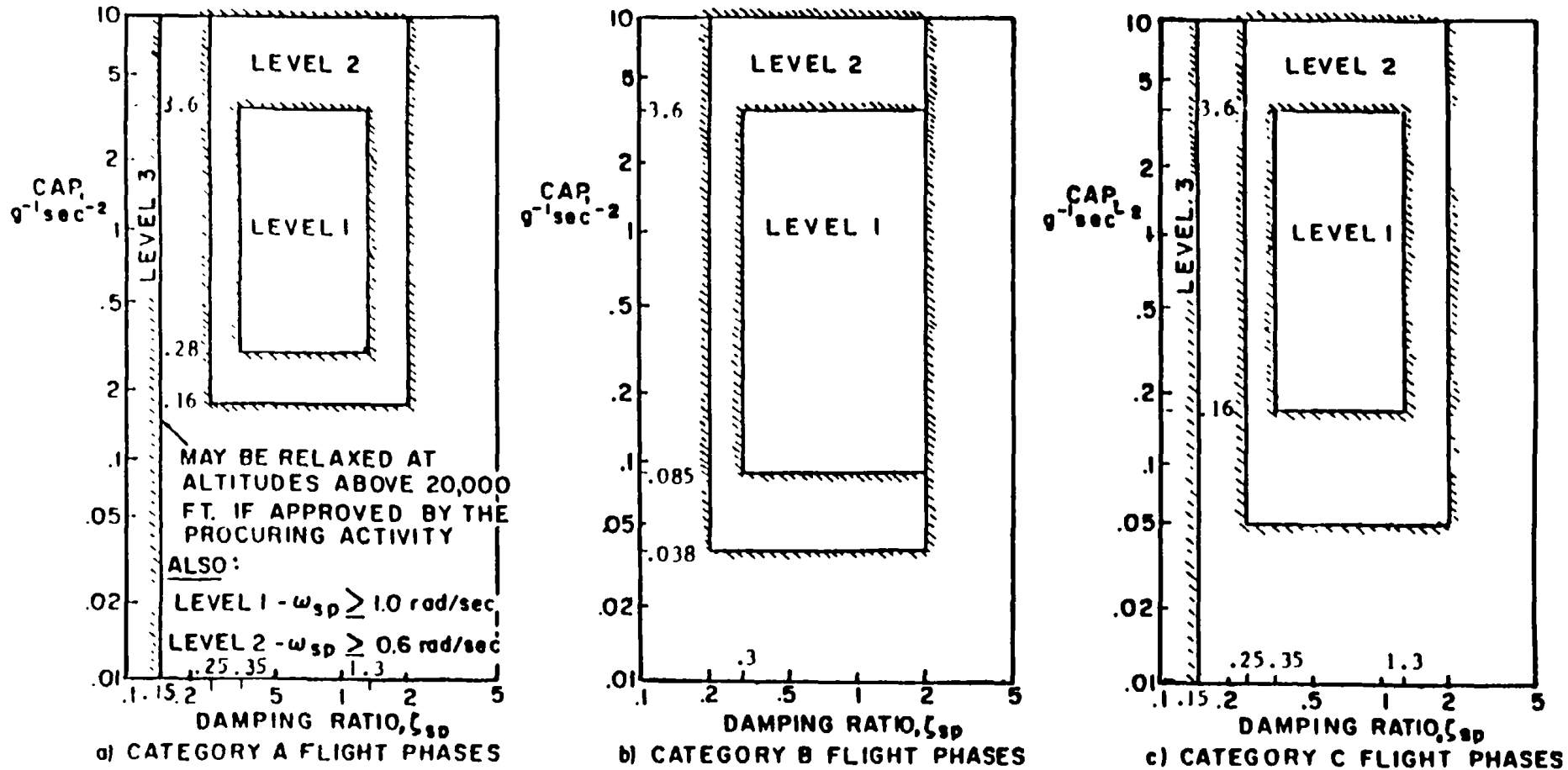

FIGURE 13. Short-period dynamic requirements.

THE EQUIVALENT SYSTEMS CONCEPT

The advent of high-order feedback control systems has required specification of flying qualities parameters for systems of, for example, twentieth order or more. Some of the additional modes may no longer be well separated in frequency from $1/T_{\theta 1}$, $1/T_{\theta 2}$, ω_p and ω_{sp} . In fact there are commonly a number of high-order system characteristic roots in the short-period frequency range.

One approach to reducing the order of these systems for specification purposes would be to choose a suitable short-period pair of roots from the high-order array. This was done either by picking dominant roots (the most suitable pair) or by root tracking (identifying the locus of aircraft short-period roots as the various feedback pins were increased). Considerable experience in recent years indicates that such an approach will lead to unsatisfactory handling qualities. A clear responsibility of the standard is therefore to discourage that particular type of order reduction. Considerable research has been devoted to order reduction by matching frequency responses to obtain low-order equivalent systems. This concept, originally developed more than ten years ago (AFFDL-TR-70-74 and Systems Technology Inc., TR- 190-1), has been refined considerably (for example, see AIAA Paper 77-1122, AIAA Paper 79-1783, MDC Rpt A6792, AIAA Paper 80-1611-CP, AIAA Paper 80-1627-CP, "Analysis of High Order Aircraft/Flight Control System Dynamics Using an Equivalent System Approach", "Handling Qualities of Aircraft with Stability and Control Augmentation Systems -- A Fundamental Approach," "Equivalent Systems Approach for Flying Qualities Specification," and MDC Rpt A5596). Since this approach has the advantage of including the effects of adjacent modes, is easily related to previous specifications, and identifies important delay effects, it is recommended. In AFWAL-TR-82-3064 Gentry describes matching techniques, Hodgkinson and Wood discuss the effects of mismatch and Bischoff shows how to allow for the higher-order system effect of reducing the maximum pitching acceleration for a step input.

The use of lower-order equivalent systems allows us to extend to many higher-order systems the application of well-established boundaries generated from classical airplane data, i.e., MIL-F-8785C. More specifically, requirements for pitch axis control have set boundaries on the classical modal parameters in¹

$$\frac{\theta(s)}{\delta(s)} = \frac{M_{\delta} (1/T_{\theta 1}) (1/T_{\theta 2}) e^{-\tau\theta s}}{[\zeta_p ; \omega_p] [\zeta_{sp} ; \omega_{sp}]}$$

This expression is a linearized, reduced-order model of the actual aircraft response. In most cases the phugoid and short period modes are sufficiently separated that further order reduction is possible as follows:

$$\frac{M_{\delta} Z_w (1/T_{\theta 1})}{M_{\alpha} [\zeta_p ; \omega_p]} \quad \text{and} \quad \frac{M_{\delta} (1/T_{\theta 2}) e^{-\tau\theta s}}{s [\zeta_{sp} ; \omega_{sp}]}$$

Phugoid Short Period

These expressions, universally recognized as pitch models of phugoid and short-period dynamics within appropriate respective frequency ranges, may normally be used in place of the three-degree-of-freedom pitch equivalent system specified; likewise with normal load factor.

¹ In this shorthand notation (1/T) represents (s + 1/T) and $[\zeta; \omega]$ represents $[s^2 + 2\zeta\omega s + \omega^2]$

While no specific guidance on the lower frequency bound of the matching region is offered, the phugoid and short period are generally separated by at least a factor of 10, which should be adequate to consider them separately. The assumption of widely separated phugoid and short period modes breaks down at low values of static stability (i.e., $M_\alpha = 0$) such as for conventional aircraft with extreme aft center of gravity locations and on most STOL configurations. (Transonic tuck occurs when a nose-down pitching moment with increasing Mach number causes the phugoid poles to split into two real roots, which may become large. That is a separate issue, covered in 4.4.1.1.) In this region of near-neutral stability, pilot ratings seem to be insensitive to the exact root locations and are Level 2 as long as damping is sufficient (AFWAL-TR-82-3014, AFFDL-TR-72-143, etc.). In that case Schuler's criteria (AFWAL-TR-82-3014) are the best available, though they are not given here because they are not based on flight experience. A key issue during the development of the lower-order equivalent system (LOES) approach was whether to fix or free $1/T_{\theta_2}$ during the fitting process. When $1/T_{\theta_2}$ is allowed to be free it can take on very large (or small) values. If its physical significance were related purely to attitude control, it would be appropriate to utilize the freed value when making comparisons with the criterion boundaries. However, considerable evidence indicates that the role of $1/T_{\theta_2}$ in the correlations of classical aircraft is more related to the lag from the response in attitude to the response in path:

$$\frac{\gamma(s)}{\theta(s)} = \frac{N_{Fes}^\gamma / \Delta}{N_{Fes}^\theta / \Delta} \doteq \frac{1}{T_{\theta_2} s + 1}$$

Then the $\omega_{sp}^2 / (n/\alpha)$ boundaries would be interpreted as a specification on path as well as attitude control. The appropriate value of n/α to plot on the criterion would therefore be the fixed (real) one: with a single control surface (e.g., no DLC), simple block-diagram algebra shows that no augmentation can change the dynamic relationship of pitch to heave motion.

An example of the differences with $1/T_{\theta_2}$ fixed and free is seen in table XII (taken from MDC Rpt A6792 fits of the AFFDL-TR-70-74 data). It can be seen that substantial differences in all the effective parameters exist between the $1/T_{\theta_2}$ -fixed and -free fits. Hence the dilemma is not a trivial one.

TABLE XII. Examples of variations in LOES parameters with $1/T_{\theta_2}$ fixed and free.

CONFIGURATION	$1/T_e$		ω_e		ζ_e		τ_e	
	FIXED	FREE	FIXED	FREE	FIXED	FREE	FIXED	FREE
1A	1.25	0.43	3.14	2.54	0.39	0.65	0	0.020
1G	1.25	176.	0.78	1.55	0.74	1.07	0.185	0.043
2H	1.25	4.08	2.55	3.80	0.80	0.52	0.126	0.098
4D	1.25	5.25	3.47	4.61	0.58	0.23	0.169	0.111

In general, the lower-order approximation will always retain the proper relationship between attitude and flight path if the pitch-rate and normal-acceleration transfer functions are matched simultaneously. Although the importance of pilot location to the assessment of flying qualities has been demonstrated (e.g., AFWAL-TR-81-3118), at present our understanding is insufficient to account for it. Therefore in order to

avoid the introduction of more extraneous parameters we use n'_z , the normal acceleration at the instantaneous center of rotation (at $x_{cr} = Z_{\delta}/M_{\delta}$ the initial n_z response to a step control surface input is zero. It is assumed that measurements of θ and n'_z are in level, symmetrical flight, so that $\dot{\theta} = q$). Conventional subscripts on the equivalent dynamics are retained for consistency; equivalent is implicit.

Normally, for short-term pitch control the numerator of the normal-acceleration transfer function has two high-frequency factors which can be either complex or real, depending upon the point chosen along the body: $a_z = \ddot{z} - l_x \ddot{\theta}$. A point can be found (the instantaneous center of rotation) at which the two factors are extremely high frequency and so can be ignored, leaving the a_z / δ_{es} numerator a constant (in 2 degrees of freedom) for most aircraft. The technique of simultaneously matching pitch and center-of-rotation load-factor responses is based on this supposition. [Actually the classical n_z response at the instantaneous center of rotation is only approximated with this simplified numerator; the generally small difference is taken up in the time delay, τ_n , which is not forced to equal τ_{θ} .] It guarantees the same frequency and damping ratio in both responses, as well as a dynamic relation of flight path to pitch rate conforming to kinematic and physical principles, without introducing unnecessary new parameters. Allowing τ_n to be free should partially account for the neglected zeros and any other differences.

However, we have come across two exceptions to the validity of this constant-numerator approximation for the short-term n_z response. Poles and zeros added by the stability and control augmentation may cancel in some transfer functions but not others. Also, multiple surfaces may not all have the same dynamics -- for example a washed-out direct-lift nap tied to the pitch controller. For these cases we recommend using an equivalent $(n/\alpha)_e$ obtained from the equivalent T_{θ_2} :

$$(n/\alpha)_e = (V/g) (1/T_{\theta_2})_e$$

and using good judgment in assessing the validity of the match. Direct-lift control effects on flying qualities are treated further in 4.3, to the extent that present knowledge will permit.

This usage is the result of lengthy discussions about the significance of $1/T_{\theta_2}$. Proponents of holding $1/T_{\theta_2}$ fixed argued that n/α in the specification is centered about path control. Holding $1/T_{\theta_2}$ fixed at the value determined from the lift curve slope, on the other hand, preserves the known path to attitude relationship given above. Free $1/T_{\theta_2}$ tends to gallop to large values for aircraft with known deficiencies, thereby, revealing the existence of a problem. For example, a current high-performance fighter is known to be rated excessively sluggish (Level 2) in the power approach flight condition. Figure 14 shows the characteristics with $1/T_{\theta_2}$ fixed and free. For $1/T_{\theta_2}$ fixed, the sluggish response is manifested as excessive effective time delay (0.15 sec) whereas for $1/T_{\theta_2}$ free the deficiency is manifested as an n/α which falls on the lower specification boundary. Finally, utilizing the $1/T_{\theta_2}$ -free fit to ω_{sp} but plotting the fixed value of n/α actually predicts an airplane with excessive abruptness (plots above the upper limit in figure 14). In this case, as in most such instances, either method predicts the same Level of flying qualities but manifests the causes very differently.

It should be noted that a perfect fit using both the attitude and flight path transfer functions will always (for a single pitch control surface) yield the fixed value of $1/T_{\theta_2}$. However, if there are lags, such as from a stick prefilter, introduced at frequencies in the middle of the fitting region, the fit may be marginal: whereas the lower-order equivalent system (LOES) of the θ/F_{es} transfer function is of first over second order, with a first-order low-pass prefilter a good-fitting lower-order system turns out of form a first- over third-order transfer function.

τ_e values shown are equivalent delays in seconds

$$M \text{ is mismatch, } 20/n \sum (\Delta G_{db}^2 + .02 \Delta P_{deg}^2)$$

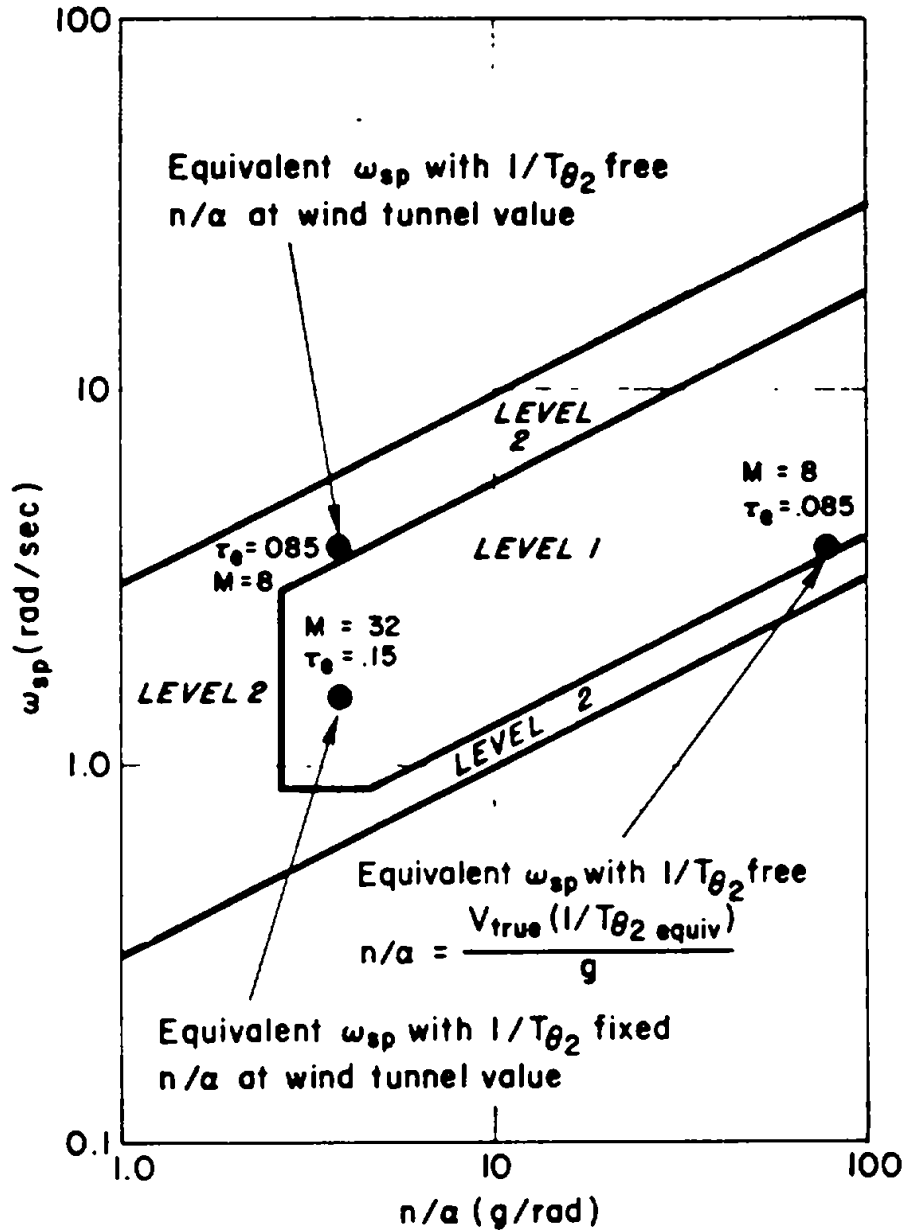

FIGURE 14. Effect of fitting with $1/T_{\theta_2}$ fixed and free, Category C requirements.

The problem can be approached in two ways: 1) we can ignore the mismatch and use the LOES model; or 2) we can utilize LOES modes more appropriate to the controlled element rather than being constrained to a first- over second- order. The problems with the second alternative are that our data base is for classical unaugmented airplanes, and that the requirements would vary with mechanization of the flight control system -- a concept we prefer to avoid. The consequence of the first alternative is that the fitting routine could come up with parameter values which are not physically meaningful. The consensus was to accept the mismatch (Alternative No. 1), rather than attempt to expand the criterion.

DETERMINATION OF EQUIVALENT SYSTEMS; MISMATCH

The equivalent lower-order parameters for this section may be obtained by any means mutually agreeable to the procuring agency and contractor. The equivalent system matching routine outlined in Appendix A is provided as guidance to indicate the expected level of rigor in the matching procedure. The representation specified in the requirement is not intended to require complex denominator roots, i.e. the denominator may have two first-order roots rather than an oscillatory pair. In this case the short-period roots are, with $\zeta_{sp} > 1$:

$$1/T_1, 1/T_2 = \zeta\omega \pm \omega\sqrt{\zeta^2 - 1}$$

The parameters of the specified equations should be obtained by matching the high-order pitch response and the normal load factor response from ω_1 to ω_2 with the frequencies defined as follows:

- ω_1 Normally 0.1 rad/sec but $> \omega_p$
- ω_2 Normally 10 rad/sec, but $>$ the resulting equivalent ω_{sp} and $1/T_{\theta_2}$

Thus iteration may be necessary in uncommon cases. The purpose is to assure that the dynamics of the equivalent airframe are adequately defined, without requiring unusually low- or high-frequency end points in the match. Pilot control inputs up to 20 r/s have been observed, but the cutoff frequency for effective piloted control of highly maneuverable aircraft seems to be slightly less than 10 r/s.

There is currently insufficient data to place definitive requirements on mismatch between the HOS and LOES. It should be noted, however, that the question of mismatch is inherent in any n-dimensional specification of an m-dimensional response, when $n < m$ (Hodgkinson in AGARD-CP-333). For equal weighting at all frequencies, mismatch is defined as:

$$M = \sum (\Delta G)^2 + K \sum (\Delta \phi)^2 \\ = \sum (G_{HOS} - G_{LOES})^2 + K \sum (\phi_{HOS} - \phi_{LOES})^2$$

where G is the amplitude in dB and ϕ is the phase in radians. ΔG and $\Delta \phi$ are calculated at discrete frequencies between ω_1 and ω_2 evenly spaced on a logarithmic scale and may be compared with the envelopes in figure 15. The significance of a given frequency can be judged by the latitude of match allowed.

A brief NT-33 landing approach simulation tackled the question of mismatch (AIAA Paper 79-1783 and AFWAL-TR-81-3116). High-order systems and simulations of their low-order equivalents were flown. The experiment indicated that very large mismatches proved unnoticeable to pilots (a sum-of-squares mismatch around 200 in the frequency range of $0.1 < \omega < 10$ rad/sec compared to the previous arbitrary limit of 10).

MDC Rpt A6792 offers a theory to explain the adequacy of such large mismatches. By examining pilot rating differences between pairs of configurations in previous NT-33 data (AFFDL-TR-78-122 and

MIL-STD-1797A
APPENDIX A

AFFDL-TR-70-74), frequency response envelopes were derived. Each pair of configurations consisted of an unaugmented, low-order aircraft response and a high-order system formed by adding terms to the low-order response; figure 15 shows the envelopes that were derived. Some rough guidance is available from these envelopes, which are an approximate measure of maximum unnoticeable added dynamics.²

As would be expected, the pilots were most sensitive to changes in the dynamics in the region of crossover (1 - 4 rad/sec). Mismatches between the HOS and LOES in excess of the values shown in the figure 15 envelopes would be cause to suspect that the equivalent parameters may not accurately predict pilot opinion. In such cases it is recommended that criteria applicable directly to the actual system, such as some of those in following section of this guidance, be used in place of the equivalent system form.

Additional comments on the use of equivalent systems may be found in AGARD-CP-260 and "Low-Order Approaches to High-Order Systems: Problems and Promises". The influence of mid-frequency added dynamics on LOES was discussed in "Low-Order Approaches to High-Order Systems: Problems and Promises", where it was shown that a series of (possibly unrealistic) lead/lag combinations evaluated in the Neal-Smith inflight simulation (AFFDL-TR-70-74) produce LOES parameters which are not necessarily equivalent to their classical counterparts. Of the ten configurations with added lead/lag dynamics, only five are predicted accurately. For the five that failed, the equivalent dynamics (ζ_e , ω_e , τ_e) were predicted to have Level 1 flying qualities but were rated Level 2 by the pilots. Table XIII lists the dynamics of the HOS and LOES for these configurations. With the exception of Configuration 1C, all have $\zeta_e < 0.5$ (though still greater than 0.35). Three have $\tau_e = 0$. All but 1C have a first-order lag near the short-period frequency; 1C has a first-order lead near ω_{sp} .

² The basic aircraft dynamics were modified via equalization networks. Modifications that resulted in 1 pilot rating change were defined as maximum unnoticeable added dynamics.

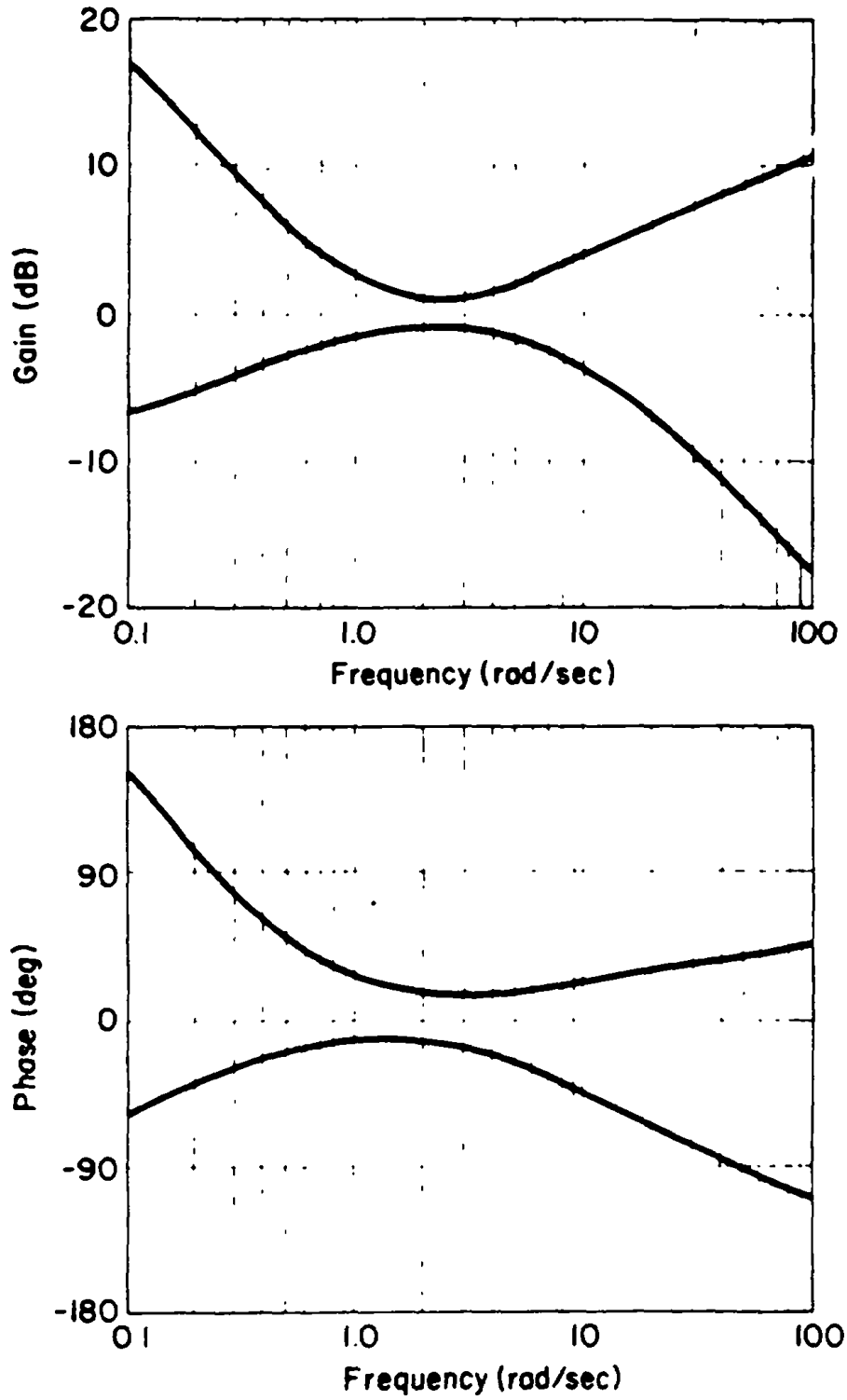

FIGURE 15. Envelopes of maximum unnoticeable added dynamics (AFWAL-TR-82-3064).

TABLE XIII. Lead/lag configurations with Level 1 LOES and Level 2 pilot ratings.

CONF	HOS						LOES			RATING PILOT	
	$1/T_{\theta_2}$	ζ_{sp}	ω_{sp}	$1/T_1$	$1/T_2$	ω_3	ζ_e	ω_e	τ_e	M	W
1A	1.25	0.69	2.2	0.5	2.0	63	0.39	3.14	0	6,4	5
1C	1.25	0.69	2.2	2.0	5.0	16	0.67	3.02	.079	3,5,5	4
2A	1.25	0.70	4.9	2.0	5.0	63	0.46	5.96	0	4,5	4
2B	1.25	0.70	4.9	2.0	5.0	16	0.42	5.67	.059	6,6	4,5
7A	2.5	0.79	7.3	3.3	8.0	63	0.44	8.23	0	4,5	2

- NOTES: 1. HOS from Neal-Smith (AFFDL-TR-70-74); LOES from MCAIR (MDC Rpt A6792)
 2. Equivalent dynamics are Level 1 on MIL-F-8785C limits.
 3. T1 is an added lead; T2 a lag; ω_3 an actuator.

Figures 16 and 17 show the effects of the added lead/lag combinations on these configurations. The net effect is an apparent hump around ω_{sp} characterized in the LOES match by a low equivalent damping ratio (table XIII). The lower-order form has no other way to match a hump in the amplitude plot. Similar effects are seen in the phase angle, figure 17: the humps appear as phase lead (since, for the basic configurations, $\tau_e = 0$). In fact, figure 17 shows that an LOES match over the frequency range of 0.1- 10 rad/sec would produce $-\tau_e < 0$ (if negative time delays were allowed) for Configurations 1A, 2A, and 7A. The small positive τ_e for Configurations 1C and 2B results from the relatively low frequency of the second-order lag (ω_3) for these cases, 16 rad/sec as opposed to 63 rad/sec.

There are two potential methods for dealing with lead/lag systems like those of table XIII; unfortunately, neither is physically very appealing. And in each, there is an underlying question as to the universality of the equivalent systems approach.

a. Redefine Limits on ζ_e

If $\zeta_{e_{min}}$ for Level 1 were increased from 0.35 to 0.50, four configurations in table XIII would fit the requirements (ignoring Configuration 1C, for which none of this discussion is applicable). But restricting unaugmented vehicles as well is not appealing since lower ζ_{sp} is very well supported by flight test data for classical aircraft. The alternative to specify two sets of requirements -- one for unaugmented aircraft and another for augmented aircraft, is especially unattractive, since this is tacit admission that equivalent systems is a misnomer. Additionally, it presents the problem of defining the specific level of augmentation at which the requirements would change over. For example should addition of a simple high-frequency stick filter (whose only major effect is to increase τ_e , figure 18) change the requirement? In fact, the problem with Configurations 1A, 2A, 2B, and 7A is directly traceable from pilot commentary to overabruptness and apparently has nothing to do with damping ratio at all. In figure 16, the high gain at high frequency would indeed be expected to lead to an abrupt response. If for some unforeseen reason a flight control system designer would ever suggest equalization that would produce such humps in the frequency response, use of a frequency-response criterion is suggested. Four of the five configurations of table XIII fit the bandwidth requirement (see figure 64).

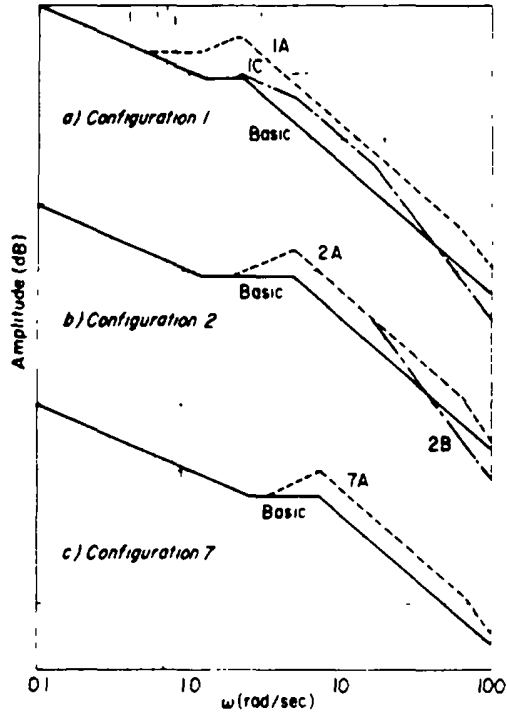

FIGURE 16. Comparison of Bode amplitude plots for basic and augmented configurations of table XIII.

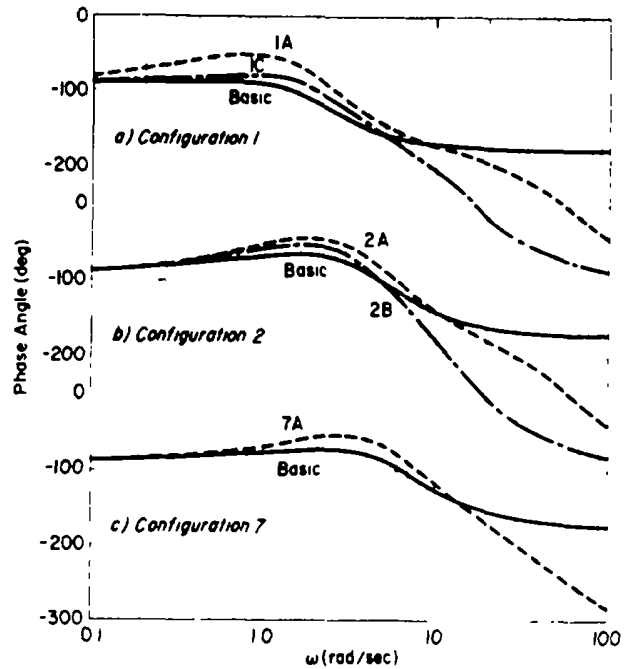

FIGURE 17. Comparison of phase angles for basic and augmented configurations of table XIII.

b. Redefine τ_e

As mentioned above, three of the four low- ζ_e violators of table XIII also have $\tau_e = 0$. As figure 17 suggests, a better LOES fit is obtained for these three cases if τ_e is allowed to be less than zero. Specifically, negative time delays can be found in an LOES match to be as follows:

Configuration 1A $-\tau_e = -0.004$ sec

Configuration 2A $-\tau_e = -0.008$ sec

Configuration 7A $-\tau_e = -0.014$ sec

Physically, unrealizable negative time delay, or time lead, might be considered to represent a HOS which is too abrupt (i.e., if $\tau < 0$, the system responds to an input τ seconds before the input is made or has finite magnitude at zero time) more or less in keeping with the above-noted pilot commentary.

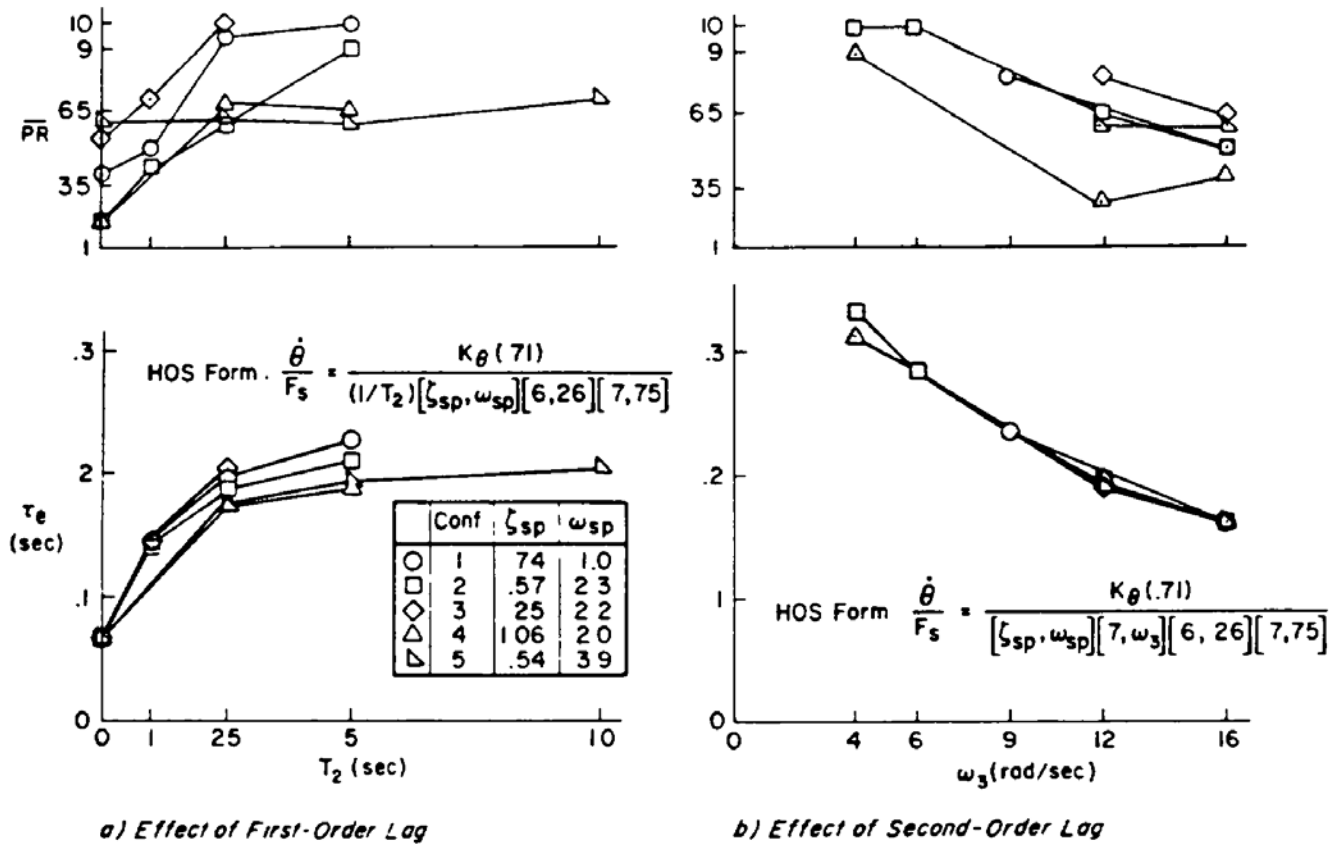

FIGURE 18. Effect of first- and second-order lags on equivalent time delay and pilot rating: LAHOS configurations (AFFDL-TR-78-122).

SIGNIFICANCE OF CAP OR ω_{sp} AND n/α

For conventional aircraft, without direct lift control, the piloting task can be viewed as an inner- and outer-loop, single-controller task as indicated for equivalent-system dynamics in figure 19. This figure points out that $1/T_{\theta_2}$ plays a role in the short-term attitude dynamics and also defines the short-term flight path (or load factor) response. The boundaries in figure 13 are based on a combination of load factor response and the quickness of the pitch attitude response to a control input, i.e., $\omega_{sp}^2/(n/\alpha)$. Some SP interpretations of this parameter are given in the following discussion (In figure 19 note that γ/θ , being the ratio of bare-airframe numerators, incorporates the actual value of $1/T_{\theta_2}$, not necessarily the same as the equivalent system's $1/T_e$ if equalization is employed in feedback or feedforward loops).

a. Control Anticipation Parameter (CAP)

Bihrie in AFFDL-TR-65-198 defines the Control Anticipation Parameter (CAP) as the ratio of initial pitching acceleration to steady-state normal acceleration (the pseudo steady state corresponding to the two-degree-of-freedom short-period approximation).

$$CAP \triangleq \frac{\ddot{\theta}}{\Delta n_{zSS}} \frac{\text{rad/sec}^2}{g} = \frac{\omega_{sp}^2}{\frac{V}{g} \frac{1}{T_{\theta_2}}} \frac{(\text{rad/sec})^2}{\frac{(\text{ft/sec})}{(\text{ft/sec}^2)} (1/\text{sec})} \quad \text{or } g^{-1}\text{sec}^{-2}$$

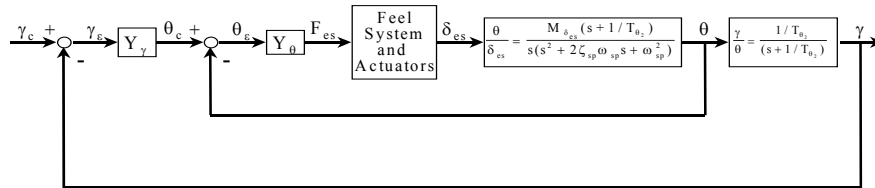

$$\left. \frac{\theta}{F_s} \right|_e + \frac{A_\theta(T_{\theta 2})e^{-\tau_e\theta s}}{(0)|\zeta_e, \omega_e|}$$

$$\left. \frac{\gamma}{F_s} \right|_e + \frac{A_\gamma e^{-\tau_e\gamma s}}{(0)|\zeta_e, \omega_e|}$$

where

$$(a) = (s + a)$$

$$[\zeta, \omega] = [s^2 + 2\zeta\omega s + \omega^2]$$

FIGURE 19. Pilot control of pitch attitude and flight path.

the last expression an approximation holding generally for aircraft with negligible control system dynamics and tail lift effect, as is common, where $(V/g) (1/T_{\theta 2})$ likewise can be approximated by n/α . Because of the time lapse before reaching the steady state, a pilot needs an earlier indication of the response to control inputs - and both the initial and final responses must be neither too sensitive nor too insensitive to the commanded flight-path change.

Note that $\ddot{\theta}_0$ and $\Delta n_{z_{ss}}$ apply to the time response to a step input, for an actual system of any order. If $\ddot{\theta}_0$ is interpreted as the maximum (as discussed later) and there is a nonzero $\Delta n_{z_{ss}}$, then that interpretation has no call to determine any individual equivalent system parameters such as ζ_{sp} .

b. Frequency response interpretation

Equivalently, in the frequency domain the high-frequency gain of pitch acceleration (thought to be important in fine tracking tasks) is given by M_{F_s} and the steady-state gain of normal load factor (thought to be important in gross, or outer-loop, tasks) by $M_{F_s} (n/\alpha) / \omega_{sp}^2$. Hence their ratio is CAP (see figure 20).

c. MIL-F-8785B BIUG interpretation

A closely related analysis in AFFDL-TR-64-72 arrives at $(F_s/n) M_{F_s}$ equal to $\omega_{sp}^2 / (n/\alpha)$ where M_{F_s} is the initial pitch acceleration per pound. This can be seen in the asymptotic n_z/F_s frequency response of figure 20.

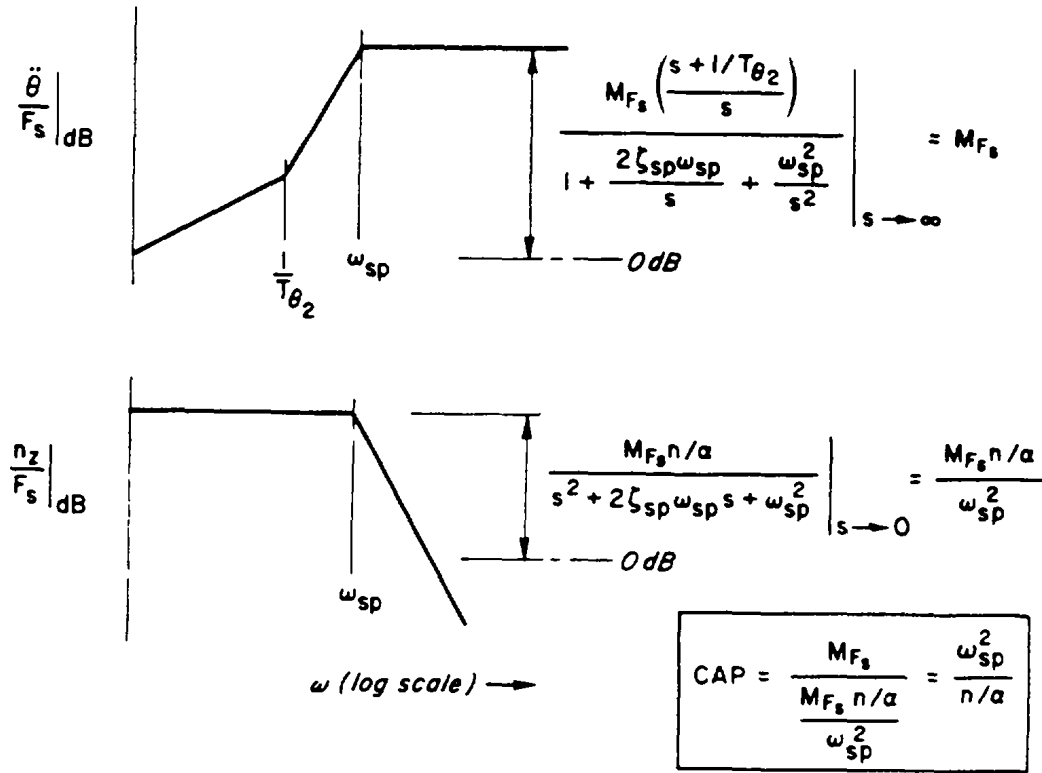

FIGURE 20. Definition of CAP from frequency response asymptotes.

d. Maneuvering stability margin interpretation

Because n/α is proportional to $C_{L\alpha}$ and, roughly, ω_{sp}^2 to $C_{m\alpha}$, $\omega_{sp}^2/(n/\alpha)$ is widely recognized as being related to static margin, $-dC_m/dC_L$. In fact,

$$\frac{n}{\alpha} \doteq \frac{C_{L\alpha} \bar{q} S}{W}$$

and

$$\omega_{sp}^2 \doteq \frac{-\bar{q} S \bar{c}}{I_y} C_{L\alpha} \left(\frac{C_{m\alpha}}{C_{L\alpha}} + \frac{\rho S \bar{c}}{4m} \cdot C_{mq} \right)$$

Therefore,

$$\begin{aligned} \frac{\omega_{sp}^2}{n/\alpha} &\doteq -\bar{c} \cdot \frac{W}{I_y} \left(\frac{C_{m\alpha}}{C_{L\alpha}} + \frac{\rho S \bar{c}}{4(W/S)} \cdot C_{mq} \right) \\ &= h_m \cdot g / (k_y^2 \bar{c}) \end{aligned}$$

where h_m is the maneuver margin expressed as a fraction of \bar{c} (i.e., h_m is the distance, in chord lengths, of the maneuvering neutral point aft of the c.g.), and k_y is the nondimensional pitch radius of gyration. (With C_{mq} neglected, h_m reduces to one common, simple definition of static margin, h_s).

For many aircraft, k_y is about 17 percent of the aircraft length ℓ , so $\omega_{sp}^2/(n/\alpha) = 1100 h_m \bar{c} / \ell^2 \text{ rad}^2/\text{sec}^2$. For the F-4 aircraft, with 64 ft length and 16 ft c , the specified Level 1 value of 0.28 for $\omega_{sp}^2/(n/\alpha)$ reduces to a stick-fixed maneuver margin requirement of 6.5 percent. Thus this requirement is comparable to the earlier 5 percent static margin requirement in U.S. Air Force Specification 1815B/Navy Specification SR-119B.

e. Importance of ω_{sp} and (n/α) individually

Rationally, there should exist lower limits on satisfactory short-period frequency and on normal-acceleration sensitivity to pitch control. This concept is consistent with the in-flight and ground-based simulator experiments of AFWAL-TR-81-3118 and Mooij & van Gool and Wilhelm & Lange in AGARD-CP-333 (Gibson opts as some others have done for bounding $1/T_{\theta_2}$ instead of n/α). Although we have retained the numerical values of MIL-F-8785C, for which there still are few data points, Mooij & van Gool indicate more stringent limits.

POSSIBLE MODIFICATIONS TO CAP

As noted by Bischoff (NADC-81186-60), the control anticipation parameter must be redefined for aircraft with effective time delay since $\ddot{\theta}_o = 0$ in this case. Following DiFranco (AFFDL-TR-66-163), Bischoff defines, on the basis of a unit step stick force input, a more general control anticipation parameter, CAP' , as

$$CAP' \triangleq \frac{\ddot{\theta}_{\max\text{HOS}}}{n_{z_{ss}}}$$

The maximum pitch acceleration, $\ddot{\theta}_{\max\text{HOS}}$, will occur sometime after the force input as shown on figure

21. The parameter CAP' is further extended to the short-period lower-order equivalent system model by, defining

$$CAP'_e \doteq \left(\frac{\omega_{sp}^2}{n/\alpha} \right)_e \cdot \frac{\ddot{\theta}_{\max\text{HOS}}}{\ddot{\theta}_{\text{LOES}_{t=\tau_e}}} \triangleq \frac{\omega_{\text{eff}}^2}{(n/\alpha)_e}$$

where e denotes LOES parameters. In this form, CAP'_e is a hybrid frequency response and time-response parameter easily determined from HOS responses. Bischoff claims "similar results... for the higher order fixed and free low order equivalent system." The $[\omega_{sp}^2/(n/\alpha)]_e$ alone does not give a good approximation to CAP' , because the short-period LOES model will not generally be accurate in the high frequency region which largely determines the initial pitch acceleration history for a step input. Thus $[\omega_{sp}^2/(n/\alpha)]_e$ is modified according to $\ddot{\theta}_{\max}$ as determined from the HOS response (as on figure 21). Generally, this CAP' will vary with the magnitude of the input, because of actuator rate limiting.

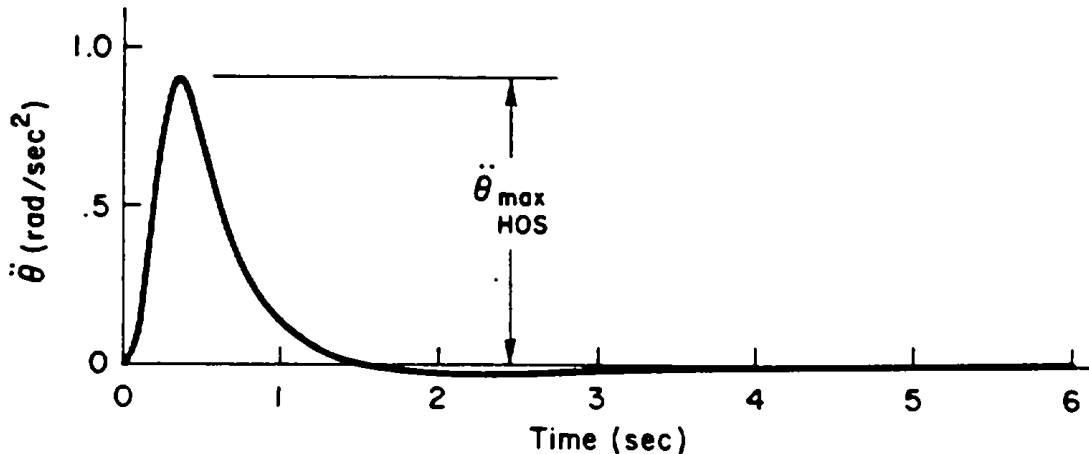

FIGURE 21. Pitch acceleration response to a unit step force input.

NADC-81186-60 accounts for time delay explicitly by defining flying qualities Levels in the $CAP' - \tau$ plane, as shown on figures 22 and 23. The boundaries shown for each flying quality Level were defined by correlations of data from DiFranco (AFFDL-TR-66-63), Neal and Smith (AFFDL-TR-70-74), and the LAHOS study (AFFDL-TR-78-122). These boundaries do seem to correlate the data that Bischoff plotted slightly better than does the present requirement based on CAP (compare to figures 36 and 38), and Bischoff shows excellent correlation between CAP' and CAP'_e for these data. However, the CAP'_e parameter is subject to all the limitations for equivalent systems noted in this requirement. Hence most of the points that do not correlate with CAP or $\omega_{sp} T_{\theta_2}$ will also be missed by CAP'_e and CAP' . The bandwidth specification appears to do a somewhat better job than CAP' .

LEVEL 3

All the suggested short-term pitch response requirements share a common Level 3 floor in recognition of (a) the demonstrated controllability of somewhat unstable airplanes and helicopters from their beginning days and (b) our inability to come up with anything better at this time.

A first-order divergence ($T_2 = 6$ sec) is allowed for the Level 3 pitch attitude dynamics. This is consistent with the Level 3 static stability requirement in 4.4.1. The 6-second limit on instability was derived from in-flight and ground-based simulator studies which have documented the degree of instability that is safely flyable. AFFDL-TR-72-143, for example indicated a Level 2 boundary with T_2 (based on the unstable aperiodic root) of 2.5 seconds in light turbulence and 4.25 seconds in moderate turbulence. Pilot ratings were fairly constant at 5 to 6 until the time to double amplitude was reduced below 6 seconds, when significant deterioration began.

Some margin is allowed in order to account for pilot distraction, design uncertainties, etc. In this region near neutral stability, the root locations generally are extremely sensitive to static margin. On the other hand, Schuler (AFWAL-TR-82-3014) concludes from his ground-based simulations that for light total damping (small value of the other, stable short-term pole) the 6 second limit can be unconservative.

SUPPORTING DATA

Supporting data for both CAP and $\omega_{sp} T_{\theta_2}$ forms of equivalent-system criteria, and for the Level 3 requirements, are presented in the discussion of the $\omega_{sp} T_{\theta_2}$ criteria which follows.

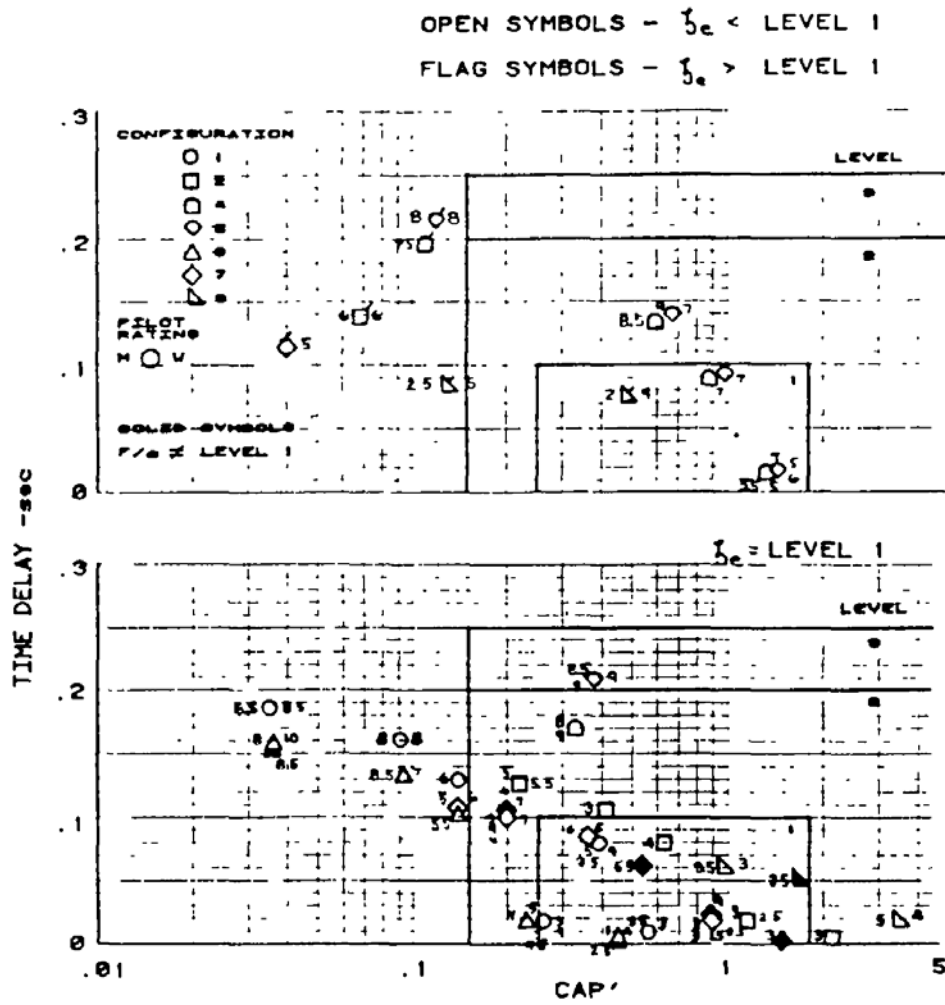

FIGURE 22. Time delay versus CAP' - Neal-Smith data

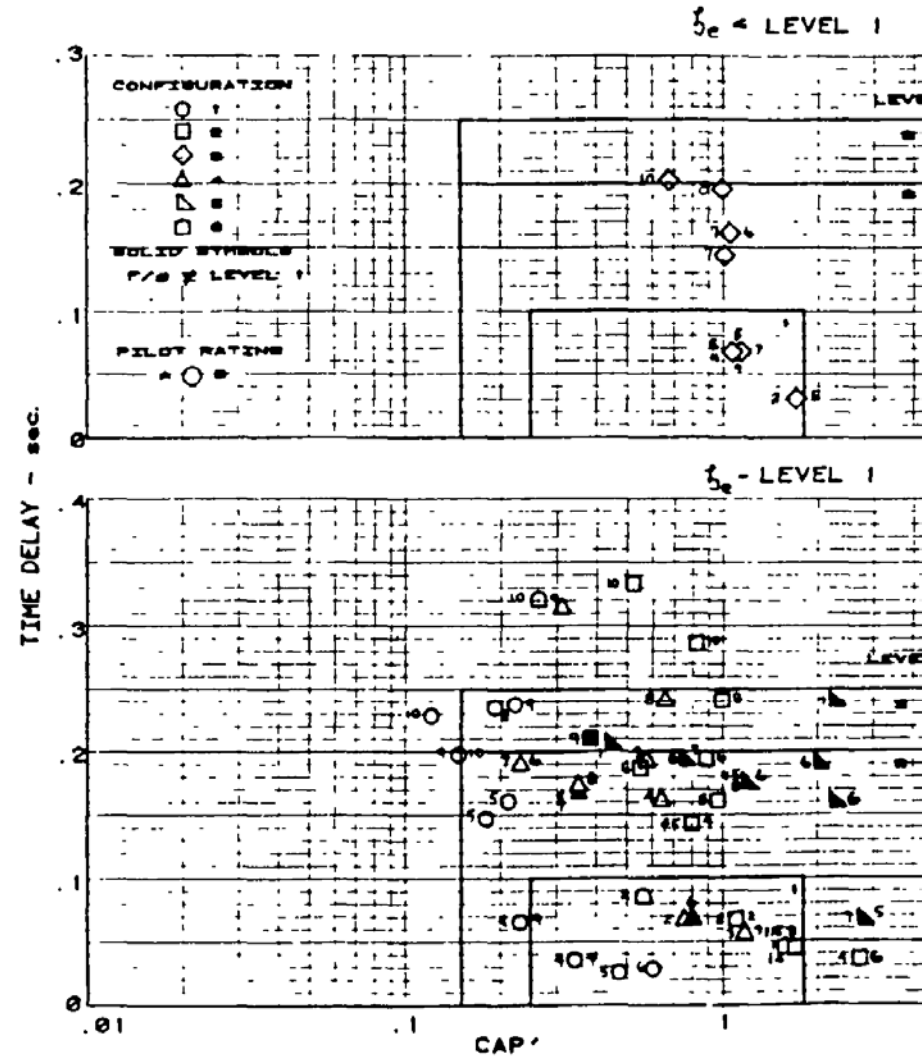

FIGURE 23. Time delay versus CAP' - LAHOS data (from

MIL-STD-1797A
APPENDIX A

(from NADC-81186-60).

NADC-81186-60).

MIL-STD-1797A
APPENDIX A

B. ω_{sp} $T_{\theta 2}$, ζ_{sp} , τ_{θ}

The equivalent pitch rate and normal load factor transfer-function forms for pilot control-deflection or control-force inputs

$$\frac{q(s)}{\delta_{es} \text{ or } F_{es}(s)} = \frac{K_{\theta} s (s + 1/T_{\theta 1}) (s + 1/T_{\theta 2}) e^{-\tau_{\theta} s}}{[s^2 + 2\zeta_p \omega_p s + \omega_p^2] [s^2 + 2\zeta_{sp} \omega_{sp} s + \omega_{sp}^2]}$$

$$\frac{n'_z(s)}{\delta_{es} \text{ or } F_{es}(s)} = \frac{K_n s (s + 1/T_{h1}) e^{-\tau_n s}}{[s^2 + 2\zeta_p \omega_p s + \omega_p^2] [s^2 + 2\zeta_{sp} \omega_{sp} s + \omega_{sp}^2]}$$

simultaneously shall be fit to the corresponding actual response of the aircraft over a frequency range of 0.1 to 10 radians per second. The parameter n'_z is normal acceleration at the instantaneous center of rotation for pilot pitch control inputs. Corresponding matches shall be made for pilot control-deflection inputs. The requirements of figure 24 apply to the equivalent-system parameters determined from the best match for force inputs, and also for deflection inputs; the procuring activity will be the judge of the adequacy of the matches.

For Level 3, T_2 , the time to double amplitude based on the value of the unstable root shall be no less than 6 seconds. In the presence of any other Level 3 flying qualities, ζ_{sp} shall be at least 0.05 unless flight safety is otherwise demonstrated to the satisfaction of the procuring activity. T_2 applies to the value of an unstable root: $T_2 = -(\ln 2)/\lambda$ where λ , is the value of the unstable root.

Requirements on the equivalent pitch time delay, τ_{θ} , apply to the value for $\theta(s)/\delta_{es}(s)$ for a deflection control system (pilot controller deflection commands the control effectors) and to $\theta(s)/F_{es}(s)$ for a force control system (pilot controller force commands the control effectors):

Level	Allowable Delay
1	0.10 sec
2	0.20
3	0.25

If an adequate match cannot be found, the contractor with the concurrence of the procuring activity shall substitute an alternative requirement.

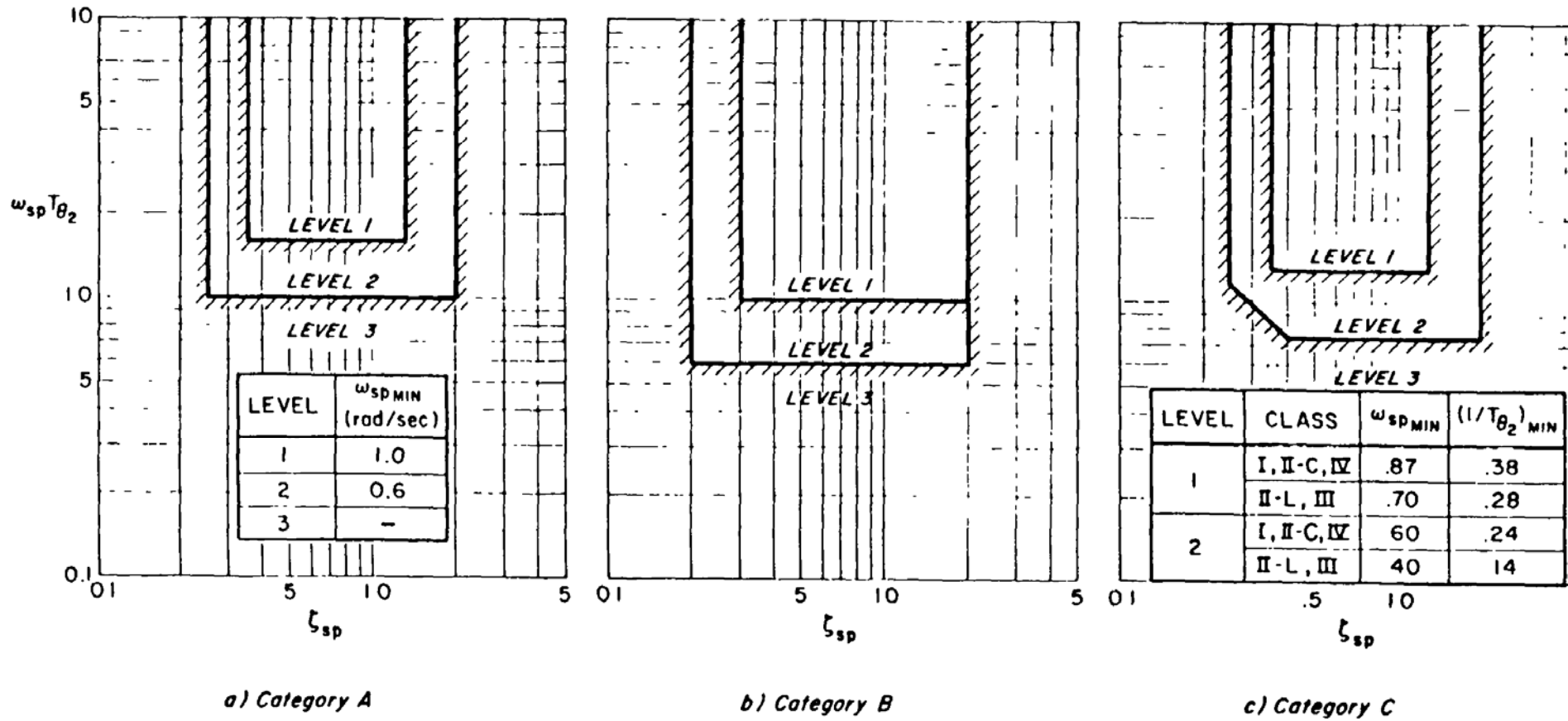

FIGURE 24. Requirements for short-term pitch response to pitch controller ($\omega_{sp}T_{\theta_2}$ vs ζ_{sp}).

MIL-STD-1797A
APPENDIX A

Equivalent systems are discussed above, in connection with the CAP. Much of that discussion was based upon the premise that the normal acceleration response to attitude changes is a primary factor affecting the pilot's perception of the minimum allowable ω_{sp} . It is, of course, also true that the pitch attitude response to pitch control inputs is in itself of great importance. Whether the appropriate correlating parameter is n/α or $1/T_{\theta_2}$ unresolved: data that are correlatable with $1/T_{\theta_2}$ will generally also correlate with n/α . This issue was studied in AIAA Paper 69-898, where it was observed debatably that the product $\omega_{sp} T_{\theta_2}$ provided a slightly better correlation than CAP. Physically, for the classical case $\omega_{sp} T_{\theta_2}$ represents the lag in phase (at ω_{sp}) or time between aircraft responses in pitch attitude and path. If $1/T_{\theta_2}$ is too large with respect to ω_{sp} or the closed-loop pitch bandwidth, the path and attitude responses may not be separated enough to give a pilot the additional cues he needs in order to control the outer, slower path loop. The aircraft responses in attitude and flight path to elevator deflection occur almost simultaneously, resulting in abrupt heave responses to the pitch controller. This produces pilot comments such as "trim hard to find" and "pilot effort produces oscillations." However, too great a frequency separation creates a large hump in $|\dot{\theta}/\delta|$, manifest as a large pitch rate overshoot, or bobbling tendency in closed-loop tracking. We see that $\omega_{sp} T_{\theta_2}$, in combination with ζ_{sp} , also defines the shape of the attitude frequency response: $\log(\omega_{sp} T_{\theta_2})$ is the difference in frequency, on the usual logarithmic scale, between ω_{sp} and T_{θ_2} . Desirable values yield a K/s shape of θ/δ in the frequency range of primary interest (see AIAA Paper 69-898). A useful criterion, therefore, is the product $\omega_{sp} T_{\theta_2}$.

SUPPORTING DATA

The data base consists of airplanes with classical flying qualities as well as highly augmented airplanes which are treated in this section by reduction to lower-order equivalent systems. The supporting data for classical airplanes and highly augmented airplanes are presented separately in the following two subsections, which are further subdivided according to the Flight Phase Category of the data. In each instance, both the CAP and the $\omega_{sp} T_{\theta_2}$ forms of equivalent systems criteria are discussed. Lastly, the Level 3 substantiation is presented.

Supporting data--classical airplanes

Most of the available data are for Category A Flight Phases only. A small amount of Category C data is available, while data for Category B are extremely sparse. There is a considerable amount of existing data which do not support the boundaries in figures 13 and 14 (see AFFDL-TR-69-72). However, a close review of the data reveals that most of the scatter was due to secondary effects. For example, in some cases the stick force per g (F_s/n) was outside the Level 1 limits. In other cases the tests were performed with an extremely low load factor limit ($n_z < 2.0$ g), or with the shore-period frequency near a wing structural mode. There is evidence in the references that in these cases the extraneous factors may be influencing pilot ratings.

A careful review of AFFDL-TR-66-63, FDL-TDR-64-60, WADC-TR-55-299, WADC-TR-57-719, AFFDL-TR-68-91, NASA-TN-D-779, NASA-TM-X-1584, NASA-TN-D-3971, WADC-TR-54-594, AFFDL-TR-69-3, Boeing Report D6-10725, Cornell Report TB-1444-F-1, and Princeton University Report 777 was undertaken to cull out inappropriate data. Those reports which were complete enough to allow a thorough analysis of the test conditions and results were reviewed in detail. Others were considered to raise too many questions to be analyzed with confidence. (This is not meant to imply that some of the reports are invalid, but that they were not complete enough to gain sufficient insight into the causes for expected or unexpected pilot ratings.)

In particular, valid and usable reports were those which contained at least the following: 1) characteristics of short-period mode(s); 2) description of aircraft actuators, feel system, etc.; 3) description of maneuvers;

MIL-STD-1797A
APPENDIX A

4) flight conditions; 5) pilot opinion rating scales used; and 6) pilot comments or discussion of pilot comments. The last factor especially reduced the number of reports retained for analysis. Pilots' descriptions of motions, responses, flight conditions, and control forces were considered essential to justify any pilot ratings which were inconsistent with other test data or with expectations.

WADC-TR-55-299, WADC-TR-57-719, NASA-TN-D-779, WADC-TR-54-594, Boeing Report D6-10725, and Princeton University Report 777 do not contain sufficient pilot commentary, if any, to be useful in the above context. In addition, high Mach number data in NASA-TM-X-1584 were not used because pilots considered the attitude display of the aircraft (an XB-70) to be inadequate when operating at Mach 3. Low- n/α tests of AFFDL-TR-66-163 ($n/\alpha = 16.9$ g/rad) were subject to a buffet-onset load factor limit of $n_z = 2$ g--low for evaluating a fighter-type aircraft; was also noted (AFFDL-TR-66-163, page 41) that:

Airplane sensitivity was more erratic and difficult to control when the structural modes of the airplane were excited. The primary mode excited was wing bending, which occurred at frequencies between 17 and 21 rad/sec (2.7 to 3.3 cps). These bending frequencies were observed in the oscillograph record of a wing tip mounted accelerometer and are a function of the fuel remaining in the tip tanks. Both pilots commented on the varying degree of structural excitation that occurred when the airplane undamped frequencies varied from approximately 8 to 11.5 rad/sec (approximately half the structural frequencies). The erratic nature of the pilot ratings and pilot-selected stick forces in this region are also understandable. The pilots were obviously correcting and interpreting sensitivity due to structural factors as well as the inherent airplane sensitivity.

However, Chalk has stated (personal communication) that the evaluation pilots generally seemed to be able to discount that effect to give valid ratings.

Based on the evidence, some data of AFFDL-TR-66-163, AFFDL-TR-70-74, and AFFDL-TR-69-3 (which are T-33-based experiments) with $\omega_{sp} > 8$ rad/sec are presented here. We note that all three reports show a rating deterioration at high ω_{sp} that tends to support the given upper bound Ratings data from Cornell Report TB-1444-F-1 (taken in a B-26, simulating a fighter configuration) showed greater scatter and overall better (lower) ratings than any of the other reports. This led to an evaluation of the reference, and to the conclusion that the tasks of TB-1444-F-1 were not sufficiently demanding to provide a good basis for evaluation of closed-loop handling qualities. Hence the data were not used.

In summary, AFFDL-TR-66-163, AFFDL-TR-70-74, AFFDL-TR-68-91, and AFFDL-TR-69-3 provided good short-period data for Category A; NASA-TM-X-1584, NASA-CR-159236, and AFWAL-TR-83-3015 contain usable Category B data; FDL-TDR-64-60 and NASA-TN-D-3971 contained Category C information; for large aircraft AFFDL-TR-72-41, NASA-CR-159236, AFWAL-TR-81-3118, AFWAL-TR-83-3015, and AGARD-CP-333 furnish additional insight.

Category A

1. $\omega_{sp}^2/(n/\alpha)$ criterion

Figure 25 shows the short-period frequency boundaries for the Category A Flight Phases. The applicable data (with Level 1 F_S/n) from AFFDL-TR-66-63, AFFDL-TR-68-91, and AFFDL-TR-69-3 are compared with the boundaries. These data represent 52 separate $\omega_{sp} - n/\alpha$ combinations flown and rated b), six pilots. Eight configurations which fell within the Level 1 boundaries were rated Level 2 or worse. The boundaries correctly predicted pilot ratings about 80 percent of the time--an adequate success rate given the variability of flight tests and pilot ratings. Note that most of the violations occur at large n/α (as at high speed). The Level 1 boundaries are slightly more lax than the best fit to the data presented.

MIL-STD-1797A
APPENDIX A

The data in figure 25 represent those cases for which ω_{sp} and F_s/n were within the present Level 1 boundaries. Therefore, the ratings shown can be assumed to be due solely to short-period frequency and n/α influences. For some experiments it could be argued that even Level 2 F_s/n should be plotted, since the pilots were allowed to select the optimum value. We have taken a somewhat conservative approach by eliminating these data. Our reasoning was that Levels 2 and 3 are boundaries for an off-nominal or failed state, and that pilots will not have a chance to optimize F_s/n after a failure. It should be noted that when Level 2 values of F_s/n are selected by pilots it is usually to account for a basic flying quality deficiency. For example, a pilot would desire a very low F_s/n after a failure which results in a statically unstable airframe, requiring pulse-like control inputs. The data generally support the requirements, although the Level 1 lower boundary may be somewhat low.

The baseline cases of AFFDL-TR-70-74, discussed under Augmented aircraft, also support the Category A boundaries.

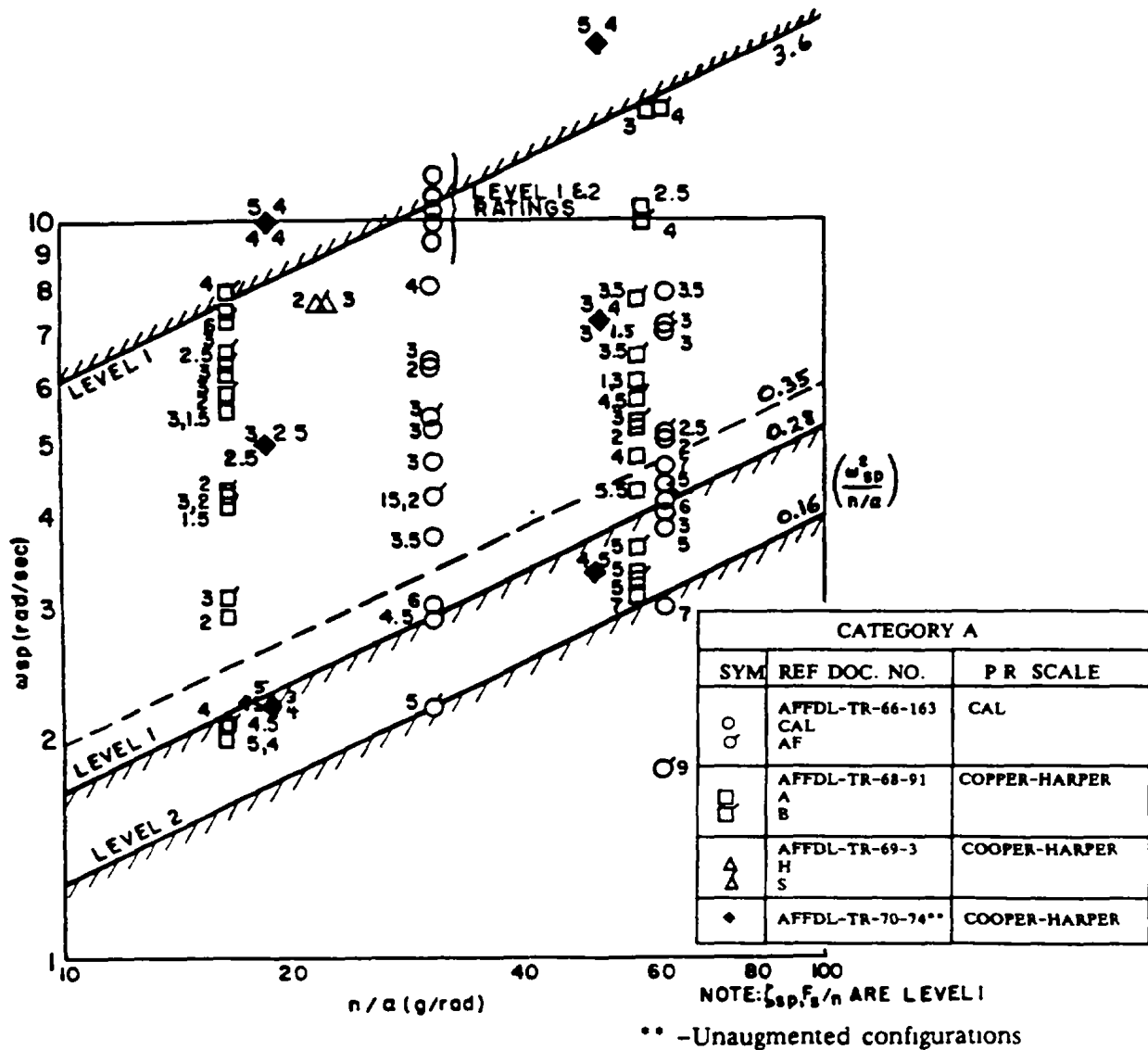

FIGURE 25. Comparison of pilot ratings with category A short-period frequency requirements.

MIL-STD-1797A
APPENDIX A

Short-period damping, boundaries are shown on figure 16. Since this criterion presents ζ_{sp} as an independent parameter, it has been plotted directly against pilot rating. The other variables (ω_{sp} , n/α and F_g/n) are Level 1 values. The resulting data (48 individual ratings) show definite trends in correlation with the boundaries, although there is a shortage of data points in the Level 2 and 3 areas. However, several points for which damping is good ($\zeta_{sp} = 0.67-0.74$) are rated Level 2 to 3. The low-damping data from AFFDL-TR-66-63 suggest that the ζ_{sp} lower limits could be reduced. Seven ratings are worse (higher in value) than predicted, all occurring within the Level 1 boundaries; a few are better than predicted. Any possible interdependence between ζ_{sp} and $\omega_{sp}^2/(n/\alpha)$ can be taken into account by replotting the criterion boundaries on a grid of ζ_{sp} vs. $\omega_{sp}^2/(n/\alpha)$ as in figure 27.

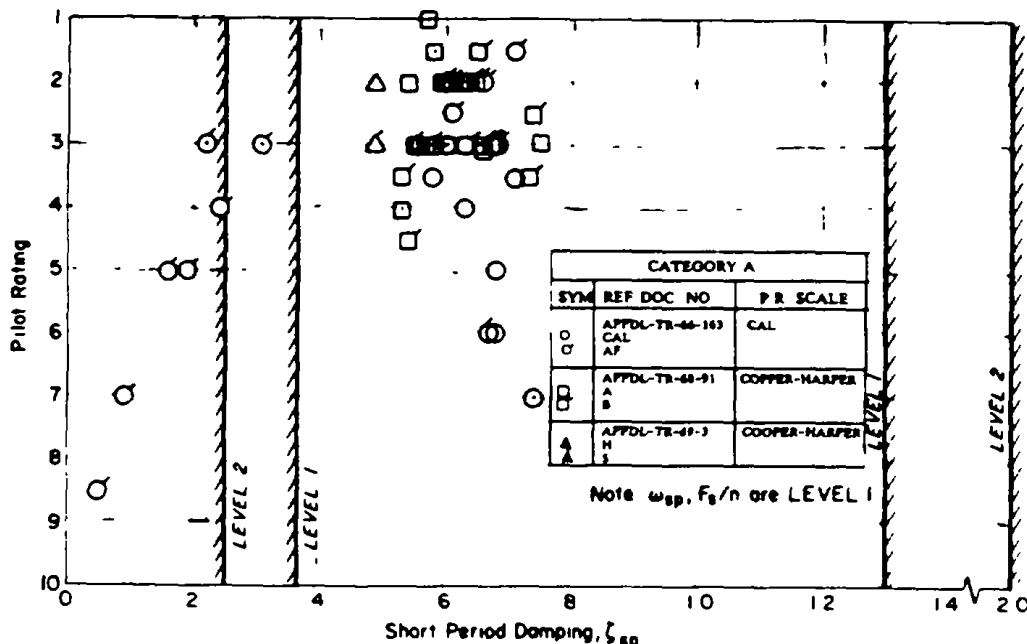

FIGURE 26. Comparison of pilot ratings with Category A short-period damping requirements.

The authors of AFFDL-TR-69-72 also noted that ζ_{sp} lower limits were too restrictive. However, the data-supported limits do not account for turbulence (it was minimal); therefore the MIL-F-8785B limits were chosen somewhat higher.

The upper $\omega_{sp}^2/(n/\alpha)$ limits of MIL-F-8785C are difficult to confirm based on the figure 27 plot because the validity of the high-frequency ($\omega_{sp} > 8$ rad/sec) data has been questioned, as noted above. Some of the data may be usable, however, since the structural bending mode was reported to be most pronounced at low speed with a high fuel load. For this Handbook we have used some of the basic high-frequency data (unaugmented configurations). The upper boundary on $\omega_{sp}^2/(n/\alpha)$ has been retained.

For the C-5A airplane, AFWAL-TR-83-3015 presents (a) data showing generally Level 2 & 3 $\omega_{sp}^2/(n/\alpha)$, figure 28, for two Category A tasks, terrain following and refueling – receiver, worse than Level 3 according to MIL-F-8785B/C at aft cg and (b) a letter from the 60th Military Airlift Wing (MAC) attesting that “Most C-5A pilots find that the manual flying characteristics of the C-5A are excellent.” Because some Class III aircraft may be much smaller than the C-5A we do not wish to reduce the Category A requirement generally for Class III aircraft. For very large aircraft, however, similar size or task artifacts may affect tolerable levels of dynamic stability.

MIL-STD-1797A
APPENDIX A

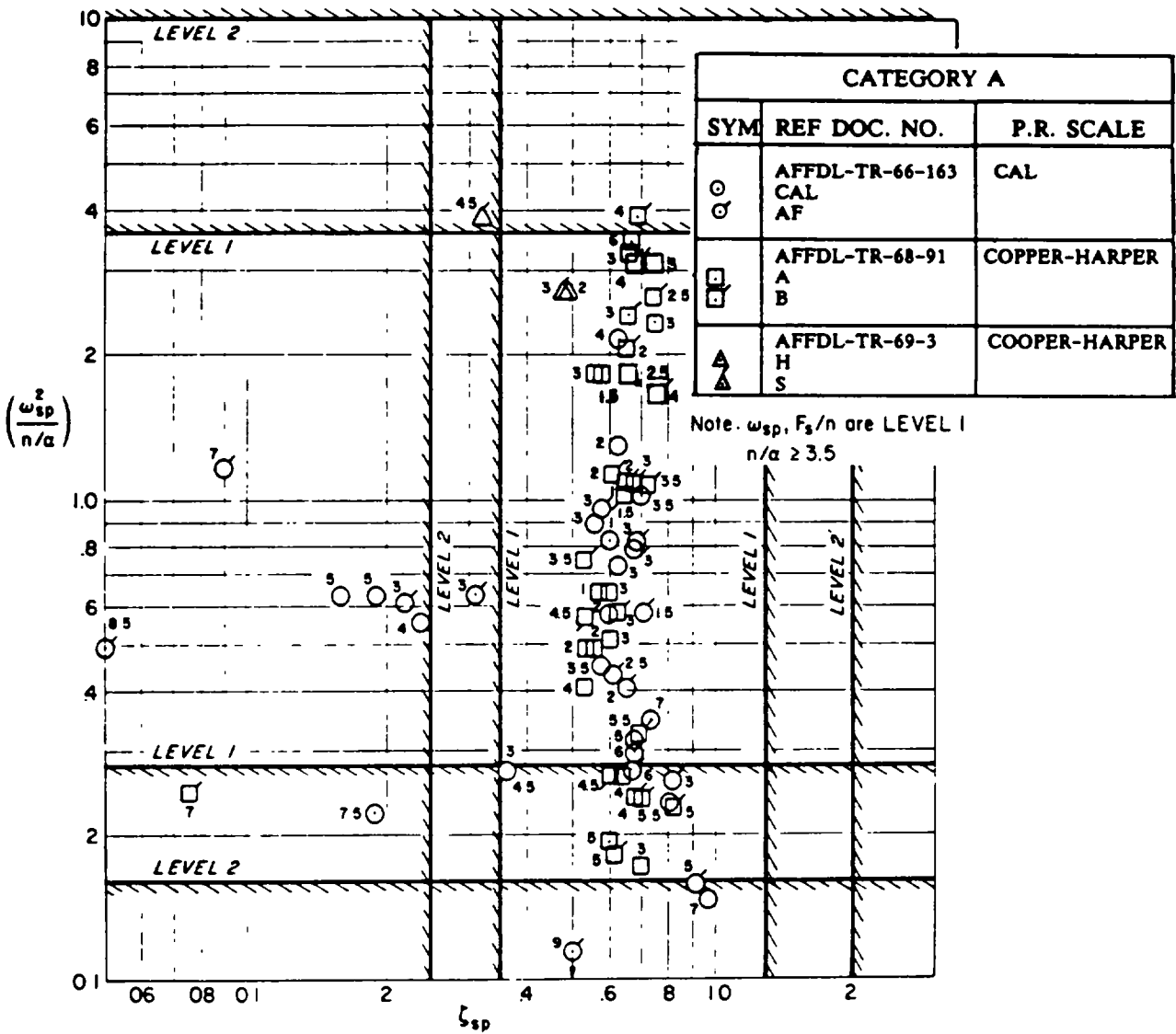

FIGURE 27. Comparison of pilot ratings with Category A short-period frequency and damping ratio requirements.

2. $\omega_{sp}T_{\theta_2}$ vs. ζ_{sp} criterion

Figure 29 shows the data used to support the requirements based on $\omega_{sp}T_{\theta_2}$ and ζ_{sp} . The damping limits are not supported by the pilot ratings but are consistent with the reasoning shown in the preceding discussion. The absolute lower limits on ω_{sp} utilized in the $\omega_{sp}^2/(n/a)$ criterion have been retained in the $\omega_{sp}T_{\theta_2}$ vs. ζ_{sp} requirement for the lack of any better data. They are presented in a table in figure 24a.

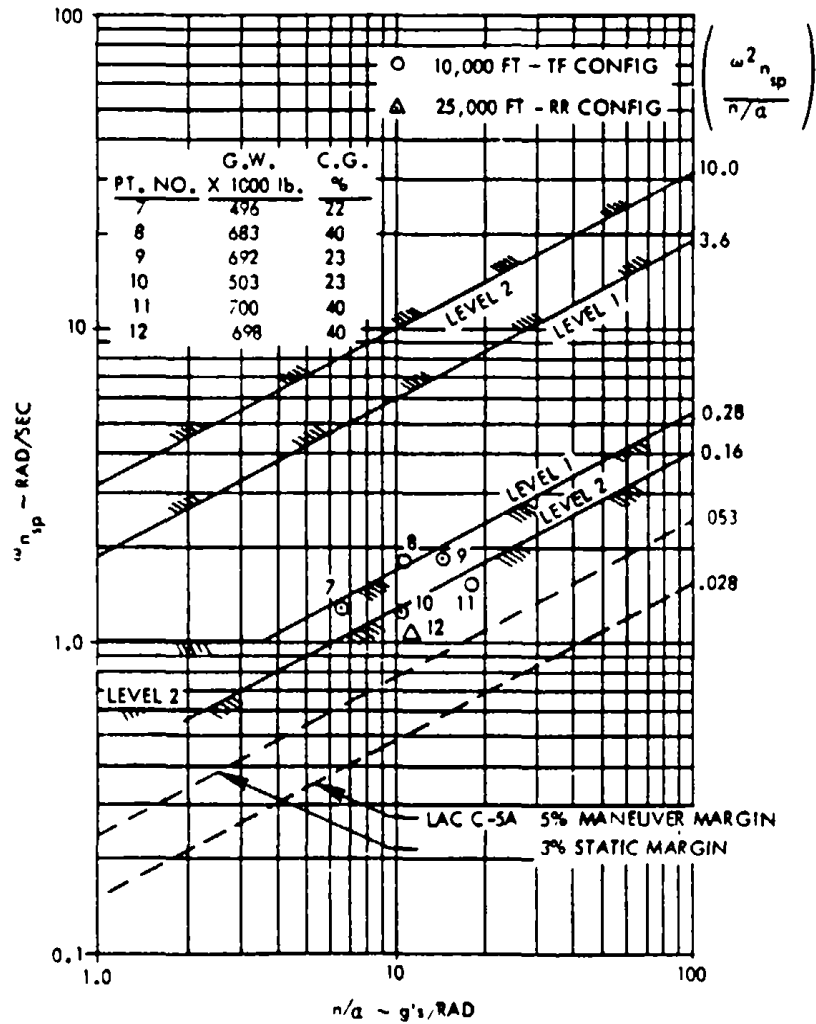

FIGURE 28. Category A C-5A flight test data.

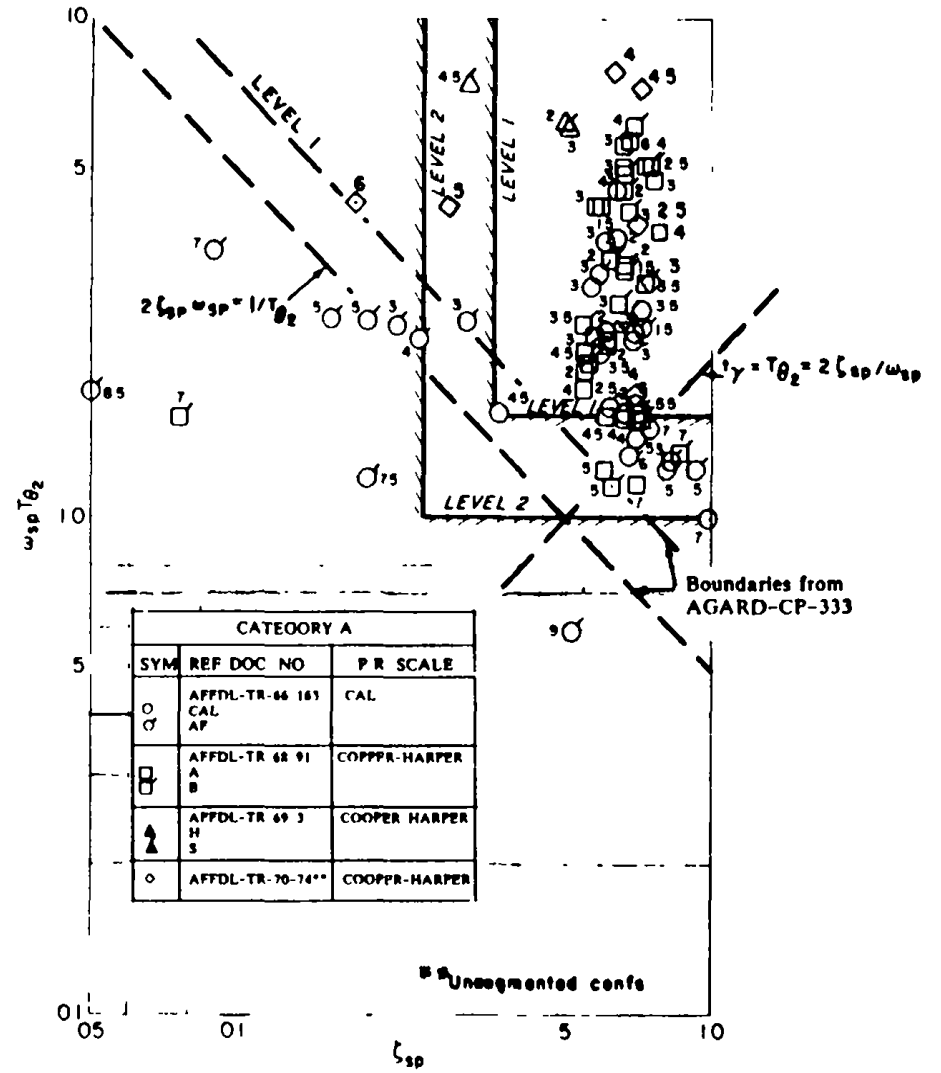

FIGURE 29. Alternate Category A flying qualities requirements for short-period pitch response.

MIL-STD-1797A
APPENDIX A

MIL-STD-1797A
APPENDIX A

Two criteria proposed by Gibson in AGARD-CP-333 (section F), $2\zeta_{sp}\omega_{sp} > 1/T_{\theta_2}$ and $T_{\theta_2} > t_\gamma$, the asymptotic time lag in flight-path response, are seen in figure 29 to correlate with the data as well as $\omega_{sp}T_{\theta_2}$ does.

More work needs to be done to define the upper limits on $\omega_{sp}T_{\theta_2}$ for Category A. In AGARD-CP-333, Gibson indicates good and poor regions of his variables “dropback/q” = $T_{\theta_2} - 2\zeta_{sp}/\omega_{sp}$ and q_{max}/q , a function of $\omega_{sp}T_{\theta_2}$ and ζ_{sp} . ICAS-86-5.3.4 discusses both upper and lower limits of $\omega_{sp}T_{\theta_2}$, outlined in Section F, related also to the response parameter of time to the pitch rate peak. All are task dependent and most vary with T_{θ_2} .

Category B

1. $\omega_{sp}^2/(n/\alpha)$ criterion

Applicable pilot ratings from NASA-TM-X-1584 (XB-70) are compared with the ω_{sp} limits in figure 30 and with the ζ_{sp} boundaries in figure 31. The data do not conflict with the boundaries.

We adopt NASA-CR-159236's recommendation to relax the $\omega_{sp}^2/(n/\alpha)$ floors based on Concorde cruise and C-5A data. AFWAL-TR-83-3015's L-1011 data also tend to support such a change, considering the L-1011 to have reasonably good flying qualities. The data are presented in figures 32 through 35.

2. $\omega_{sp} T_{\theta_2}$ vs. ζ_{sp} criterion

Since there are insufficient data to propose boundaries, the Category B limits have been made compatible with the Category A and C limits, so $\omega_{sp} T_{\theta_2} = 1.0$ for Level 1 and $\omega_{sp} T_{\theta_2} = 0.58$ for Level 2. Figure 36 illustrates the criterion, and compares the NASA-TM-X-1584 data.

Category C

1. $\omega_{sp}^2/(n/\alpha)$ criterion

The Category C flight tests data of FDL-TDR-64-60 and NASA-TN-D-3971 (T-33 and B-367-80, respectively) and NADC-80157-60 (Navion) are compared with the short-period frequency requirements in figure 37 and damping requirements in figure 38.

The frequency data fit the boundaries very well, with a success rate of about 81 percent. This is comparable to the 80 percent for the Category A data, but there are far fewer Category C ratings, over a much smaller range of n/α . However, ratings better than 3.5 seem to require $\omega_{sp}^2/(n/\alpha)$ above the Category A Level 1 boundary, which is considerably higher than the corresponding Category C boundary. Damping predictions are worse, 73 percent--identical to that for Category A. The data support reduction in the minimum ζ_{sp} for all Levels, similar to those suggested by the Category A data. However, as for the Category A data, these tests were conducted in minimal turbulence, so the MIL-F-8785C damping ratio limits have been retained.

MIL-STD-1797A
APPENDIX A

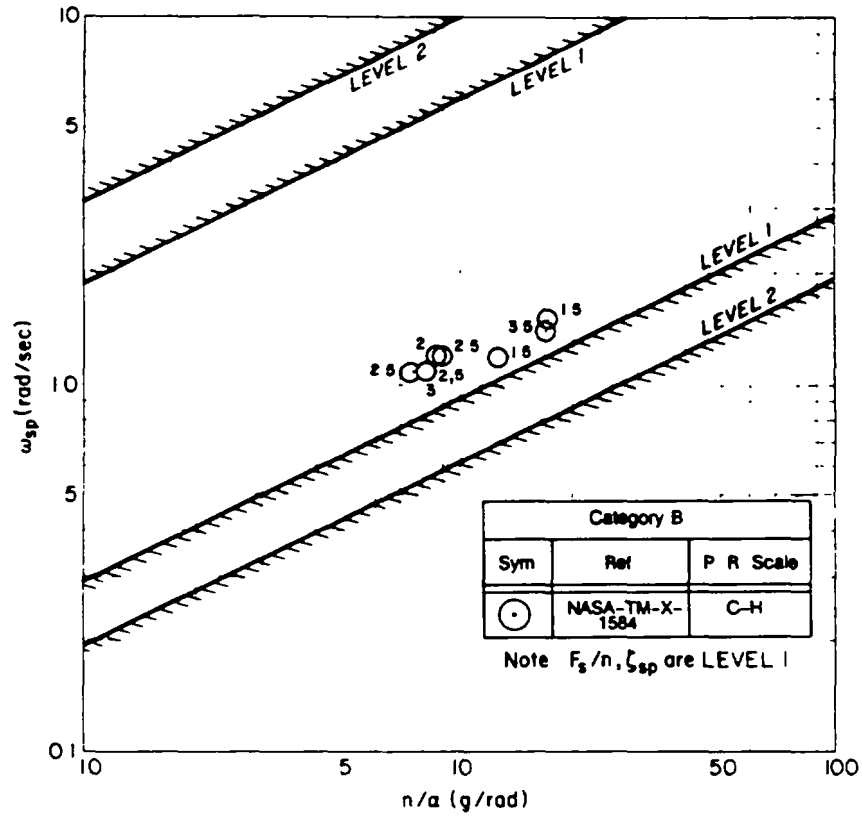

FIGURE 30. Comparison of pilot ratings with Category B short-period frequency requirements.

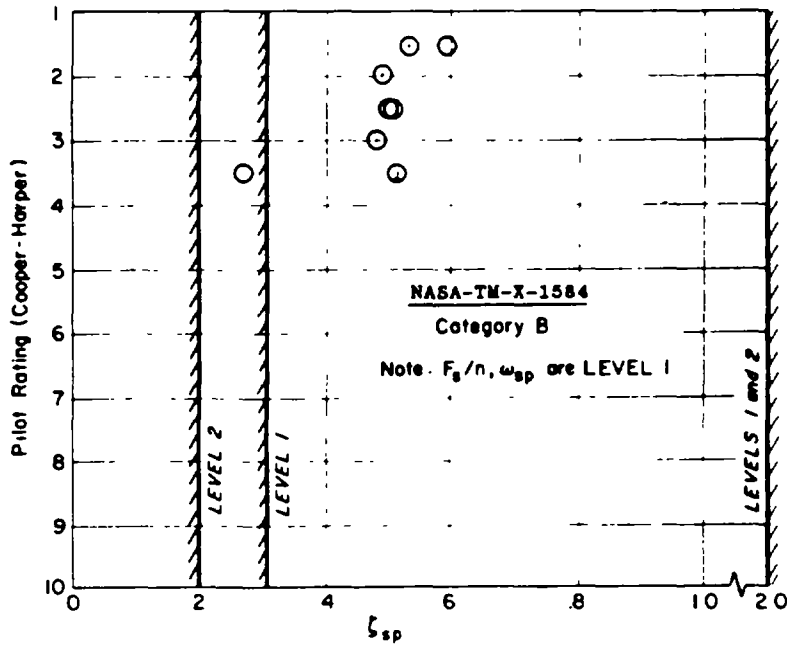

FIGURE 31. Comparison of pilot ratings with Category B short-period damping requirements.

MIL-STD-1797A
APPENDIX A

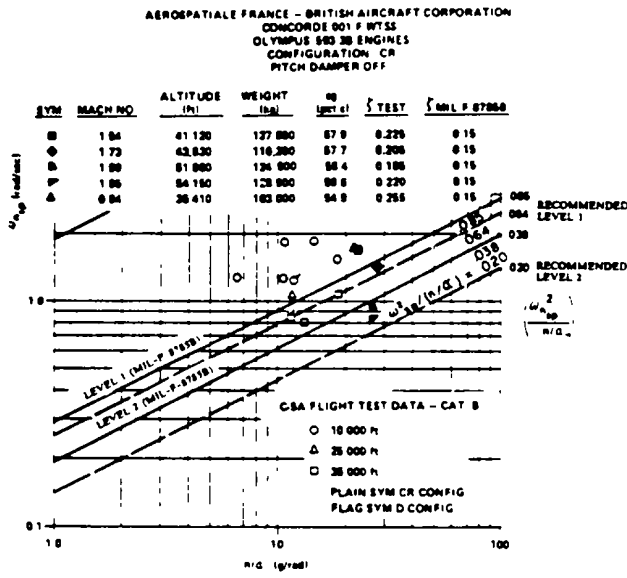

FIGURE 32. Category B short-period characteristics.

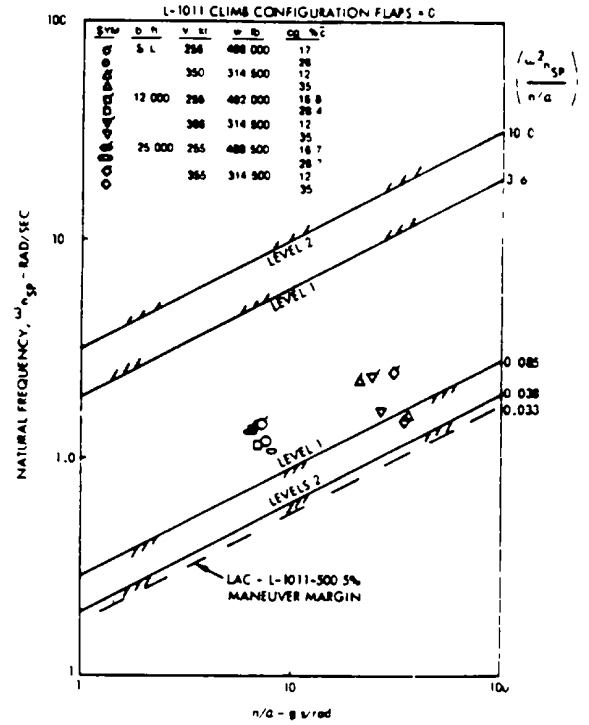

FIGURE 33. L-1011 climb short-period characteristics.

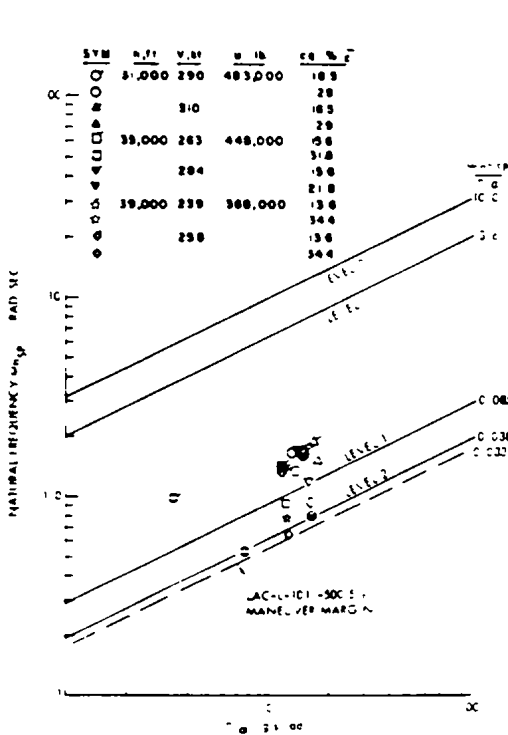

FIGURE 34. L-1011 cruise short-period characteristics (AFWAL-TR-

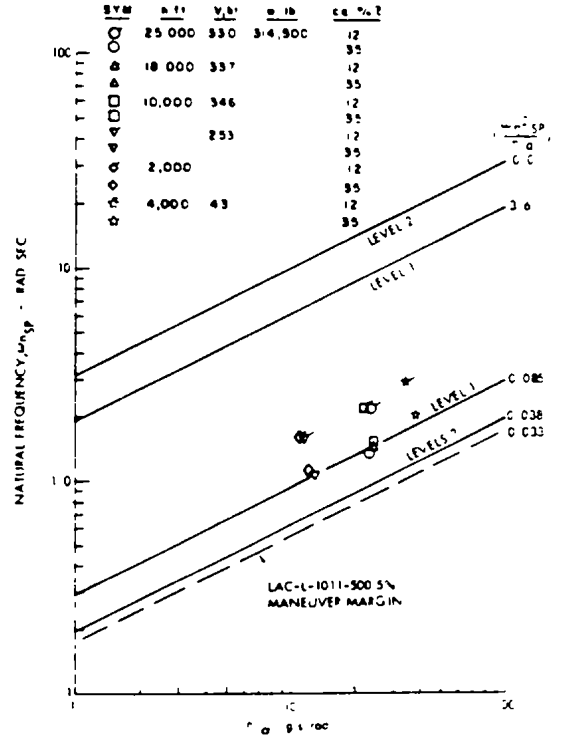

FIGURE 35. L-1011 descent short-period characteristics (AFWAL-TR-83-

MIL-STD-1797A
APPENDIX A

83-3015).

3015).

MIL-STD-1797A
APPENDIX A

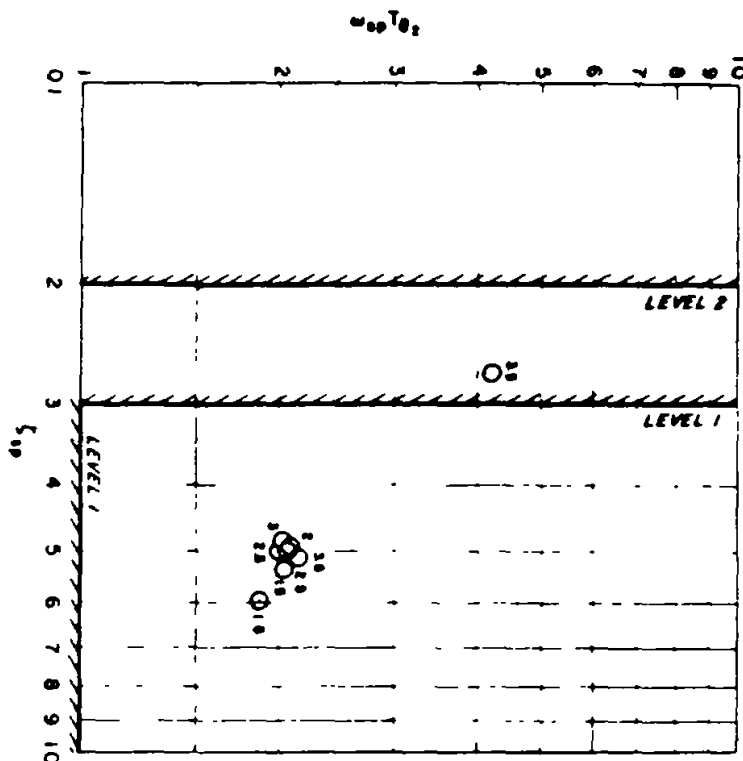

FIGURE 36. Alternative Category B short-period flying qualities requirements (NASA-TM-X-1584 data, Level 1 F_s/n).

Ratings of AFFDL-TR-78-122's baseline configurations, included under Augmented aircraft, support these Category C $\omega_{sp}^2/(n/\alpha)$ boundaries.

Recommendations to relax the Category C ω_{sp} boundary for large airplanes, as for example in AFWAL-TR-83-3015, have not been adopted for reasons expressed well by van Gool and Mooij in private correspondence:

We realize that one of the reasons for changing Class III requirements is that the currently flying large aircraft supposedly have Level 1 handling qualities while not complying with many of the current requirements. Widening the boundaries may be only part of the solution though. In our opinion the fact that the handling qualities of these aircraft are satisfactory is mainly the result of an adapted piloting technique. The pilots have learned to cope with low short period frequency, low acceleration sensitivity and large time delays by avoiding to get into the control loop. Pilots flying aircraft like B 747, DC 10 and C-5 will tell you that, e.g., the landing flare is an open loop maneuver. We assume that the fact that time delays as high as 0.4 s did not affect the pilot ratings in the Lockheed study was caused by the use of an open-loop landing technique.

For military operations this open-loop technique appears inadequate.

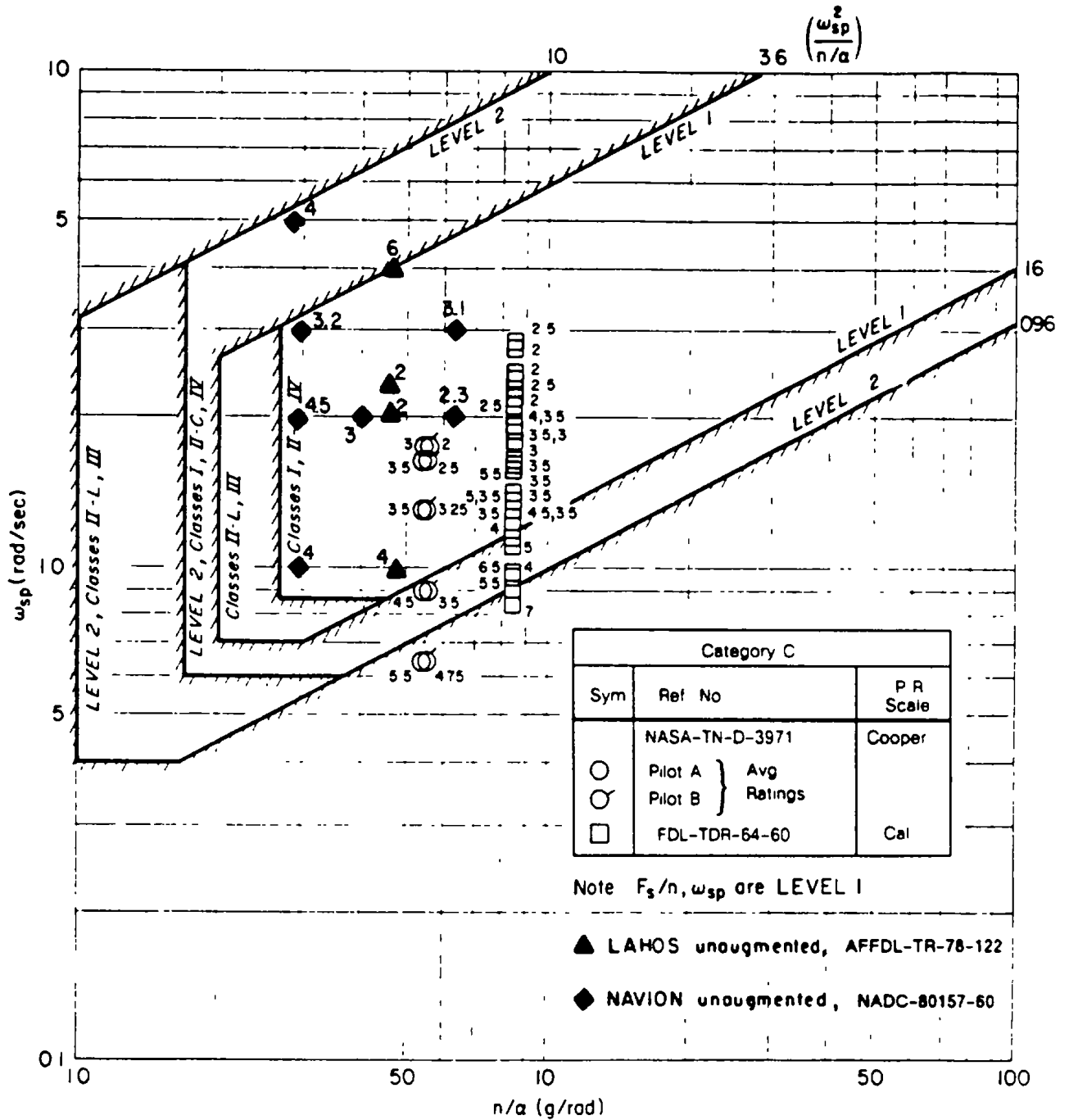

FIGURE 37. Comparison of pilot ratings with Category C short-period frequency requirements.

Supporting data--large aircraft (Classes II and III)

There have been frequent suggestions by manufacturers of large aircraft that the Level 1 lower requirements on ω_{sp} vs. n/α should be lowered in the landing approach. Calspan, in NASA-CR-159236, did not recommend this relaxation because data in the BIUG, AFFDL-TR-69-72, and in Calspan's proposal to modify MIL-F-8785B, AFFDL-TR-72-41, substantiate the original boundary quite well. Informal

MIL-STD-1797A
APPENDIX A

discussions with pilots of large aircraft indicate that current large airplanes possess generally comfortable bandwidth for routine use. However, when the task difficulty increases due to weather conditions, for example, hard landings and go-arounds are common. In view of the very demanding landing conditions being imposed on large military aircraft such as the YC-14, YC-15 and C-17, relaxation of the requirement seems imprudent until more substantiating data become available. Indeed, although AFWAL-TR-83-3015 indicates that somewhat lower values can be satisfactory, AFWAL-TR-81-3118 and Mooij & van Gool in AGARD-CP-333 indicate that the lower Level 1 boundary might be raised.

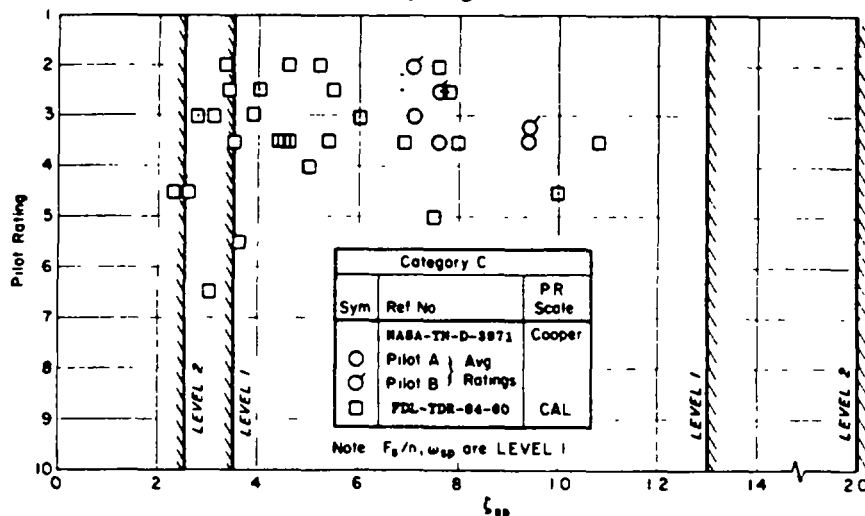

FIGURE 38. Comparison of pilot ratings with Category C short-period damping requirements.

However, a body of data supports relaxation of the Level 2 & 3 requirement. Consistent with allowing a divergence in the Level 3 case, that floor has been removed here. A lower Level 2 floor of $\omega_{sp}^2 / (n/\alpha) = 0.05$ suggested for transport aircraft in NASA-CR-159236 has been adopted. The data in figures 39 and 40 tend to support this new bound.

For lower-bandwidth tasks, the recommended maximum time delays seem too strict. WADC-TR-56-258 relates AFFDL-TR-78-122, AFFDL-TR-70-74, and AFFDL-TR-68-90 data according to "The closed-loop pitch attitude bandwidths which pilots were generally believed to be requiring in these experiments." The effective time-delay boundaries are shown to correspond to constant phase lags at those bandwidth frequencies (figure 41) [Although this effective time delay comes from a time history (see "C. Transient Peak Ratio,..."), equivalent time delay τ_e would follow the same trend.] Considering that for AFWAL-TR-81-3118's million-pound transport "The landing approach and simulated touchdown task ... with a large, slow-responding aircraft can be considered as having the same bandwidth requirements (1.5 rad/sec) as the fighter up-and-away and low altitude waveoff task of AFFDL-TR-68-90," the trend is verified. However, the data are too sparse to be definitive. Other data, cited in AFWAL-TR-83-3015, suggest even less stringent limits. And for emergencies, an experimental Airbus has been flown unstable (unaugmented) for five minutes through the pitch trim system, with a time delay of over a second--but without attempting approach or landing. Considering higher-gain tasks and a possibly more severe environment, we cannot recommend such large relaxations. Again quoting van Gool and Mooij,

Our experience with time delays lead us to believe that for closed-loop control of transport aircraft in approach and landing the Level 1 boundary on equivalent time delay (determined with the equivalent system technique) is higher than the Mil Spec value of 0.1 s, but it will certainly not be as high as 0.4 s (in NLR experiments we obtained satisfactory pilot ratings with 0.25 s equivalent delay in pitch and roll control).

MIL-STD-1797A
APPENDIX A

MIL-STD-1797A
APPENDIX A

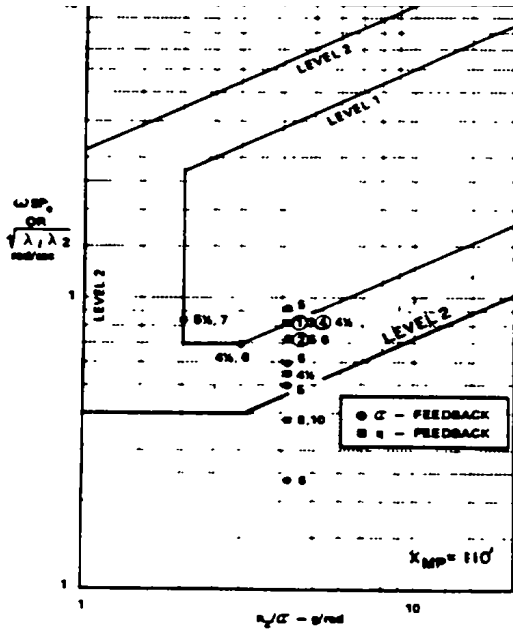

a) Long aft tail, $x_{mp} = 110$ ft

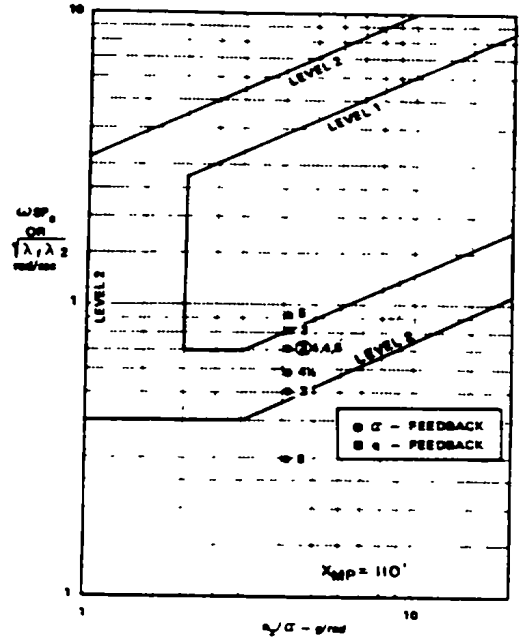

b) Canard, $x_{mp} = 110$ ft

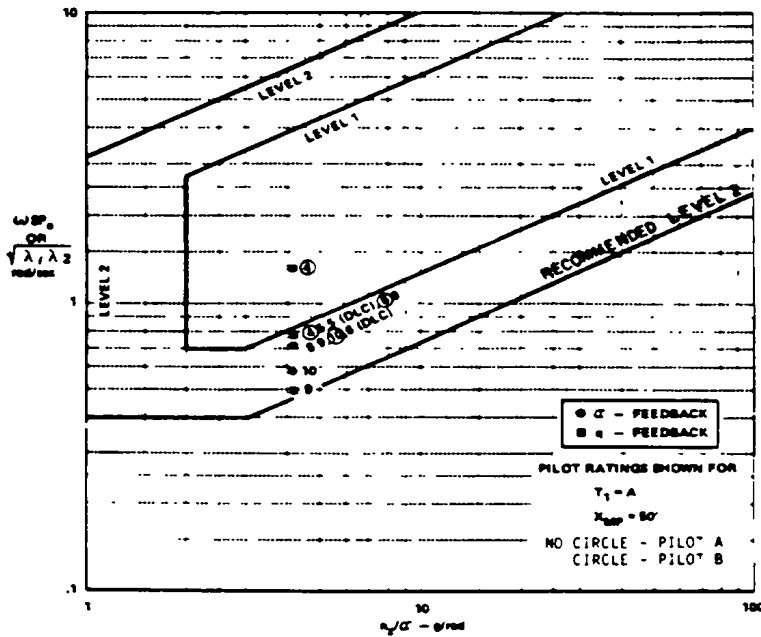

c) Short aft tail, $x_{mp} = 50$ ft

(x_{mp} is the distance of the pilot forward of the center of gravity)

FIGURE 39. Pilot ratings for large airplanes (nominal equivalent short-period parameters) from AFWAL-TR-81-3118.

MIL-STD-1797A
APPENDIX A

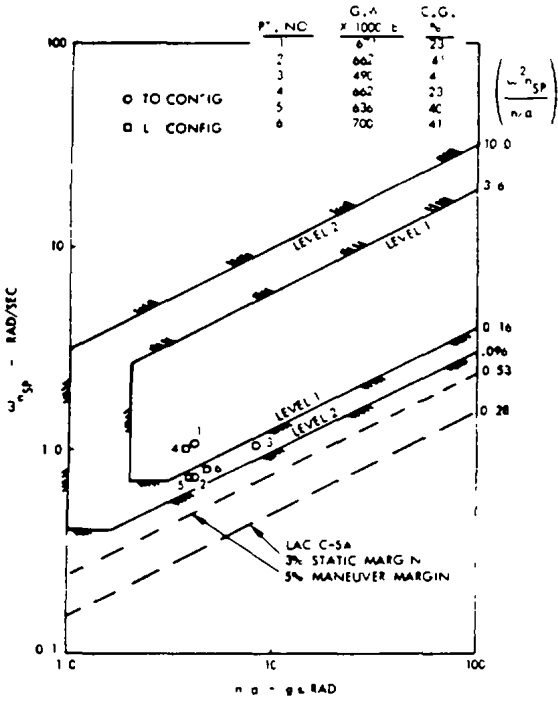

a) C-5A Category C flight data.

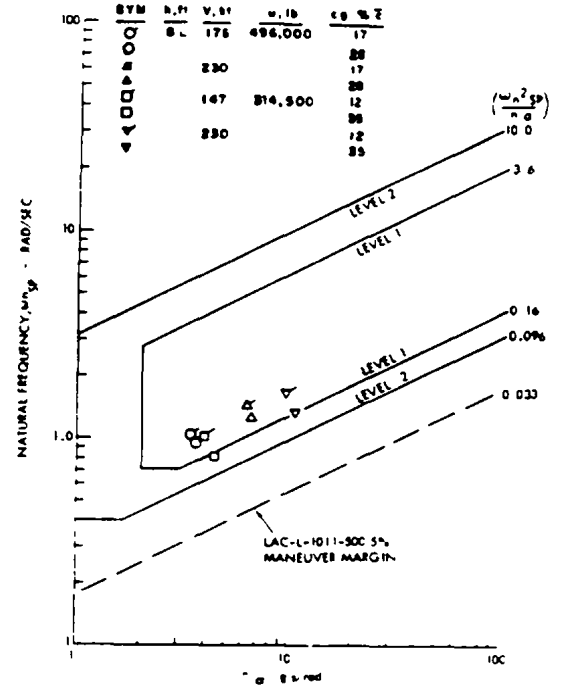

b) L-1011 takeoff configuration.

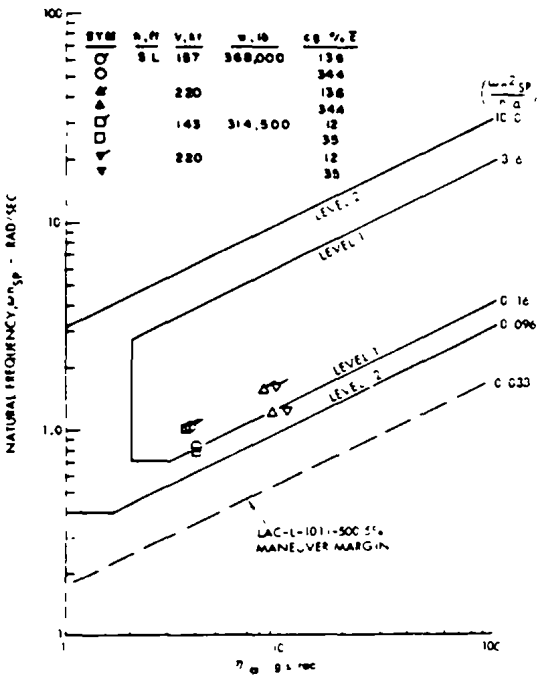

c) L-1011 power approach configuration.

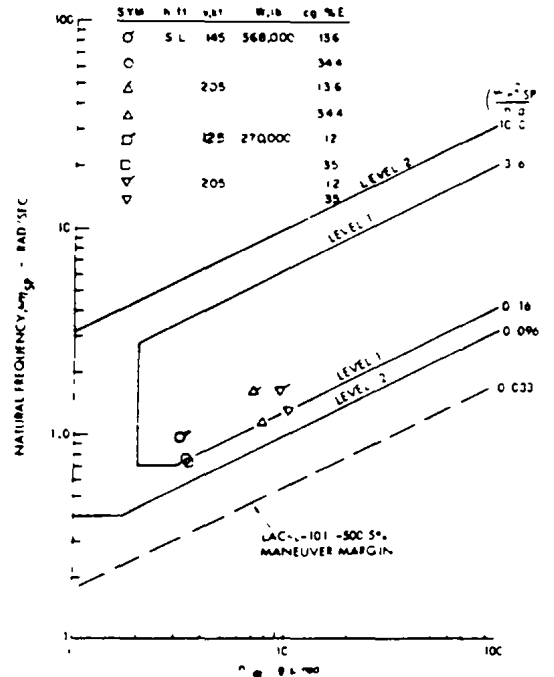

d) L-1011 landing configuration.

FIGURE 40. Category C flight data for the Lockheed C-5A and L-1011, AFWAL-TR-83-3015.

MIL-STD-1797A
APPENDIX A

MIL-STD-1797A
APPENDIX A

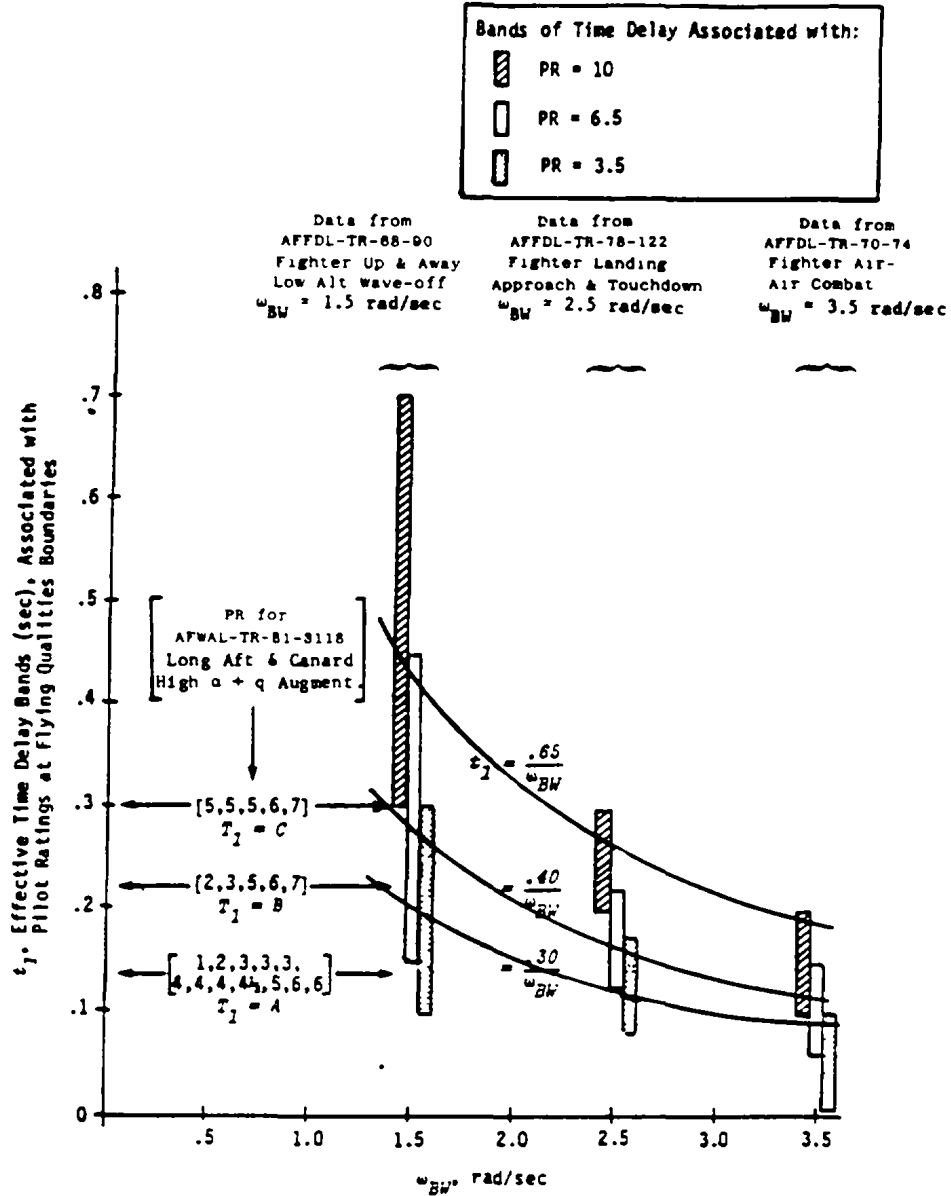

FIGURE 41. Time delay bands associated with flying qualities boundaries vs bandwidth, AFWAL-TR-81-3118.

2. $\omega_{sp}T_{\theta_2}$, ζ_{sp} criterion

Preliminary, straight-line boundaries of $\omega_{sp}T_{\theta_2}$ and ζ_{sp} are shown on figure 42 (solid lines). The data fit these limits with a confidence level of about 82 percent, so the boundaries seem to work well. An even better fit is given by the dashed lines on figure 42, which correlate with more than 90 percent of the ratings. Note that these latter boundaries tend to eliminate combinations of low damping and low frequency. We have therefore elected to set the criterion boundaries based on the dashed lines on figure 42. The minimum levels of ω_{sp} (independent of $\omega_{sp}T_{\theta_2}$, taken directly from the ω_{sp} , n/α criterion, are presented in a table on figure 25c. The minimum levels of $1/T_{\theta_2}$ are based on the n/α of limits in figure 13c by assuming an approach speed of 135 kt and noting that $1/T_{\theta_2} = (g/V)(n/\alpha)$.

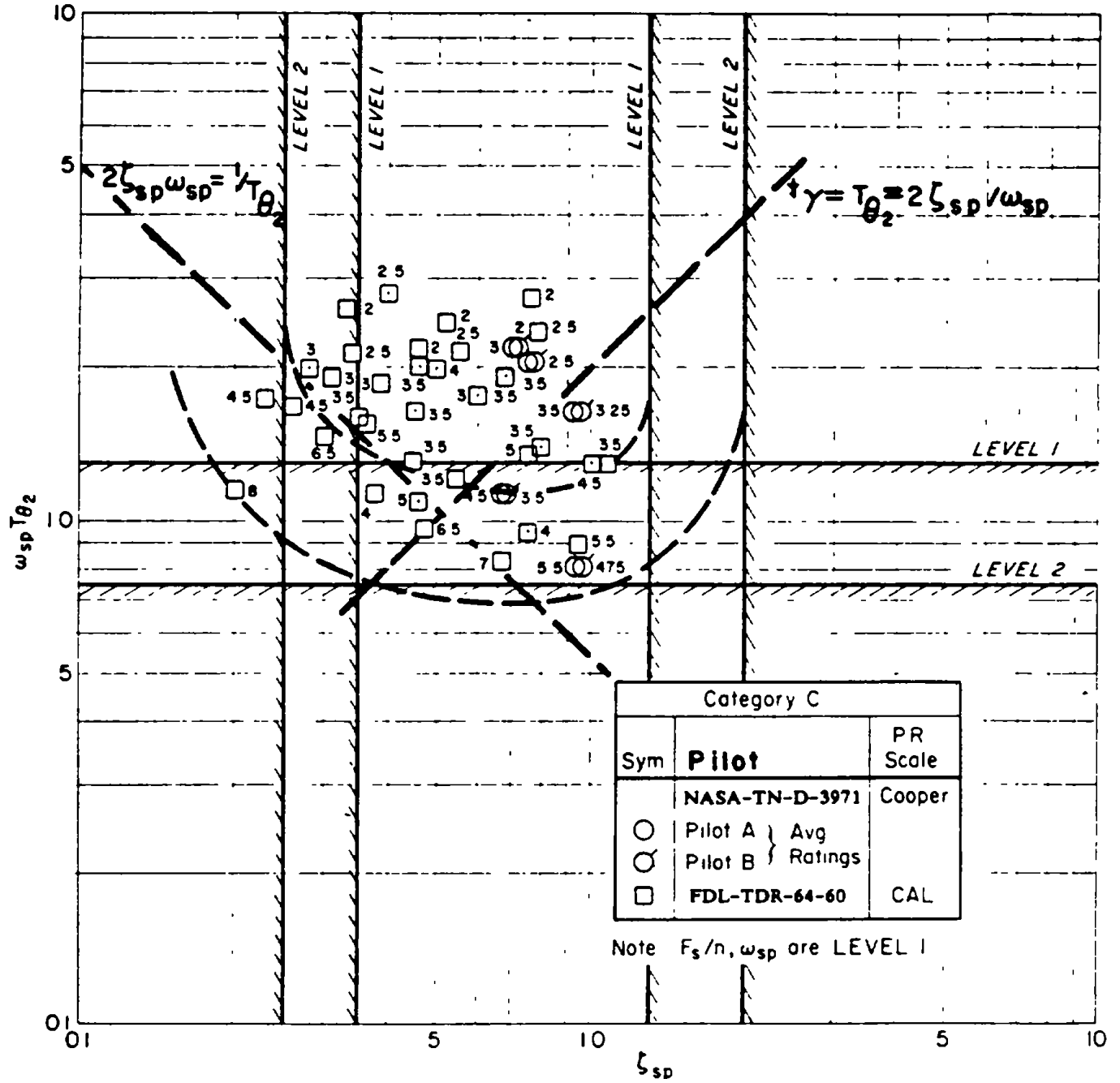

FIGURE 42. Alternate Category C short-period flying qualities requirements.

MIL-STD-1797A
APPENDIX A

Gibson's (AGARD-CP-333) time-response criteria are seen to correlate well. The more complete criteria in ICAS-86-5.3.4 indicate that the agreement is associated with flight path delay of 2 seconds for the large B-367-80 (NASA-TN-D-3971) and with sluggish attitude response for the small T-33 (FDL-TDR-64-60) even though the path delay is only 1 second. For the examples given, a minimum Level 1 $\omega_{sp}T_{\theta_2}$ value of 1.8 is suggested, limiting the time to peak pitch rate to 2 seconds (large aircraft NASA-TN-D-3971) and to 1.1 seconds (Class 4 aircraft, FDL-TDR-64-60). This minimum would increase to 2.8 for many Class 4 aircraft with T_{θ_2} of nearly 2.0. The limited Navion data, not shown, do not correlate as well.

Supporting data--augmented aircraft

In this section, HOS and LOES will be examined and compared with the specification boundaries of figure 13. The sources of the HOS data are two Calspan research efforts, by Neal and Smith (AFFDL-TR-70-74) for Category A Flight Phases and by Smith (AFFDL-TR-78-122) for Category C. The matching was generally done only on the pitch response, with $1/T_{\theta_2}$ fixed.

Neal-Smith data (AFFDL-TR-70-74)

The in-flight NT-33 experiments conducted by Neal and Smith represent a first look at generic variations typical of highly augmented aircraft. For evaluation of HOS characteristics and criteria, 51 separate FCS/short-period configurations were flown on the USAF/Calspan NT-33. Of these, some require qualifications: tests conducted at 250 kt ($n/\alpha = 18.5$) were limited to a load factor of 2.5 g, due to buffet onset; Neal and Smith reported that the pilots did not fly these tests as aggressively as they did the high-speed (350 kt) tests.

Figure 43 shows the equivalent dynamics of the 51 Neal-Smith configurations (from MDC Rpt A6792) and corresponding Cooper-Harper ratings. The frequency and damping ratio limits have been cross-plotted to facilitate presentation of the data. Figure 43a includes actual pilot ratings for each pilot; for those cases which have $\tau_e < 0.1$ (Level 1), correlation is quite good. There is clearly a relationship between τ_e and PR (figure 43b), though the τ_e limits appear to be too lenient since many of the configurations which are predicted to have Level 1 ζ_{sp} and ω_{sp} have higher (poorer) ratings than predicted by τ_e alone. In figure 43b only the mean pilot rating and standard deviation have been plotted, to reduce the number of data points.

A point-by-point comparison of the LOES data on figure 43 shows that the flying qualities Levels are accurately predicted for about two-thirds of the configurations. (This requires some liberal interpretation, e.g., if a PR change of one-half rating would improve correlation, the configuration is assumed to fit the criterion. Such a PR variation is well within the range of normal ratings variations.) This correlation rate is not outstanding, but is close to that found for flying qualities data in general (for example, the data used in AFFDL-TR-69-72 to define the ζ_{sp} and ω_{sp} boundaries of MIL-F-8785B). Several Level 2 rated configurations lie well within the Level 1 boundaries. However, the four configurations with $\zeta_e \doteq 0.4$ indicate that if the damping ratio lower limits were increased correlation would improve. This is in contradiction with the results of the previous section, where a decreased ζ_{sp} limit would improve correlation for classical aircraft.

Not surprisingly, the $\omega_{sp}T_{\theta_2}$ criterion does not correlate the AFFDL-TR-70-74 data any better (figure 44). Correlation would be improved if the minimum damping for Level 1 were increased to 0.5 and if $\omega_{sp}T_{\theta_2}$ were increased to a value around 1.85. Both changes would be incompatible with the data base for classical unaugmented aircraft.

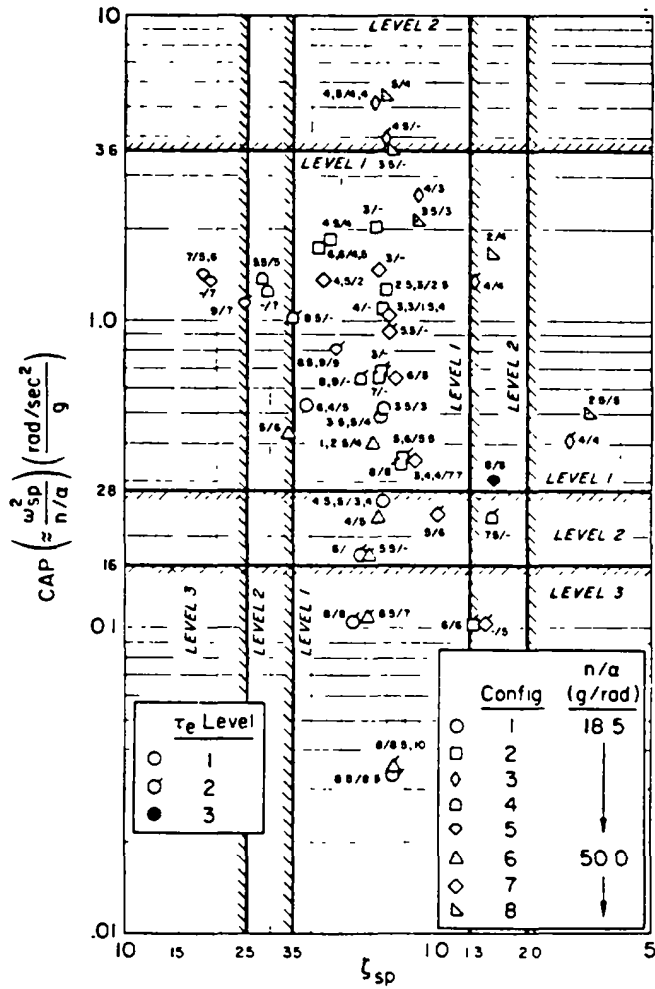

a) ζ_{sp} and ω_{sp} Requirements

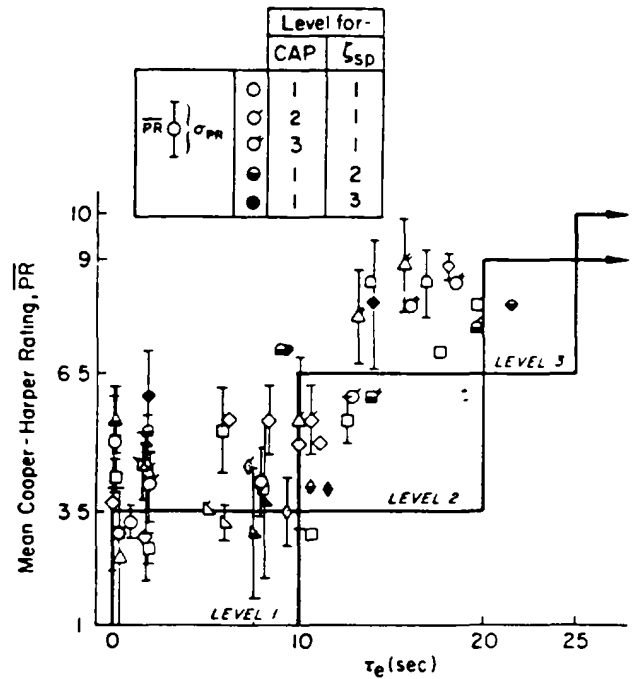

b) τ_e Requirements

FIGURE 43. Comparison of LOES dynamics with short-period requirements; Category A, Neal-Smith (AFFDL-TR-70-74) configurations, MCAIR (MDC Rpt A6792) matches.

MIL-STD-1797A
APPENDIX A

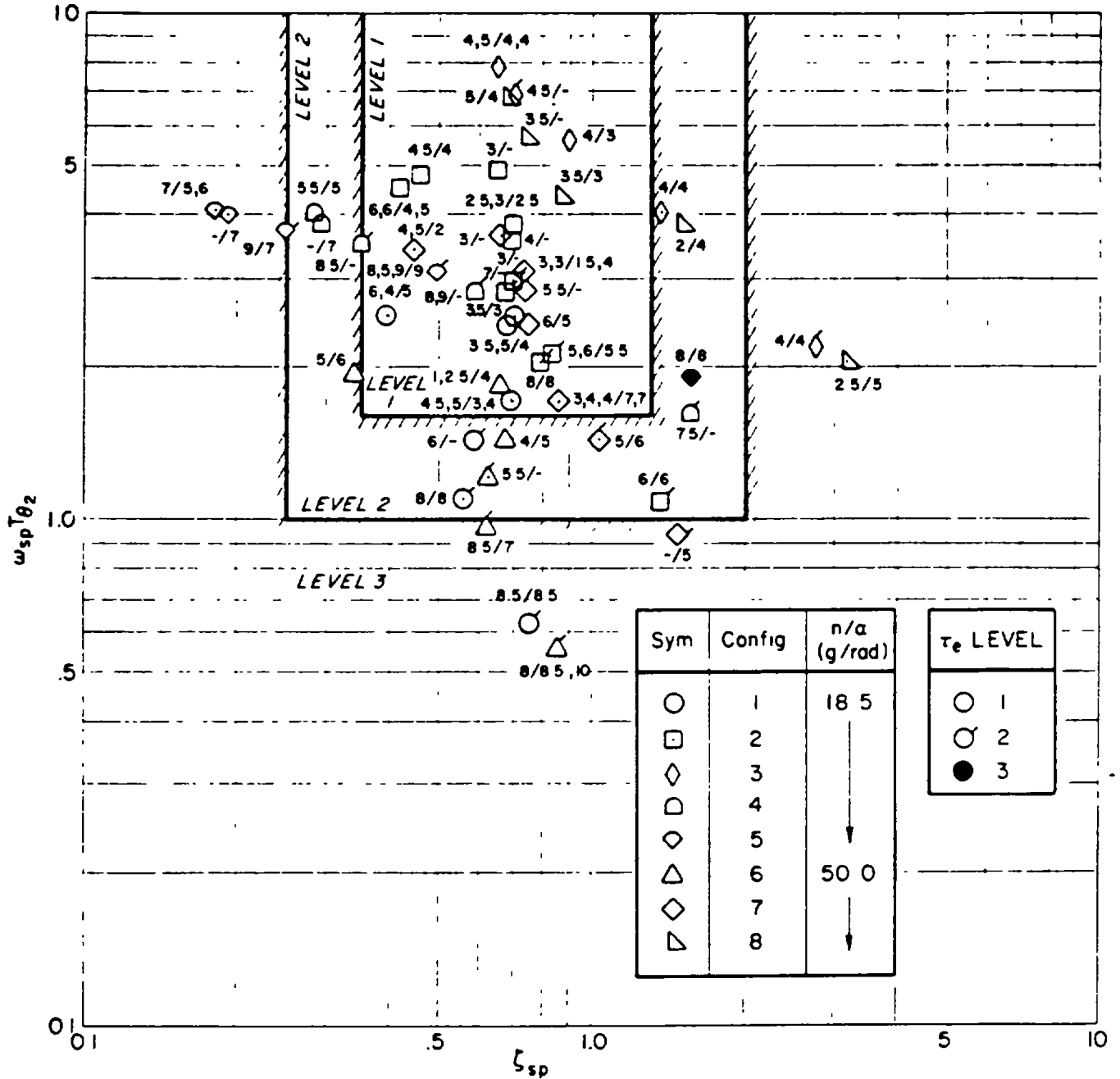

FIGURE 44. Comparison of Neal-Smith LOES characteristics with $\omega_{sp} T_{\theta_2}$ vs ζ_{sp}

The inconsistency between the unaugmented and augmented airplane data bases needs further study. Until such analyses can be conducted, we have elected to utilize the MIL-F-8785C boundaries, which are based on classical airplane data. However, for the purposes of guidance, according to the data the equivalent frequency and damping for Level 1 augmented aircraft should meet the following criteria for Category A Flight Phases:

$$\omega_{sp} T_{\theta_2} \geq 1.85 \text{ or } 3.6 \geq \omega_{sp}^2 / (n/\alpha) \geq 0.37, \zeta_{sp} \geq 0.50$$

MIL-STD-1797A
APPENDIX A

LAHOS data (AFFDL-TR-78-122)

A systematic evaluation comparable to the Neal-Smith study was conducted for HOS effects in landing approach (Category C). The Landing Approach Higher Order System (LAHOS) study (AFFDL-TR-78-122) provides a good set of data for comparing LOES with Category C requirements.

Figure 45a compares LOES matches with $\omega_{sp}^2/(n/\alpha)$ vs ζ_{sp} , with τ_e indicated; and the data are plotted against the allowable time delay (τ_e) requirements on figure 45b, with CAP and ζ_{sp} noted. The LAHOS data correlate well with the boundaries. In fact, the flying qualities of about 85 percent of the LAHOS configurations are accurately predicted. The only area of poor correlation on figure 45 involves those configurations which should have Level 1 flying qualities, but are rated by the pilots as Level 2. This may be in part a function of the fidelity of the tests and the realism of the tasks: a combination of instrument and visual approaches through touchdown and landing, or with intentional go-around maneuvers. Most of the classical data upon which the short-period requirements are based (see AFFDL-TR-69-72) were generated for approach and go-around tasks only, seldom including actual landing, which is normally the most critical area. The LAHOS data may therefore be more representative of flying qualities in the terminal phases, of flight. AFFDL-TR-78-122 discusses this at some length.

One shortcoming of LAHOS is that the equivalent systems do not cover a wide range of ζ_{sp} and ω_{sp} (figure 45a); these are Level 2 or worse for only nine of the 46 configurations. LAHOS is primarily an exercise of the τ_e limits (figure 45b). (This is not a shortcoming of the LOES approach, but an artifact of the range of HOS evaluated in the LAHOS program).

Not surprisingly, $\omega_{sp} T_{\theta_2}$ vs. ζ_{sp} is very similar (figure 46). Some improvement in the correlations would be possible by increasing the $\omega_{sp} T_{\theta_2}$ limit to 1.85. There is one data point to suggest a possible increase in $\omega_{sp} T_{\theta_2}$ to 2.2.

Gibson (AGARD-CP-333) recommends cutting off the lower right-hand corner of figure 36's Level 1 bound ($\omega > 2\zeta$ for his $t_\gamma < T_{\theta_2}$) to eliminate negative dropback.

Level 3

Substantiation for allowing an aperiodic divergence with a time to double amplitude of 6 sec for Level 3 flying qualities was given in AFWAL-TR-81-3109. The essence of that discussion is repeated below.

In response to a pulse control input, stable aircraft reach steady values of α , h and V ; unstable aircraft have the same initial response, then diverge, as illustrated by figure 47 (from NASA-TM-X-62). For a supersonic transport design, impulse responses are shown for various degrees of static instability as C_{m_α} is varied. Also shown is the response of a configuration having much more static instability, with time to double amplitude reduced by a pitch damper. Evaluation pilots rated both of these configurations unacceptable, but termed the latter's characteristics insidious. On the other hand, Schuler's (AFWAL-TR-82-3014) ground-based simulation showed additional total damping to be helpful. From NASA-TN-D-173, commenting on an F9F-2 airplane with static instability ameliorated by a damper to give about 6 seconds to double amplitude:

The rate of divergence of the airspeed was scarcely noticeable to the pilots in normal flying. However, this degree of instability might be objectionable for flight operations where accurate control of airspeed is required.

MIL-STD-1797A
APPENDIX A

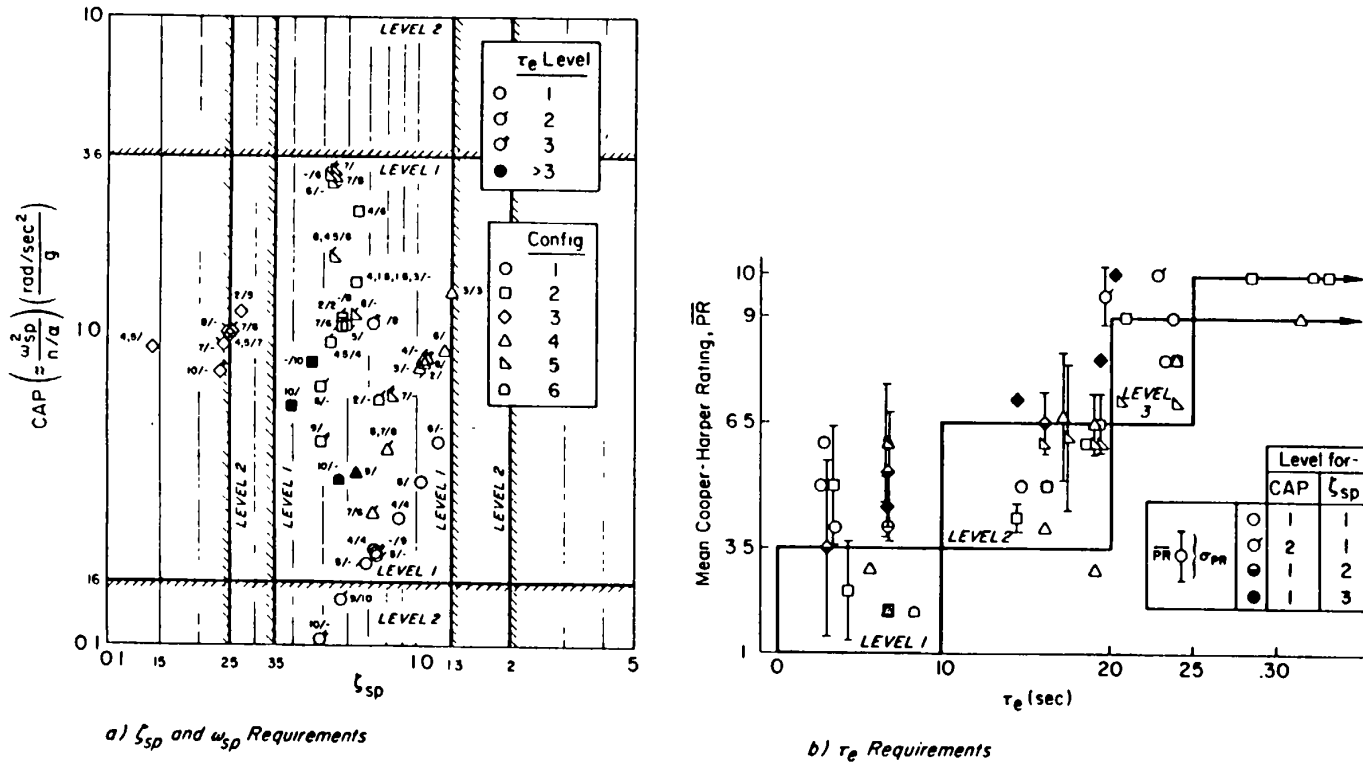

FIGURE 45. Comparison of LOES dynamics with short-period requirements; Category C, LAHOS (AFFDL-TR-78-122) configurations, MCAIR ("Equivalent Systems Approach for Flying Qualities Specification").

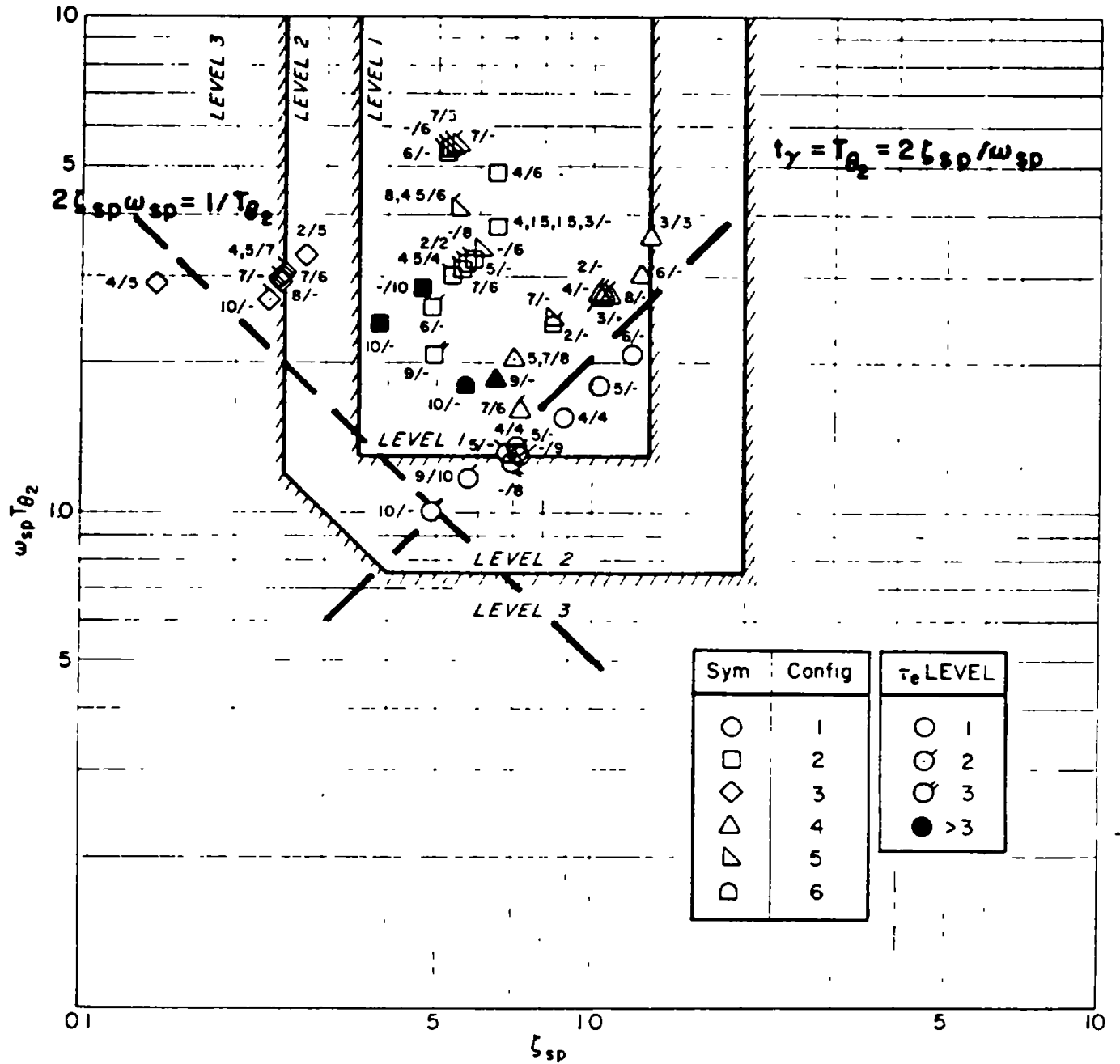
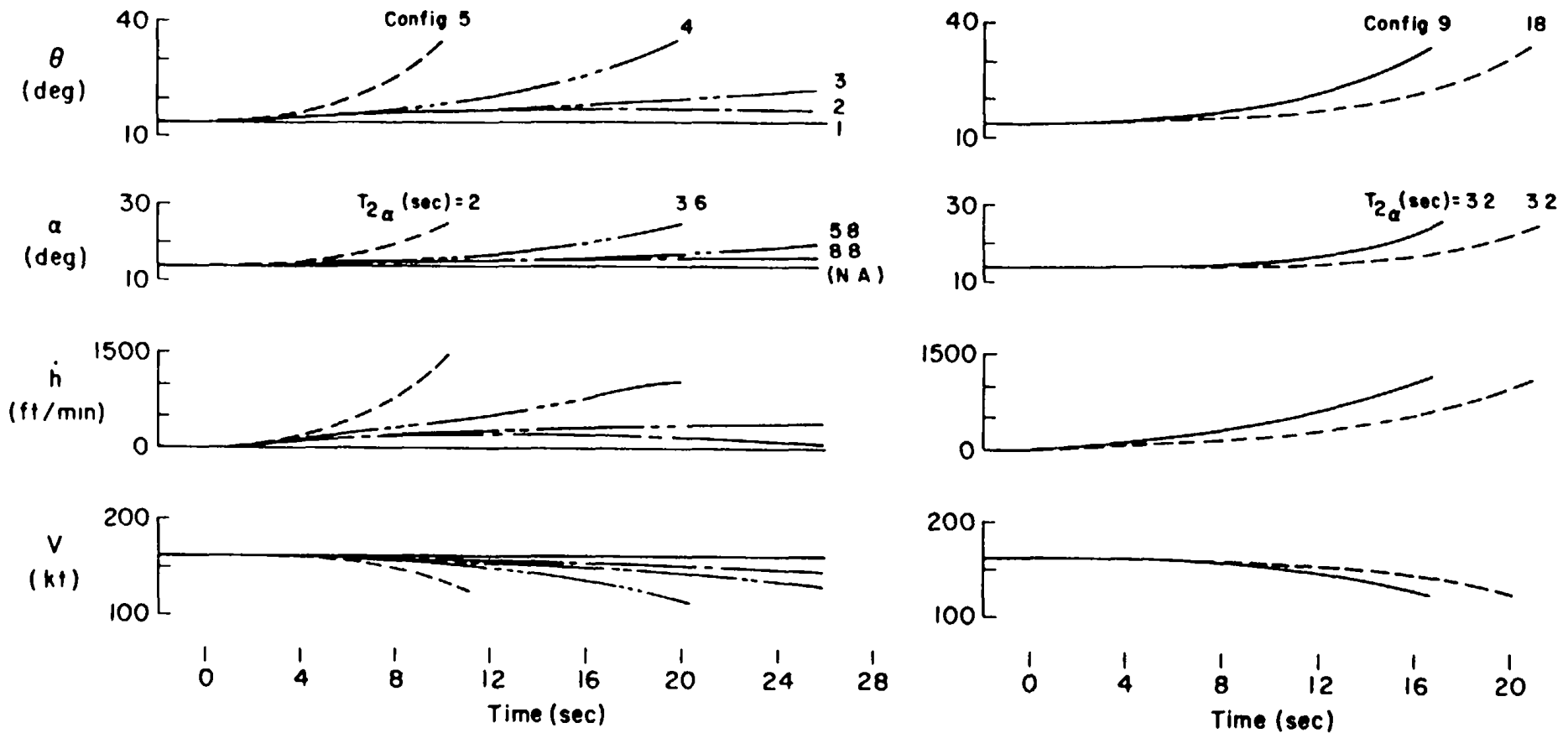

FIGURE 46. Comparison of LAHOS LOES characteristics with $\omega_{sp} T_{\theta_2}$ vs. ζ_{sp} .

From NASA-TN-D-779, pilot tolerance of aperiodic instability is much greater than of oscillatory instability (figure 48). In that variable-stability YF-86D evaluation, an aperiodic divergence was not considered safe with less than 1 sec to double amplitude: "there was a dangerous situation in that a short distraction of the pilot's attention could allow the unstable vehicle to diverge to the point that it was difficult to recover." For statically stable configurations "the unacceptable boundary is close to the zero damping boundary over most of the frequency range...in the very low-frequency and very high-frequency ranges a small amount of positive damping is required to remain within the acceptable region." Commenting on this different tolerance, Taylor and Day (NASA-TN-D-746) state:

MIL-STD-1797A
APPENDIX A



a) Comparison of Linear $C_m(\alpha)$ Configurations 1-5

b) Effect of Increased Pitch Damping with Same T_2 . ($C_{m\dot{\alpha}} + C_{m\ddot{\alpha}}$) for Config 18 was 5 Times That of Config. 9

FIGURE 47. Comparison of effects of various stability characteristics on airplane response to elevator pulse (-5 deg for 0.2 sec at $t = 0$) (NASA-TM-X-62).

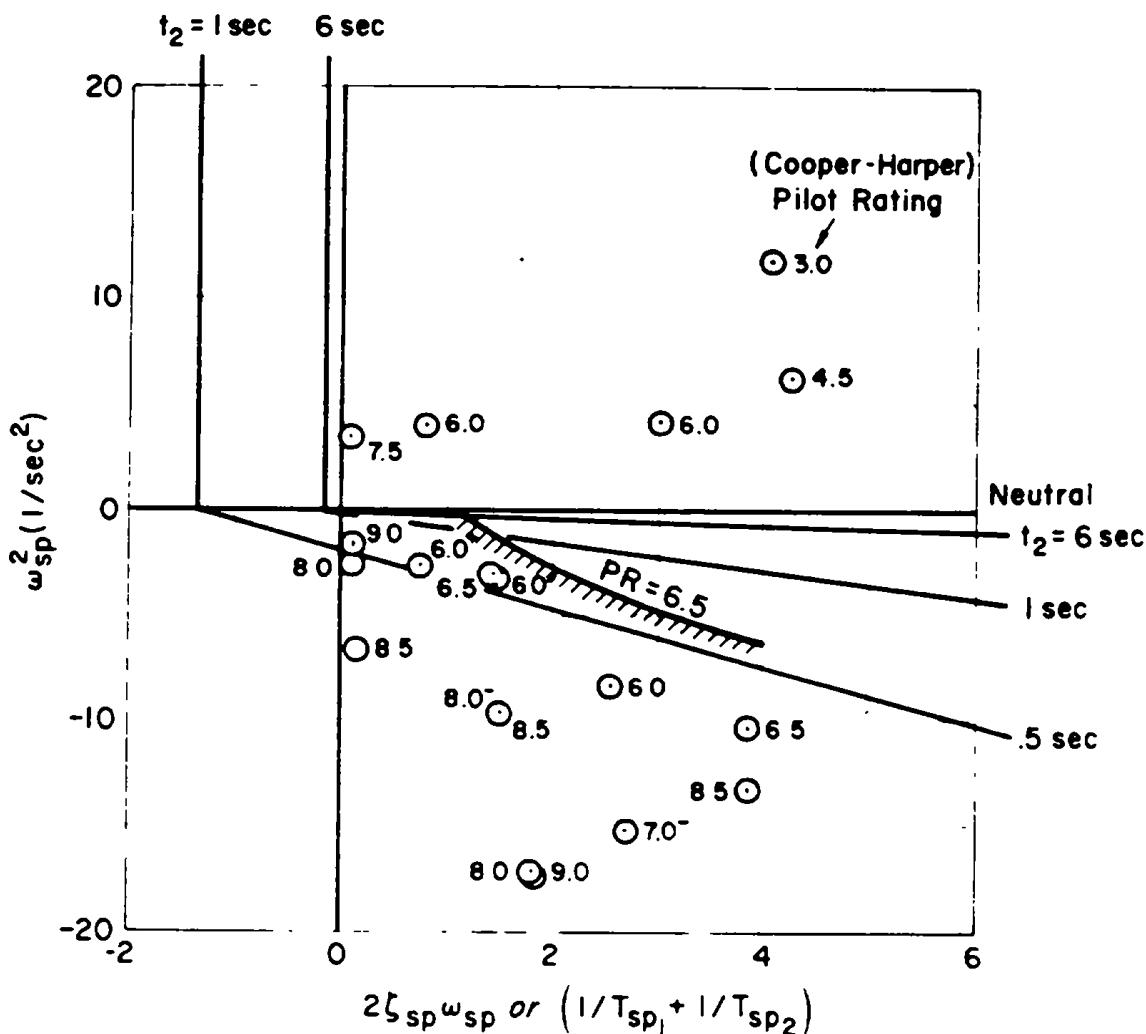

FIGURE 48. Contours of constant pilot opinion in statically unstable region; constant stick-to-stabilizer gearing (NASA-TN-D-779).

At the higher frequencies, the technique for controlling the motion was not learned as quickly...Controlling the pure divergence in the region of a static instability was more natural and less tiring than controlling the oscillatory airplane motions, inasmuch as the pilot need only counteract the angle-of-attack divergence without leading the motion to stabilize the aircraft.

The unchanged phugoid requirement, $T_2 \geq 55$ seconds for Level 3, still limits the low-frequency tolerable oscillatory instability (the α , q , and n_z feedbacks used in these variable-stability airplanes would not suppress the phugoid mode in the region of low short-period frequency and damping). Higher-frequency oscillatory instabilities are unlikely (except possibly through control-system failures), requiring considerable negative aerodynamic damping; the limit of 6 seconds to double amplitude would fit the Level 3 boundary of NASA-TN-D-779 for $0 < \omega < 6$ rad/sec.

For aperiodic instability, NASA-TN-D-211 shows that the boundary of acceptability for emergency condition (Cooper 6.5) was insensitive to the value of lift-curve slope, or $1/T_{\theta_2}$, or n/α , for positive lift-curve slopes. This boundary value was 2 seconds to double amplitude.

MIL-STD-1797A
APPENDIX A

AFFDL-TR-72-143 demonstrates that at least at low speeds, the short-period approximation can give a grossly incorrect value of T_2 . The T_2 obtained from the angle-of-attack trace matched the three-degree-of-freedom theoretical value fairly well when $C_m(\alpha)$ was actually linear and T_2 was not too large. NASA-TM-X-62 and AFFDL-TR-72-143 both elaborate on the range of values for time to double amplitude obtained by different means: calculation from three-degree-of-freedom equations and various simplifications, measurement from α , θ or V responses. $M(\alpha)$ nonlinearities gave different results for nose-up and nose-down perturbations; of course the worst direction would govern, for all reasonable magnitudes. Most of the evaluations gave some consideration to turbulence. The AFFDL-TR-72-143 baseline configuration had a Level 2 value of $d\gamma/dV$, but zero values were included in the evaluation--with a little improvement in rating, but less noticeable in turbulence. The evaluations considered both visual and instrument flight.

On the basis of all these considerations, 6 seconds to double amplitude seems a reasonable, safe limit. However, Schuler's fixed-base simulation (AFWAL-TR-82-3014) shows that the tolerable value of the unstable root, λ_1 , is affected by the value of the other, stable root, λ_2 . The latter root must be at least a certain minimum, but λ_2 larger than that permits some increase in the instability of λ_1 . Operators may be well advised to give pilots of potentially unstable aircraft some flight simulator experience with such instability. It should be noted that pitch attitude and airspeed excursions will double in amplitude at approximately the same rate, since (without autothrottle) $\dot{u} \doteq g\theta$. Hence the allowable divergence in attitude is the same as airspeed response to attitude (see 4.4.1).

It is desirable, though impractical at this time, to make the allowable instability a function of time. Clearly an instability in cruise, where it might be hours before a runway is available, could be very tiring to the pilot.

MIL-STD-1797A
APPENDIX A

C. Transient peak ratio, rise time, effective delay

The pitch rate response to a step input of pitch controller force, and also to a step controller deflection, calculated from two-degree-of-freedom equations of motion (i.e., with speed constrained) shall exhibit the characteristics defined in the following manner.

Two straight lines are drawn on the pitch rate time history (see figure 49) and the following measurements are defined:

- a. A horizontal line defining the steady-state pitch rate.
- b. A sloping straight line tangent to the pitch rate time history at the point of maximum slope. This line is extended to intersect the steady-state line and the time axis.
- c. Time t_1 measured from the instant of the step controller input to the time at the intersection of the maximum-slope line with the time axis.
- d. Time t_2 measured from the instant of the step input to the time corresponding to the intersection of the maximum slope line with the steady-state line.
- e. The amplitude quantities Δq_1 and Δq_2 measured as follows: $\Delta q_1 \triangleq$ maximum pitch rate minus the steady state; $\Delta q_2 \triangleq$ the steady state minus the first minimum.

The above-defined measurements shall meet the following design criteria, for step inputs of cockpit-controller force and also for step inputs of cockpit-controller deflection, of magnitudes to produce both small changes typical of fine tracking and large maneuvers up to limit load factor.

The equivalent time delay t_1 shall be within the limits

Level	Equivalent time delay
1	$t_1 \leq .12 \text{ sec}$
2	$t_1 \leq .17 \text{ sec}$
3	$t_1 \leq .21 \text{ sec}$

For t_1 , use the step controller deflection for a deflection control system (pilot controller deflection commands the control effectors) and the step controller force for a force control system (pilot controller force commands the control effectors).

The transient peak ratio $\Delta q_2 / \Delta q_1$ shall be equal to or less than the following:

Level	Max $\Delta q_2 / \Delta q_1$
1	$\leq .30$
2	$\leq .60$
3	$\leq .85$

MIL-STD-1797A
APPENDIX A

The rise time parameter $\Delta t = t_2 - t_1$ shall have a value between the following limits:

Level	Nonterminal Flight Phases		Terminal Flight Phases	
	Min Δt	Max Δt	Min Δt	Max Δt
1	$9/V_T$	$500/V_T$	$9/V_T$	$200/V_T$
2	$3.2/V_T$	$1600/V_T$	$3.2/V_T$	$645/V_T$

where V_T is true airspeed, ft/sec.

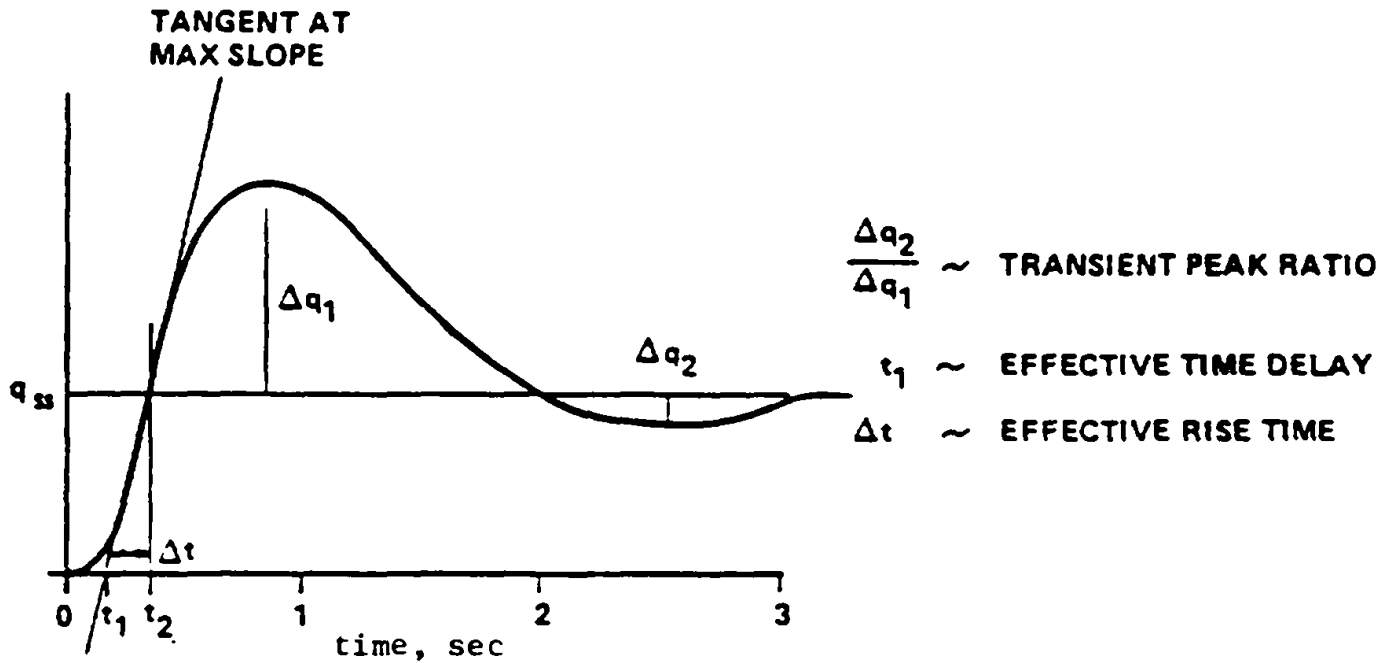

FIGURE 49. Pitch rate response to step input of pitch controller force or deflection.

The product of the control-force gradient in steady maneuvering flight, F_s/n , and the maximum frequency-response amplitude ratio of pitch acceleration to pitch control force, $|\ddot{\theta}/F_s|_{\max}$, shall not exceed the following limits:

Level 1	3.6 rad/sec ² /g
Level 2 and 3	10.0 rad/sec ² /g

For Level 3, T_2 , the time to double amplitude based on the value of the unstable root, shall be no less than 6 seconds. In the presence of any other Level 3 flying qualities, ζ_{sp} shall be at least 0.05 unless flight safety is otherwise demonstrated to the satisfaction of the procuring activity. T_2 applies to the value of the unstable root: $T_2 = -(\ln 2)/\lambda$ where λ is the value of the unstable root.

BACKGROUND

The time-response design criteria limit characteristics of the pitch rate response to pilot commands. This format avoids explicit identification of dominant roots or equivalent system models by working directly with

MIL-STD-1797A
APPENDIX A

the pitch rate transient response. Nevertheless, by virtue of assuming a conventional-appearing response these criteria do rely on a form of equivalent system. The criteria are applicable to aircraft exhibiting conventional aircraft dynamic modes and to most pitch augmentation systems, but not to high-gain pitch attitude command systems. If the residue of the phugoid or other low-frequency modes prohibits defining a constant-speed, short-term, steady-state, pitch rate, it may be necessary to apply the criteria to the pitch rate transient computed from constant-speed equations of motion. This discussion is adapted from NASA-CR-159236.

The flight experiments reported in AFFDL-TR-68-90, AFFDL-TR-70-74, AFWAL-TR-81-3116, and AFFDL-TR-78-122 have established the critical, detrimental nature of transport time delay and effective time delay resulting from cascaded dynamic elements in the control system. The limits on effective time delay are based on interpretation of the data in these documents.

Many calculation procedures have been proposed (see AFFDL-TR-70-155, AFFDL-TR-68-90, and AFFDL-TR-70-74 for example). The methods developed in AFFDL-TR-68-90 require knowing the coefficients of the characteristic equation of the higher-order system; the method of AFFDL-TR-70-155 requires a multivariable search to minimize the weighted sum of squares of errors of amplitude and phase between the higher-order system and an assumed lower-order system having a time delay function e^{-as} . AFFDL-TR-70-74 reported analog matching of time-history responses using a lower-order transfer function with a time delay; the best match was subjectively judged by the operator. These various methods yield similar but different values of the effective time delay, and they are complex in mathematical concept and application.

The effective time delay used in this time-domain requirement is defined on figure 49. It can be uniquely defined (unless the response is dominated by higher-frequency modes or an aperiodic instability) and easily evaluated either graphically or analytically. Values of t_1 are generally smaller, for example, than the time delay determined by the method of AFFDL-TR-70-155. It was necessary, therefore, to evaluate t_1 for the configurations evaluated in various experiments and to correlate these values with pilot rating.

These time-domain criteria are stated in terms of the transient peak ratio $\Delta q_2 / \Delta q_1$. The intent is to ensure adequate damping of the short-period or dominant mode of the pitch response. The specified values are based on interpretation of short-period data in AFFDL-TR-72-41 and AFFDL-TR-69-72. For a classical airplane response, the transient peak ratios would correspond to the following damping ratio values:

Level 1	TPR = .30	$\zeta = .36$
Level 2	TPR = .60	$\zeta = .16$
Level 3	TPR = .85	$\zeta = .052$

The criteria also limit the effective rise time, Δt , of the pitch rate response to a step pilot command (see figure 49). The effective rise time is related to $\omega_{sp}^2 / (n/\alpha)$ by the following:

$$\frac{\omega_{sp}^2}{nd} = \frac{\ddot{\theta}_0}{n_{z_{ss}}} \cong \frac{q_{ss}/\Delta t}{q_{ss}V_T/g} - \frac{g}{V_T\Delta t}$$

Limits on $\omega_{sp}^2 / (n/\alpha)$ are defined in MIL-F-8785C as a function of Flight Phase Category. For example, the Level 1 limits for Flight Phase Category C are

$$.16 \leq \omega_{sp}^2 / (n/\alpha) \leq 3.6 \text{ rad}^3 / (\text{g} \cdot \text{sec}^2)$$

MIL-STD-1797A
APPENDIX A

These limits can be related to the effective rise time as follows by substitution:

$$.16 \leq g/(V_T \Delta t) \leq 3.6$$

By taking reciprocals, reversing inequality signs and rearranging, the following limits for Δt result, in commensurate units:

$$g/(3.6V_T) \leq \Delta t \leq g/(.16V_T)$$

This development indicates that limits on the effective rise time, Δt , expressed as constants divided by the true speed are analogous to the constant limits on $\omega_{sp}^2/(n/\alpha)$ used in MIL-F-8785C to specify short-period frequency as a function of n/α . Separate Δt limits are stated for terminal and nonterminal Flight Phases for Level 1 and Level 2. The Level 3 limit is again 6 seconds to double amplitude.

SUPPORTING DATA

NASA-CR-159236 derives the numerical values of the Δt limits for terminal Flight Phases directly from $\omega_{sp}^2/(n/\alpha)$ limits of MIL-F-8785C. The maximum Δt limits have been increased to accommodate flight test data for existing aircraft such as the Concorde, XB-70, C-5A and from research data in "Recent Flight Test Results on Minimum Longitudinal Handling Qualities for Transport Aircraft". See figures 32 through 35. The Concorde data for cruise and the C-5A data for Flight Phase Category B in figure 32, the XB-70 test data on figure 50 together with the research data on that figure were used as the basis for reducing the Level 1 and 2 minimum frequency limits for Flight Phase Category B of MIL-F-8785C. These boundaries were then translated to maximum limits for Δt . The Level 2 boundary for Flight Phase Category C was reduced on the basis of the Concorde data in figure 51 which applies to the landing case with pitch damper OFF. The C-5A Flight Phase Category C data in that figure, also for damper OFF, tend to substantiate the proposed boundaries. In AFFDL-TR-75-3, however, the authors claim the C-5A should be considered Level 1 with dampers OFF in the landing Flight Phase and, therefore, the Level 1 boundary should be lowered. This recommendation was not accepted in preparation of the design criteria because other data in AFFDL-TR-72-41 and AFFDL-TR-69-72 substantiate the higher Level 1 boundary. The experiments reported in AFWAL-TR-81-3116 and AFFDL-TR-78-122 are the primary sources of data suitable for establishing pitch limits for t_1 , the effective time delay parameter. The data in these reports is given primary emphasis for Category C Flight Phases because the evaluation task was centered on terminal Flight Phases including flare and touchdown. Data from the experiments reported in AFFDL-TR-68-90 and AFFDL-TR-70-74 will also be used for Category A; these tasks were up-and-away or did not include the critical flare and touchdown part of landing.

The correlation of pilot ratings for AFFDL-TR-78-122 is shown on figure 52, and the data from AFWAL-TR-81-3116 is shown on figure 52. In figure 52, the points at PR = 5, 6, 7, for $t_1 < 0.1$ are not considered in the data correlation because the pilot comments indicate that these configurations were downrated for other reasons. The remaining data in figure 52 and the data in figure 53 indicate a rapid degradation in pilot rating for the flare and touchdown task as t_1 becomes greater than 0.1 sec. The data from the two independent experiments are quite consistent and have been used as the basis for the pitch design criteria. Although a band of values of t_1 and PR is indicated by the data, nominal values of t_1 have been stated for the pitch design criteria.

As part of the experiment reported in AFFDL-TR-78-122, the evaluation pilots were requested to give separate ratings for the approach and for the flare and touchdown. In addition, some approaches were terminated by a waveoff and were rated for that task. It was found that the pilot ratings were significantly less critical for the approach task than for the more critical flare and touchdown. The data on figure 54 are pilot ratings for the approach segment or for the approach and waveoff. For this less critical task, considerably larger values of t_1 are tolerable.

MIL-STD-1797A
APPENDIX A

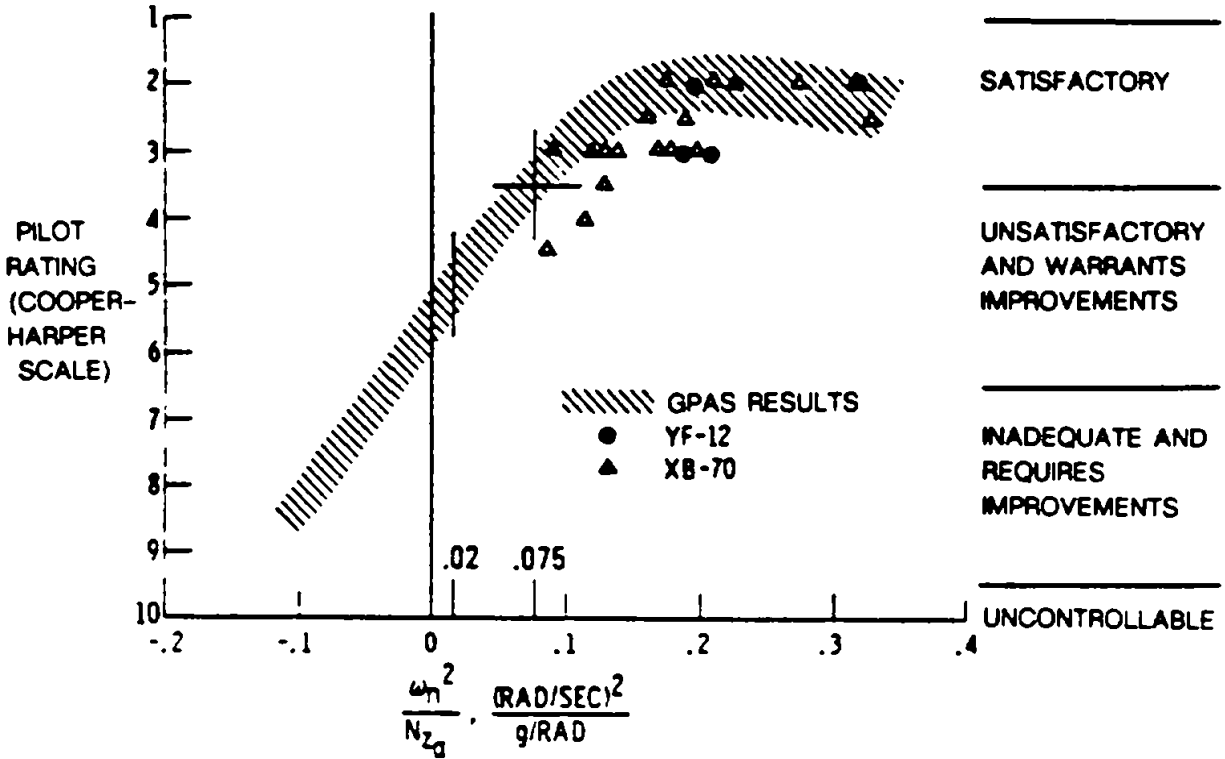
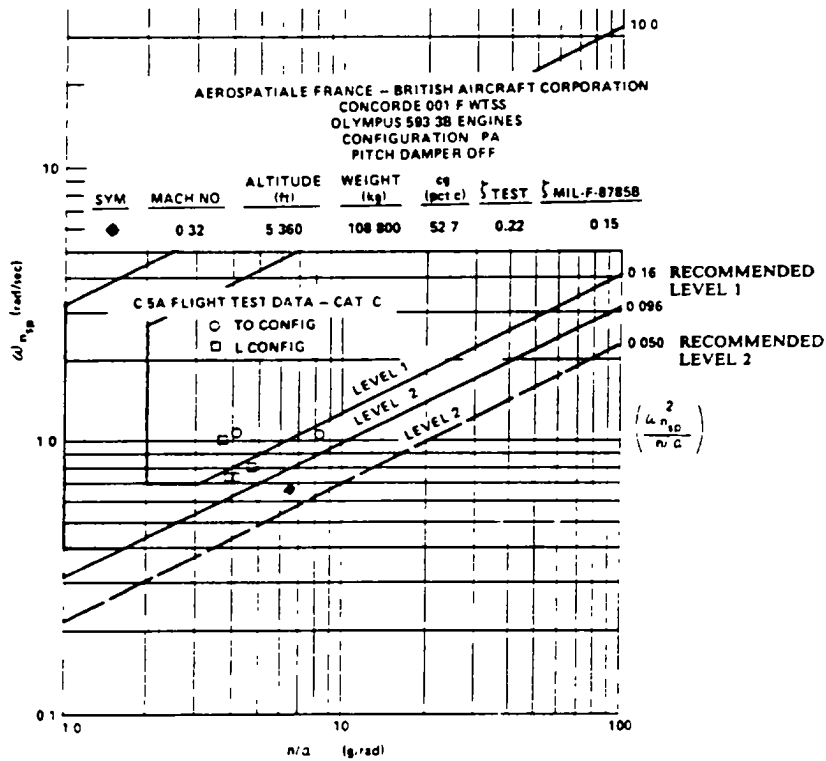

FIGURE 50. Comparison of YF-12 and XB-70 handling qualities evaluation with the GPAS results (NASA-CR-159236).



MIL-STD-1797A
APPENDIX A

FIGURE 51. Short-period frequency (NASA-CR-159236).

MIL-STD-1797A
APPENDIX A

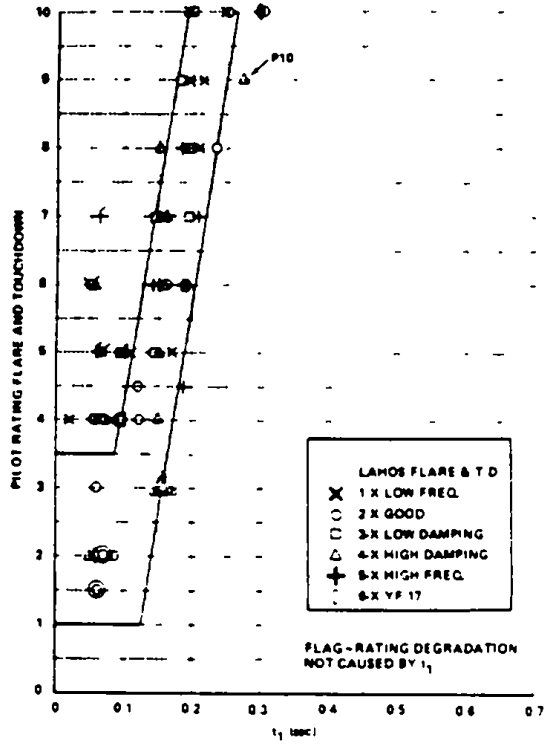

FIGURE 52. Pilot rating correlation with effective time delay (AFFDL-TR-78-122 data).

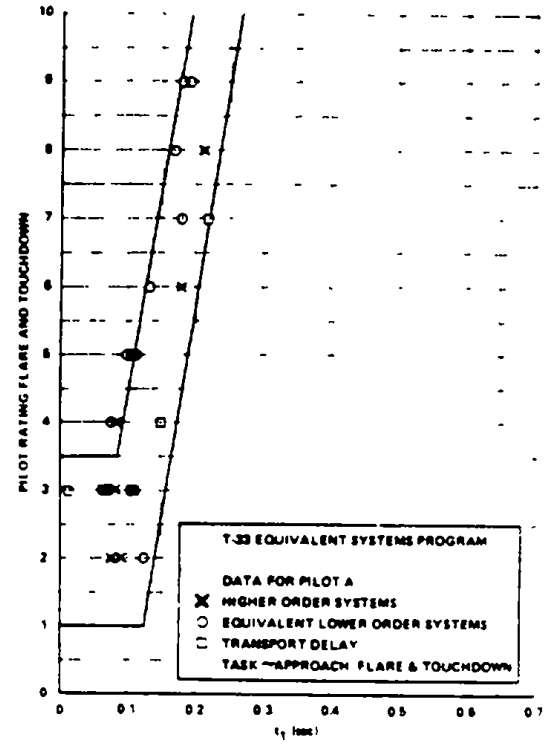

FIGURE 53. Pilot rating with effective time delay (AFWAL-TR-81-3116 data).

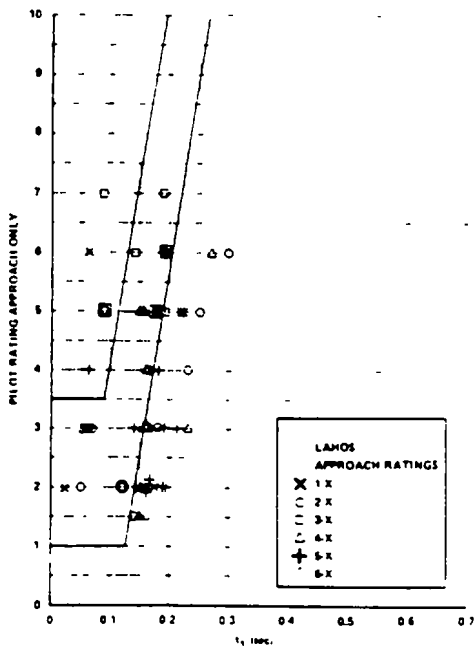

FIGURE 54. Pilot rating correlation with effective time delay (AFFDL-TR-78-122).

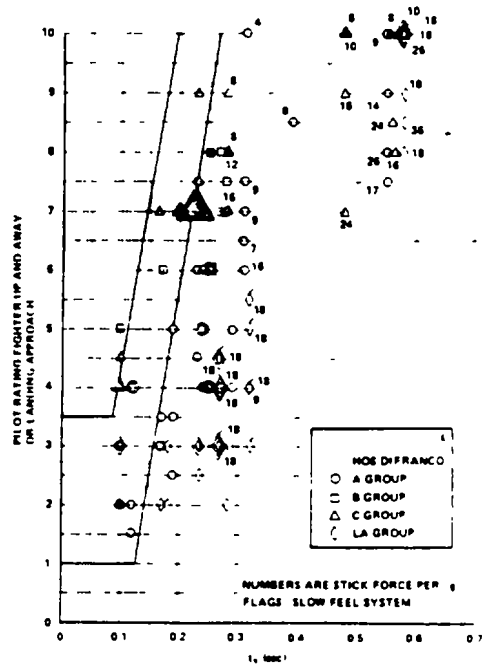

FIGURE 55. Pilot rating correlation with effective time delay (AFFDL-TR-68-90 data).

MIL-STD-1797A
APPENDIX A

The AFFDL-TR-68-90 experiment investigated the effects of higher-order control system dynamics on the flying qualities for up-and-away fighter maneuvering and for landing approach to a low-altitude waveoff. The data, plotted on figure 55, indicate that quite large values of t_1 were on occasion considered flyable. Review of the pilot comments for the cases with $t_1 > .35$ indicate that the pilots were aware of a strong pilot-induced oscillation tendency when they attempted precision closed-loop control or aggressive maneuvering. Their ratings are all unacceptable for $t_1 > .35$; the question being decided was whether or not the airplane was controllable for rather undemanding tasks, i.e., they were not attempting air-air combat maneuvering or gunnery tracking or actual landings. In addition, the cases not rated PR = 10 were generally ones for which the pilot had selected a low command gain which helped to reduce the tendency for divergent PIO. The experiment included cases with a very slow feel system. Pilots commented that they could recognize that the feel system was poor, i.e., they could individually sense both the force applied and the stick motion; they tended to be more tolerant of these cases even though large values of t_1 characterize the response to a stick force step command. The major reason that configurations with larger t_1 (beyond the lines transferred from figure 52 and 53) were rated more acceptable is thought to be that the evaluations were for a less critical task. This is certainly true for the LA Group which was evaluated for the landing approach and waveoff. It may also be true for the A, B, and C Groups even though they were supposedly evaluated for up-and-away flight in a fighter mission. Review of the pilot comments indicates the evaluation task did not emphasize aggressive maneuvering and tracking to the same extent as in AFFDL-TR-70-74.

Time history responses suitable to accurately measure t_1 were not readily available for all of the configurations evaluated in AFFDL-TR-70-74, but the data for Groups 1, 2 and 6 in that experiment are plotted on figure 56. These data indicate a lower tolerance for effective time delay than was obtained from the fighter up-and-away evaluations of AFFDL-TR-68-90. The data also indicate a reduced tolerance relative to the data from AFWAL-TR-81-3116 and AFFDL-TR-78-122 which included landing flare and touchdown. It is believed that the reduced tolerance to t_1 indicated on figure 56 is a result of the emphasis put on evaluation for air-air combat maneuvering and tracking capability in the AFFDL-TR-70-74 experiment.

Although the evaluation task has been introduced as a significant factor in the discussion of the data from various experiments, the design criteria for effective time delay in pitch have not been stated in terms of Flight Phases. The limits stated in the design criteria should be adequate to permit performance of flare and touchdown during landing, which is probably the most critical maneuver in a transport mission, and also for fighter maneuvering. To permit larger values for less critical flight phases is likely to invite too casual an attitude toward this design problem (which we have on several occasions found to be poorly appreciated by the design community) but is potentially the cause of very severe control problems such as divergent PIO near the ground.

These requirements were written for a large supersonic-cruise, transport airplane (NASA-CR-159236, which has been quoted/adapted extensively here), but the discussion relates the rise time to CAP and the transient peak ratio to the damping ratio. Thus the requirements for other classes of aircraft can also be converted from frequency to time domain. Since the presently recommended equivalent time delay limits apply across the board to all Classes, the effective time delay measured from the step response would also apply to all Classes. Note that this requirement retains the time-domain CAP [equal to $(F_S/n) M_{F_S}$] requirement as in the frequency-domain form, relating to attitude response.

Step control inputs do excite aircraft response at all frequencies. On the other hand they emphasize the high frequencies and the steady state rather than the mid-frequency range of likely crossover, which is critical for closed-loop pilot control. Such open-loop tests could not be expected to elicit all possible closed-loop control difficulties. Time-domain measures may be more directly applicable to higher-order and nonlinear responses, but step control inputs may be severely limited in size by the magnitude of some responses, be

MIL-STD-1797A
APPENDIX A

they linear or nonlinear. Of course larger impulse or doublet inputs can be used, and the time-domain requirements cast in such form.

For Level 3, see the discussion in section A and the supporting data in section B.

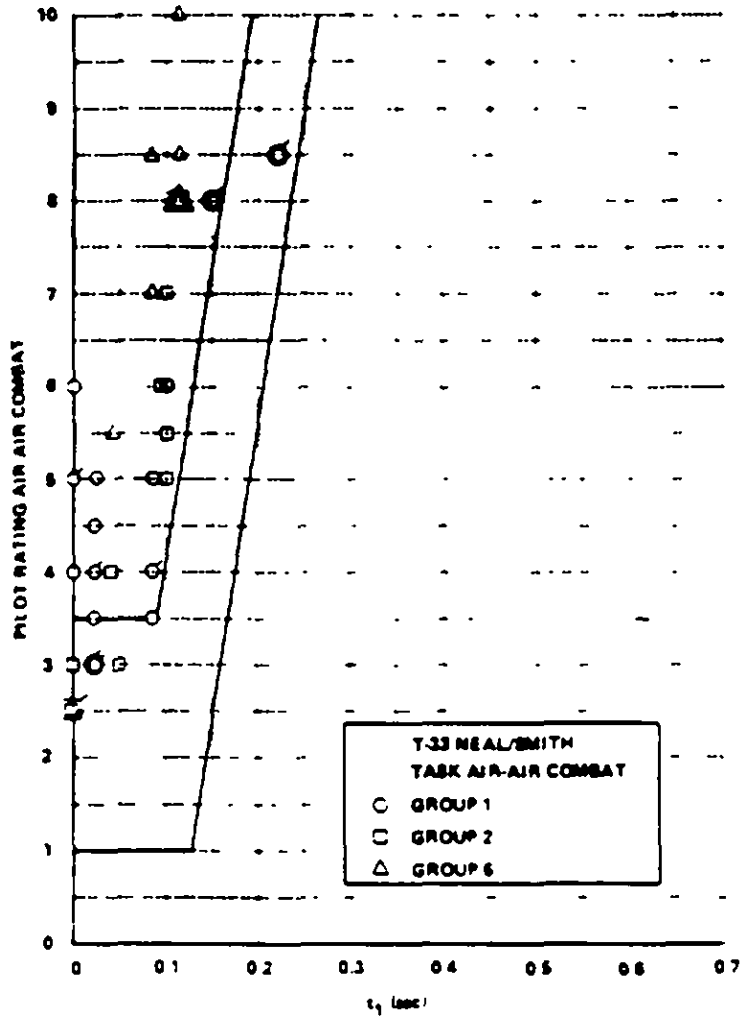

FIGURE 56. Pilot rating correlation with effective time delay (AFFDL-TR-70-74 data).

MIL-STD-1797A
APPENDIX A

D. Bandwidth, Time Delay

The bandwidth of the open-loop pitch attitude response to pilot control force for force controllers (pilot controller force commands the control effectors) and to pilot controller deflection for deflection controllers (pilot controller deflection commands the control effectors) shall be within the bounds shown on figure 57, where ω_{BW} is the highest frequency at which the responses of aircraft pitch attitude to pilot control-force and control-deflection inputs have both 45 degrees or more of phase margin and 6 dB or more of gain margin and

$$\tau_p = -(\phi_{2\omega_{180}} + 180^\circ)/(57.3 \times 2\omega_{180})$$

where ω_{180} is the frequency corresponding to -180 deg phase and $\phi_{2\omega_{180}}$ is the phase angle at twice that frequency.

For Level 3, T_2 , the time to double amplitude based on the value of the unstable root, shall be no less than 6 seconds. In the presence of one or more other Level 3 flying qualities, ζ_{sp} shall be at least 0.05 unless flight safety is otherwise demonstrated to the satisfaction of the procuring activity. T_2 applies to the value of an unstable first-order root: $T_2 = -(\ln 2)/\lambda$ where λ is the value of the unstable root.

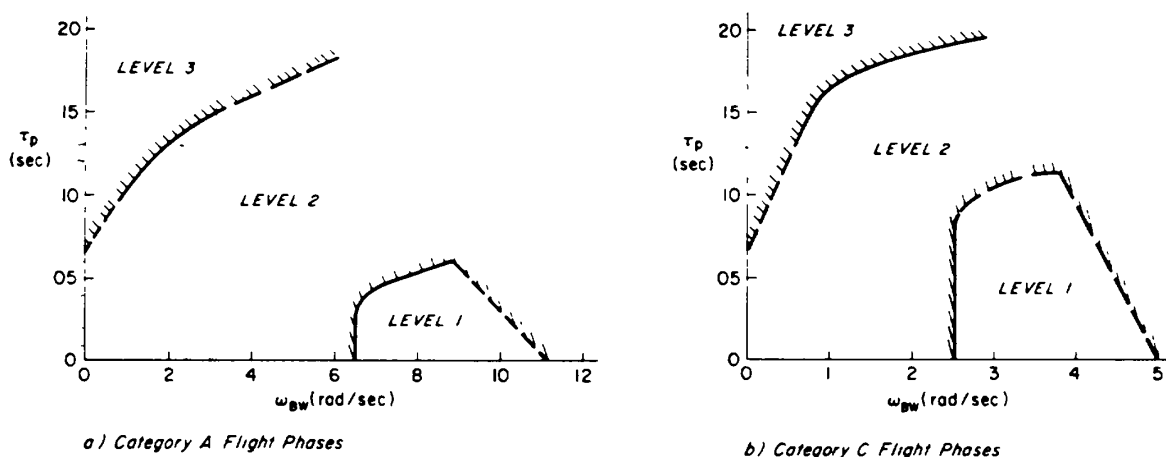

FIGURE 57. Bandwidth requirements.

BACKGROUND

A measure of the handling qualities of an aircraft is its stability margin when operated in a closed-loop compensatory tracking task. We refer to the maximum frequency at which such closed-loop tracking can take place without threatening stability as bandwidth (ω_{BW}). It follows that aircraft capable of operating at a large enough value of bandwidth will have superior performance when regulating against disturbances. A bandwidth criterion is especially useful for highly augmented aircraft in which the response characteristics are non-classical in form (i.e., have large mismatch in equivalent system fits). Although not restricted to such cases, this requirement should be utilized when the mismatch between the lower-order and higher-order systems exceed the values defined on figure 15. No assumption of pilot dynamics is necessary in applying this requirement, since any such assumption would simply shift the boundaries. Also, for Level 1 minimal pilot compensation should be necessary.

MIL-STD-1797A
APPENDIX A

The concept of using bandwidth is not new for flying qualities. A 1970 utilization of bandwidth was in the Neal-Smith criterion (see AFFDL-TR-70-74) consisting of empirical bounds on the closed-loop pitch attitude resonance $|\theta/\theta_c|_{\max}$ vs.- pilot equalization for a piloted closure designed to achieve a specified bandwidth. Experience with this criterion has shown that the results can be sensitive to the selected value of closed-loop bandwidth. The criterion developed herein bounds the value of bandwidth achievable without threatening stability, thereby removing the necessity for selecting a value for ω_{BW} a priori.

Another criterion utilizing bandwidth, suggested in AFFDL-TR-73-76, also selected a fixed value of bandwidth (1 rad/sec for power approach). It utilized the phase margin, ϕ_M , and slope of the phase curve, $d\phi/d\omega$, at the selected bandwidth frequency as correlating parameters. Again, experience has shown that the fixed value of bandwidth limits application of the criterion.

Most, if not all familiar handling quality metrics, are in fact related to bandwidth. However, these metrics are generally tailored to classical aircraft which can be characterized by lower-order systems -- for example, the q/F_S and n_z/F_S transfer functions of section A, "CAP, ...".

It is easily shown for these (and similar) transfer functions that the quality of closed-loop error regulation depends on the pilot's ability to increase the short-period root (ω_{sp}) without driving it into the right half (unstable) plane. As illustrated by the generic sketches in figure 58 for an idealized pilot supplying only gain and pure delay, aircraft with low short-period damping ratio (ζ_{sp}), frequency (ω_{sp}), or both, tend to become unstable at low values of frequency (compare figures 58a and 58b). The aircraft of figure 58 is represented as a simple short-period vehicle to simplify the example; for real highly augmented aircraft, many more roots are involved.

Consider the bandwidth frequency as occurring at some (for now) arbitrary margin below the frequency of instability (see boxes on root locus in figure 58). It can be seen from figure 58 that ω_{BW} depends uniquely on ω_{sp} , ζ_{sp} , $1/T_{\theta_2}$, and τ_e (the delay, τ_e , draws the locus to the right as gain increases). Hence these familiar flying quality metrics are, in fact, a measure of bandwidth. Again, we see that the flying qualities application of bandwidth has roots in familiar metrics.

The present impetus for using ω_{BW} as a criterion evolved from attempts to develop a flying quality specification for aircraft utilizing unconventional response modes with direct force controls (wings-level turns, pitch pointing, etc.), AFWAL-TR-91-3027. The infinite variety of responses that could occur due to coupling within and between axes made it necessary to retreat to a more fundamental metric, which turned out to be bandwidth. Strictly speaking, bandwidth in pitch involved θ/θ_c , a closed-loop describing function of pilot/vehicle response. Here, however, a pilot model is merely a unity-gain feedback and so bandwidth is specified in terms of the aircraft-alone gain and phase margins, only.

BANDWIDTH DEFINITION

The bandwidth as defined for handling quality criterion purposes is the highest frequency at which the phase margin is at least 45 deg and the gain margin is at least 6 dB; both criteria must be met (figure 59). Referring to figure 59, this describes the pilot's ability to double his gain or to add a time delay or phase lag without causing an instability ($\Phi \leq -180$ deg at the ω for 0 dB gain indicates instability). In order to apply this definition, one first determines the frequency for neutral stability, ω_{180} , from the phase portion of the Bode plot. The next step is to note the frequency at which the phase margin is 45 deg, ω_{135} . This is the bandwidth frequency as defined by phase, $\omega_{BW_{\text{phase}}}$. Finally, note the amplitude corresponding to ω_{180} and add 6 dB. Find the frequency at which this value of response magnitude occurs; call it $\omega_{BW_{\text{gain}}}$. The bandwidth, ω_{BW} , is the lesser of $\omega_{BW_{\text{phase}}}$ and $\omega_{BW_{\text{gain}}}$.

MIL-STD-1797A
APPENDIX A

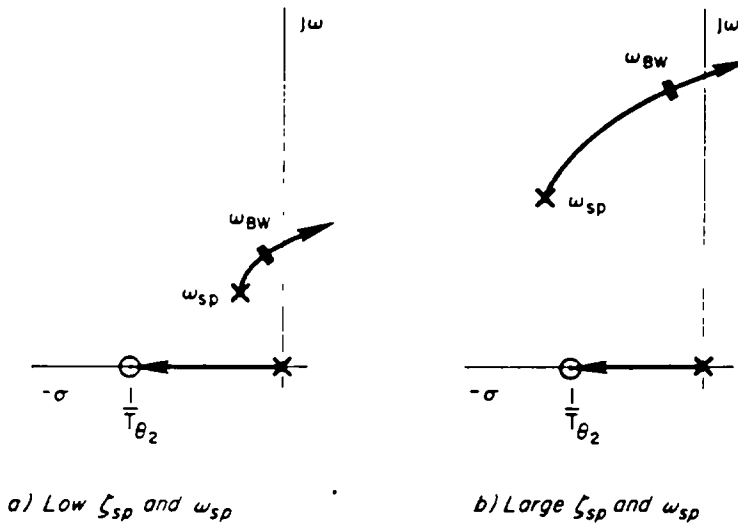
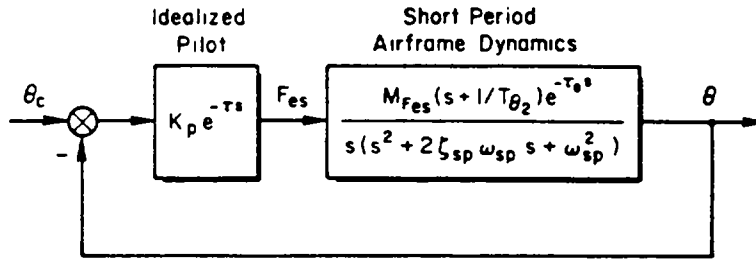

FIGURE 58. Simplified pilot-vehicle closure for pitch control.

If $\omega_{BW} = \omega_{BW_{gain}}$, the system is said to be gain-margin limited; that is, the aircraft is driven to neutral stability when the pilot increases his gain by 6 dB (a factor of 2). Gain-margin-limited aircraft may have a great deal of phase margin, Φ_M , but then increasing the gain slightly causes a large decrease in Φ_M . Such systems are characterized by frequency-response amplitude plots that are flat, combined with phase plots that roll off rapidly, such as shown in figure 59.

Several sets of data were correlated with bandwidth using the above definition. A typical result is shown in figure 60 utilizing the data from AFFDL-TR-70-74. While there is a definite pilot rating trend with ω_{BW} , the scatter for bandwidths between 2 and 6 rad/sec does not allow a quantitative definition of flying quality levels. A detailed analysis of the pilot/vehicle closure characteristics was made for Configurations 1D and 2I, to determine why these two configurations with nearly equal ω_{BW} would have such a large difference in pilot ratings (4 and 8 respectively). The detailed pilot/vehicle closures are shown in figures 61a and 61b. The value of bandwidth is seen to be about the same for both cases. However, if the pilot were to track very aggressively by further increasing his gain he could increase the bandwidth of configuration 1D greatly

MIL-STD-1797A
APPENDIX A

without adding much pilot compensation. Configuration 2I, though, offers a much more modest possibility) of increasing bandwidth (compare the root loci in figures 61a and 61b). This behavior is predictable from the phase curves: configuration 1D has a phase curve that rolls off very gradually at frequencies above ω_{BW} , whereas the phase for 2I drops off rapidly as the frequency is increased above ω_{BW} . It is not surprising that this case (2I) received a poor pilot rating (PR = 8) considering that attempts at aggressive tracking result in a closed-loop divergence. A steeper phase dropoff means less ability to increase bandwidth unless lead is added, or less increase in bandwidth for a given increase in pilot lead. Hence we have evidence that the ability of the pilot to attain good closed-loop regulation without threatening stability depends not only on

- 1) The value of bandwidth, ω_{BW} ,

but also on

- 2) The shape of the phase curve at frequencies above ω_{BW} .

Rapid rolloffs in phase are well represented by a pure time delay, $e^{-j\omega\tau}$. Since that represents a phase contribution of just $-\omega\tau$, both of the key factors noted above will be accounted for by plotting pilot rating data on a grid of ω_{BW} vs. τ . This is done for the AFFDL-TR-70-74 data (which were plotted versus ω_{BW} alone in figure 60) as shown on figure 62. The scatter is seen to be considerably reduced and the data are reasonably well separated into Level 1, 2, and 3 regions. The values of τ used in this plot were obtained from lower-order equivalent system fits of the higher-order system transfer functions (MDC Rpt A6792) The lower-order equivalent system form was:

$$\frac{\theta}{F_{es}} = \frac{K_{\theta} (s + 1/T_{\theta 2}) e^{-\tau_e s}}{s [s^2 + 2\zeta_e \omega_e s + \omega_e^2]}$$

The zero $1/T_{\theta 2}$ was fixed at the aircraft value (see earlier discussion of equivalent systems). But the bandwidth criterion is intended to avoid the need for an equivalent system match. A workable and much simpler approach is to note that to the extent that the rolloff in θ/F_s phase beyond -180 deg can be attributed to τ_e , we can estimate τ_e in the vicinity of some higher frequency ω_1 (and associated phase ϕ_1), from:

$$\tau_p = \frac{-\phi_1 - 180^\circ}{57.3 \omega_1}$$

where ω_1 is some frequency greater than the frequency for neutral stability³ and the symbol τ_p represents the estimate of τ_e . Correlations between τ_e and τ_p for the combined AFFDL-TR-70-74 and AFFDL-TR-78-122 data resulted in a correlation coefficient of 0.96. Thus, there is very good evidence that τ_p can be used in place of τ_e in figure 62, as will be shown in Supporting data.

³ ω_1 was taken as twice the neutral stability frequency, i.e. $\omega_1 = 2\omega_{180}$. Hence $\tau = -(\phi_{2\omega_{180}} + 180^\circ)/(57.3 \times 2\omega_{180})$. At the frequency $2\omega_{180}$, structural or other modes may complicate analysis, thus making application of this requirement difficult.

MIL-STD-1797A
APPENDIX A

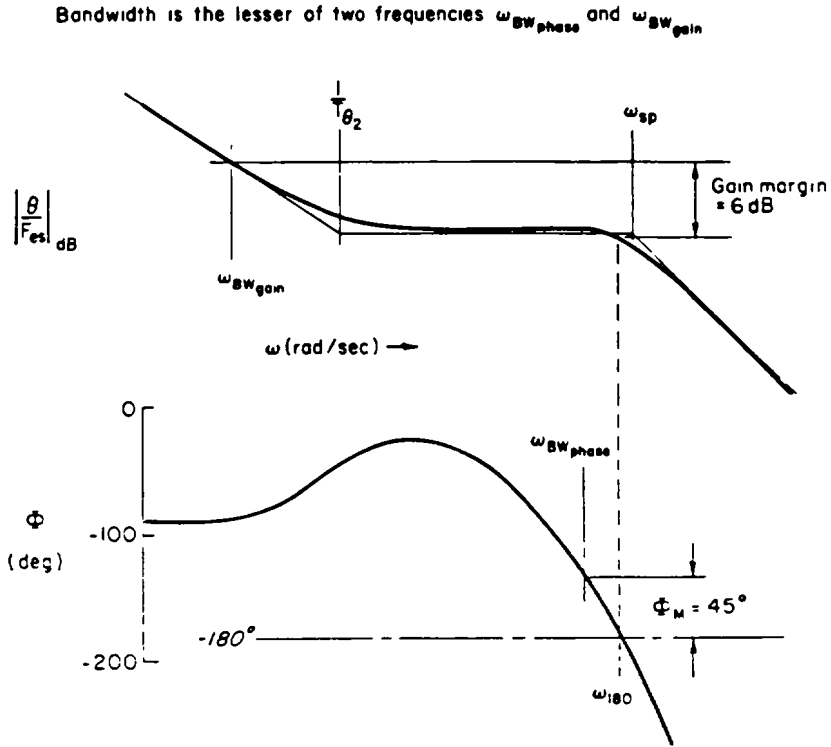

FIGURE 59. Definition of bandwidth frequency ω_{BW} from open loop frequency response.

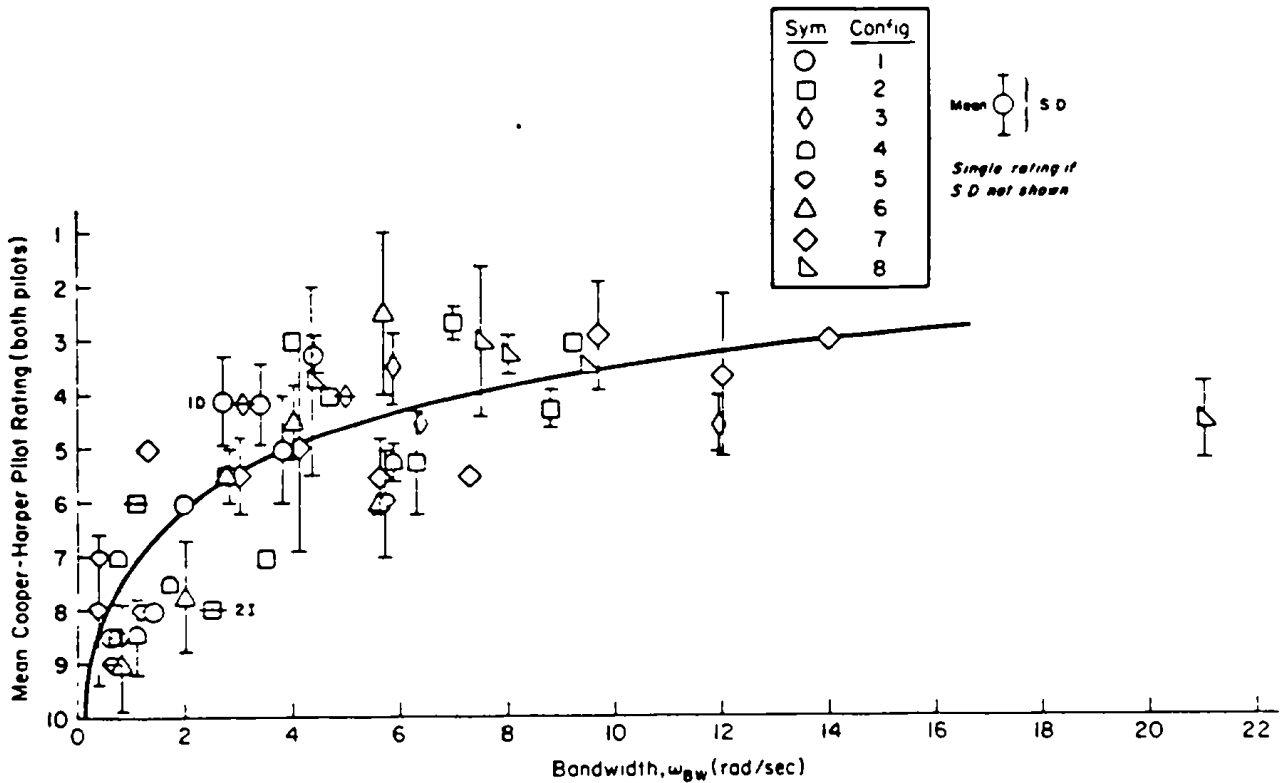

FIGURE 60. Comparison of Neal-Smith data (AFFDL-TR-70-74) with bandwidth (mean ratings).

MIL-STD-1797A
APPENDIX A

MIL-STD-1797A
APPENDIX A

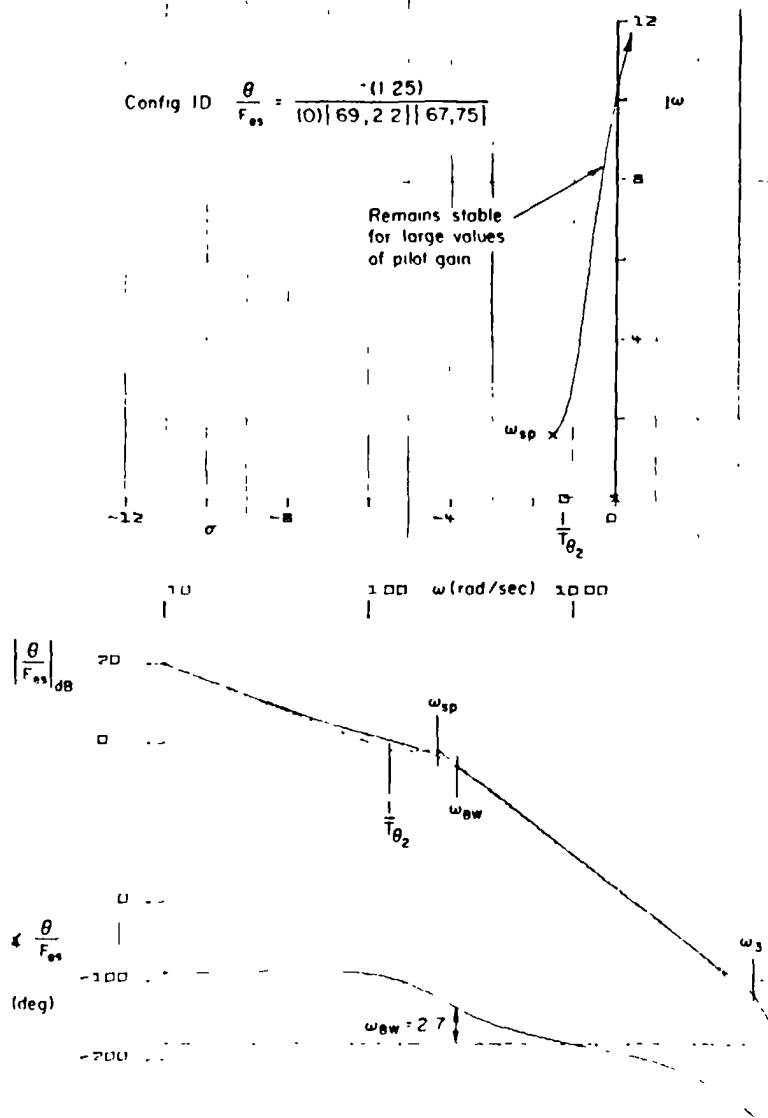

FIGURE 61a. Level 1/2 system of Neal-Smith (1D): $\omega_{BW} = 2.7$ rad/sec, mean PR = 4.1.

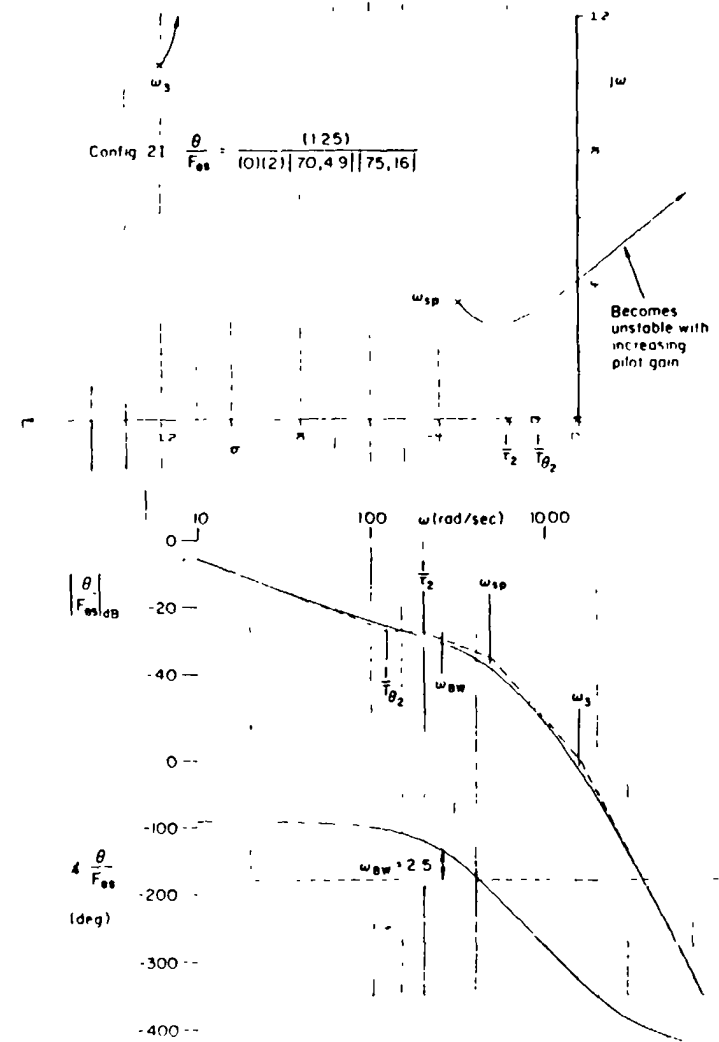

FIGURE 61b. Level 3 system of Neal-Smith (2I) $\omega_{BW} = 2.5$ mean PR = 8.0.

MIL-STD-1797A
APPENDIX A

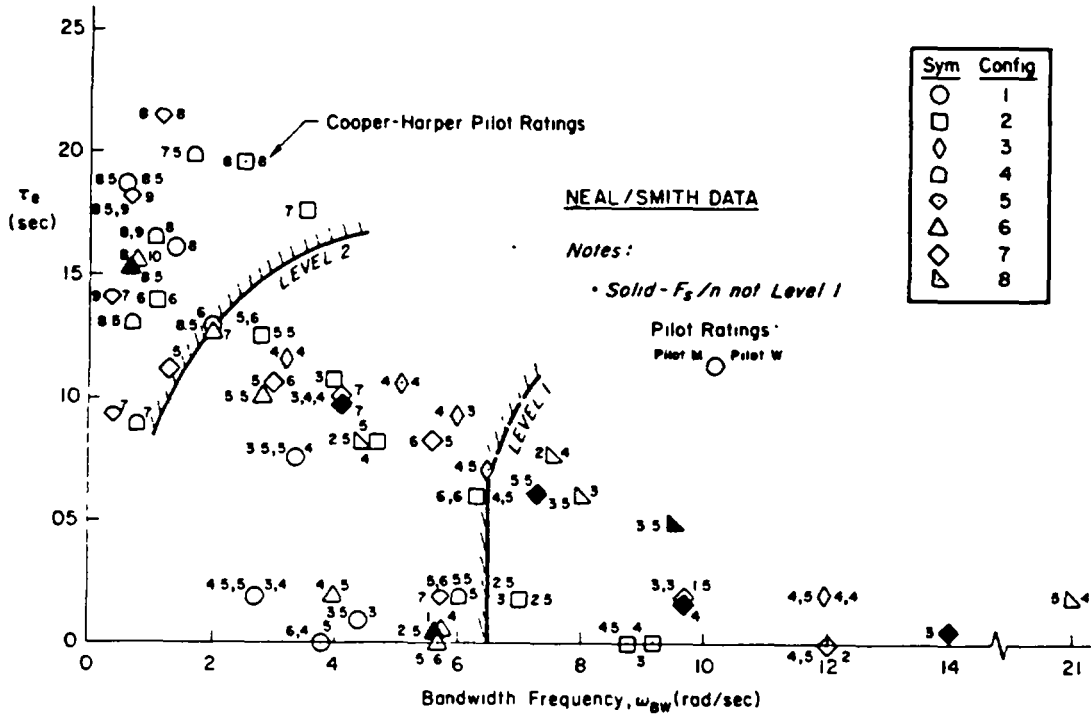

FIGURE 62. Correlation of pilot ratings with ω_{BW} and τ_e (AFFDL-TR-70-74 data).

Responses that are gain-margin-limited tend to have shelf-like amplitude plots as shown on figure 63. With such systems a small increase in pilot gain results in a large change in crossover frequency and a corresponding rapid decrease in phase margin. The decrease in phase margin becomes critical for attitude control when τ_p is moderately large (of order 0.1 to 0.2). The two configurations shown on figure 63 are taken from the AFFDL-TR-78-122 experiment. Applying the previously discussed definition of bandwidth, we find that both Configurations 5-6 and 5-7 are pin-margin-limited. Both configurations suffer from the same deficiency, i.e., moderate values of τ_e combined with a shelf-like amplitude curve that results in a very rapid decrease in phase margin with small changes in pilot gain. However, the 6 dB limit selected to define $\omega_{BW_{gain}}$ does not catch Configuration 5-6. While this configuration is correctly predicted to be Level 2 (PR = 6) on the basis of τ_p , the value of ω_{BW} is in the Level 1 region. Had a slightly higher value of gain margin been picked to define ω_{BW} , the bandwidths for Configurations 5-6 and 5-7 would be approximately equal. However, because of the nature of shelf-like frequency responses, there will always be a case which can fool the criterion. An experienced handling qualities engineer would immediately recognize the shelf-like shape and moderate τ_p as a significant deficiency. However, the purpose of a criterion is to eliminate such judgement calls. Nonetheless, it is not expected that this idiosyncrasy will result in problems with correlating or predicting pilot rating data inasmuch as moderate (Level 2) values of τ_p are required to get misleading values of ω_{BW} (i.e., rapid phase rolloff in a frequency region where the amplitude curve is flat must occur to get the effect shown on figure 63).

Supporting data

The data from Neal-Smith (AFFDL-TR-70-74) are compared with the bandwidth Category A requirements on figure 64. Some points with discrepancies between the rating and the LOES criteria [table

MIL-STD-1797A
APPENDIX A

XIII] are filled in on figure 64. The bandwidth criteria correctly evaluate three or four of these five points. These results are reasonably encouraging, though there are a number of Level 2 ratings at high values of bandwidth. The abbreviated pilot comments (taken from AFFDL-TR-70-74 and AFFDL-TR-74-9) indicate that abruptness and oversensitivity become a problem when ω_{BW} is large. This was especially true of the AFFDL-TR-74-9 pilot ratings (given in parentheses on figure 64). A possible boundary on ω_{BW} is shown on figure 64 to account for this problem. This boundary is considered tentative because the issue of overresponsiveness is not completely understood at this time. A broader data base is felt to be necessary to verify the results concerning an upper limit on ω_{BW} , so this is indicated by a broken line on figure 57.

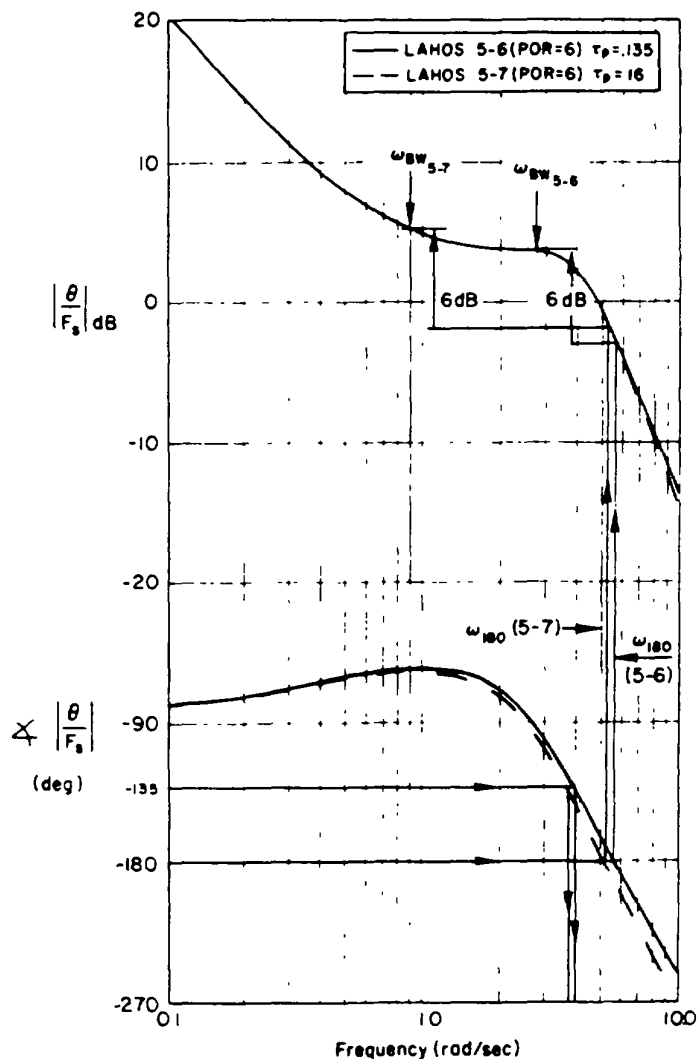

FIGURE 63. Large difference in bandwidth due to shelf in amplitude plot with moderate values of τ_p (configurations of AFFDL-TR-78-122).

MIL-STD-1797A
APPENDIX A

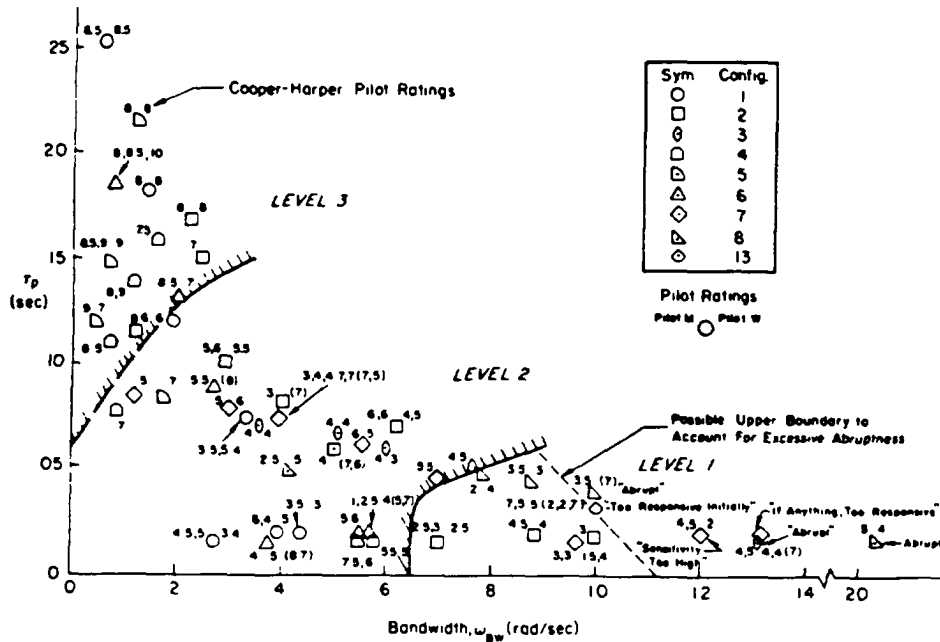

FIGURE 64. Correlation of pilot ratings with ω_{BW} and τ_p for Neal-Smith data (Category A) (data from AFFDL-TR-70-74, ratings in parentheses from AFFDL-TR-74-9).

The evaluation maneuvers performed in the Neal-Smith study included a pitch-bar tracking test but did not have an actual air-to-air tracking task. When tracking a target aircraft there is some suggestion of acceptance of abruptness. For example, Configuration 13 in the AFFDL-TR-70-74 experiments was rated 7 and 5.5 due to excessive sensitivity. However, in a follow-on experiment (AFFDL-TR-74-9) with a target aircraft, Configuration 13 was rated a 2 on two separate evaluations. At first glance this would seem to be an idiosyncrasy of different pilots in a different experiment; but during a repeat experiment, the target aircraft was removed and the rating went from 2 back up to 7 (see \diamond on figure 64).

The data correlations on figure 64 represent up-and-away flight, and so are appropriate for generating boundaries for Category A. Data (AFFDL-TR-78-122) for Category C (approach and landing) are correlated with ω_{BW} and τ_p on figure 65. The upper boundary on (ω_{BW} for Level 1 is considered tentative for the reasons discussed above.

The bandwidth criterion was developed for highly augmented aircraft, and the data shown in its support have been for high-order systems. Figure 66 and 67 compare bandwidths of classical (unaugmented) airplanes with pilot ratings obtained in flight simulations. For AFFDL-TR-66-63, AFFDL-TR-68-91, Princeton University Rpt 777, and AFFDL-TR-69-3, the test vehicle was the USAF/CALSPAN T-33, for which $\tau_p = 0.07$ sec (due to actuation and feel systems); τ_p for the NASA-TN-D-3971 data, a Boeing 367-80, is not known but is assumed to be about the same.

The classical-airplane data agree rather well with the Level 2 and 3 boundaries, but for both Categories A and C the Level 1 boundary of figure 57 appears too stringent. (For example, in Category A flight, figure 57a does not allow τ_p greater than about 0.06 sec for Level 1, therefore all the figure 65 data (for $\tau_p = 0.07$) should be rated Level 2 or worse. The data, however, tend to support a Level 1 boundary at $\omega_{BW} = 4$ rad/sec, as shown by the dashed line. No rating worse than 4-1/2 was given for $\omega_{BW} > 4$. The reasons for

MIL-STD-1797A
APPENDIX A

this disagreement have not been resolved, though the task used for evaluation, as discussed earlier, may not have been tight enough to provoke pilot objections to response abruptness or to excessive time delays.

No supporting data are available at this time to establish Category B boundaries.

Somewhat unstable configurations, with no bandwidth at all, can be flown quite safely (see discussion of Level 3 requirements in Supporting data). Therefore, for statically unstable aircraft the Level 3 requirement stated earlier should be applied.

Reaction to these bandwidth criteria for pitch response has been mixed. While some have had moderate or even better success with it, others comment that a) the criteria do not predict flying qualities Levels correctly; b) the bandwidth criteria exclude some of the Level 1 CAP area, and vice versa; c) there are cases in which τ_p is not close to τ_e , and d) path control is not addressed. Nevertheless, because of the success cited we recommend using bandwidth along with other criteria.

For Level 3, see the discussion in section A and the supporting data in section B.

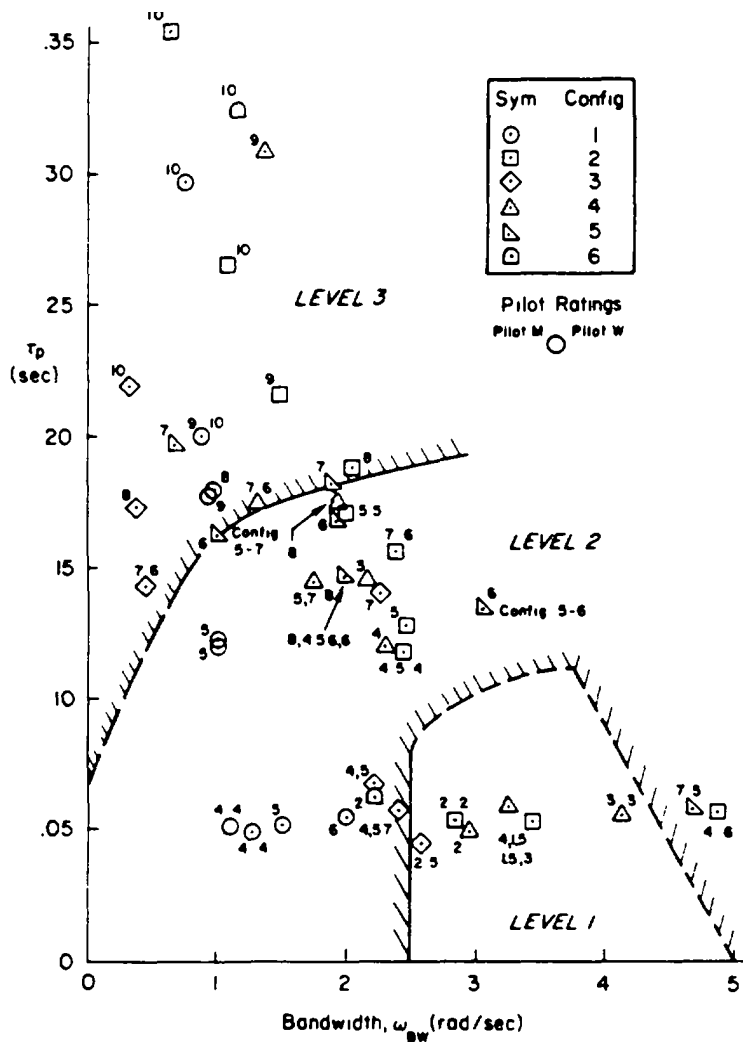
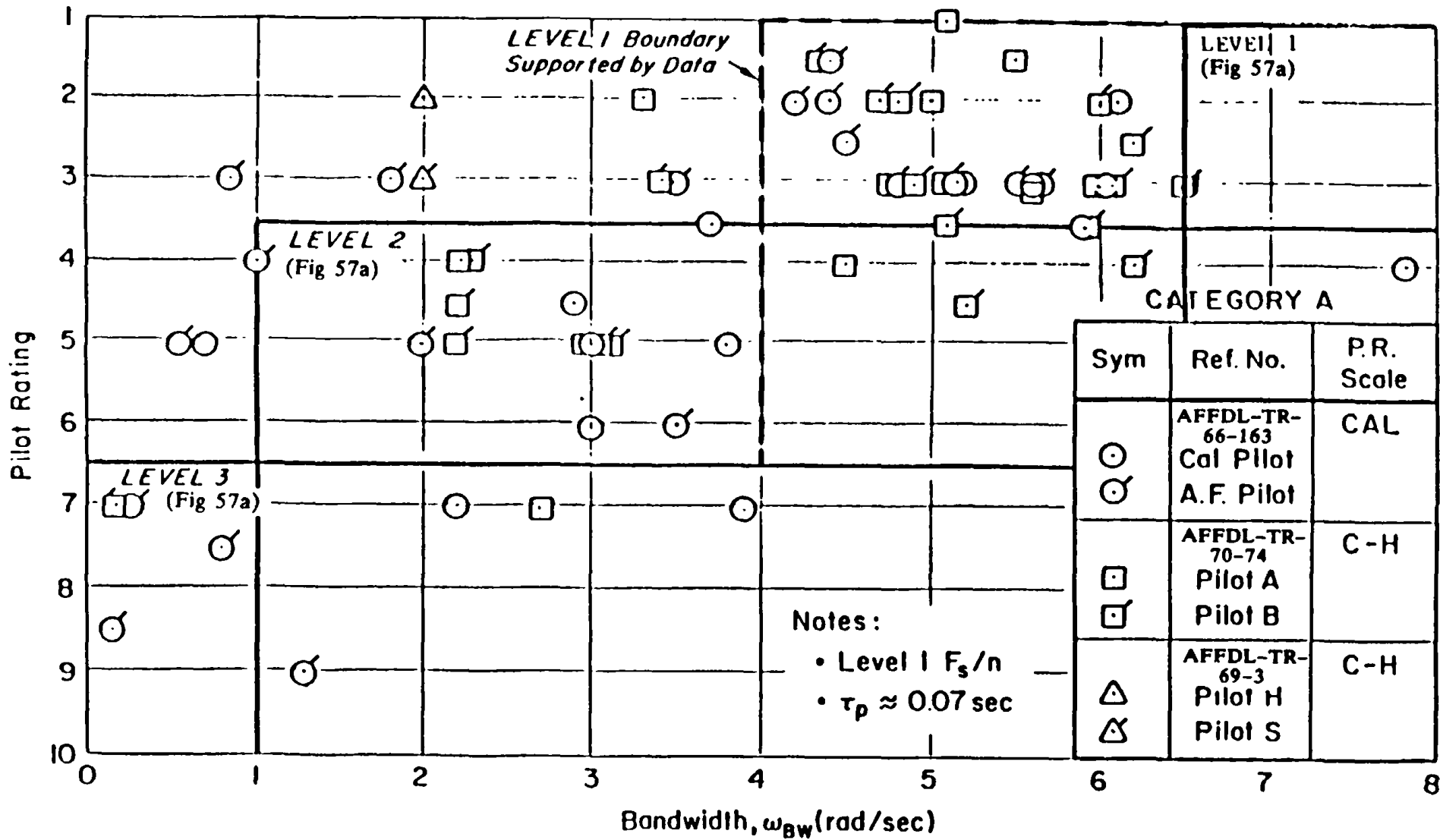

FIGURE 65. Correlation of pilot ratings with ω_{BW} and τ_p for approach and landing (AFFDL-TR-122).

MIL-STD-1797A
APPENDIX A



MIL-STD-1797A
APPENDIX A

FIGURE 66. Comparison of pilot ratings for Category A short-period configurations with bandwidth (classical airplanes).

MIL-STD-1797A
APPENDIX A

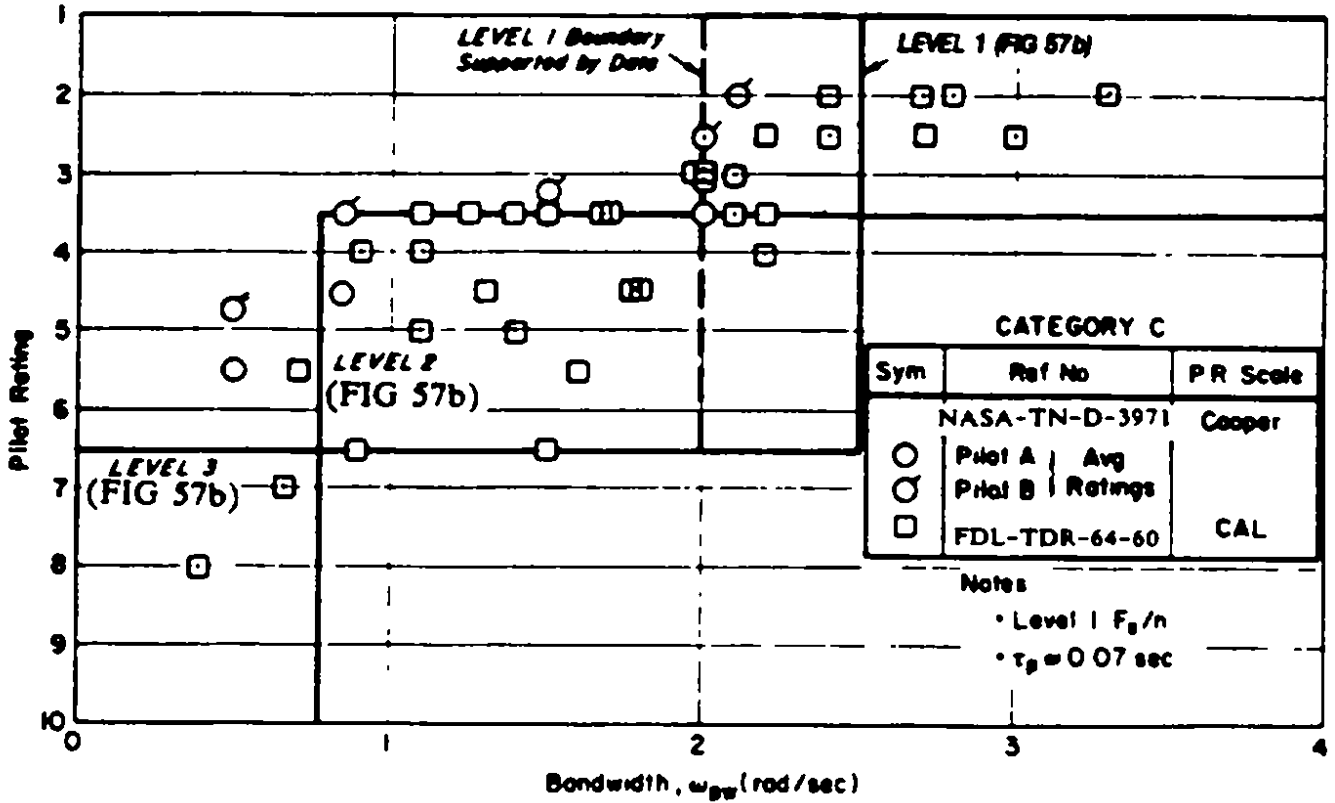
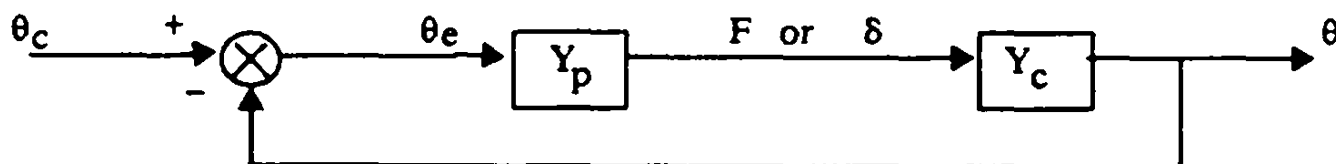

FIGURE 67. Comparison of pilot ratings for Category C short-period configurations with bandwidth (classical airplanes).

MIL-STD-1797A
APPENDIX A

E. Closed-Loop Criterion

For pilot control of pitch attitude in the manner sketched,



where Y_c is the transfer function of the aircraft and flight control system, θ_c is an external pitch command, θ_e is pitch attitude error, F is pilot force on the pitch controller, δ is its deflection and Y_p is the analytical pilot model (either form is permitted):

$$Y_p = K_p e^{-.25s} \frac{(T_{p1}s + 1)}{(T_{p2}s + 1)} \quad \text{or} \quad K_p e^{-.25s} \frac{(5s + 1)}{s} \frac{(T_{p1}s + 1)}{(T_{p2}s + 1)}$$

a bandwidth, defined by a closed-loop phase of -90 degrees, of

FLIGHT PHASE	BANDWIDTH
Category A	3.5 rad/sec
Category B	1.5 rad/sec
Landing	2.5 rad/sec
Other Category C	1.5 rad/sec

shall be attainable with closed-loop droop no more than -3 dB for Levels 1 and 2 and closed-loop resonance no greater than 3 dB for Level 1, 9 dB for Level 2 over the frequency range from 0 to 10 rad/sec. The pilot model is constrained to the given forms but there are no limits on K_p , T_{p1} or T_{p2} . The requirements apply for both force and deflection pilot control inputs. Figure 68, in the form of a Nichols chart, illustrates these limits. The pilot output is force for force controllers (pilot controller force commands the control effectors) and deflection for deflection controllers (pilot controller deflection commands the control effectors).

For Level 3, T_2 , the time to double amplitude based on the value of the unstable root, shall be no less than 6 seconds. In the presence of any other Level 3 flying qualities, ζ_{sp} shall be at least 0.05 unless flight safety is otherwise demonstrated to the satisfaction of the procuring activity. T_2 applies to the value of the unstable root: $T_2 = -(\ln 2)/\lambda$ where λ is the value of the unstable root.

The criteria contained in this paragraph are intended to ensure good dynamic performance capability of the pilot-aircraft dynamic system. The form in which the criteria are stated was selected to permit accommodation of highly augmented aircraft and systems with transport time delay or cascaded dynamic elements. Through application of describing function techniques, the criteria may also permit investigation of the effects of certain nonlinearities typically encountered in flight control systems.

MIL-STD-1797A
APPENDIX A

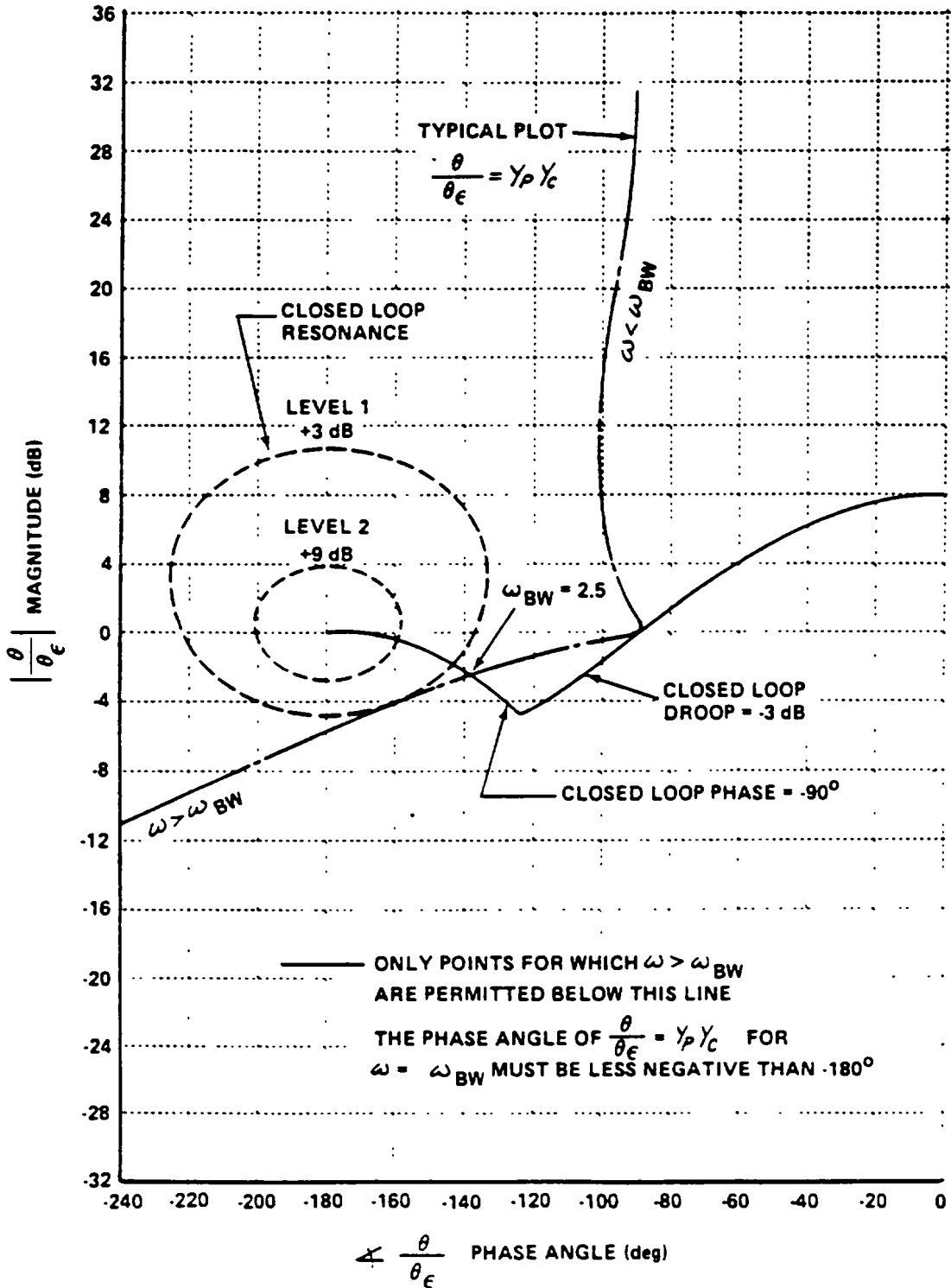

FIGURE 68. Design criteria for pitch dynamics with the pilot in the loop.

MIL-STD-1797A
APPENDIX A

The criteria as modified by Chalk (NASA-CR-159236) are derived from the work by Neal and Smith reported in AFFDL-TR-70-74. The basic approach is to model the pilot-aircraft pitch attitude control loop as a unity-feedback system with a pilot model of an assumed form in the forward loop. The form of the assumed pilot model permits accounting for the following characteristics exhibited by pilots when controlling dynamic systems:

- Adjustable gain.
- Time Delay
- Ability to develop lead, or to operate on derivative or rate information.
- Ability to develop lag, or to smooth inputs
- Ability to provide low-frequency integration

Neal and Smith's original version also placed limits on phase compensation in the pilot model.

The two forms of the pilot model account for the observed capabilities and limitations of the pilot with sufficient accuracy to permit approximate analysis of the dynamics of the closed-loop pilot-aircraft system in pitch. It should be emphasized that the pilot model need not be an exact analog of the human pilot in order to be useful in the context of design criteria. The criteria are based on the hypothesis that if good closed-loop dynamic performance can be achieved with an autopilot with the characteristics described by the assumed pilot model, then the human pilot will also be able to achieve good closed-loop dynamic performance with acceptable workload.

These two forms differ by the $(5s + 1)/s$ term, the low-frequency integration capability. It is intended that the form of the model without this term will be used when constant speed or two-degree-of-freedom equations are used to represent the aircraft. In this case the aircraft transfer function should have a free s in the denominator and low-frequency integration by the pilot will not be necessary. When three-degree-of-freedom equations are used or when the flight control system uses attitude stabilization ("Aircraft Dynamics and Automatic Controls"), it may be necessary for the pilot model to perform low-frequency integration to avoid droop at frequencies less than ω_{BW} .

The $e^{-.25s}$ term in the pilot model accounts for time delay in the pilot's neuromuscular system. The value of 0.25 sec. is based on delays observed in records for the discrete tracking task performed in AFFDL-TR-70-74 and AFFDL-TR-78-122. These records exhibit delays ranging from 0.20 to 0.40 seconds. The value of 0.25, selected on the basis of cut-and-try data correlation, is interrelated with the bandwidth frequency that is specified for a given flight phase or task. The values of time delay (0.25 sec) and bandwidth ($\omega_{BW} = 2.50$ rad/sec) for the landing Flight Phase have been determined from empirical correlation of data in AFFDL-TR-72-143 and AFFDL-TR-78-122.

Because the closed-loop pilot-aircraft dynamic system has been modeled as a negative feedback system with unity gain in the feedback path, it is possible to relate the dynamic characteristics of the elements in the forward loop, $\theta/\theta_e = Y_p Y_c$, to the dynamic characteristics of the closed-loop system, $\theta/\theta_c = Y_p Y_c / (1 + Y_p Y_c)$, through use of a Nichols chart. This diagram consists of the superposition of two grid systems. The rectangular grid is the magnitude and phase of the forward-loop dynamic system, $Y_p Y_c$, while the curved grid system represents the magnitude and phase of the closed-loop system, $\theta/\theta_c = Y_p Y_c / (1 + Y_p Y_c)$. Therefore one can determine the closed-loop dynamic characteristics by plotting the magnitude and phase of $Y_p Y_c$ over a range of frequency on the rectangular grid.

It is hypothesized that a given Flight Phase or task performed in a typical environment will require certain minimum dynamic characteristics of the closed-loop pilot-aircraft system. The parameters used to define

MIL-STD-1797A
APPENDIX A

the closed loop dynamic performance are bandwidth, droop at frequencies below the bandwidth and resonance magnitude. These closed-loop system parameters are defined by the curved lines on figure 68. The maximum droop permitted for $\omega < \omega_{BW}$ is -3.0 dB. This value has been defined somewhat arbitrarily but can be justified from examination of discrete tracking task records in AFFDL-TR-70-74 and AFFDL-TR-78-122 and by interpretation of pilot comments in these documents.

Hanke (AGARD-CP-333) relates the Neal-Smith criteria to $\omega_{sp}^2/(n/\alpha)$.

SUPPORTING DATA

The bandwidth frequency and the closed-loop system resonance limits for Level 1 and Level 2 have been determined from empirical data correlation, AFFDL-TR-70-74 and Radford and Smith in AFWAL-TR-80-3067.

It is not feasible to present all the data available in the literature as substantiation of these closed-loop criteria. Four configurations have been selected for presentation to illustrate characteristics of interest to designers.

NASA-CR-159236 selected configurations 12 and 13 from AFFDL-TR-72-143 to illustrate dynamics typical of these aircraft that might result from center of gravity variations. Configuration 13 is representative of a forward c.g. while Configuration 12 represents an extreme aft c.g. which results in an unstable real root with a time to double amplitude $T_2 = 2.1$ sec.

The $Y_p Y_c$ data for these two cases are plotted on figures 69 and 70. From the plot on figure 69 it is seen that it was possible to find K_p, T_{p1} values that would satisfy the design criteria for Level 1 for Configuration 13. This configuration was rated PR = 1-1/2, 2, 3 on three separate evaluations. The plot on figure 69 indicates, that it was not possible to find pilot compensation that would satisfy the Level 1 design criteria for Configuration 12. It was possible, however, to satisfy the Level 2 design criteria. The pilot ratings for Configuration 12, however, were PR = 10. To understand this rating, it is necessary to realize that to obtain the plot illustrated, the pilot would have to develop large values of T_{p1} and a very specific value of K_p . This means he must operate on pitch rate information and he must constantly close the control loop with very little variation in the pilot model parameters. Thus in reality there are more dimensions to the criteria than are explicitly indicated by this requirement. [A good aircraft is one for which the closed-loop performance is not critically dependent on the values of the pilot model parameters.] The open-loop divergence limit of 4.4.1 on time to double amplitude would identify Configuration 12 as an unacceptable design, i.e. the behavior of this aircraft with no pilot control is unacceptable.

Configurations 6-1 and 6-2 from AFFDL-TR-78-122 were selected in NASA-CR-159236 to illustrate the detrimental effects that can result from cascading dynamic elements in the flight control system. Configuration 6-1 had a second-order prefilter with $\omega_n = 4$ rad/sec and $\zeta = .7$. Attempts to land this configuration resulted in uncontrollable pilot-induced oscillations; pilot rating was 10. Removal of this second-order prefilter and substitution of a lead-lag prefilter, $(.06s + 1)/(.10s + 1)$, reduced the phase shift and resulted in greatly improved flying qualities which were given a pilot rating of PR = 2. Figure 71 illustrates that Configuration 6-1 would exhibit large resonance when compensated by the pilot to achieve $\omega_{BW} = 2.5$ rad/sec without violating the -3 dB droop constraint. Figure 72, the plot for Configuration 6-2, illustrates that the Level 1 design criteria can easily be met by adjustment of the pilot model parameters, for a range of values of K_p and T_{p1} ; thus the closed-loop performance of Configuration 6-2 is not critically dependent on specific values of the pilot model parameters. Pilot rating was 2.

MIL-STD-1797A
APPENDIX A

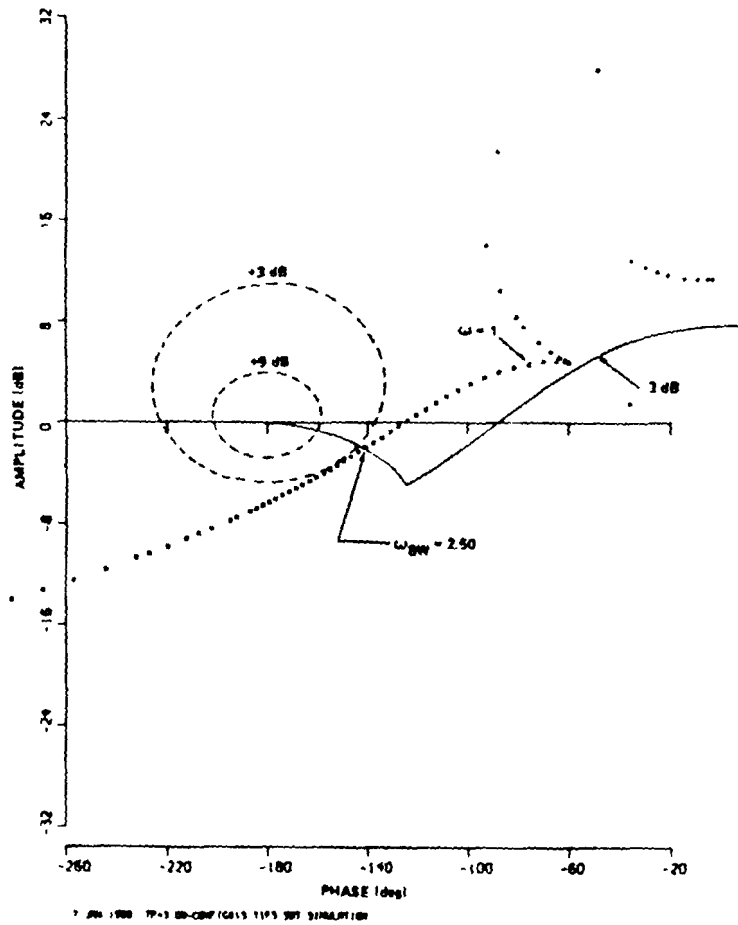

FIGURE 69. Amplitude-phase plot for configuration 13 (fwd; c.g.).

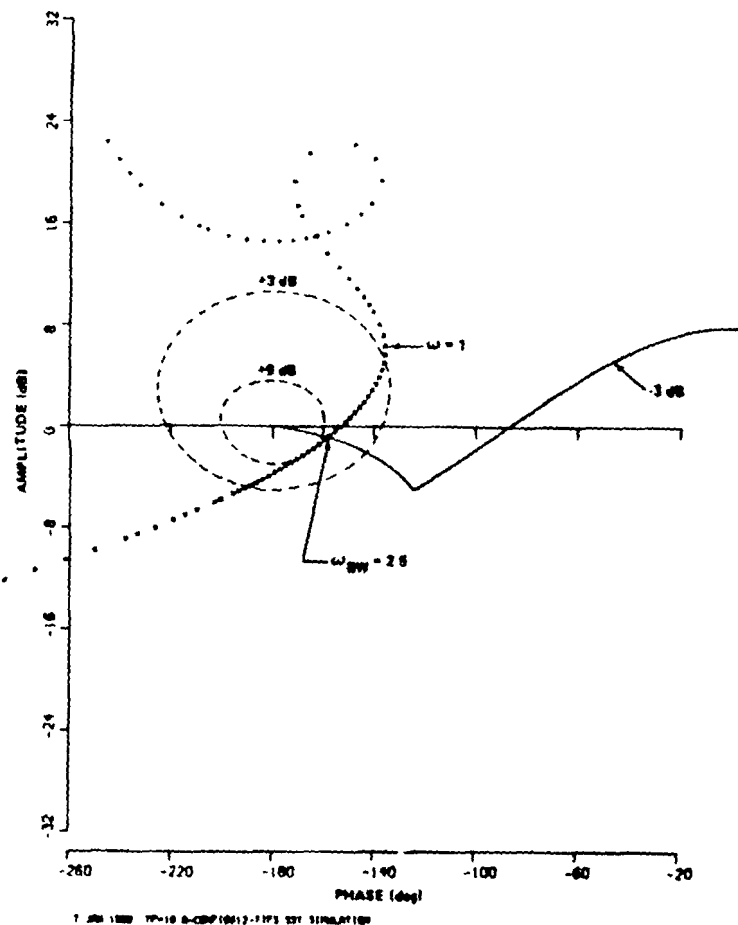

FIGURE 70. Amplitude-phase plot for configuration 12 (aft; c.g. - unstable).

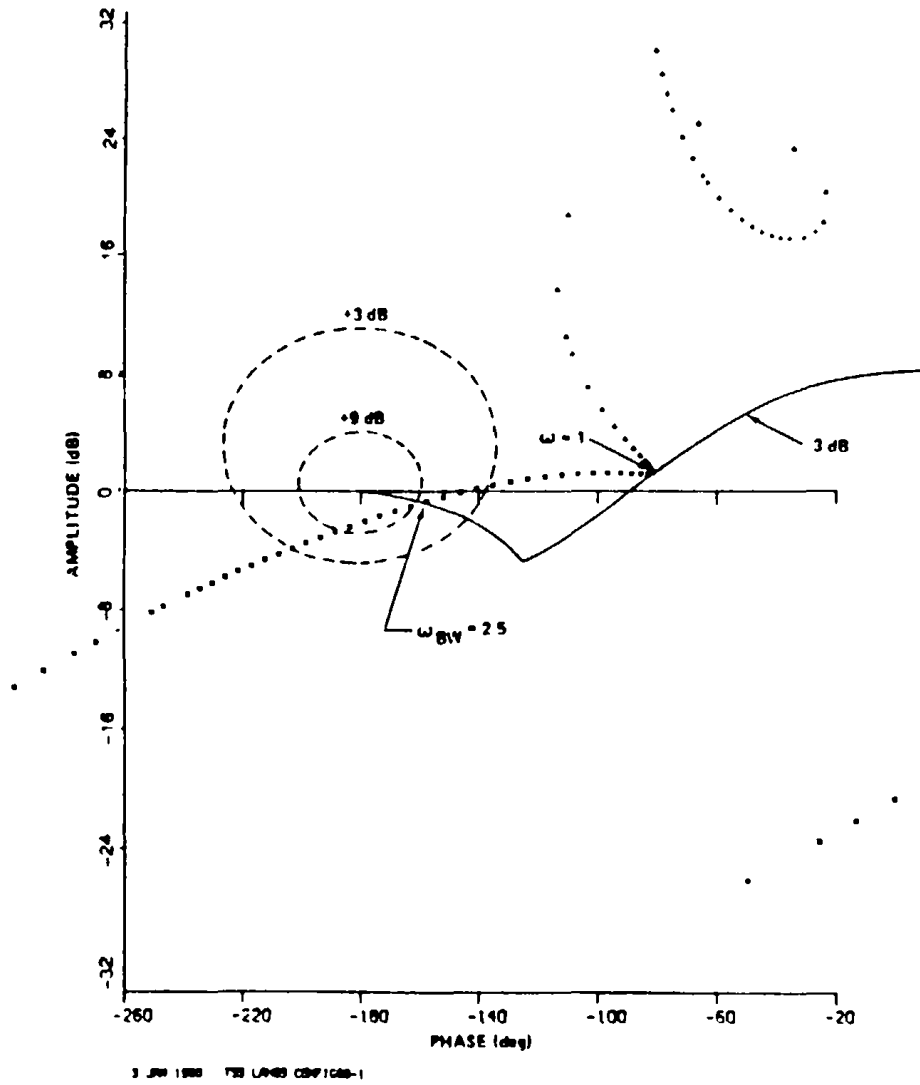

FIGURE 71. Amplitude-phase plot for configuration 6-1.

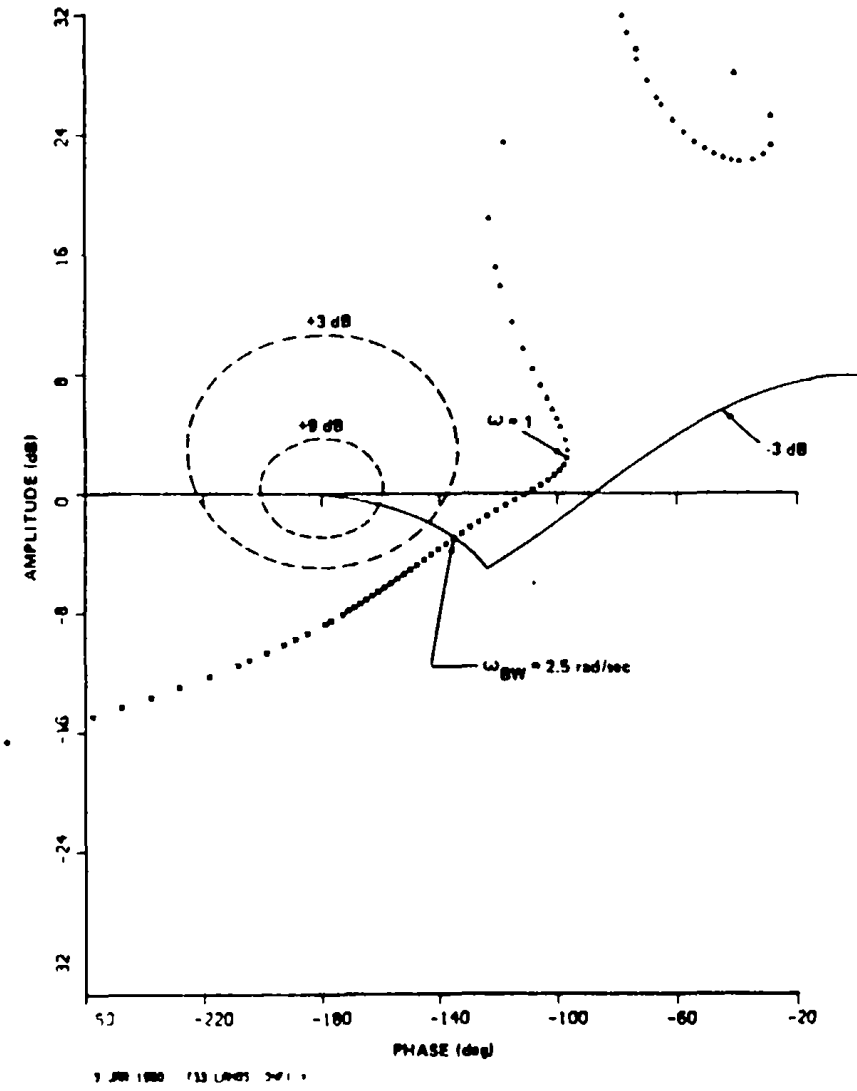

FIGURE 72. Amplitude-phase plot for configuration 6-2.

MIL-STD-1797A
APPENDIX A

Configurations 6-1 and 6-2 illustrate the degradation in flying qualities that can result from excessive phase shift in the pilot's command channel.

Although the Neal-Smith criteria account explicitly for pilot compensation, they may not always adequately account for sensitivity of closed-loop performance to the pilot-chosen bandwidth (see Radford and Smith in AFWAL-TR-80-3067).

Also note that the Neal-Smith criteria do not address path control at all; they examine only the pitch attitude loop. Additional criteria would seem necessary to assure adequate path control: perhaps $\omega_{sp}^2 / (n/\alpha)$ or $\omega_{sp} T_{\theta_2}$. Sarrafian (NASA-TM-86728) has used another variant of the Neal-Smith technique to correlate approach and landing data from two TIFS variable-stability airplane evaluation programs. He closed an inner pitch attitude loop, for all configurations, with the same amount of pilot phase compensation. Then closing an outer flight-path loop, he found that the achievable bandwidth correlated the pilot ratings.

For Level 3, see the discussion in section A and the supporting data in section B.

MIL-STD-1797A
APPENDIX A

F. Time- and frequency-response criteria by Gibson

The criteria based on the step input time response features shown on figure 73 are primarily related to attitude and flight path. They are intended for fly-by-wire control law design optimization and overall handling Levels 1, 2, and 3 have not been established.

a. For Category A and Category C Flight Phases, attitude dropback as defined on figure 73 should not normally be negative. Satisfactory values depend on the task and on the pitch rate transients.

b. Normal acceleration responses can be related to Level 1 frequency and damping requirements by the boundaries shown on figure 74. Any oscillations following the first peak should subside such that the ratio of successive half-cycles is less than 0.3.

c. Boundaries of satisfactory frequency responses for Category A precision attitude tracking are shown on figure 75. Responses outside the low-frequency limits with the handling tendencies indicated may be satisfactory for other tasks, as determined by time response limits.

d. An envelope of satisfactory Category C landing approach response for frequencies below the required bandwidth of 0.25 to .5 Hz at 120 degrees phase lag is shown on figure 75.

e. All frequency responses must satisfy the figure 75 requirements for response attenuation and phase lag rate of increase at the 180 degree phase lag crossover frequency.

The following discussion by Gibson is extracted from AGARD-CP-333 and ICAS-86-5.3.4. Figures 76 to 82 further illustrate these concepts and define his parameters.

USAF-Calspan in-flight simulations of pitch handling with high-order flight control systems, using their T-33 aircraft, have furnished a source of information about acceptable attitude and flight path characteristics. In AFFDL-TR-74-9 the tasks of air combat maneuvering, air-to-air tracking and flight refueling, and in AFFDL-TR-78-122 the approach and landing tasks were assessed for wide ranges of basic frequency and damping modified by stick prefilters to simulate high-order effects

Step responses were calculated for all these configurations and their features compared with pilot rating and comment data. Some quite clear results were obtained which can be summarized as follows.

- Negative attitude drop back (i.e. overshoot) was usually associated with sluggish, unpredictable response both in flight path control and in tracking, leading sometimes to overdriving PIO
- Attitude drop back from 0 to about 0.25 seconds was excellent for fine tracking and was associated with comments typified by the nose follows the stick.
- Increasing attitude drop back with large pitch rate overshoot led to abrupt response and bobbling, from slight tendency to continuous oscillations, in tracking tasks. Sometimes this was called PIO, but it did not cause concern for safety.
- Attitude drop back had little effect within the range tested upon gross maneuvering without target, landing approach or flight refueling, provided it was not negative.
- CAP up to 3.6 rad/sec²/g was satisfactory for gross maneuvering without a target, but was unsatisfactory above 2 rad/sec²/g for the landing approach, above 1 rad/sec²/g for fine tracking, and below 0.28 rad/sec²/g for any task.

MIL-STD-1797A
APPENDIX A

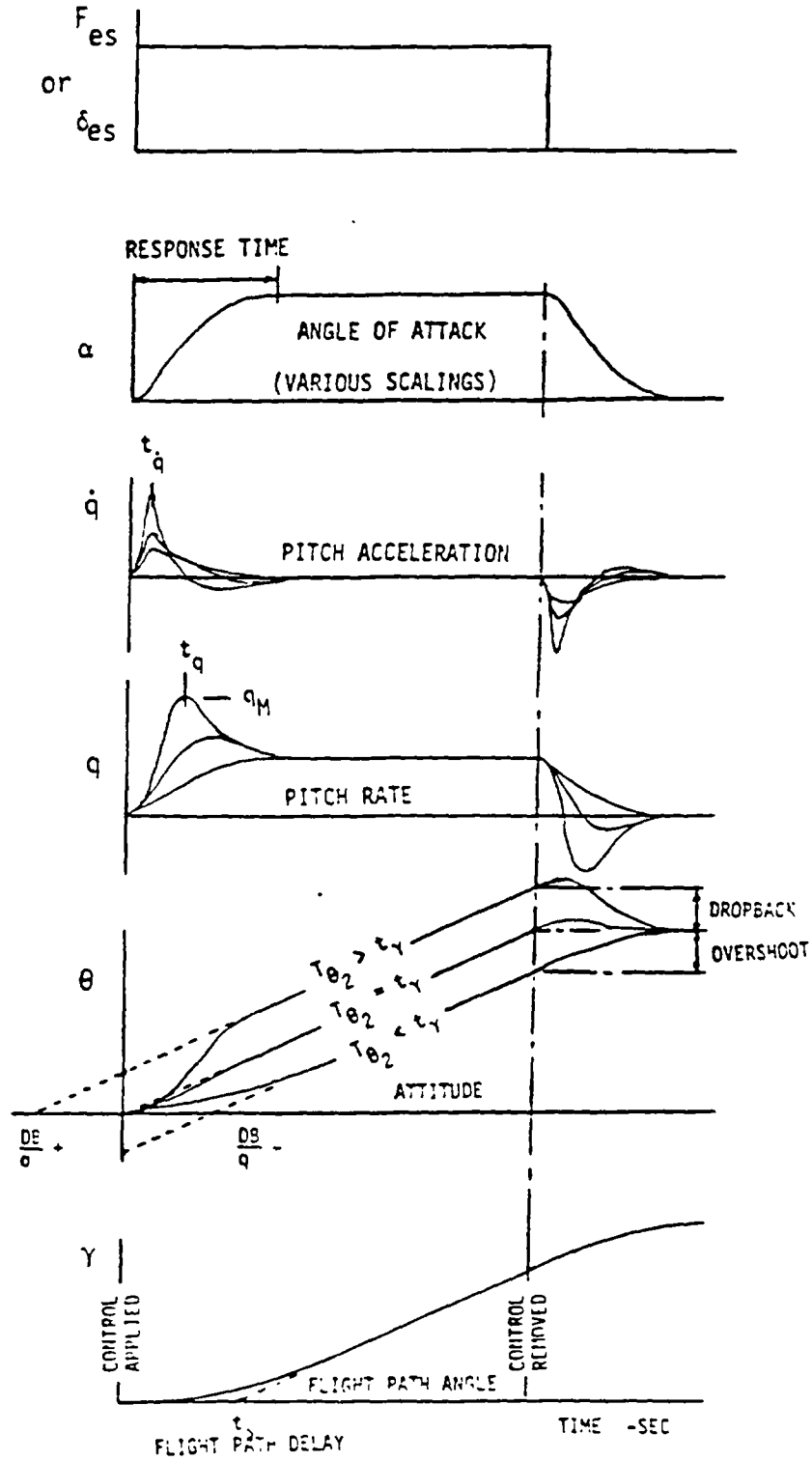

FIGURE 73. Pitch short period time responses.

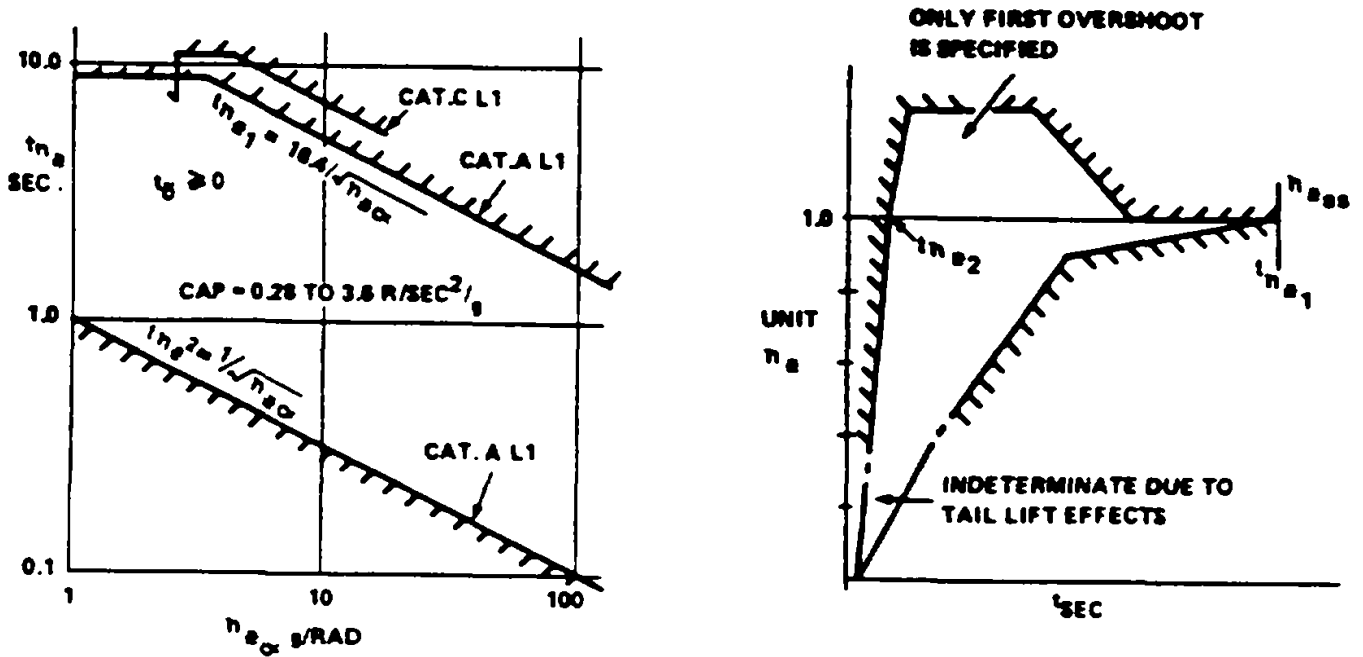

FIGURE 74. Equivalent ω_n boundaries.

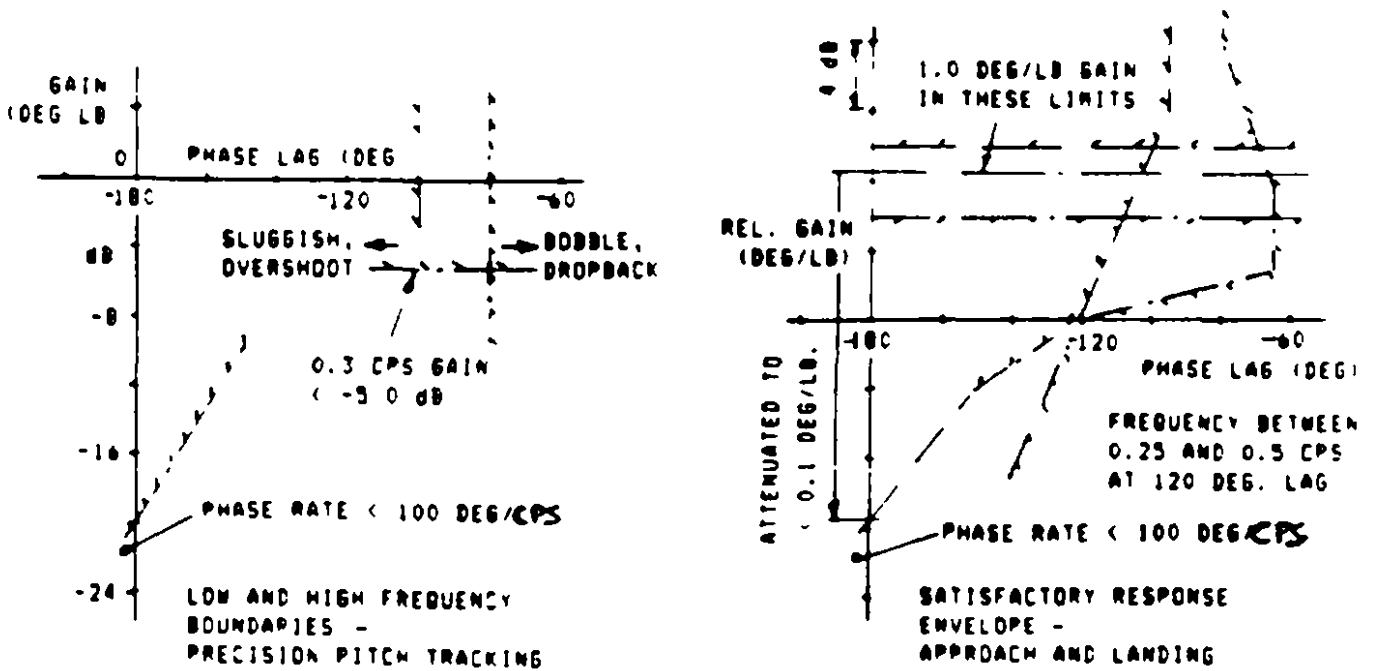

FIGURE 75. Design aim criteria for pitch attitude frequency response.

MIL-STD-1797A
APPENDIX A

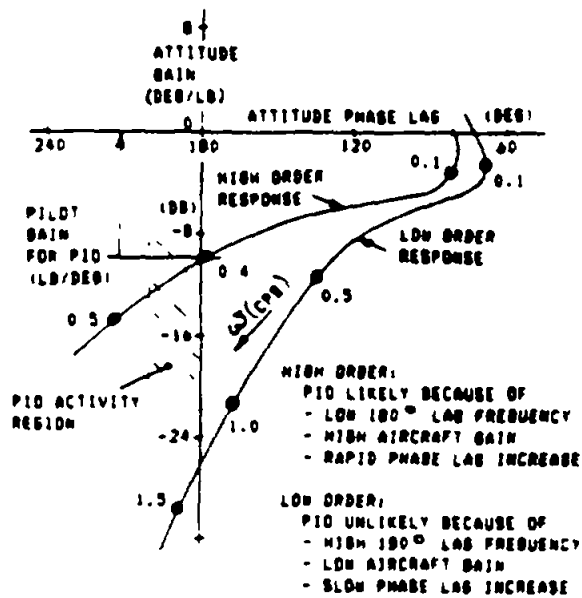

FIGURE 76. High and low order frequency response.

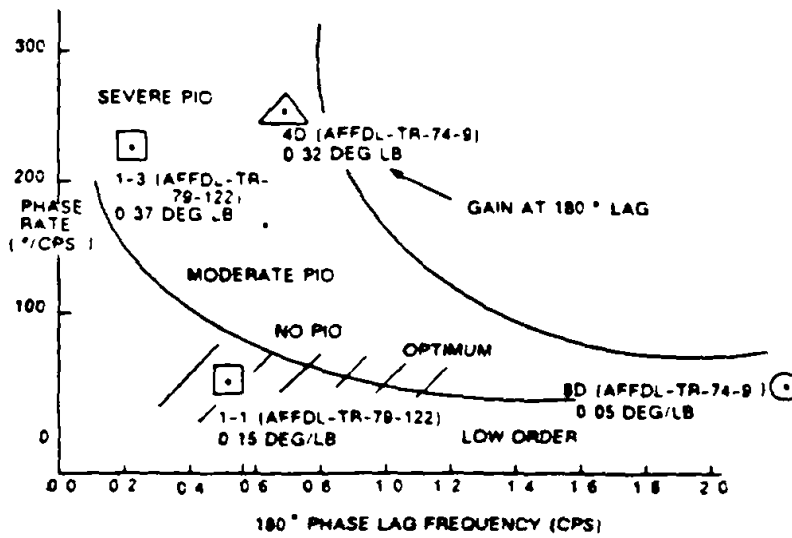

FIGURE 77. Trends of high order phase rate.

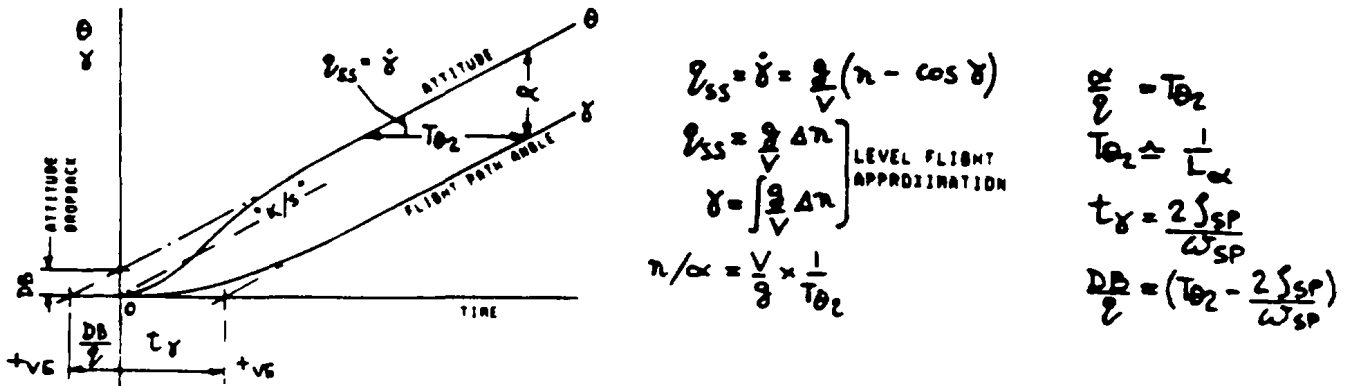

FIGURE 78. Flight path - attitude relationships.

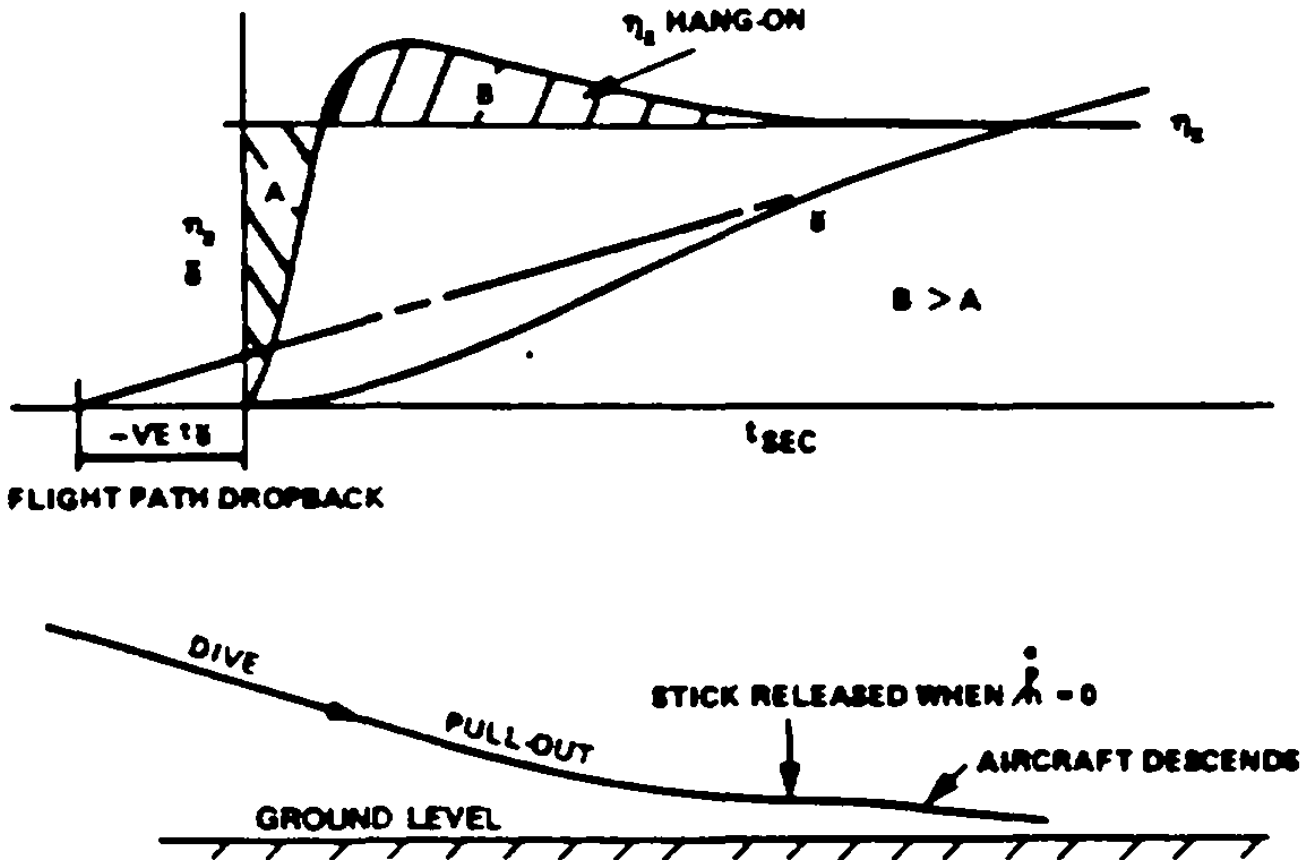

FIGURE 79. n_z hang-on effects.

MIL-STD-1797A
APPENDIX A

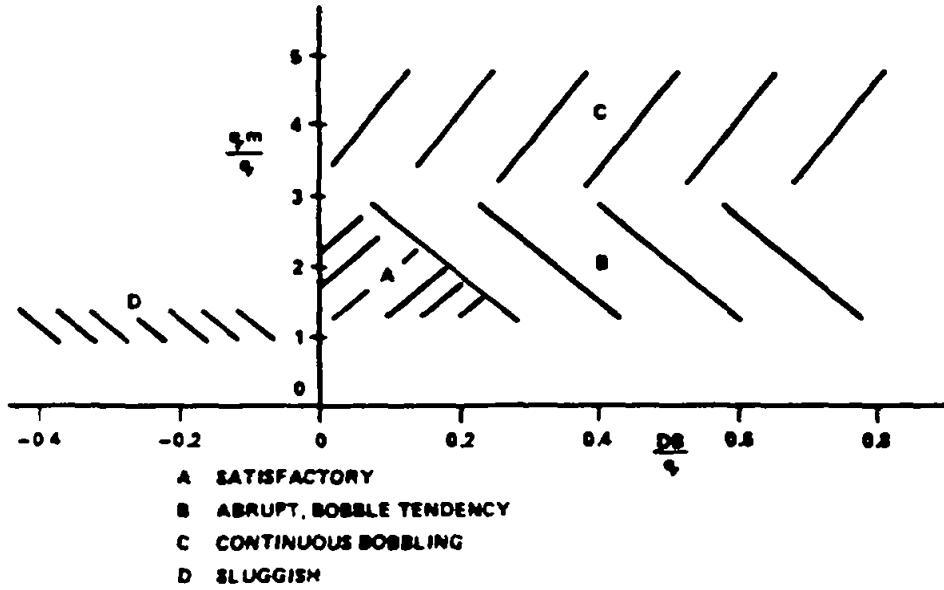

FIGURE 80. Precision tracking: $q \sim \theta$ trends.

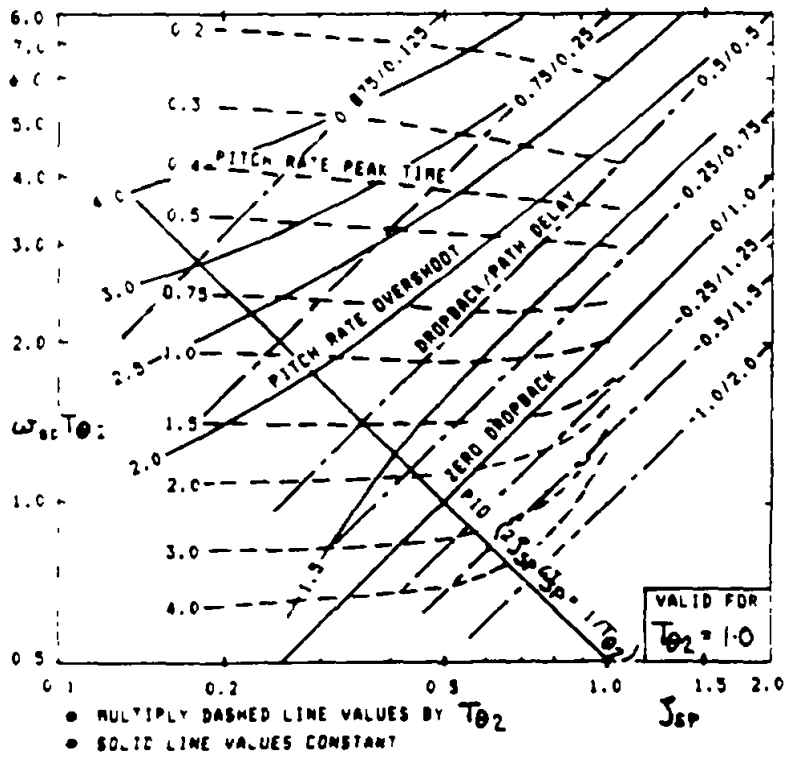

FIGURE 81. New short-period thumbprint (from ICAS-86-5.3.4).

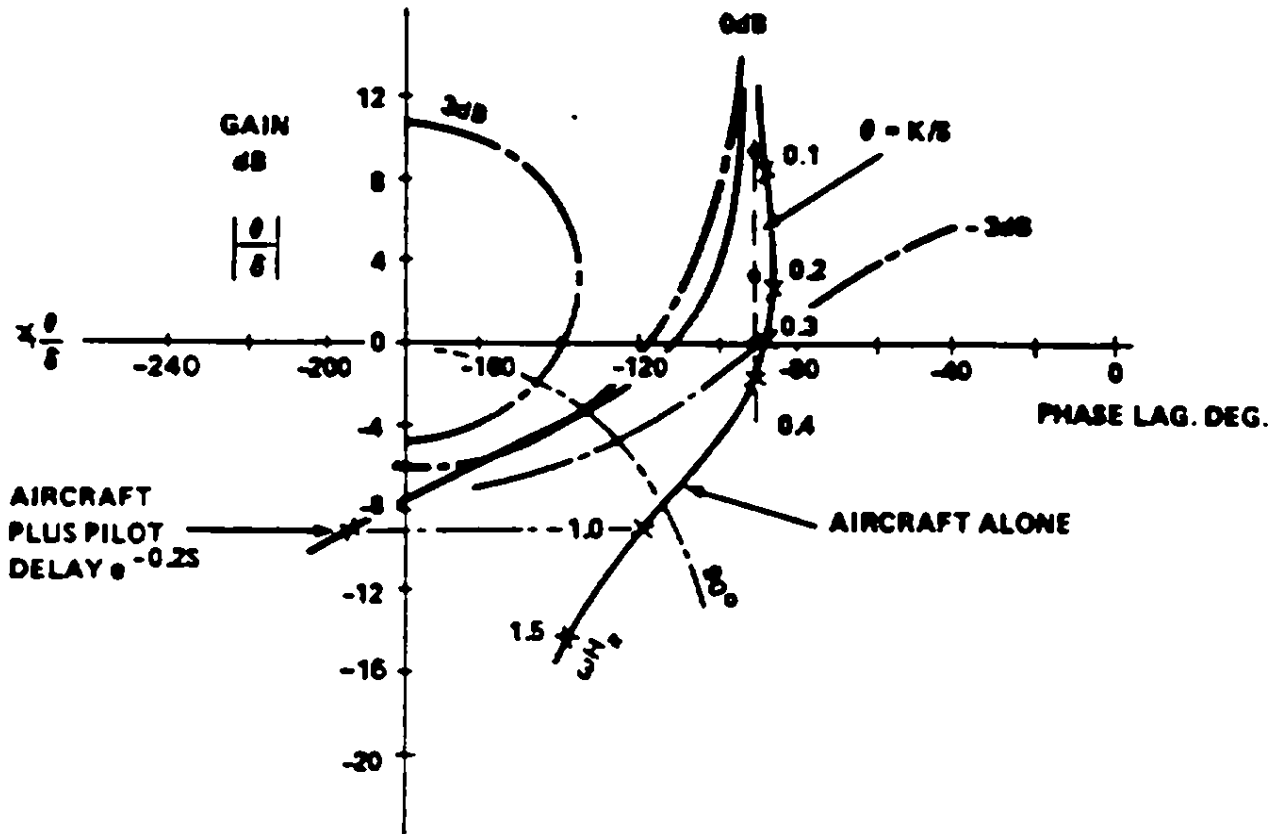

FIGURE 82. Low-order pilot - aircraft attitude frequency response.

- The pitch rate overshoot ratio seems to qualify the drop back behavior, with a value greater than 3.0 resulting in unacceptable drop back as small as 0.25 seconds. The trends are indicated on figure 80.
- Small values of flight path time delay were associated with excellent flight refueling control, but were not essential for good gross maneuvering and did not on their own ensure predictable behavior.
- Overshoots in normal acceleration did not cause unpredictable behavior unless associated with low frequency, breaching the upper right-hand time response boundary of figure 74.

These factors point to a number of design criteria and trend indicators which have been put to use in control law developments with excellent results. No attempt has been made to define the equivalent of Level 1, 2 or 3 limits and the most appropriate location seems to be here in the handbook, as guidance.

One result stands out clearly as a candidate for a new requirement. This is to specify that attitude drop back be zero or positive, as negative values were always rated sluggish and unsatisfactory in these experiments. This leads also to the result that some pitch rate overshoot is always necessary for optimum handling, with the function of minimizing drop back for tracking inputs or of rapid generation of the angle of attack increment required for crisp flight path response in gross maneuvers, landing flare, etc. It has no significance otherwise for the pilot unless it becomes too large. However, it has been shown in other results that a small attitude overshoot can be satisfactory for basic attitude control, e.g. in aerobatics, cruise, etc., and for attitude tracking with rigid or small travel sticks.

The principal time response features can be identified in the $\omega_{sp} T_{0_2} - \zeta_{sp}$ format discussed earlier, as 4D shown on figure 81. Some are constant for all T_{0_2} and the others vary in proportion to T_{0_2} .

MIL-STD-1797A
APPENDIX A

Constant features:

- Zero attitude dropback line, along which the flight path time delay t_γ equals T_{θ_2} .
- Pitch rate overshoot ratios.
- PIO line where $2\zeta_{sp} \omega_{sp} = 1/T_{\theta_2}$, an artifact of variable stability experiments not achievable by aerodynamic means. Serious PIO and extreme pilot nonlinearity occur below this boundary.

Variable features:

- Times to the first pitch rate peak, t_q .
- Non-zero attitude dropback, along which $t_\gamma = (T_{\theta_2} - \text{dropback})$. Note $t_\gamma = 2\zeta_{sp}/\omega_{sp}$ also, figure 78.

Analysis of low-order aircraft indicate that the satisfactory range of Category A short period frequency is limited by values of t_q between about 0.3 and 0.9 seconds. The area of satisfactory handling therefore lies in the upper pan of the figure for large T_{θ_2} and moves down to the lower part with reducing T_{θ_2} . Larger values of t_q are satisfactory for Category C, e.g., from 0.5 to 1.1 seconds for Class 4 aircraft up to possibly 2.0 seconds for large aircraft. With typical T_{θ_2} of 1.5 to 2.0 at low speed this is in a region of large dropback and pitch rate overshoot, but these are acceptable up to at least 1.5 and 3.0 respectively.

The PIO line forms a lower limit which should not normally be approached if conventional damping augmentation practices are followed, a practical limit slightly above it being expected. The zero dropback line should normally be respected but in some cases the limit may be above it, e.g. in the landing approach with $T_{\theta_2} = 2.0$ the satisfactory Class 4 t_γ limit of 1.5 seconds sets a minimum of 0.5 dropback. With smaller T_{θ_2} a lower frequency can make a nominal zero dropback look like a large overshoot in the first few seconds of the landing flare, but this is avoided by observing the t_q limit.

These time response carpets cannot be used for plotting high-order aircraft results, as they will contain a mixture of aerodynamic and FCS modes. Although the dropback and path delay remain connected by T_{θ_2} , they and the pitch rate overshoot and time to peak no longer have a unique relationship to $\omega_{sp}T_{\theta_2}$ and ζ_{sp} . For the analysis or design of such systems the time-response features are considered individually. Additional high-order effects will be evident most importantly in t_q , the delay in reaching the pitch acceleration peak which is a strong indicator of PIO and handling problems when greater than 0.3 seconds. The elimination of this defect is achieved by the frequency response shaping discussed later.

A conclusion to be drawn is that for low-order aircraft with elementary pitch damper augmentation, a low maneuver margin should be aimed for, with its inherently high natural damping, if precision pitch handling is required. This is completely consistent with the excellent Lightning low-altitude, high-speed (LAHS) pitch handling characteristics where in fact a frequency lower than the MIL-F-8785C minimum is satisfactory, together with only 2.0 lb/g stick forces. The much larger TSR2 prototype also had a low maneuver margin, with good damping in the LAHS region and was taken on only its 20th flight to 550 knots at 250 feet over hilly terrain without any stability augmentation. It was rated as having control and response well matched to this task.

From the combination of the facts that the MIL-F-8785C frequency is proportional to speed and the flight is path time delay is inversely proportional to frequency (given constant maneuver margin and damping), and hence that this time delay is inversely proportional to speed, it will be observed that the path distance

MIL-STD-1797A
APPENDIX A

represented by the delay is constant. In effect this reveals that the flight path response bandwidth could be considered to be constant and independent of speed, which may be of relevance to close-in air-to-air combat. If this is the case then this result is compatible with the concept of a fixed attitude frequency-response bandwidth independent of speed also, a subject discussed here and also in AFWAL-TR-82-3081.

We note that pitch-attitude overshoot (negative drop back, figure 73) and normal-acceleration hang-off tendencies are sometimes found in rate command/attitude hold systems. One solution then is to quicken the sluggish response by addition of a feed forward directly to the control surface.

Much work was done in attempting to predict pilot opinion from closed-loop analyses, though this does not seem to have been followed in more recent years with the exception of the Neal and Smith criterion. With the advent of the computing power potential of digital fly-by-wire it is now much more useful to the flight control system designer to attempt to shape the aircraft frequency response into a form known to be attractive to the pilot, with which he can perform both well and easily and hence will result in a good opinion rating. The pilot model which achieves this aim is well known to be the simple gain and time delay, the latter always being present in random error tracking. It is possible to define an envelope of aircraft attitude response which is very robust, in the sense that the pilot can achieve good closed-loop control with a wide range of gain and delay only. In this approach it is unnecessary to define a pilot-vehicle bandwidth since he has a wide choice according to the needs of the task.

The classical aircraft dynamics which have always been shown to achieve the best ratings in simple tracking experiments are a pure-gain pitch rate response and the resulting attitude response of K/s. Real aircraft have inertia, control power limits, and pilots who dislike excessive pitch acceleration, and can only be represented by this model at low frequencies. These attitude responses are indicated on figure 82 using the Nichols' chart form on which open-loop and closed-loop responses are related. Because of this facility these charts are often more useful to the FCS control law designer than the more usual Bode plots, even where no pilot model is being added to the aircraft response. On figure 82 a pilot gain and delay model is added to a pure low-order attitude response to show good closed-loop performance with negligible droop or resonance. The gain is chosen to give the pilot-vehicle open-loop crossover frequency of 0.3 Hz, and a small delay typical of simulation results is selected. A K/s response is included for comparison with the aircraft response with the crossover frequency.

This basic pilot model assumption underlies the aircraft response boundary limits used as a design criterion. The crossover frequency typifies the upper end of the 1 to 2 rad/sec. range and the 0.2 second time delay typifies the pilot delay noted generally in the literature in simulation experiments. WADC-TR-57-520 measured the difference between flight and simulation to show that, while the lead or lag equalization did not change, the pilot gain was lower and the time delay was larger in flight.

Choice of these values therefore represents an upper limit on pilot performance in the definition of aircraft response boundaries. The choice of frequency in Hz rather than radian/second is deliberate since the pilot sees frequency behavior in terms of its period or cycles per second, and this serves to present a more obvious view of the effect of such boundaries.

Figure 75 shows optimum aircraft pitch attitude response boundaries for precision tracking tasks, in which the crossover frequency of 0.3 Hz is inherently achieved with a low pilot gain appropriate to an aircraft low stick force per g. If this criterion is satisfied, the allowable pilot phase lag for optimum tracking can be attributed to his time delay and no further equalization is required from him. If the pilot chooses a lower crossover frequency, the allowable lag increases and he can adopt a larger time delay without departing from a good closed-loop performance.

These boundaries do not represent overall Level 1 limits. Depending on the task, responses outside them can be very satisfactory. General characteristics associated with areas outside the boundaries are indicated,

MIL-STD-1797A
APPENDIX A

and were derived from correlation with comment data from AFFDL-TR-74-9 and up-and-away flight configurations. While the boundaries represent the small number of cases which were optimum for all tasks, some cases attained Level 1 ratings for flight refueling despite bobble severe enough to degrade pitch tracking to Level 2, and the best flight refueling case (really excellent) was close to the boundary confines but was a poor Level 2 for gross maneuver because of unpredictable g response. Despite this it had excellent flight path control with small delay, provided that aggressive control was not attempted. More generally, attenuation greater than 5 or 6 dB/octave near the crossover frequencies is associated with sluggish, unpredictable flight path control.

PHASE LAG

For an ideal low-order aircraft the maximum possible phase lag is zero for pitch acceleration, 90 degrees for pitch rate, 180 degrees for pitch attitude, 270 degrees for flight-path angle, etc. Long experience has shown that the addition of moderate actuation phase lags need not alter the essential low-order characteristics so far as the pilot can observe them. It is also well established that good handling qualities are confined to regions within this broad definition of low-order systems.

Hence an overriding consideration for high-order flight control system design should be an attempt to contain phase lags to values no greater than the above plus say an extra 30 degrees for all frequencies below 1.5 Hz or preferably even 2.0 Hz.

OTHER CONSIDERATIONS

Gibson's views on pilot-induced oscillations are discussed under 4.2.2 Guidance.

For Level 3, see the discussion in section A and the supporting data in section B of 4.2.1.2 Guidance

REQUIREMENT LESSONS LEARNED

Three major lessons have emerged from recent work on equivalent systems, and from flight experience with several prototype airplanes.

- a. There are sufficient parameters in the equivalent system models to allow correlation with flying qualities problems of the very high-order systems which have so far been designed for operational aircraft
- b. Of these equivalent parameters, large equivalent delays are highly correlated with pilot-induced oscillation tendencies.
- c. Succumbing to the temptation to add complexity to the flight control system can easily degrade, rather than improve, the handling qualities.

The second lesson, though evident in the in-flight simulation data of DiFranco, Neal and Smith, and LAHOS (AFFDL-TR-68-90, AFFDL-TR-70-74, and AFFDL-TR-78-122 respectively) has also been learned the hard way. The Tornado experience described by Gibson in AGARD-CP-333 was discussed in AGARD-AR-134 as follows:

[The Tornado description] is a rare example of a type of paper that should be encouraged. In this paper the airplane designer admits that his airplane, equipped though it is with a full authority fly-by-wire flight control system, turned out to have serious flying qualities problems that required solutions. The example is rare not because problems occurred, but because the designer was willing to report on the experience. In fact, similar problems (pitch PIO in landing caused by control system phase shift and roll PIO caused by high roll control gain) have been experienced in highly augmented aircraft designed in the USA such as the YF-17, YF-16, F-18, and Space Shuttle.

MIL-STD-1797A
APPENDIX A

In the Tornado example, the problem was related to excessive pitch command pins and the phase lag from low-frequency filters (i.e., large $-\tau_e$). Richards and Pilcher ("SETP Cockpit") give a frank discussion of PIOs (lateral in this case) encountered when the demanding task of shipboard landing was first evaluated with an early F-18 version containing excessive equivalent delay.

An important lesson learned from both the Tornado and F-18 experience is that the pilot-induced oscillations due to equivalent delay, or phase shift, though pronounced, can be very isolated. Lateral PIOs occurred in two of the 49 carrier landings performed with the F-18. Considerable flight experience had been accumulated on the Tornado before the hard landing reported by Gibson.

Differences between ground-based simulation and in-flight characteristics appear inherent in experience with the above aircraft. Presumably all these aircraft were simulated on ground equipment during the design, and their problems only appeared later in flight. The differences, seen in the early results of DiFranco (AFFDL-TR-68-90) and Parrag (AFFDL-TR-67-19) have also been the subject of some recent study. Figure 83 illustrates some differences between pilot ratings for various equivalent delays in various simulations. The figure is from AIAA Paper 80-1611-CP, which summarizes the lessons learned:

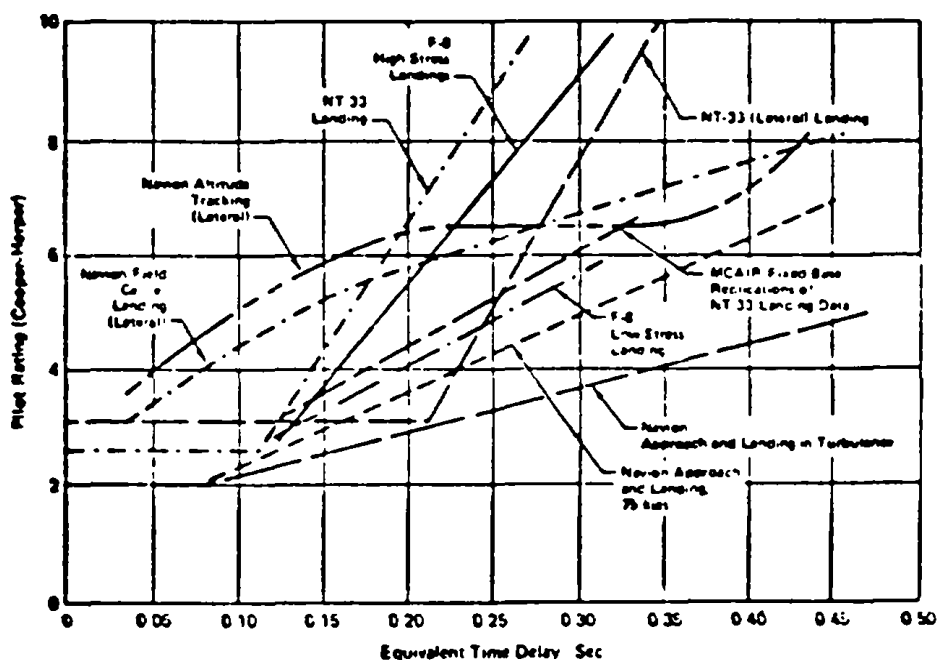

FIGURE 83. Comparison of equivalent delay effects in pitch or roll response to stick force for different simulations (from AIAA Paper 80-1611-CP).

Pilot rating degradation due to equivalent delays is often far more serious in flight than on a ground-based simulator.... Most of the data show a threshold in pilot rating degradation due to delay followed by a fairly linear increase in the rating.

The Navion in-flight results ["Pilot Opinions for Sampling Effects in Lateral-Directional Control" and AIAA Paper 79-1962] form both extremes of the data, i.e., producing the most immediate degradation due to delay (for lateral dynamics) and also the least ultimate degradation (for longitudinal dynamics).

The MCAIR ground-based data are similar to the F-8 low stress landings of Berry, et al [AIAA Paper 80-1626-CP]. The F-8 high stress landing data closely approach the NT-33

MIL-STD-1797A
APPENDIX A

longitudinal landing data [AFFDL-TR-78-122 and AFWAL-TR-81-3116] and the NT-33 lateral landing data [AIAA Paper 79-1783 and AFWAL-TR-81-3116]. A general trend of rating versus delay can be inferred.... However, there is much to be learned about lags and equivalent delay effects.

In the Supporting Data section an example of the value of equivalent systems was shown for an augmented aircraft. A more recent application of LOES provides even stronger support. An emergency backup control system, for the USAF AFTI/F-16 power approach and landing, was designed with a pitch rate feedback to the horizontal tail. Figure 84 illustrates the control system, and shows the θ/δ_e transfer function for the unaugmented AFTI/F-16 in the power approach (129 kt, 13.2 deg α). The feedback is intended to stabilize the short period, which consists of two first-order modes for the basic airplane. As figure 85 shows, the augmented airplane has two well-damped second-order modes, and the short-period mode (resulting from the coupled pitch rate lag and $1/T_{sp}^2$) is well within Level 1 limits for damping ratio and frequency.

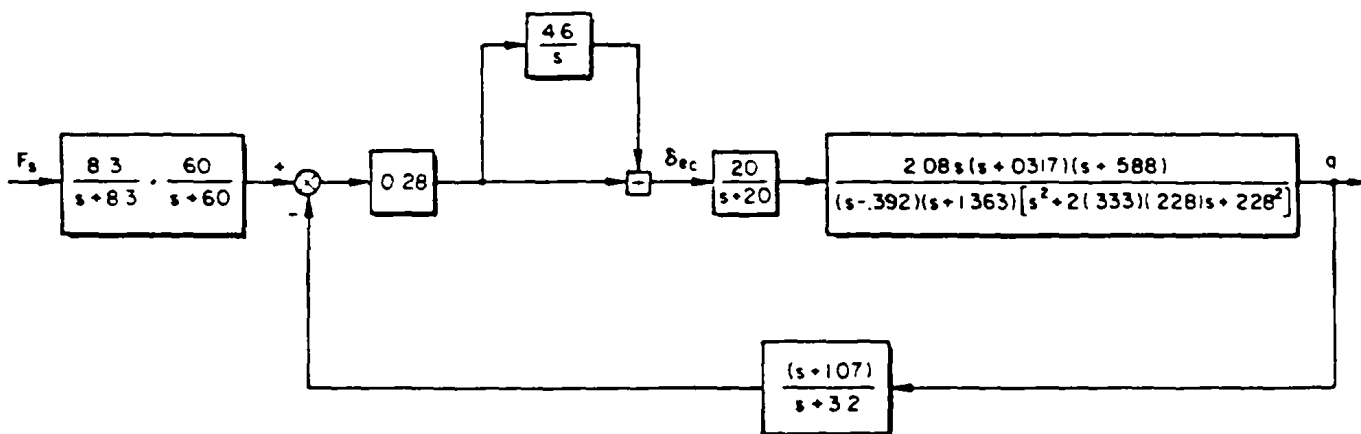

FIGURE 84. AFTI/F-16 independent back-up pitch rate feedback block diagram.

MIL-STD-1797A
APPENDIX A

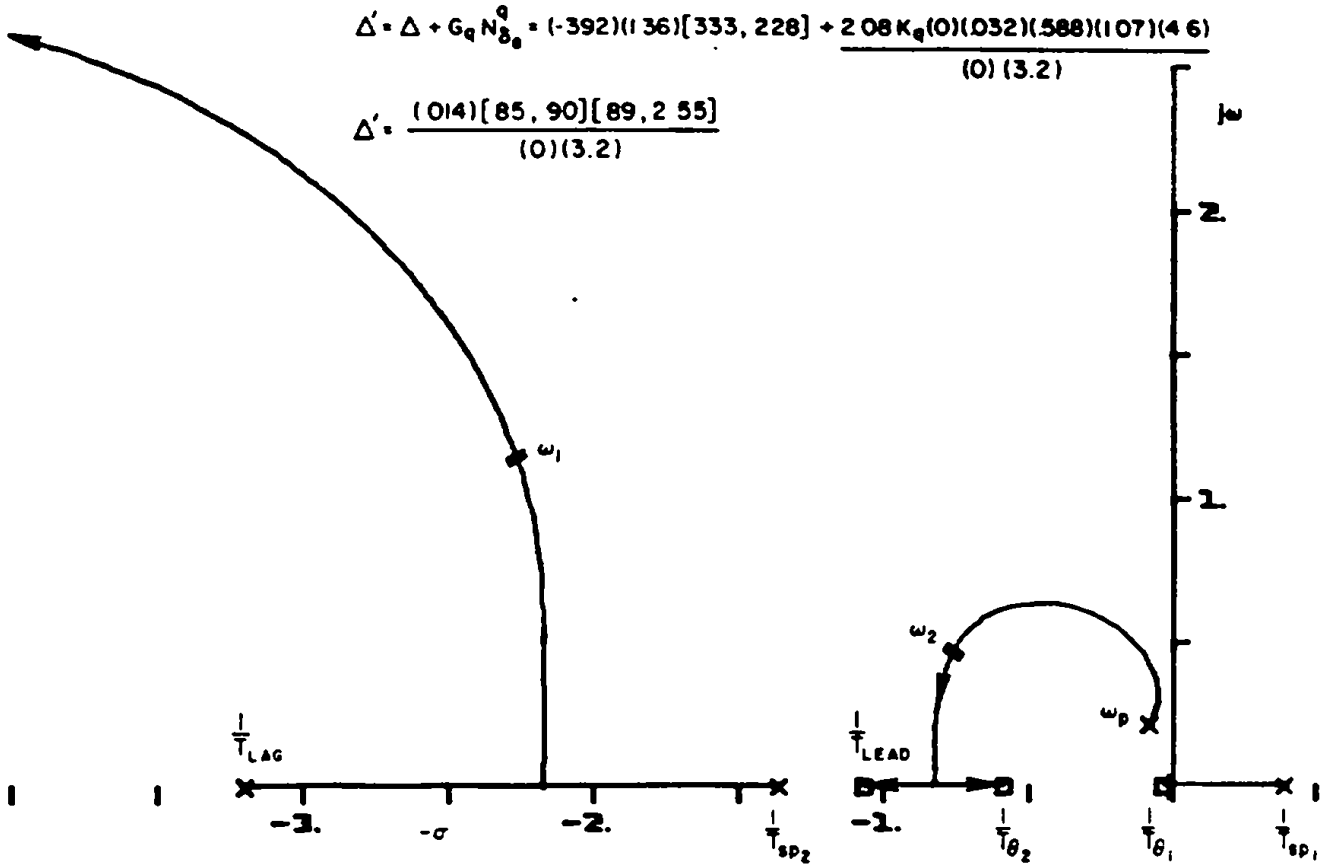

FIGURE 85. AFTI/F-16 $q \rightarrow \delta_e$ feedback (IBU).

However, when this system was simulated and flown on the USAF/Calspan NT-33, it received Cooper-Harper pilot ratings of 8 and 9, and was considered extremely sluggish with very heavy control forces. An equivalent system match of the θ/F_s transfer function (see figure 86) clearly shows why the airplane was Level 3: equivalent $\omega_{sp} = 0.685$ rad/sec (with $n/\alpha = 3.9$) is Level 2 on figure 13c; and $\tau_e = 0.186$ is Level 2. What appeared to be an adequate augmentation (figure 86) results in an airplane that is not much better than the basic F-16. Note that the equivalent short period is lower than either ω_1 or ω_2 in figure 86 - an illustration of the fact that it is incorrect to pick a dominant root to plot on the figure 13 boundaries.

MIL-STD-1797A
APPENDIX A

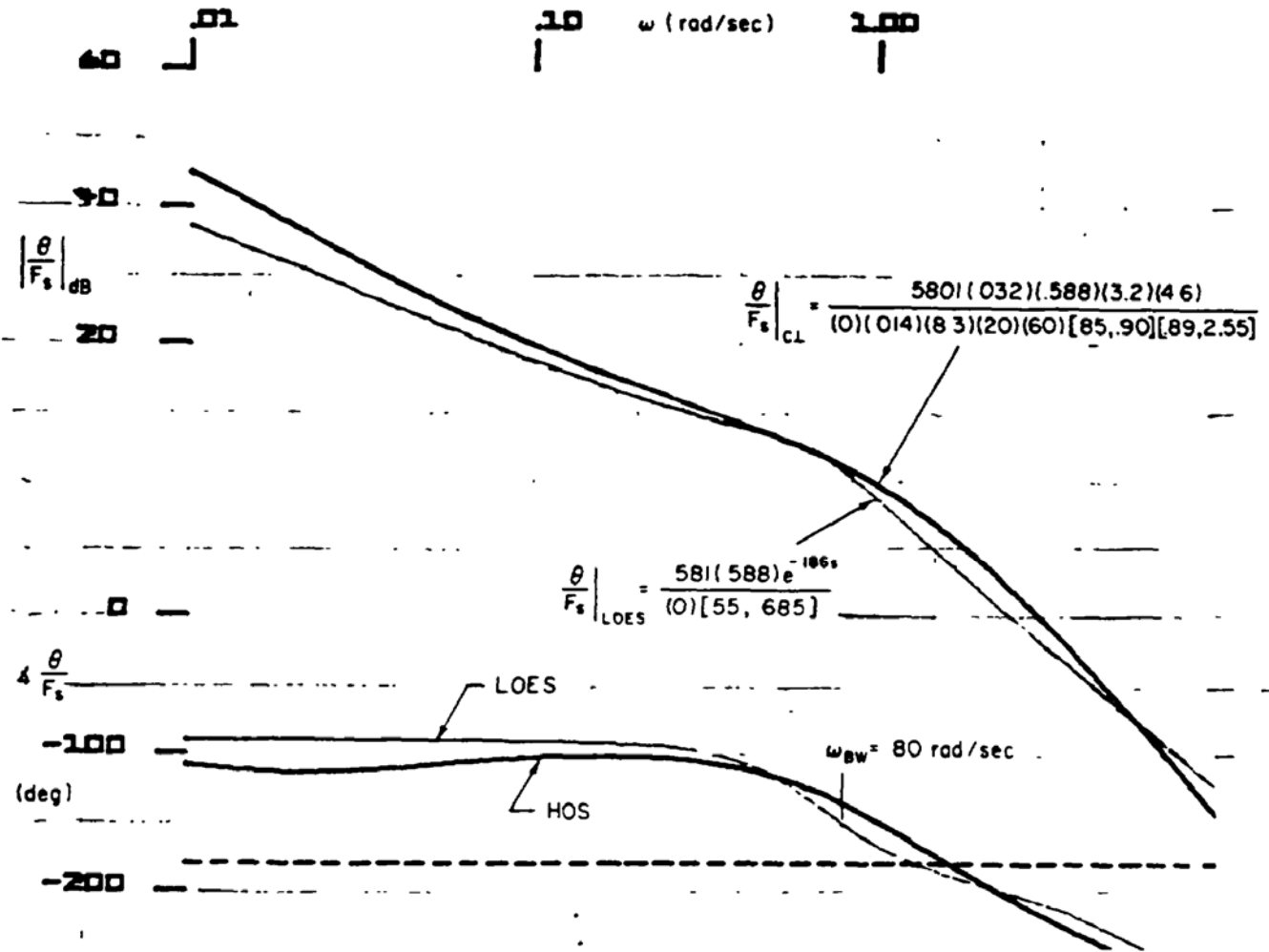

FIGURE 86. AFTI/F-16 $\theta \rightarrow F_s$ for IBU ($q \rightarrow \delta_e$ closed).

In its application to direct force control modes, AFWAL-TR-81-3027, the bandwidth criterion was found to work in areas where conventional criteria are inappropriate. This is discussed in more detail in 4.6.1.3.

Another lesson is that many pilots dislike having to push forward to get the aircraft on the ground at the end of a landing flare, a characteristic noticed on a number of attitude-hold systems. They can learn to do it, but it is against training and instinct.

Rynaski (Calspan Final Rpt No 7205-8) and Hoh ("STOL Handling Qualities Criteria for Precision Landing") point out that the location of the integrator inverse time constant with respect to $1/T_{\theta_2}$ [figure 87], and the low-frequency residue, can alter the classical α response, in which a step control input soon produces a constant angle-of-attack increment. The q feedback will tend to cancel some poles with zeros of the q/q_e transfer function to give a normal-looking mid-frequency response, and also to suppress the low-frequency phugoid response; but the zeros of α/q_e and γ/q_e do not cancel any closed-loop poles. As a result, a conventional-appearing θ/q_{cmd} response can easily be obtained but the α/q_{cmd} and γ/q_{cmd} transfer functions must still have an extra pole-zero pair. Only if $1/T_q$ is chosen to be near $1/T_{\theta_2}$ can the α

MIL-STD-1797A
APPENDIX A

response to a step command be kept from ramping off instead of reaching a steady value, as it does in the conventional case. Unless $1/T_q$ is so chosen, there will no longer be a consistent relationship between γ and θ (since θ is still $\alpha + \gamma$), so that the common piloting technique of controlling γ through θ will be more difficult. This inconsistency could be important in tasks involving precise control of the flight path.

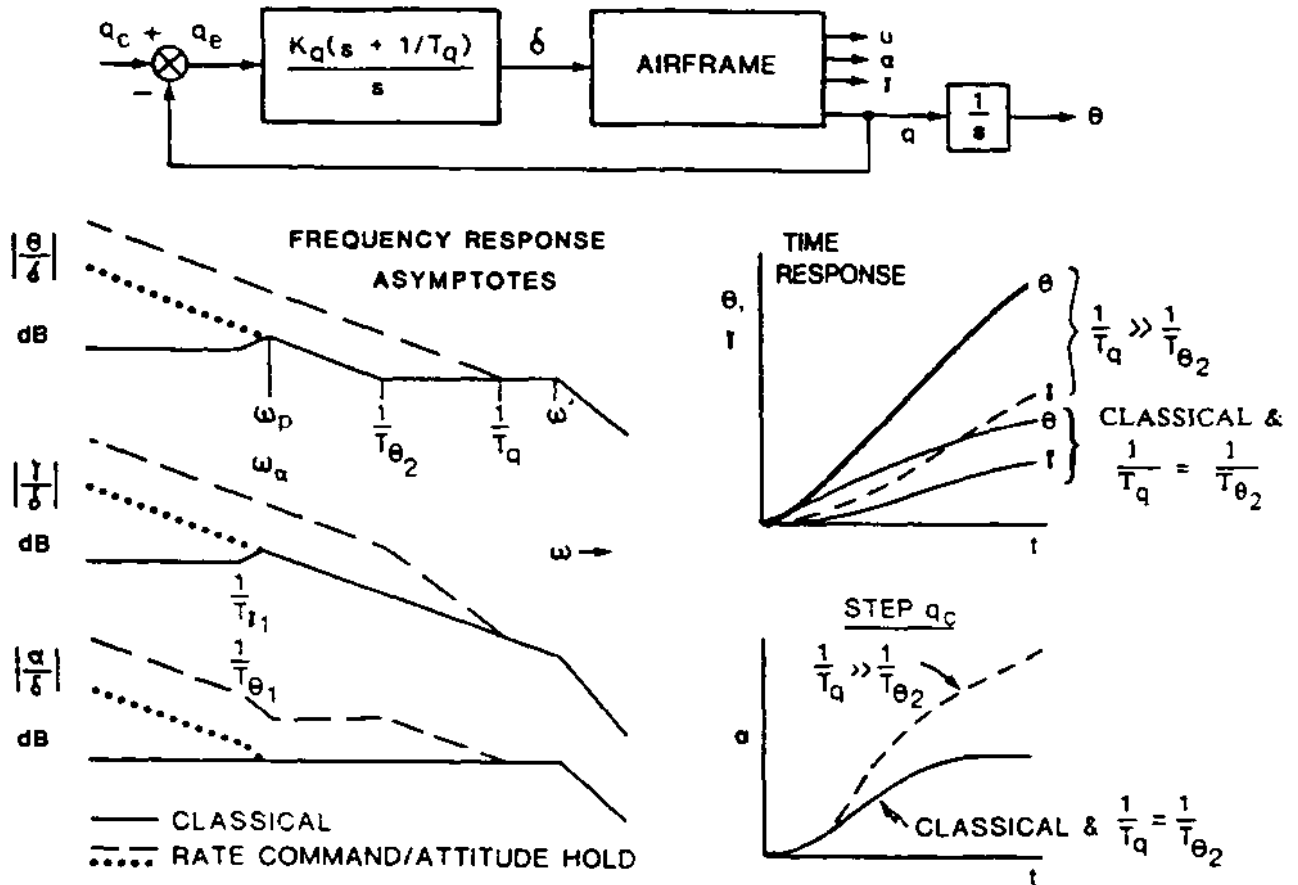

FIGURE 87. Frequency and time response comparison.

5.2.1.2 Short-term pitch response-verification.

Verification shall be by analysis, simulation and flight test.

VERIFICATION RATIONALE (5.2.1.2)

As the design progresses, analysis, simulation and flight test will be appropriate demonstration means. In the end, flight tests will measure some parameters directly and collect data to validate analytical and simulator results for the rest.

For Level 3, the time to double amplitude must be obtained using the perturbation values of pitch attitude (or airspeed) away from trim. (A step input establishes a new equilibrium airspeed, but an impulse or doublet does not. Thus for some seconds after a step control input the difference between stability and instability may not be discernible.)

MIL-STD-1797A
APPENDIX A

VERIFICATION GUIDANCE

The related MIL-F-8785C requirements are paragraphs 3.2.2.1, 3.2.2.1.1 and 3.2.2.1.2.1.

a. Analysis

As a guide to critical flight conditions, here are some simple analytical approximations for some longitudinal dynamics parameters. Values of the corresponding equivalent-system parameters, however, may be quite different because of higher-order effects [This possibility applies to transfer-function zeros (e.g., $1/T_{\theta_2}$) as well as poles] even if there is only one pitch controller.

Static margin: $h_n \doteq C_{m_\alpha} / C_{N_\alpha}, \% \bar{c} / 100$ if $M_u \doteq 0$
(More generally, h_n is related to $d\delta_e/dV$ in stabilized straight flight)

Maneuver margin: $h_m \doteq -[C_{m_\alpha} / C_{N_\alpha} + C_{m_q}, g\rho \bar{c} / (4W/S)], \% \bar{c} / 100$

Phugoid: $\omega_p^2 \doteq 2(g/V)^2 h_n/h_m + \text{thrust \& Mach effects}, r^2/s^2$
 $2\zeta_p\omega_p \doteq 2(g/V)(C_D/C_L) + \text{thrust \& Mach effects}, r/s$

Short period: $\omega_{sp}^2 \doteq gh_m / (C_{L_1} k_y^2 \bar{c}), r^2/s^2$
 $2\zeta_{sp}\omega_{sp} \doteq [C_{N_\alpha} - (C_{m_q} + C_{m_\alpha}) / (2k_y)^2] \frac{g}{VC_{L_1}}, r/s$
 $n/\alpha \doteq C_{N_\alpha} / C_{L_1}$
 $1/T_{\theta_2} \doteq (g/V) (n/\alpha)$
rise time $\Delta t \doteq 1 / (T_{\theta_2} \omega_{sp}^2)$

where

$$C_{L_1} = W / (\bar{q} S), \quad k_y^2 = I_y / (m \bar{c}^2)$$

Frequency-response magnitude and phase

Factor	Exact	Approximate	
$(j\omega + 1/\tau) \pm 1 = Me^{j\Phi}$	$M = (\omega^2 + 1/\tau^2)^{1/2}$ $\Phi = \pm \tan^{-1}(\tau\omega)$	$M \doteq (1/\tau) \pm 1$ $\Phi \doteq \pm \tau\omega$	} for $\omega \ll 1/\tau$
$[(j\omega)^2 + 2\zeta\omega_n j\omega + \omega_n^2] \pm = Me^{j\Phi}$	$M = [(\omega_n^2 - \omega^2)^2 + 4\zeta^2 \omega_n^2 \omega^2]^{1/2}$ $\Phi = \pm \tan^{-1}\{2\zeta(\omega/\omega_n) / [1 - (\omega/\omega_n)^2]\}$	$M \doteq \omega_n \pm 2$ $\Phi \doteq \pm 2\zeta(\omega/\omega_n)$	} for $\omega \ll \omega_n$

MIL-STD-1797A
APPENDIX A

$$\left. \begin{aligned} M &\doteq \omega \pm^2 \\ \Phi &\doteq \pm \pi \mp 2\zeta\omega_n/\omega \end{aligned} \right\} \text{for } \omega \gg \omega_n$$

MIL-STD-1797A
APPENDIX A

The peak overshoot ratio for pitch response to a step control input can be estimated from figure 88. It is apparent that overshoot are also possible with $\zeta_{sp} > 1$ or $\omega_{sp} T_{\theta_2} < 1$. A pure time delay, τ , Laplace transformed as $e^{-\tau s}$, gives a frequency-domain phase lag of $\phi = -\tau\omega$ and a constant magnitude of 1 (0 db).

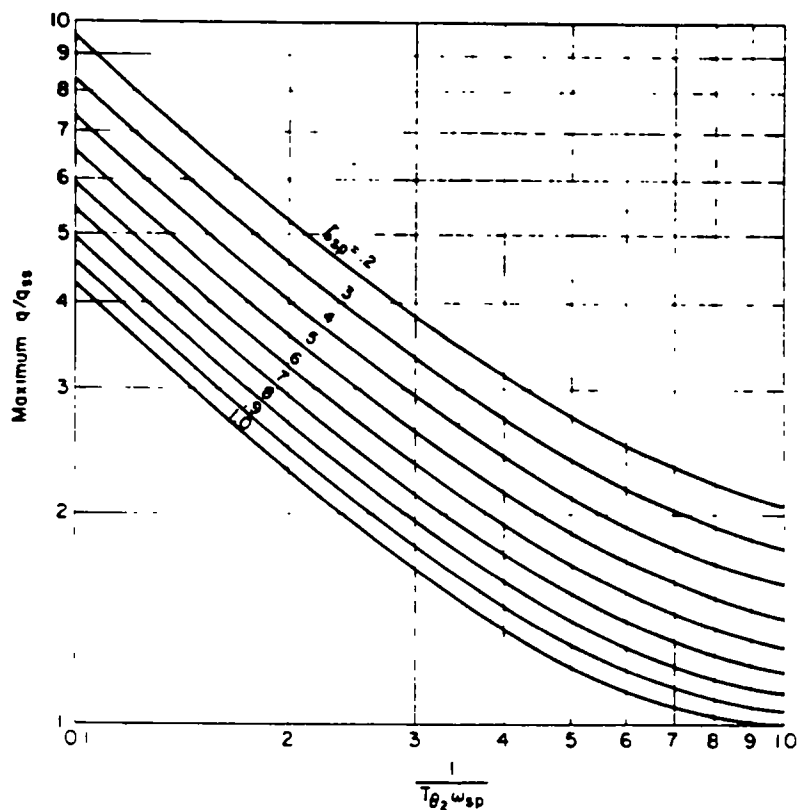

FIGURE 88. Maximum pitch rate overshoot for a step control input (from DOT/FAA/CT-82/130-II).

In determining the validity of equivalent-system parameter estimates, the kinds of feedback and compensation should be considered. In a simple case, matching only the pitch transfer function may be adequate for 4.2.1.2. But generally, for the most accurate parameter identification all the data available should be used. Pitch rate and normal acceleration only serve in more complex cases as a minimum to assure kinematic relationships that match the assumptions.

McRuer and Myers (DOT/FAA/CT-82/130-II) show that for a superaugmented aircraft using high-gain pitch-rate feedback with forward-loop integration (an equalization element $K_q(s + 1/T_q)/s$] gives a normal-looking short-period pitch transfer function except that its parameters are approximately

$$\omega_n^2 \doteq K_q M_\delta / T_q$$

$$M_\delta = \bar{q} S \bar{c} C_{m_\delta} / I_y$$

$$\zeta \doteq \overline{Q K_q T_q M_\delta} / 2$$

crossover frequency (where $M = 0$ dB) of high-gain asymptote:

$$\text{Numerator } 1/T \doteq 1/T_q$$

$$\omega_{c_0} \doteq k_q M_\delta$$

Such augmentation tends to eliminate the phugoid mode, giving a very flat pitch response at low-frequency (such an aircraft will be stable, although the u , α , γ and θ responses to control inputs will have

MIL-STD-1797A
APPENDIX A

a pole at $s = 0$). Care must be taken to account for all the contributions of flight control system components to the equivalent time delay.

While normally the trim n_z makes little difference in longitudinal dynamic response, there can be exceptions as aerodynamic characteristics vary with speed or Mach number and angle of attack. Roll-induced inertial coupling is the subject of 4.8.1. Especially at low speed or high angle of attack, sideslip or even coordinated turns can sometimes produce altered, coupled motions. The requirements apply throughout the flight envelope, and for all amplitudes of motion. Both flight- and computer-generated time histories, for example, can be Fast-Fourier-Transformed to get the equivalent linear-model parameters that best represent the full nonlinear, time-varying motion.

In order to meet the Neal-Smith pilot-in-the-loop criteria, the designer must succeed in finding a combination of K_p , T_{p1} , and T_{p2} which will cause the amplitude and phase of $Y_p Y_c$ to plot in the Level 1 region of figure 68. It is necessary therefore to perform a parameter search. This search procedure is not difficult; it can be performed graphically using aids described in AFFDL-TR-70-74, or the process can be mechanized on a digital computer. Because the calculations involved in evaluating the magnitude and phase of $Y_p Y_c$ as a function of frequency are simple to perform, it is feasible to use a simple trial-and-error approach to test whether or not a proposed aircraft design meets the criteria.

Construction of frequency responses for matching or plotting is conveniently performed by linearizing the high-order system (for all possible input amplitudes, if necessary). The linearized high-order model is almost always available because it is used in the design process. If it is not and, for example, a flight control element is to be changed on an existing system, and relinearization is not feasible, then fast Fourier analysis of a nonlinear simulation model of the system works well (as discussed below). The exact linearized model must account for the lower-frequency effects of structural filters, aliasing, etc. in order to faithfully represent the response in the frequency range of primary interest to flying qualities, past 10 rad/sec.

b. Simulation

Fast Fourier analysis of real-time or non-real-time simulations of the aircraft is best performed using responses to a stick force input with wide frequency content. Background can be found, for example, in "Applied Time Series Analysis, Vol. I, Basic Techniques."

c. Flight Test

Flight testing goals are to identify the aircraft, evaluate its operational merits, and determine specification compliance. With limited flight time and test resources available, it is a challenge to get the data needed. Only a very limited amount of compliance will be demonstrated directly. For the rest, flight validation/correction of analytical models of the aircraft will make further checking possible.

AIAA Paper 80-1611-CP, AFFTC-TR-77-27, AIAA Paper 80-1633, and AFWAL-TR-81-3027 describe fast Fourier reduction of flight data. AFFTC-TR-77-27 describes AFFTC experience with the method. AIAA Paper 80-1633 discusses use of an electronically generated frequency sweep which worked adequately, and AIAA Paper 80-1611-CP shows that FFT can work adequately even when the test condition is theoretically least suited to the method. AFWAL-TR-81-3027 shows a pilot-generated frequency sweep that worked very well. A typical frequency sweep and the resulting Bode plot (for a direct side force control configuration from AFWAL-TR-81-3027) are shown on figure 89. The instrumentation required to obtain these data was minimal, consisting of a yaw rate gyro and a pedal position transducer.

d. Piloting Aspects of Flight Test for Augmented Aircraft

AIAA Paper 80-1611-CP discusses the piloting aspects of flight test for augmented aircraft, from which the following is extracted. The same factors apply to ground-based simulation.

MIL-STD-1797A
APPENDIX A

Figure [90] illustrates a landing time history of a configuration with 0.17 seconds actual delay in the longitudinal command path. The landing is reasonably routine. Figure [91] shows the same configuration, with the same pilot, on a different landing. A pilot-induced oscillation, with virtual loss of control, is evident. As discussed by Smith [AFWAL-TR-81-3116], a high rate of descent had developed which forced the pilot to control the aircraft more urgently.... The pilot awarded a rating of 5 presumably on the basis that the aircraft had been landed routinely, with some deficiencies, on two occasions, and control was almost lost on one landing due to one of those momentary aberrations which afflict pilots for reasons unknown.

During the simulation the pilot in question proved himself to be adaptable to widely different dynamics, whereas the main evaluation pilot in the same program, for example, registered a more consistently progressive deterioration in rating as the dynamic flying qualities parameters of the aircraft were degraded. The two pilots, though both highly skilled, therefore demonstrated a contrast in piloting technique. This contrast is significant because both adaptability and consistency are qualities which are needed, and therefore commonly exhibited, by many development test pilots. The adaptive technique, however, presents more of a challenge to the flying qualities engineer. He must pay particular attention to pilot briefing and to choice of piloting task.

Pilot Briefing - Augmented dynamics possess potential problems which might not appear unless the pilot adheres to the properly chosen demanding task. Therefore, the briefing should encourage the pilot to tackle the task aggressively but realistically. If the pilot is not aware of Smith's discussion of flying qualities cliffs, the briefing should include it [AFFDL- TR-78-122]. The classic cliff example is the peculiarity of lags in augmented dynamics, which can produce excellent flying qualities in loosely defined tasks, but pilot-induced oscillations in tightly-defined tasks. Therefore, the pilot should be encouraged to demand much of the aircraft.

Piloting Task - A demanding but realistic task must be flown to expose potential flying qualities problems. An offset precision touchdown has proved very suitable for exploring longitudinal landing dynamics, for example. However, this is not necessarily the critical task - for lateral dynamics. Task selection is difficult because pilot's perceptions of difficulty are sometimes misleading: the approach is commonly considered more difficult than flare and touchdown, for example, whereas the touchdown phase can clearly be critical [AFFDL- TR-78-122] There is an obvious need for operational realism in tasks, though there is some evidence that deliberately unrealistic tasks such as handling qualities during tracking (HQDT), might conveniently predict... difficulties in other more realistic tasks [AFFTC-TD-75-1].

The values of τ_p and ω_{BW} required to demonstrate compliance with the figure 57 boundaries are obtained from open-loop frequency responses of pitch attitude such as those shown in figures 15, 17, and 19. These plots may be obtained from analyses (figure 59) or from Fourier-transformed flight test or Simulator data such as was shown in figure 89. The Air Force Flight Test Center (AFFTC) has had considerable success in Fourier transforming flight test data taken during operational tasks (as opposed to specially tailored frequency sweeps). This saves flight test time and allows configuration identification at the flight condition to be utilized operationally.

If significant nonlinearities are present in the system, the open-loop frequency response will depend on the size of the input used in the identification process. When such nonlinearities are suspected, several frequency sweeps should be accomplished with different input magnitudes. Data taken during operational tasks will implicitly account for nonlinear effects if technically good data can be obtained.

MIL-STD-1797A
APPENDIX A

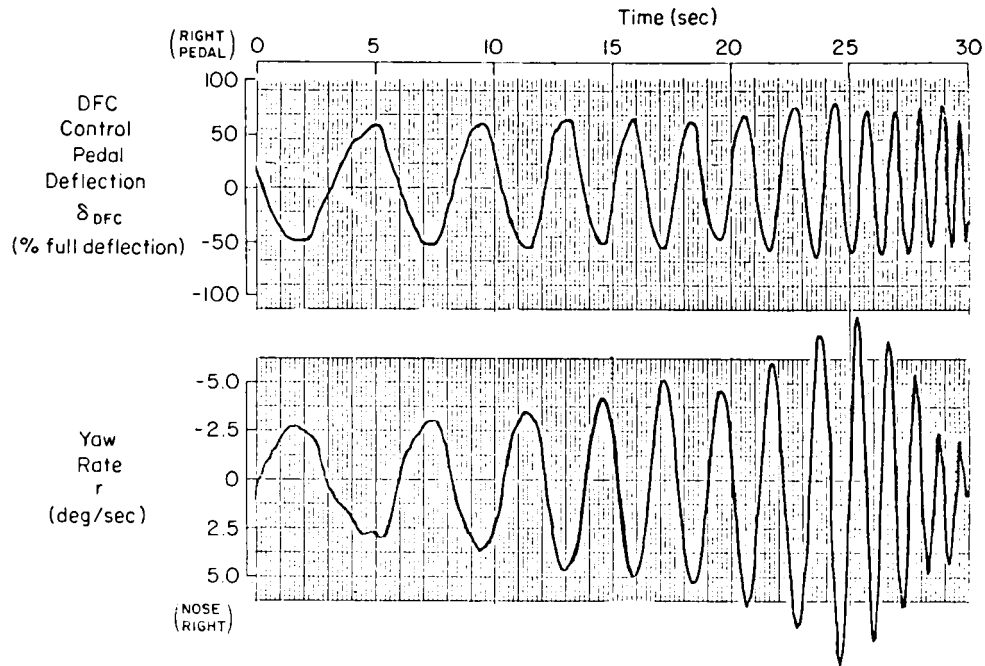

FIGURE 89a. Typical DFC control frequency sweep.

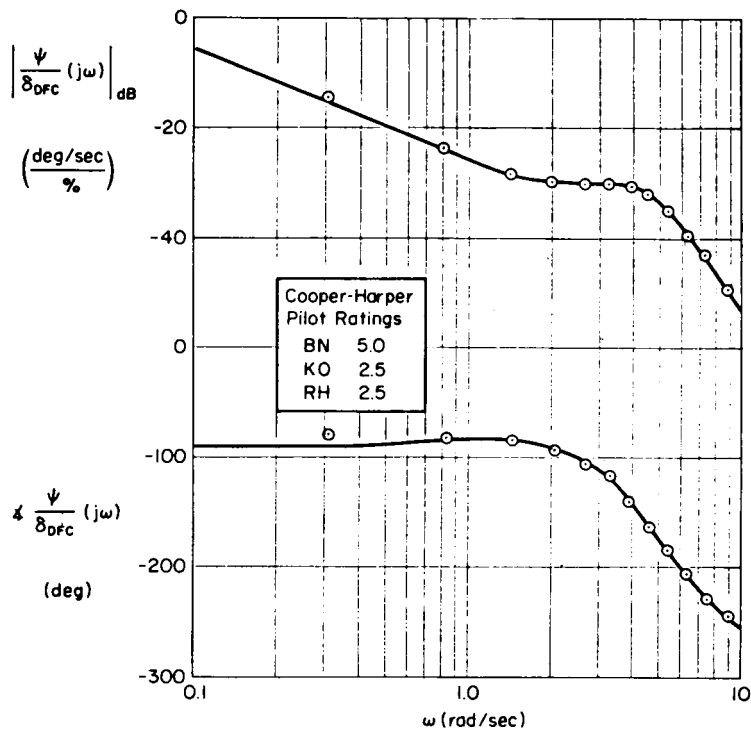

FIGURE 89b. Fourier transformed heading response.

MIL-STD-1797A
APPENDIX A

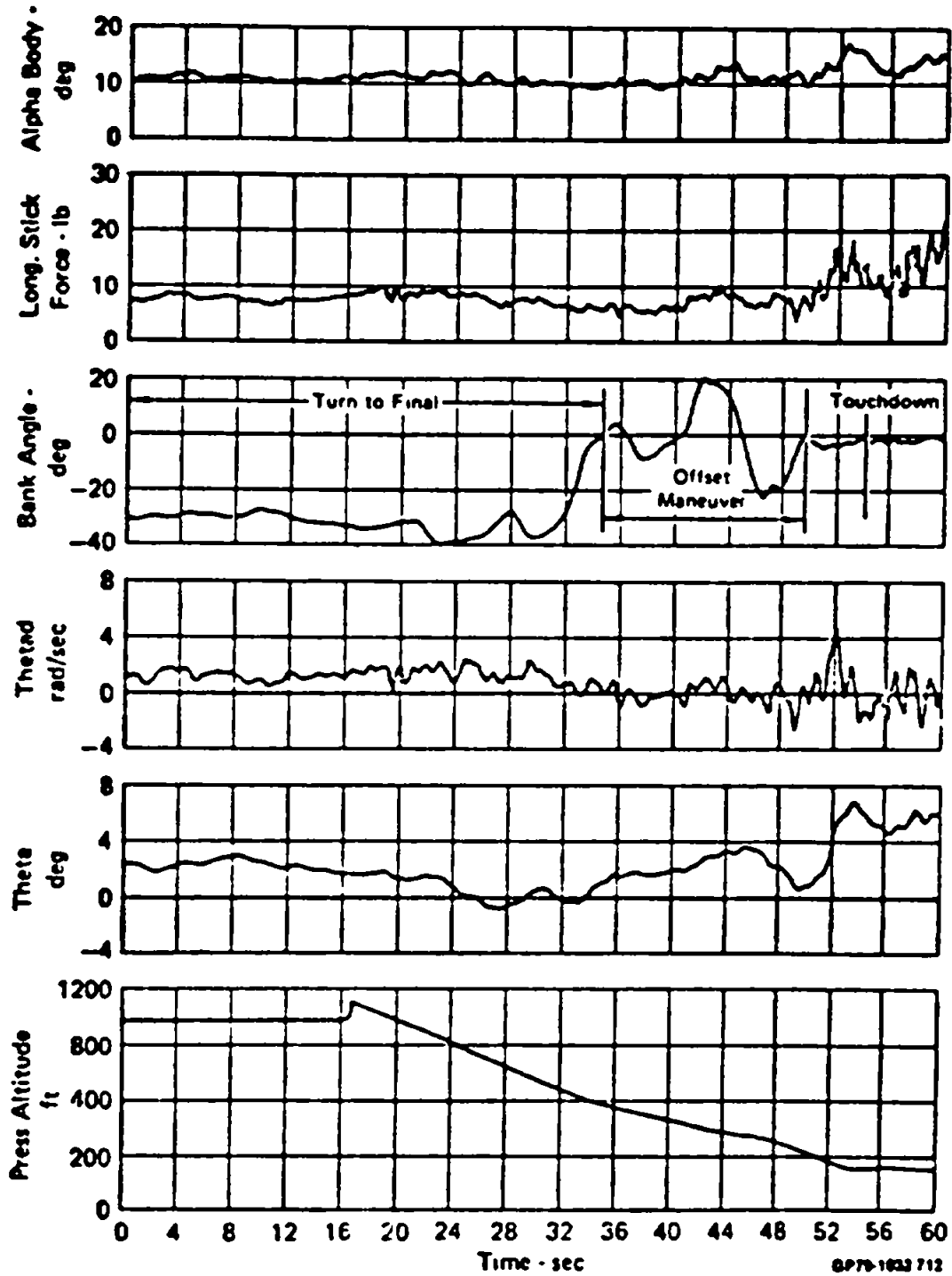

FIGURE 90. Approach and landing, no pilot-induced oscillation, configuration P12 of AFWAL-TR-81-3116, medium offset approach (75 ft lateral, 50 ft vertical), landing no. 1 (from AIAA Paper 80-1611-CP).

MIL-STD-1797A
APPENDIX A

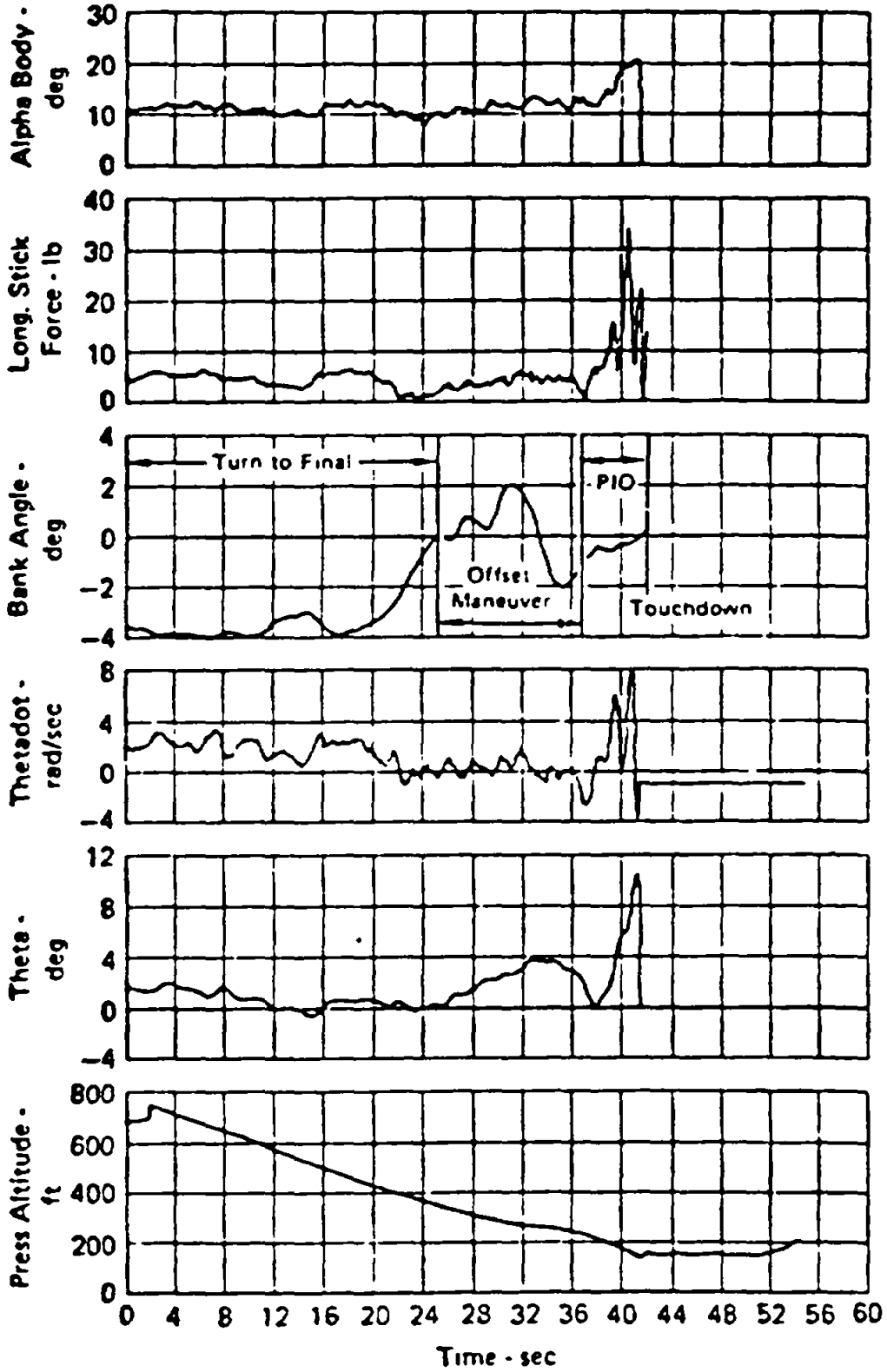

FIGURE 91. Pilot-induced oscillation at touchdown.

MIL-STD-1797A
APPENDIX A

VERIFICATION LESSONS LEARNED

Finding the instantaneous center of rotation for control inputs from time histories is usually not difficult, if normal acceleration is recorded at two or three longitudinal locations. However, in AFTI/F-111 analyses and simulations a combination of multiple flight control surfaces and aeroelasticity complicated the task. But the exact location is not critical; the goal is just to get the two n_z zeros well beyond the frequency range of piloted control.

Both theoretically and in practice, equivalent-system parameters determined by matching θ/δ_{es} or θ/F_{es} with fixed $1/T_{\theta_2}$ should be about the same as those determined by simultaneously matching θ and $n_{z_{CR}}$ with free $1/T_{\theta_2}$.

In practice a true step is not usually feasible. Time may be measured from the midpoint of the control input transient, as sketched, for the most abrupt input feasible. Good instrumentation will be needed to measure the time delay accurately.

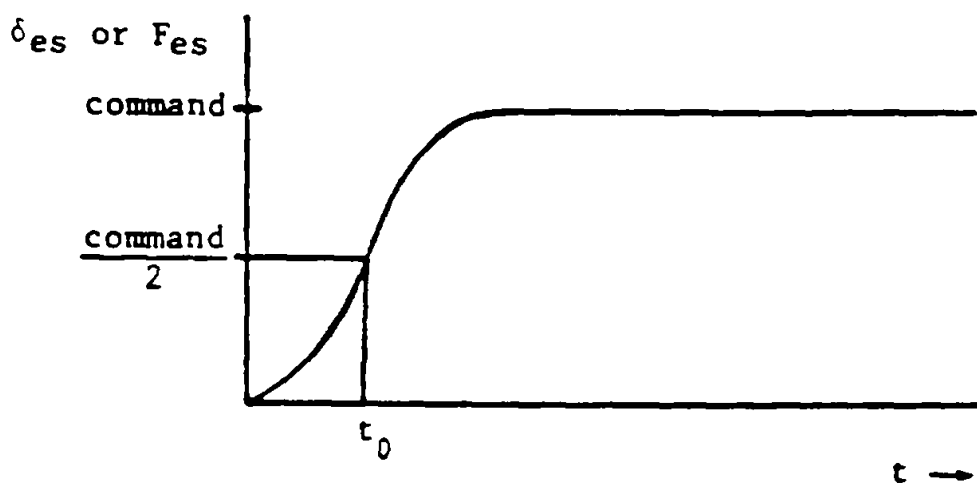

MIL-STD-1797A
APPENDIX A

4.2.2 Pilot-induced pitch oscillations.

The pitch attitude response dynamics of the airframe plus control system shall not change abruptly with the motion amplitudes of pitch, pitch rate or normal acceleration unless it can be shown that this will not result in a pilot-induced oscillation. The total phase angle by which normal acceleration measured at the pilot's location lags the pilot's pitch control force input at a criterion frequency, ω_R , shall be less than _____.

REQUIREMENT RATIONALE (4.2.2)

The purpose of this requirement is to insure that aggressive tracking behavior will not result in instabilities of the closed-loop pilot/aircraft system. Any such tendency will degrade or even destroy mission effectiveness and likely will be dangerous.

REQUIREMENT GUIDANCE

The related MIL-F-8785C requirement is paragraph 3.2.2.3.

Recommended value: When a quantitative requirement is desired, the specified phase angle should be less than $180 - 14.3 \omega_R$ degrees when ω_R is in radians/second. The criterion frequency ω_R is defined to be any frequency within the range $1 < \omega_R < 10$ rad/sec at which lightly damped (resonant) oscillations in pitch attitude can result from turbulence inputs or from piloted control of the aircraft when used in the intended operational manner. This requirement should be waived at the discretion of the procuring activity for those flight conditions for which the ratio of normal acceleration measured at the pilot's location to pitch rate, evaluated at the criterion frequency, is less than 0.012 g/deg/sec.

A related requirement is 4.2.8.2. Also, see 4.1.11.6 for a general PIO requirement. The qualitative requirement of MIL-F-8785C is generalized in view of uncertainties in the state-of-the-art of flight control system design, a tacit recognition of the complexity of the PIO problem; no detailed specification is, at this time, a guarantee against building a PIO-prone airframe/flight-control-system combination.

The requirement precludes PIO, PIO tendencies or general handling qualities deficiencies resulting from amplitude-dependent changes in aircraft dynamic response to pilot control inputs. These effects can be of mechanical origin, e.g. bobweights coupled with static friction, or due to saturation of elements within the control system, or due to compensation added to the automatic control system. PIO has occurred in the T-38A, A-4D, and YF-12 due to such abrupt changes. Other known sources are short-period dynamics (e.g. large $\omega_{sp} T_{\theta_2}$), feel system phasing (e.g. effective bobweight location not far enough forward), and sensitive control force and motion gradients. AFFDL-TR-69-72 and Norair Rpt NOR-64-143 can furnish some insight.

We are currently in somewhat of a quandary regarding a specific requirement for PIO. It would, in fact, seem that the equivalent systems and bandwidth requirements (4.2.1.2) as well as the transient F_s/n criterion (4.2.8.2) were specifically formulated to insure that piloted closed-loop tracking in the pitch axis would be satisfactory. Hence, this requirement to some extent seems redundant. The following discussion of the proposed criterion, originally presented in AFFDL-TR-77-57, is taken from AFWAL-TR-81-3109.

The PIO theory of AFFDL-TR-77-57 postulates that if the pitch (θ) loop is resonant at frequency ω_R , then the pilot may at some time (which cannot necessarily be predicted) attempt to control normal acceleration a_{zp} to the exclusion or near exclusion of θ . According to AFFDL-TR-77-57, a PIO may occur when the open-loop pilot - vehicle normal-acceleration response $n_z(j\omega)/n_{z_e}(j\omega)$ (the subscript e denotes the error sensed by the pilot) is subjectively predictable: concentrated about some resonant frequency within the pilot's bandwidth of control, with a magnitude there above a threshold value. This situation may arise during pitch target tracking or as a result of the pitching response to a large, abrupt control input, failure transient or gust. A pilot attempting to control normal acceleration at that frequency will incite a PIO if no

MIL-STD-1797A
APPENDIX A

phase margin exists there; that is, if the phase angle of the $n_z(j\omega)$ transfer function is as negative as -180 deg at the resonant frequency. Using a pure 0.25 sec time delay plus gain to model the pilot, the stated phase requirement for the aircraft is evolved. Violation of the phase criterion implies that if the pilot switches to a_{zp} control, the acceleration loop will be dynamically unstable and a PIO will be initiated. This paragraph provides the flight control system engineer with a quantitative criterion for minimum required dynamic performance of feel and control systems.

The minimum amplitude cited is proposed as a quantitative guide for preliminary identification in the design process (airframe or flight control system) of a threshold of pilot sensitivity, below which PIOs are unlikely. A combined threshold is postulated of maximum acceptable rms pitch rate in tracking and minimum a_z consciously felt by the pilot. More data should be collected from in-flight simulation to establish the validity of this response ratio; the number selected, 0.012 g/deg/sec, conforms to past cases of longitudinal PIO (AFFDL-TR-77-57).

The frequency ω_R is, in disguise, a closed-loop, pilot/vehicle parameter. Fortunately it is also a very physical parameter (pitch loop resonant frequency) that is readily understood and accepted. No method is given in the standard for its selection; methods for doing so are contained in AFFDL-TR-77-57. The frequency ω_R can be readily identified from flight test.

The existence of a significant resonance in closed-loop pitch attitude control indicates that the pilot has closed the loop with very little phase or gain margin. It is difficult to conceive how such closures would occur on aircraft that meet the Level 1 equivalent system or bandwidth boundaries (4.2.1.2).

Gibson's views of PIOs are taken directly from ICAS-86-5.3.4:

High order characteristics are associated with pilot-vehicle closed loop handling problems or PIO. As this term has been used to describe low order problems, the differences should be clearly understood. The abrupt pitch bobble type is discontinuous, consisting of repeated tracking corrections. The sluggish pitch overdriving type is also discontinuous with input pulses to stop the unpredictable excess in response. Although the aircraft is not under complete control, it is not out of control.

High-order PIO is a continuous out of control attitude instability, the amplitude ranging from small to large and potentially destructive. Because the problem is due to inadequate pilot-vehicle closed loop gain and phase margins, examination of the pitch attitude frequency response identifies the cause and the solution.

Figure 76 shows the features which separate low and high-order pitch handling. The area of interest can be confined to the region of phase lags between 180 and 200 degrees which determines the PIO frequency. This arises from the success of the synchronous pilot (NOR-64-143) in PIO analysis, assuming that any pre-PIO equalization is abandoned for a pure gain behaviour in the undamped or divergent oscillation. The correct frequency is adopted instantaneously with the stick in phase with the pitch attitude error and 180 degrees out of phase with the attitude. The stick is not always moved so purely in practice, but very often the pilot can be seen to apply the stick a little too quickly and then hold it while waiting for the pitch rate reversal before also reversing the stick.

The tendency of a configuration to PIO can therefore be assessed without using a pilot model by empirically establishing the range of characteristics found in actual PIO examples. Enough have now been published to do this with considerable accuracy. An important feature at the PIO frequency is the response gain. If this is small enough, dangerous oscillation amplitudes cannot occur, and PIO has not been found where this is less than 0.1 degrees per pound of stick force. This is not a completely necessary condition but it is a highly desirable design aim.

MIL-STD-1797A
APPENDIX A

PIO's have occurred most frequently, though not exclusively, in the landing flare. The connection with the commonplace stick pumping is well established. This subconscious excitation of pitch acceleration in the flare occurs near the same frequency as a PIO. If the attitude in the oscillation suddenly intrudes into the pilot's awareness, a ready-made PIO is already in existence. The lower the frequency, the larger is the attitude oscillation at the usual acceleration amplitude of about 6 deg/sec^2 , and the more likely the conversion becomes. This indicates strongly the desirability of a high crossover frequency through the PIO region.

While an oscillation amplitude of less than 0.5 degree in the flare will not usually be noticed, the one significantly more than a degree is very likely to, this or the corresponding pumping/PIO frequency is not an ideal parameter for correlation. The most successful has proved to be the rate at which the pitch attitude phase lag increases with frequency in the PIO lag crossover region, equally applicable to the landing or to target tracking tasks. By the nature of the attitude frequency response, if the crossover frequency is low and the attitude attenuates only slowly towards the crossover region, the phase rate is large. If the frequency is high and there is substantial attenuation, the phase rate is low. The gain margin is increased, the stick pumping amplitude is reduced and the tendency to PIO is decreased automatically by designing a low phase rate into the control laws.

This simple attitude parameter alone is almost sufficient to quantify the tendency to high order PIO, and it correlates well with available examples of high order PIO. Figure 77 shows the trends, with an accuracy good enough to allow Level 1, 2 and 3 boundaries to be drawn, if desired. For the control law designer it is enough to aim for a phase rate of less than 100 degrees per cps and attitude response phase rate of less than 100 degrees per cps and attitude response smaller than 0.1 deg/lb at the crossover. These characteristics are a natural feature of low order aircraft whose attitude phase lag exceeds ISO degrees due to the power control and so could in principle suffer from PIO, yet do not. Early examples of bobweight PIO were high-order in kind and are found to have had very large phase rates with the stick free.

For most combat aircraft configuration, consideration of normal acceleration effects does not improve the PIO analysis. The g at the cockpit is usually attenuated and phase advanced relative to the cg and will often not reach the 180 degrees lag necessary for piloted instability. Human sensing of the g response is poor and at the initiation of the PIO the g may be undetectable. In large aircraft with the cockpit far ahead of the cg, the heave can have a significant effect and has to be taken into account in the dominant requirement to optimize the pitch attitude behaviour.

Although the attitude to stick force response gain is significant in PIO, there is little evidence that a damper modifies the pilot's stick phasing in a PIO and only the stiffness component should be used. Where PIO tendencies exist, they will be exacerbated by a high stick stiffness. Gradients of 5 to 8 lb/in with forces of 2 to 2.5 lb/g have proved to be extremely satisfactory for [fly-by-wire] aircraft. Designed to the phase rate and gain margin criteria discussed above, the attitude gain phase rate and gain at the PIO frequency is only some 0.5 deg/in. In AFFDL-TR-74-9 case 4D had high phase rate and low PIO gain margin. With a gradient of 22 lb/in and 6.7 lb/g it had an attitude gain of 7 deg/in at the PIO frequency. Not surprisingly it suffered from continuous pitch oscillations and severe tracking PIO, earning ratings of 9 and 10.

MIL-STD-1797A
APPENDIX A

The boundaries in the frequency response criteria of figure [75] are based directly on these considerations and will eliminate high order PIO. Low order PIO will also be eliminated by the optimization criteria given above.

SUPPORTING DATA

AFFDL-TR-77-57 illustrated several examples of PIO-prone aircraft. One example is similar to the YF-17 as simulated on the USAF/Calspan variable stability T-33. The θ and a_{zp} transfer functions are given as follows⁴;

$$\frac{\theta}{F_s} = \frac{K_{\theta}(2)(2.3)[.44,11.]}{(0)(5)[.89,1.98][.7,4.0]}$$

$$\frac{a_{zp}}{F_s} = \frac{K_a(2)(2.3)[.08,5.04][.44,11.]}{(.9)(5.)[.89,1.98][.7,4]}$$

The following discussion is quoted from AFFDL-TR-77-57.

Figure 92 is a Bode plot of the airplane's pitch attitude dynamics, $\theta/F_s(j\omega)$. Assuming that the crossover frequency will lie between 2 and 4 rad/sec, it is clear that the aircraft dynamics are roughly of the form K/s^2 in this region. As a rule, dynamics of this sort will lead to lightly damped closed-loop oscillations and degraded pilot opinion ratings. An inspection of the data base of AFFDL-TR-65-15 and a modicum of iteration suggest that a reasonable model for pilot dynamics in pitch tracking would be

$$Y_p(j\omega) = K_p(2.5j\omega + 1)e^{-.385j\omega}$$

A Bode plot of the open-loop system dynamics $Y_{OL} = Y_p(\theta/F_s)$ is also shown on figure 92. Figure 92 indicates that the absolute maximum crossover frequency with the $Y_p(j\omega)$ is 3.3 rad/sec. Accordingly, $\omega_c = 2.9$ was selected and is assumed to be consistent with what would be measured in actual flight; this, yields a small phase margin (about 16 deg). Obviously, even small increases in pilot gain will rapidly degrade system stability. This result appears to be consistent with the evaluation pilots' comments about the poor pitch handling qualities of this configuration in flight tests (AIAA Paper 75-985).

⁴ $(1/T) \rightarrow [s + 1/T]$; $[\zeta, \omega] \rightarrow [s^2 + 2\zeta\omega s + \omega^2]$

MIL-STD-1797A
APPENDIX A

The corresponding closed-loop dynamics, $\theta/\theta_c = Y_{CL}$, are shown on figure 92 for $\omega_c = 2.9$. Obviously the closed-loop system is extremely resonant at this condition. It is evident by inspection that the resonant peak of θ/θ_c will dominate the a_{zp} power spectrum. The corresponding damping ratio for this mode is approximately 0.03. Thus, by the simplified criterion for subjective predictability, it must be concluded that PIO cannot be ruled out on the basis of pitch control handling qualities. The resonance frequency ω_R is 3.0 rad/sec for the given $Y_p(j\omega)$. More pilot lead and higher pin would increase ω_R somewhat.

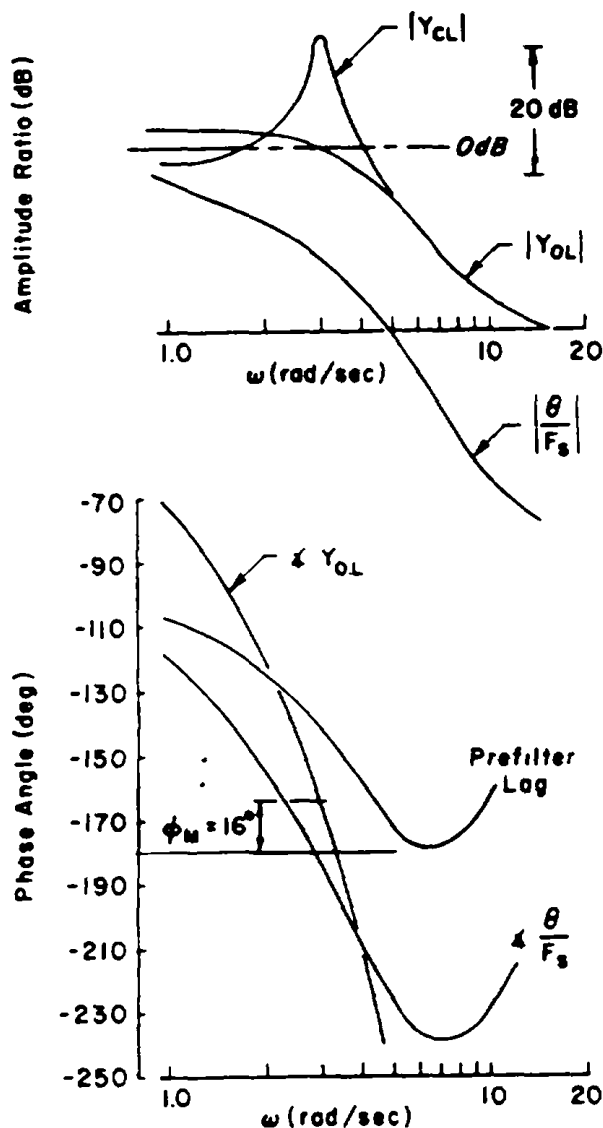

FIGURE 92. YF-17 pitch attitude dynamics (AFFDL-TR-77-57).

By the assessment rules of AFFDL-TR-77-57, the analysis must now proceed to an investigation of stability of the $a_{zp} \rightarrow F_s$ loop when the pilot's gain is adjusted to make $\omega_c = \omega_R$. The total $a_{zp} \rightarrow F_s$ system phase (ϕ) versus frequency is plotted on figure 93 in accordance with the rules of the PIO theory. The pilot time delay was assumed to be 0.25 seconds. At $\omega = 3.0$ we have $\phi = -205$ deg, $180 + \phi = -25$ deg (the system phase margin), and we see that the acceleration-closed loop is unstable. Thus, longitudinal PIO can be initiated provided that the pilot attempts to control a_{zp} .

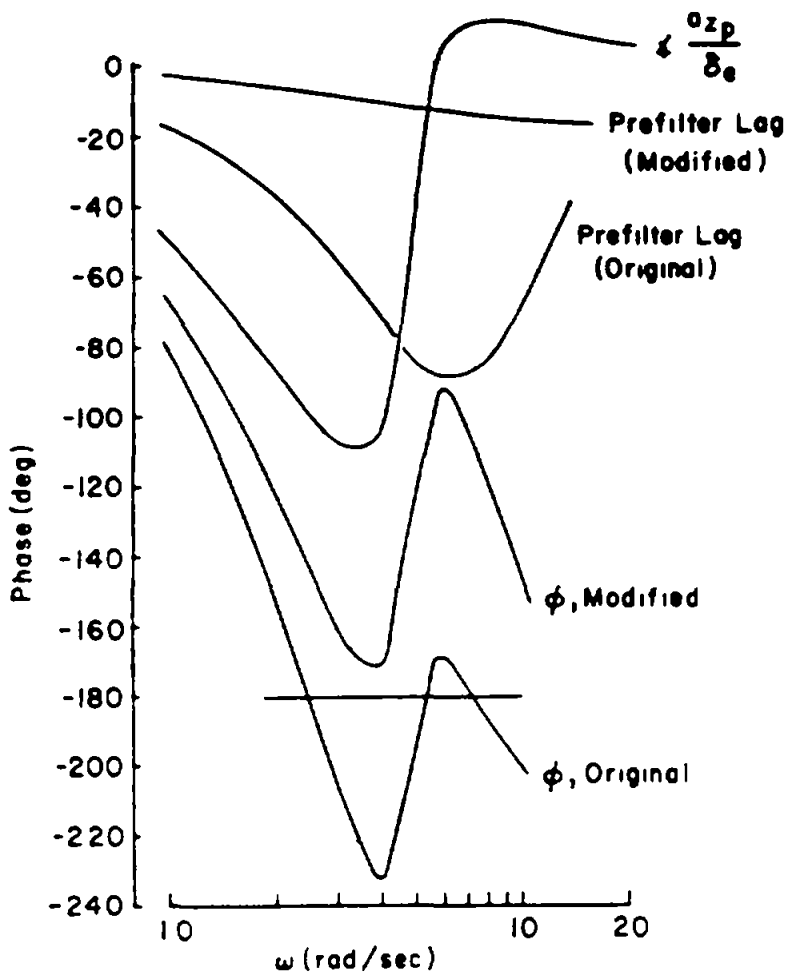

FIGURE 93. YF-17 acceleration control system dynamics (AFFDL-TR-77-57).

The ratio $|a_{zp} / \dot{\theta}| (3.0j)$ is 0.031 g/deg/sec. Thus by present theory we would be justified in concluding PIO would be likely with this airplane and control system.

The actual normal acceleration dynamics simulated with the NT-33A yield $|a_{zp} / \dot{\theta}| (3.0j) = 0.0213$ g/deg/sec. This is about twice the criterion value of 0.012; on that basis it can be concluded that errors in the simulation of a_{zp} motion amplitude were probably of no consequence.

The PIO frequency and amplitude obtained with the NT-33A simulation are unpublished. It is known from informal communication between the writer of AFFDL-TR-77-57 and Calspan staff members that the PIO frequency was approximately 1/2 cps. It may therefore be concluded that this analysis (and, as a consequence, the present theory) is supported by the flight test results.

REQUIREMENT LESSONS LEARNED

The example given in the Supporting Data showed that the criterion successfully predicted a PIO. But, what if we checked the pitch dynamics against the equivalent systems or bandwidth criteria of 4.2.1.2? A lower order equivalent system was not run for the dynamics presented. However, defining the short-period damping as 0.89 (as is done in AFFDL-TR-77-57) may not be appropriate considering the significant number of higher-order modes that exist. The bandwidth criterion can be checked directly from figure 92 (θ/F_s) with the following results:

MIL-STD-1797A
APPENDIX A

$$\omega_{BW} = 1.3 \text{ rad/sec}$$

$$\tau_p = 0.16 \text{ sec}$$

Plotting these values on figure 56 shows that the aircraft is very close to the Level 3 region of the flying qualities boundary. Hence the conclusion that the aircraft is PTO prone is not surprising. In fact, the resonant peak in Y_{CL} of figure 92 is a direct consequence of these particular values of ω_{BW} and τ_p . Nonetheless, it may be desirable to retain the criteria to emphasize the notion that a_{zp} may well be a key parameter for identifying PIO-prone aircraft. Also, it may be possible for a configuration to pass the lower-order equivalent system or bandwidth criterion and be caught by the PIO criterion.

A very good summary report on PIOs is given in NOR-64-143. The following paragraphs from that reference discuss the causes of PIOs:

There are several ways of looking at the causes of a PIO. One is to catalog all the PIO situations ever recorded, including all the necessary subsystem details, etc., and then to say that each combination of vehicle and subsystem when combined with the pilot was the cause of a PIO. Another way is to note that certain system phenomena such as stick-force-to-control-deflection hysteresis often lead to PIO when other conditions are right. A third way, and one which seems to transcend the difficulties of the previous two, is to say that certain inherent human physical limitations are the basic cause for any PIO. This is not to degrade the human pilot's role but, instead, to emphasize it, because it is unlikely that any black-box could be devised which is as clever and effective in coping with unmanageable controlled elements as a skilled pilot. Were it not for the pilot's versatile gain adaptability, many flight conditions would be unstable. But there is a limit to the rapidity with which the human can adapt, and this can sometimes lead to a PIO.

When referred to the pilot, then, the basic causes of PIO seem to fall into the following categories:

1. Incomplete pilot equalization
 - a. Incomplete training
 - b. Inappropriate transfer of adaptation (i.e., carry over of improper techniques from another aircraft)
2. Excessive demands on pilot adaptation
 - a. Required gain, lead, or lag lie outside the range of normal capabilities
 - b. Rate of adaptation is too slow to preclude oscillation
 - c. Inadequate capability to cope with system nonlinearities
3. Limb-manipulator coupling
 - a. Impedance of neuromuscular system (including limb) on control stick or pedals changes feel system dynamics
 - b. Motion-induced limb force feedback (e.g., arm becomes a bobweight)

Table XIV, from NOR-64-143, lists some known PIO cases and their causes for then-current (early 1960s) aircraft. The causes are equally relevant for modern aircraft, and the lessons learned from the cases listed are valuable in preventing PIOs.

MIL-STD-1797A
APPENDIX A

5.2.2 Pilot-induced pitch oscillations-verification.

Verification shall be by analysis, simulation and flight test.

VERIFICATION RATIONALE (5.2.2)

It would be an easy matter for SPO engineers to ascertain compliance with this paragraph without relying on pilot/vehicle analysis methods. For example, ω_R and the specified phase lag can easily be obtained from simulator or in-flight time histories (ground-based simulations will not show up acceleration-dependent PIO tendencies). Nonetheless, analytical estimates can -- and should - be made by the airframe manufacturer as part of the design evolution. For flight evaluation, the PIO rating scale of figure 12 will be helpful.

VERIFICATION GUIDANCE

The user should refer to Chapters IV, V, and VI of AFFDL-TR-77-57 when applying the quantitative requirement. PIOs are associated with precise tracking as in air-to-air gunnery, formation flying, flare, and touchdown. PIOs observed in flight are often not obtained in ground-based simulators, even ones with some motion. Tight, aggressive pilot control action will tend to bring on any PIO tendencies. High sensitivity to control inputs is often a factor. Some pilots are more PIO-prone than others, depending upon piloting technique.

VERIFICATION LESSONS LEARNED

These requirements are an attempt to catch and correct any PIO tendencies as early as possible in the design, when changes are easiest and least costly to make. They also have been found helpful in identifying PIO tendencies in flight and determining fixes.

MIL-STD-1797A

APPENDIX A

TABLE XIV. Classification of some known PIO cases (from NOR-64-143).

Examples shown as: SPECIES (Aircraft); Critical Subsystem*; Critical Flight Condition**: Remarks

CLASS	TYPE		
	I. LINEAR	II. SERIES NONLINEAR ELEMENTS	III. SUBSIDIARY FEEDBACK NONLINEAR ELEMENTS
PITCH	<p><u>IMPROMPER SIMULATION</u>; D, V; a: Abnormally high value of $1/T_{02}$ and low $(\zeta\omega)_{sp}$ led to zero ζ_{sp} when regulating large disturbances.</p> <p><u>GCA-INDUCED PHUGOID</u> (C-97); D; c, b: Lag from radar-detected error to voice command led to unstable closed-loop phugoid mode.</p> <p><u>ARM ON STICK</u> (A4D-1, T-38A); F; a: Arm mass increases feel system inertia, leads via B feedback to unstable coupling with short-period dynamics if pilot merely hangs loosely onto stick after a large input.</p>	<p><u>PORPOISING</u> (SB2C-1); F; c: Hysteresis in stick versus elevator deflection resulted in low-frequency speed and climb oscillations.</p> <p><u>J. C. MANEUVER</u> (F-86D, F-100C); F, S; a: Valve friction plus compliant cabling resulted in large oscillations at short period.</p> <p><u>PITCH-UP</u> (XF-104, F-101B, F-102A); V; c: Unstable kink in $M(\alpha)$ curve led to moderate-period oscillations of varying amplitudes (depending on extent and nature of the kink) during maneuvers near the critical angle-of-attack.</p> <p><u>LANDING PIO</u> (X-15); S; b: Closed loop around elevator rate limiting caused moderate oscillations at short-period.</p>	<p><u>BOBWEIGHT BREAKOUT</u> (A4D-1, T-38A); F, B; a: At high-g maneuvers the bobweight overcomes system friction and reduces apparent damping of the aircraft in response to force inputs, resulting in large oscillations at short-period.</p> <p><u>LOSS OF PITCH DAMPER</u></p>
LATERAL-DIRECTIONAL	<p><u>ω_p/ω_d EFFECT</u> (X-15, NT-33A, F-101B, F-106A, KC-135A, B-58); V; c: Zeros of roll/aileron transfer function are higher than Dutch roll frequency, $\omega_p/\omega_d > 1.0$, leading to closed-loop instability at low ζ_d conditions.</p> <p><u>BORESIGHT OSCILLATIONS</u> (F-5A); D, V; c: Spiral roll mode driven unstable if roll information is degraded during gunnery.</p>		<p><u>LOSS OF YAW DAMPER</u></p>
YAW	<p><u>FUEL SLOSH SNAKING</u> (KC-135A, T-37A); V; c: Fuel slosh mode couples with Dutch roll mode when rudder used to stop yaw oscillation.</p>	<p><u>TRANSONIC SNAKING</u> (A3D); V, F; a,c: Separation over rudder causes control reversal for small deflections, leading to limit cycle if rudder used to damp yaw oscillations.</p>	
ROLL	<p>NONE KNOWN</p>	<p><u>PILOT-INDUCED CHATTER</u> (F-104B); A; c: Small limit cycle due to damper aggravated whenever pilot attempted to control it.</p>	

* Critical Subsystems:

D = Display
 F = Feel system (except B)
 B = Bobweight
 S = Power servo actuator
 V = Vehicle (airframe)
 A = Augmentor (damper)

** Critical Flight Conditions:

a = Low altitude, near-sonic Mach
 b = Landing approach and takeoff
 c = Cruise

MIL-STD-1797A
APPENDIX A

4.2.3 Residual pitch oscillations.

In calm air, any sustained residual oscillations shall not interfere with the pilot's ability to perform the tasks required in service use of the aircraft. For Levels 1 and 2, oscillations in normal acceleration at the pilot station greater than _____ will be considered excessive for any Flight Phase. These requirements shall apply with the pitch control fixed and with it free.

REQUIREMENT RATIONALE (4.2.3)

The requirement prohibits limit cycles in the control system or structural oscillations that might compromise tactical effectiveness, cause pilot discomfort, etc. This requirement may be considered a relaxation of the requirement in 4.2.1 for positive damping at all magnitudes of oscillation. Its intent is to recognize thresholds below which damping is immaterial.

REQUIREMENT GUIDANCE

The related MIL-F-8785C requirement is paragraph 3.2.2.1.3.

The recommended value is 0.02g. Given the proper data, this threshold could be made a function of frequency in order to correspond more closely with human perception.

REQUIREMENT LESSONS LEARNED

Allowable normal acceleration oscillations have been decreased to 0.02 g from the 0.05 g of MIL-F-8785C. This is based on flight test experience with the B-1 (AFFTC-TR-79-2), which encountered limit cycle oscillations during aerial refueling, subsonic and supersonic cruise. A primary contributor was identified to be mechanical hysteresis in the pitch system. According to AFFTC-TR-79-2, "Flying qualities were initially undesirable due to this limit cycle." Normal acceleration transients in cruise were about 0.05 - 0.12 g, as figure 94 shows. The limit cycle was eliminated by installation of a mechanical shaker (dither) vibrating at 20 Hz.

5.2.3 Residual pitch oscillations-verification.

Verification shall be by analysis, simulation and flight test

VERIFICATION RATIONALE (5.2.3)

Limit cycle amplitude depends on characteristics of the actual hardware and software, and so may be different in simulations than in actual flight. Measurements of normal acceleration at the pilot's station should be made in the course of test flight to meet the other flying quality requirements.

VERIFICATION GUIDANCE

Residual oscillations are limit cycles resulting from nonlinearities such as friction and poor resolution. Negative static stability will contribute and low damping may augment the amplitude. Thus high speed, high dynamic pressure or high altitude may be critical. Residual oscillations are most bothersome in precision tasks.

VERIFICATION LESSONS LEARNED

MIL-STD-1797A
APPENDIX A

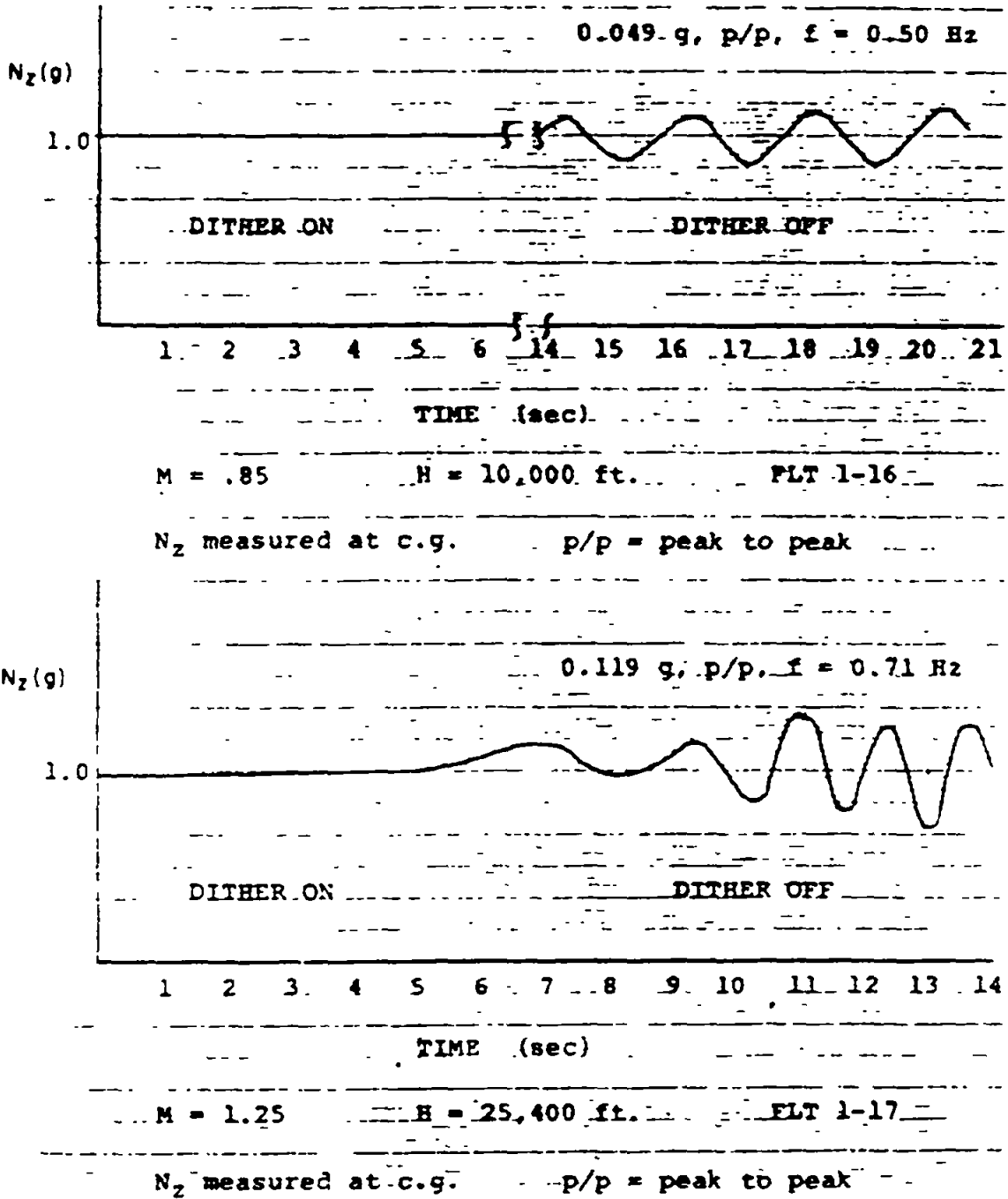

FIGURE 94. Effect of dither on B-1 limit cycle oscillations (from AFFTC-TR-79-2).

4.2.4 Normal acceleration at pilot station.

Normal acceleration at the pilot station due to pitch control inputs shall have the following characteristics:

REQUIREMENT RATIONALE (4.2.4)

The dynamic normal acceleration response at the pilot station to the pitch controller should not be objectionably large or of a confusing nature in terms of the pilot's perception of pitch rate response to a pitch controller input.

REQUIREMENT GUIDANCE

This is a new requirement whose need is apparent, though insufficient information exists to formulate recommended criteria. Unusual pilot locations can adversely affect handling qualities. A prominent example is the Space Shuttle, in which confusing acceleration cues played a part in pilot-induced oscillations encountered during approach and landing tests (NASA-CR-163108). In that vehicle the pilot's station is noticeably aft of the instantaneous center of rotation for elevator inputs, so when he pulls back on the controller he first sinks noticeably before rising.

In most cases, the pilot station is forward of the instantaneous center of rotation for pilot pitch control inputs, giving an initial impulse $1_x \cdot \dot{q}_0$ in the correct direction and a transfer function (short-term approximation)

$$\frac{a_{zp}}{F_s} = \frac{K[s^2 + 2\zeta_a \omega_a s + \omega_a^2]}{[s^2 + 2\zeta_{sp} \omega_{sp} s + \omega_{sp}^2]}$$

Generally $\omega_a > \omega_{sp}$, but it is conceivable this may not hold universally. Figure 95 shows no ill effects from $\omega_a = 1.25$, $\omega_{sp} < 1$ for simulated approach and landing of a very large transport. The initial a_z seems to help overcome -- to an extent -- any adverse time-delay effects, but a limit might be reached where the initial response is too abrupt.

Blended direct-lift control has not always produced the expected gains. The F-16 CCV and AFTI maneuver enhancement modes were well liked for both their quickened path response and their gust alleviation. But evaluating washed-out spoiler blended with elevator control, Hanke, Wilhelm and Lange (AGARD-CP-333) found deteriorating ratings with increasing DLC gain. Evidently, if the pilot must close an inner attitude loop, he needs some phase separation between pitch and path responses in order to distinguish the two during the approach phase of landing. For the classical case, this separation is given by $\tan^{-1} \omega_{sp} T_{02}$. Another in-flight evaluation, of approaches and actual landings with a rate command/attitude hold system, failed to realize the improved ratings that DLC had produced in ground-based simulations--it has been argued whether the disturbing heave motion associated with stick, motions was attributable to the basic DLC or was an artifact of the simulation (Mooij and Van Gool, AGARD-CP-333)

REQUIREMENT LESSONS LEARNED

MIL-STD-1797A
APPENDIX A

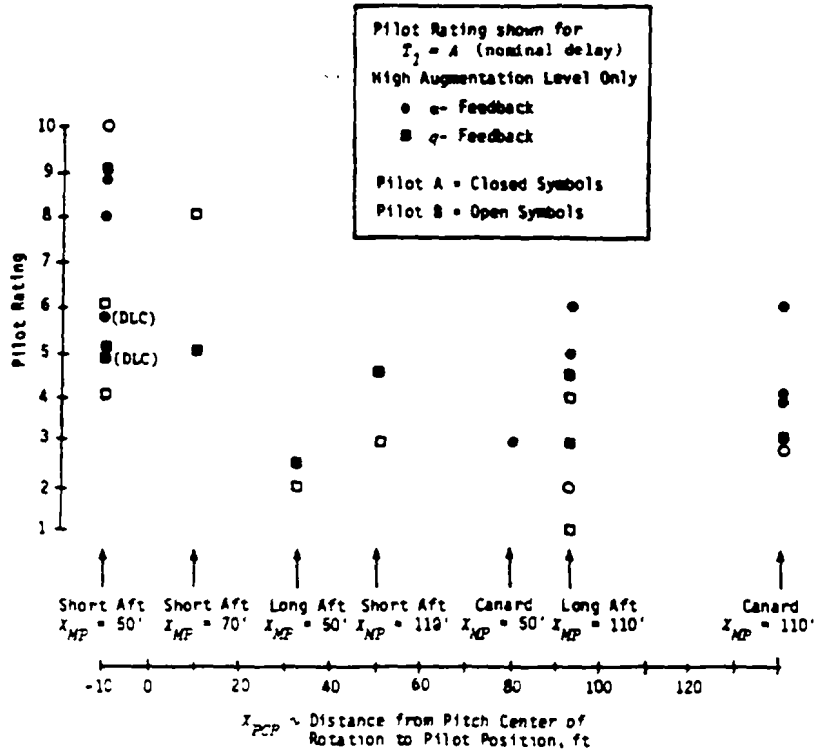

FIGURE 95. Pilot rating vs pilot position - center of rotation (from AFWAL-TR-81-3118).

5.2.4 Normal acceleration at pilot station-verification.

Verification shall be by analysis, simulation and flight test.

VERIFICATION RATIONALE (5.2.4)

Any difficulty will be apparent in tasks requiring very tight control of flight path.

VERIFICATION GUIDANCE

The effective control arm is given by $l_c / \bar{c} = C_{m_\delta} / C_{L_\delta}$, positive forward from the c.g. (negative for an aft tail).

The instantaneous center of rotation for control inputs is at $l_{CR} = Z_\delta / (M_\delta + Z_\delta M_{\dot{w}}) \doteq Z_\delta / M_\delta$, positive forward of the c.g. [$Z_\delta = -\bar{q} S C_{L_\delta} / m$, $M_\delta = \bar{q} S \bar{c} C_{m_\delta} / I_y$].

For the two-degree-of-freedom approximation (assuming constant speed) the normal-acceleration transfer-function numerator for control inputs is

MIL-STD-1797A
APPENDIX A

$$N_{\delta}^{az} = -g \frac{C_{L\delta}}{C_{L1}} \left(1 - \frac{l_x}{l_{CR}} \right) \left[s^2 - \frac{g/V}{2k_y^2 C_{L1}} \left(\frac{C_{mq} + C_{m\dot{\alpha}} - \frac{2l_x l_c}{\bar{c}^2} \left(1 - \frac{\bar{c}}{l_c} \frac{C_{m\alpha}}{C_{N\alpha}} \right) C_{N\alpha}}{1 - l_x / l_{CR}} \right) s - \frac{g l_c}{k_y^2 \bar{c}^2} \frac{C_{N\alpha}}{C_{L1}} \left(\frac{1 - \frac{\bar{c}}{l_c} \frac{C_{m\alpha}}{C_{N\alpha}}}{1 - l_x / l_{CR}} \right) \right]$$

MIL-STD-1797A
APPENDIX A

at a distance l_x forward of the c.g., where $k_y = l_y / (m \bar{c}^2)$. Fuselage bending might also affect the response.

VERIFICATION LESSONS LEARNED

With the USAF-Calspan TIFS (Total In-Flight Simulator) airplane, attempts to control the value of $1/T_{\theta_2}$ via direct lift control have excited a structural mode which was very evident in the evaluation cockpit at high DLC gain. In one recent case the result was a long time delay followed by a very abrupt response at the cockpit, which the pilot rated unacceptable or uncontrollable. Since all aircraft have some flexibility, the lesson is to be alert for aeroservoelastic effects on flying qualities as well as on the structure and the flight control system.

MIL-STD-1797A
APPENDIX A

4.2.5 Pitch trim changes.

The pitch trim changes caused by operation of other control devices shall not be so large that a peak pitch control force in excess of 10 pounds for center-stick controllers or 20 pounds for wheel controllers is required when such configuration changes are made in flight under conditions representative of operational procedure. Generally, the conditions of table IV will suffice for determination of compliance with this requirement. With the aircraft trimmed for each specified initial condition, and no retrimming, the peak force required to maintain the specified configuration change shall not exceed the stated value for a time interval of at least 5 seconds following the completion of the pilot action initiating the configuration change. The magnitude and rate of trim change subsequent to this time period shall be easily trimmable by use of the normal trimming devices. These requirements define Level 1. For Levels 2 and 3, the allowable forces are increased by 50 percent.

REQUIREMENT RATIONALE (4.2.5)

These frequently encountered pitch trim changes, if too large, can add to pilot workload at critical times during a mission.

REQUIREMENT GUIDANCE

The related MIL-F-8785C paragraph is 3.6.3.1.

Table XV gives the recommended conditions (For aircraft with variable-sweep wings, additional requirements should be imposed consistent with operational employment of the vehicle. Thrust reversing and other special features also need to be considered). These are the trim changes that, when larger than the limits specified, have been bothersome in the past. Crossfeeds and feedbacks in the stability, and control augmentation system generally will reduce the magnitude of these trim changes. Wing downwash and vertical placement of the engines are two of the determining factors. For thrust reversing, configuration-dependent aerodynamics play an important role.

4.1.13 gives additional general trim requirements.

REQUIREMENT LESSONS LEARNED

The direction of the trim change can also be important, producing either helpful or unfavorable coupling. In any case the magnitude should not be excessive.

5.2.5 Pitch trim changes-verification.

Verification shall be by analysis, simulation and flight test.

VERIFICATION RATIONALE (5.2.5)

The evaluation should be made in the manner expected in operational practice, rather than necessarily holding everything else constant.

VERIFICATION GUIDANCE

Initial trim conditions are listed in table XV.

VERIFICATION LESSONS LEARNED

MIL-STD-1797A
APPENDIX A

TABLE XV. Pitch trim change conditions.

	Flight Phase	Initial Trim Conditions					Configuration Change	Parameter to be held constant
		Attitude	Speed	Landing Gear	High-lift Devices & Wing Flaps	Thrust		
1	Approach	h_{omin}	Normal pattern entry speed	Up	Up	TLF	Gear down	Altitude and airspeed*
2				Up	Up	TLF	Gear down	Altitude
3				Down	Up	TLF	Extend high-lift devices and wing flaps	Altitude and airspeed*
4				Down	Up	TLF	Extend high-lift devices and wing flaps	Altitude
5				Down	Down	TLF	Idle thrust	Airspeed
6			V_{omin}	Down	Down	TLF	Extend approach drag device	Airspeed
7				Down	Down	TLF	Takeoff thrust	Airspeed
8	Approach		V_{omin}	Down	Down	TLF	Takeoff thrust plus normal cleanup for wave-off (go-around)	Airspeed
9	Takeoff			Down	Take-off	Take-off thrust	Gear up	Pitch attitude
10			Minimum flap-retract speed	Up	Take-off	Take-off thrust	Retract high-lift devices and wing flaps	Airspeed
11	Cruise and air-to-air combat	h_{omin} and h_{omax}	Speed for level flight	Up	Up	MRT	Idle thrust	Pitch attitude
12				Up	Up	MRT	Actuate deceleration devices	
13				Up	Up	MRT	Maximum augmented thrust	
14			Speed for best range	Up	Up	TLF	Actuate deceleration device	

*Throttle setting may be changed during the maneuver.

- Notes: - Auxillary drag devices are initially retracted, and all details of configuration not specifically mentioned are normal for the Flight Phase.
- If power reduction is permitted in meeting the deceleration requirements established for the mission, actuation of the deceleration device in #12 and #14 shall be accompanied by the allowable power reduction.

MIL-STD-1797A
APPENDIX A

4.2.6. Pitch axis response to other inputs.

4.2.6.1 Pitch axis response to failures, controls free.

With controls free, the aircraft motions due to partial or complete failure of any subsystem of the aircraft shall not exceed the following limits for at least _____seconds following the failure: _____.

REQUIREMENT RATIONALE (4.2.6.1)

Quantitative limits are needed to avoid pilot workload increases and flight safety problems.

REQUIREMENT GUIDANCE

The applicable MIL-F-8785C paragraph is 3.5.5.1.

Recommended limits on transient motions within the first 2 seconds following failure are as follows:

Levels 1 and 2 (after failure): ± 0.5 g incremental normal acceleration at the pilot's station, except that neither stall angle of attack nor structural limits shall be exceeded. In addition, for Category A, vertical excursions of 5 feet.

Level 3 (after failure): No dangerous attitude or structural limit is reached, and no dangerous alteration of the flight path results from which recovery is impossible.

These limits were taken from paragraph 3.5.5.1 of MIL-F-8785C. Although the intent of the requirement is to insure that dangerous flying qualities never result, there may be some benefit to a noticeable transient after a failure, or after transfer to an alternate control mode, in order to alert the pilot to the change. That possibility is left to the designer without explicit direction to minimize transients. This requirement also places quantitative limits on the altitude change, effectively restricting the 2-second average acceleration in addition to the peak value.

REQUIREMENT LESSONS LEARNED

The revision to MIL-F-8785C followed the recommendations of Systems Technology Inc. TR-189-1: the authors noted that the allowable transient levels of MIL-F-8785B were consistent with failure probability considerations, but not with flying qualities considerations. Level 2 had a lower probability of occurrence than Level 1 and was permitted to have larger transient responses; however, Level 2 is a poorer handling qualities state and cannot accept the larger responses as readily. It was felt that the values in MIL-F-8785C were representative of transients which could be handled with Level 1 flying qualities. Conversely, the low allowable transients of MIL-F-8785B were conducive to soft failures which could lead to catastrophic situations if undetected by the pilot. This comment applied to the B-58, in particular, and led General Dynamics/Ft. Worth to suggest a minimum allowable transient (according to Systems Technology Inc TR-189-1). This has not been incorporated into this document, but should be a consideration in the design process.

5.2.6.1 Pitch axis response to failures, control free-verification.

Verification shall be by analysis, simulation and flight test.

VERIFICATION RATIONALE (5.2.6.1)

Some failures may be considered too dangerous to flight test. Where final demonstration is by simulation, flight-validated aerodynamic data should be used with actual flight hardware and software, loaded as necessary to replicate the response in flight.

MIL-STD-1797A
APPENDIX A

VERIFICATION GUIDANCE

Worst-case flight conditions should be identified and tested. High control effectiveness, authority and gain; low or negative static stability or damping; low weight and inertia will tend to make the transients larger. Generally a dynamic analysis is needed, but constant speed can be assumed for the two-second period of time.

$$M_{\delta} = \bar{q} S \bar{c} C_{m_{\delta}} / I_y = C_{m_{\delta}} g \bar{c} / (C_{L_1} K_y^2)$$

where $C_{L_1} = W/qS$, K_y is the radius of gyration (dimensional) in pitch.

VERIFICATION LESSONS LEARNED

MIL-STD-1797A
APPENDIX A

4.2.6.2 Pitch axis response to configuration or control mode change.

The transient motions and trim changes resulting from configuration changes or the intentional engagement or disengagement of any portion of the primary flight control system in equilibrium flight due to pilot action shall be such that dangerous flying qualities never result. With controls free, the motion transients resulting from these situations shall not exceed the following limits for at least seconds following the transfer: These requirements apply only for Aircraft Normal States (4.1.6).

REQUIREMENT RATIONALE (4.2.6.2)

Pitch transients due to intentional mode switching are distracting. If the transients are too large, pilots object.

REQUIREMENT GUIDANCE

The related MIL-F-8785C paragraphs are 3.5.6 and 3.5.6.1.

Recommended values for transient motion limits within the first 2 seconds following transfer:

Within the Operational Flight Envelope: ± 0.05 g normal acceleration at the pilot's station

Within the Service Flight Envelope: ± 0.05 g at the pilot's station.

Since the intent of a flight control system is to improve the aircraft response characteristics--whether measured by improved flying qualities or by increased mission effectiveness--any system which can be chosen by the pilot should not cause noticeable transient motions. There has been some speculation as to whether a small transient motion is or is not desirable. The argument for an intentional transient is that inadvertent pilot switching of autopilot modes is less likely if accompanied by a noticeable transient motion.

MIL-F-8785B allowed 0.05 g normal acceleration. This was increased to 0.10 g in MIL-F-8785C, in order to allow if not encourage designers to provide some noticeable transient (see AFWAL-TR-81-3109). In AFWAL-TR-81-3109 an accident was cited wherein the pilot inadvertently bumped off the altitude hold mode (which automatically disengaged when a small force was applied to the control column). The flight recorder showed a 0.04 g transient which went unnoticed by the crew, who were deeply involved in trying to lower a malfunctioning landing gear. However, it is our condition that the undesirable features of transient motions due to mode switching are significant. Furthermore, a distracted crew would probably not notice a transient considerably larger than 0.04 g, especially if there were any turbulence at all. Therefore, we are recommending that the maximum allowable transient of 0.05 g used in MIL-F-8785B be utilized as in MIL-F-8785B and C; two seconds is deemed a reasonable time to allow for the pilot to resume control.

REQUIREMENT LESSONS LEARNED

5.2.6.2 Pitch axis response to configuration or control mode change -verification.

Verification shall be by analysis, simulation and flight test.

VERIFICATION RATIONALE (5.2.6.2)

Configuration changes and control mode changes are to be made by normal means.

MIL-STD-1797A
APPENDIX A

VERIFICATION GUIDANCE

Compliance should be evaluated at likely conditions for mode switching and at the most critical flight conditions. Critical conditions will usually be the corners of the expected operational envelopes (e.g., a SAS for power approach should be switched at the highest and lowest expected airspeeds, at low altitudes). Some factors which determine critical conditions are given in the discussion of 4.2.6.1. Limited analytical and ground-based simulation may be used to supplement actual flight testing, especially in the early stages of development, but flight testing is ultimately required.

VERIFICATION LESSONS LEARNED

MIL-STD-1797A
APPENDIX A

4.2.7 Pitch axis control power

4.2.7.1 Pitch axis control power in unaccelerated flight.

In steady 1-g flight at all Service altitudes, the attainment and holding of all speeds between V_S and V_{max} shall not be limited by the effectiveness of the pitch control.

REQUIREMENT RATIONALE (4.2.7.1)

This requirement is intended to insure that the pilot can maintain equilibrium level flight throughout the flight envelope by normal means.

REQUIREMENT GUIDANCE

The related MIL-F-8785C paragraph is 3.2.3.1.

Controllability at speeds down to the 1-g stall speed is generally deemed necessary for safety, as well as full utilization, of maneuvering aircraft such as the military use. V_{max} , the high-speed boundary of the Service Flight Envelope, must be at least $V_{0_{max}}$; beyond that, it may be set by the contractor, who then must deliver on his promise.

REQUIREMENT LESSONS LEARNED

5.2.7.1 Pitch axis control power in unaccelerated flight-verification.

Verification shall be by analysis, simulation and flight test.

VERIFICATION RATIONALE (5.2.7.1)

Operational flight test will help reveal any deficiencies in pitch control power. Compliance may be demonstrated during measurement of the gradient of pitch control force with airspeed (4.2.1). The controls are to be used in their normal manner, and sideslip minimized (its effect is specified separately).

VERIFICATION GUIDANCE

It is important to explore all corners of the V - h Service Flight Envelope. For example, a transonic tuck or high-speed dives can be critical due to combined aeroelastic and Mach number effects. Extremes of static stability or instability (Mach number, angle of attack, center of gravity) will be critical. Also, hinge moments may limit control deflection and aeroelastic deformations may affect controllability. In 1-g equilibrium level flight, net forces are zero and

$$C_m(\alpha, \delta, M, \bar{q}, c.g.) + (z_T / \bar{c}) [T / (\bar{q}S)] = 0$$

VERIFICATION LESSONS LEARNED

MIL-STD-1797A
APPENDIX A

4.2.7.2 Pitch axis control power in maneuvering flight.

Within the Operational Flight Envelope it shall be possible to develop, by use of the pitch control alone, the following range of load factors: _____. This maneuvering capability is required at constant altitude at the 1-g trim speed and, with trim and throttle settings not changed by the crew, over a range about the trim speed the lesser of 15 percent or 50 kt equivalent airspeed (except where limited by the boundaries of the Operational Flight Envelope).

REQUIREMENT RATIONALE (4.2.7.2)

The pitch axis controller must be sufficiently powerful to produce an adequate range of load factors for maneuvering. Fixed-wing aircraft generally use the pitch controller to affect flight-path changes.

REQUIREMENT GUIDANCE

The related MIL-F-8785C requirement is 3.2.3.2.

Recommended range of load factors:

- Levels 1 and 2: $n_o(-)$ to $n_o(+)$
- Level 3: $n = 0.5 g$ to the lower of:
 - a) $n_o(+)$
 - b) $n = 2.0$ for $n_o(+)$ $\leq 3g$
 $0.5 [n_o(+)$ $+ 1]$ for $n_o(+)$ $> 3g$

The Level 1 and 2 values stem from mission performance needs; while the Level 3 values, which vary to an extent with maneuverability of the aircraft, are related to flight safety.

The requirements for control effectiveness over a ± 15 percent range about the trim speed assure that excessive amounts of pitch-surface-fixed static stability or instability will not limit maneuver capability unduly, for any possible mechanization of the trim system. Where pitch control authority limit normal-acceleration capability, the requirement at off-trim speeds often will be the designing consideration for pitch control effectiveness. At most flight conditions, however, it would be expected that investigation at the nominal V would be sufficient.

This requirement is restricted in application to the Operational Flight Envelope with relaxed requirements for infrequent Failure States. Outside the Operational Flight Envelope, whatever falls out of the design is acceptable, as long as the other control requirements are met (in particular, note the dive pullout and control margin requirements). High supersonic speed and aeroelasticity and large high hinge moments at high dynamic pressure tend to restrict the control capability. The Level 3 requirement assures modest nose-down and nose-up control capability for stabilization as well as for altering equilibrium and maneuvering. AFWAL-TR-83-3015 recommends requiring +1.5g capability for Level 3 at the design dive speed, against the most adverse stabilizer (pitch) trim. That is consistent with some civil aircraft requirements for a 2.5g transport: $0.5 (n_L + 1)$ is 1.75g.

REQUIREMENT LESSONS LEARNED

5.2.7.2 Pitch axis control power in maneuvering flight-verification.

Verification shall be by analysis, simulation and flight test.

VERIFICATION RATIONALE (5.2.7.2)

Flight test techniques are discussed under 5.2.8.1 ...steady-state control force per g.... Operational flight test should be required for final demonstration, in order to assure that any problems are uncovered before introduction into service.

Since demonstration is at constant throttle setting for 1-g equilibrium, these turns will involve loss of either speed or altitude. While in a real sense sustained turn performance is a flying quality, its specification has traditionally been a performance matter. The flying qualities requirement is on steady turn capability, with throttle setting for 1-g flight, in order to avoid trim-change effects which are specified separately. Another term sometimes used is instantaneous turn capability; properly that refers to a dynamic overshoot capability.

VERIFICATION GUIDANCE

Critical flight conditions are indicated by the expression

$$C_m(\alpha, q, \delta, M, \bar{q}, c.g.) + (z_T / \bar{c}) [T/(\bar{q}S)] = 0$$

where T is the 1-g trim thrust (which normally varies little with n_z) and δ is a generic pitch control deflection. Throttle setting is constant.

Measuring α to the principal axis and n_z normal to the flight path.

$$\delta = \frac{-C_{L1}}{C_{m\delta} - \frac{C_{m\alpha}}{C_{L\alpha}} C_{L\delta}} \left\{ \frac{C_{m\alpha}}{C_{L\alpha}} (n_z - 1) + \left[\frac{C_{mq}}{4\mu} - \frac{I_{zp} - I_{xp}}{n_z m \bar{c}^2} \cdot \frac{g\bar{c}}{V^2} \sin \alpha \cos \alpha \right] \left(n_z - \frac{1}{n_z} \right) \right. \\ \left. \mp \frac{H_e}{mV\bar{c}} \cos(\alpha + \varepsilon) \cdot \sqrt{1 - 1/n_z^2} \right\}$$

where $C_{L1} = W/(\bar{q}S)$, $\mu = (W/S)/(g\rho\bar{c})$, sub p indicates principal axes, H_e is the engine angular momentum $I_e\omega_e$, $n_z = \cos\gamma/\cos\phi$ and ε is the inclination of the engine rotor axis to the principal x axis. In the last term, the - is for right turns and the + is for left turns.

Initial flight safety restrictions to 80 percent of limit load may well dictate that the required Level 1 and 2 capability first be demonstrated in the course of the flight loads demonstration program. But the often critical effects of angle of attack can still be investigated earlier, at higher altitude.

VERIFICATION LESSONS LEARNED

MIL-STD-1797A
APPENDIX A

4.2.7.2.1 Load factor response.

The time required to change from one level of normal load factor to another, in pullups and in turning flight, shall be adequate for all maneuvers appropriate to the Flight Phase, for all conditions within the Service Flight Envelope. Overshoots that result from abrupt pullups into the lift- or control-system-limited region of the load factor boundary shall not result in departure or exceedance of load fact or limits.

REQUIREMENT RATIONALE (4.2.7.2.1)

Stating the operational load factor boundaries is not enough to ensure satisfactory maneuvering response. Recent experience with F-5, F-15, and F-16 has shown that for aircraft that are departure resistant, abrupt pitch commands for point and shoot capability or rapid deceleration provide increased mission effectiveness. Use of relaxed static stability can require angle-of-attack/load factor limiters, pitch-rate or angle-of-attack-rate anticipation features to be incorporated into the flight control system to ensure that the limits are not exceeded. The effects of these features must be evaluated to ensure that load-factor response is adequate.

REQUIREMENT GUIDANCE

There is no comparable MIL-F-8785C requirement.

There has been little work done to define satisfactory load-factor onset rates. The following, derived from F-15 flight test data, can be used as a basis for comparison. The F-15 is considered to have good response characteristics.

LOAD FACTOR RESPONSE

ALTITUDE	SPEED RANGE KNOTS EAS	PILOT CONTROL INPUT FROM TRIMMED INITIAL CONDITIONS	RESPONSE
20,000	V=250	Step pitch control input from 1.5g turn to max	Integral under body axis pitch rate curve equals a change in attitude of 32° in 1.1 sec
20,000	300<V<400*	Ramp pitch control input (approx. 10% max control surface rate) from a trimmed 2g turn	From 2g to 7g in 1.8 sec

*NOTE: Between 300 and 400 kts, flight test data on an aircraft with a "g" limiter indicated that it took 3 seconds to go from 2 g's to 6 g's with a step input. The report indicated that this was inadequate for air-to-ground operations. All load factors are measured at the c.g.

REQUIREMENT LESSONS LEARNED

MIL-STD-1797A
APPENDIX A

5.2.7.2.1 Load factor response--verification.

Verification shall be by analysis, simulation and flight test.

VERIFICATION RATIONALE (5.2.7.2.1)

Operational flight tests should be required for final demonstration, in order to assure that any problems are uncovered before introduction into service.

VERIFICATION GUIDANCE

The critical flight conditions are dependent upon the characteristics of the particular vehicle.

VERIFICATION LESSONS LEARNED

MIL-STD-1797A
APPENDIX A

4.2.7.3 Pitch axis control power in takeoff.

The effectiveness of the pitch control shall not restrict the takeoff performance of the aircraft and shall be sufficient to prevent overrotation during all types of takeoff. It shall be possible to obtain and maintain the following attitudes during the takeoff roll: For catapult takeoffs _____.

REQUIREMENT RATIONALE (4.2.7.3)

This requirement is intended to regulate against aircraft that exhibit no apparent pitch response to commands during the takeoff roll until flying speed is reached (V_{min}). These aircraft give no assurance that rotation will be forthcoming, but then tend to "pop off", resulting in overrotation and a necessity for immediate control reversal to avoid stall.

REQUIREMENT GUIDANCE

The related MIL-F-8785C paragraph is 3.2.3.3.

The recommended attitudes are:

For nosewheel aircraft it shall be possible to obtain at $0.9 V_{min}$ the pitch attitude that will result in a lift-off at V_{min} .

For tailwheel aircraft it shall be possible to maintain any pitch attitude up to that for a level thrust line at $0.5 V_S$ for Class I aircraft and at V_S for Classes II, III, and IV.

These requirements shall be met on hard-surface runways. In the event that the aircraft has a mission requirement for operation from unprepared fields, these requirements are to be met on such fields also.

This requirement is based on operational experience, which has shown that the ability to control pitching attitude to achieve the proper attitude for lift-off before V_{min} is necessary for acceptable liftoff at V_{min} .

For catapult takeoff the recommendation is either not applicable (N/A) or

the effectiveness of the pitch control shall be sufficient to prevent the aircraft from pitching up or down to undesirable attitudes in catapult takeoffs at speeds ranging from the minimum safe launching speed to a launching speed 30 knots higher than the minimum.

A related requirement in 4.2.9.1 is intended to provide adequate control of any overrotation tendency without complicated control manipulation.

The requirement on takeoff control power is more important for single-engine aircraft or any multi-engine aircraft which have V_{MCA} (the airborne minimum control speed for a propulsion failure) equal to or less than V_{min} - For multi-engine aircraft where $V_{MCA} > V_{min}$, the requirement could be relaxed to $0.9 V_{MCA}$.

All aircraft will have to operate from hard-surface runways, and therefore hard surfaces were used as the basic requirement. An increased coefficient of friction, however, such as occurs with unprepared fields, increases the elevator effectiveness required for nosewheel aircraft but decreases the effectiveness required of tailwheel aircraft, as can be seen in figure 96.

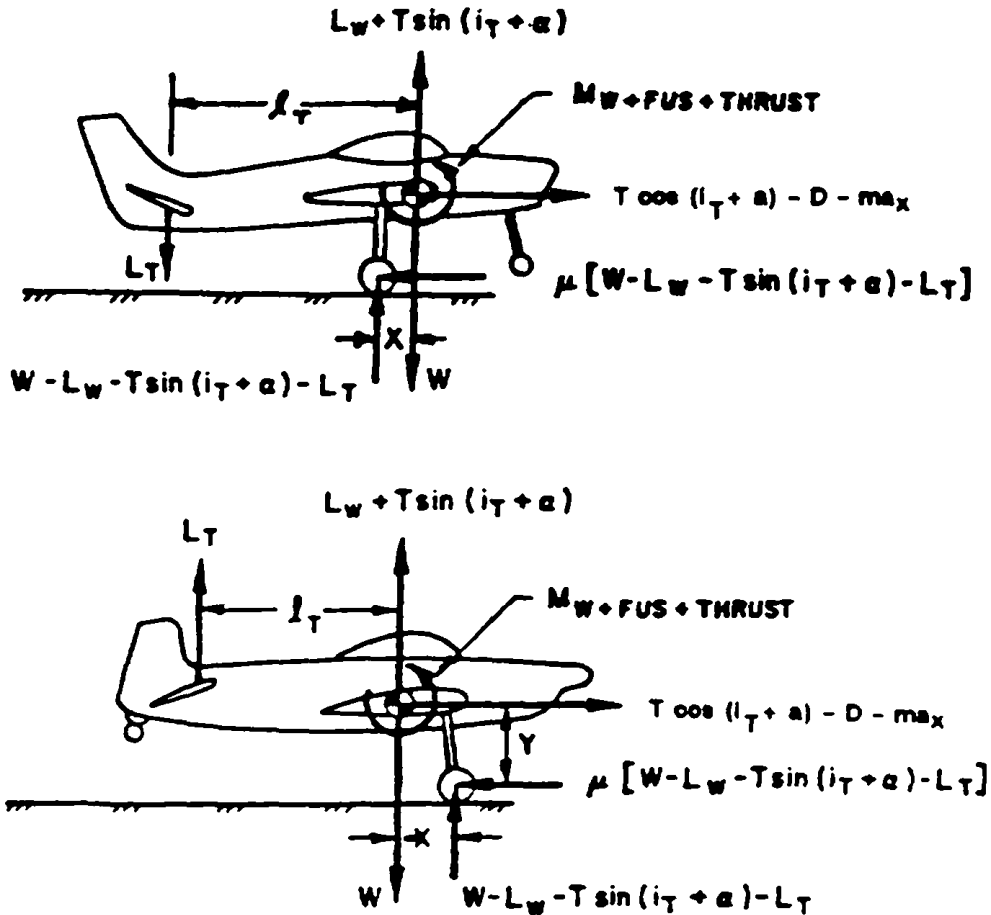

FIGURE 96. Nosewheel and tailwheel lift-off.

The increased rolling friction force gives a nose-down pitching moment about the aircraft c.g. Nose-wheel lift-off speed will increase monotonically with increasing μ , approaching the speed for takeoff in the ground attitude. But tailwheel lift-off speed will decrease the increasing μ until just the application of takeoff thrust will rotate the aircraft at zero speed. Then a different technique would be required. The value $0.9 V_{min}$ is a compromise between early enough indication of controllability and minimization of any tendency to overrotate.

The requirement for control in catapult takeoffs could also be applied to ski-jump takeoffs or use of a jump-strut.

REQUIREMENT LESSONS LEARNED

Single-engine propeller-driven airplanes with a T-tail have been deficient in terms of nosewheel rotation prior to lift-off. As a result, pilot acceptance is very poor. Takeoff performance over an obstacle has been demonstrated to be considerably worse in one T-tail aircraft than in an identical aircraft with a conventional horizontal tail. Delayed lift-off has been attributed to inability to rotate to the takeoff attitude prior to V_{min} . The root cause is that the horizontal tail is out of the propeller wake. Multi-engine aircraft which are not normally lifted off until V_{MCA} (which is usually above V_{min}) do not have as strong a requirement for nose rotation at $0.9 V_{min}$. As an indication, multi-engine airplanes with T-tails have generally been found to be acceptable to pilots.

MIL-STD-1797A
APPENDIX A

On the F-18, the pitch control-deflection range of ± 20 deg. moved with pitch trim position, but could never exceed 24 deg. trailing-edge-up (-) stabilizer. It was possible to mis-set trim for takeoff as that -24 deg. deflection could not be obtained when needed during takeoff. The pilot should always have full deflection available.

The requirement is especially important for turbojet aircraft for which relatively large pitch attitudes are required for lift-off.

5.2.7.3 Pitch axis control power in takeoff-verification.

Verification shall be by analysis, simulation and flight test.

VERIFICATION RATIONALE (5.2.7.3)

Normally the critical test will be to start the rotation, i.e., to at least balance the aircraft with the nosewheel or tailwheel just touching the runway but bearing no load. The main gear extension at this condition, which determines the attitude there, can be found from the lift and load-stroke equations. Control to maintain the takeoff attitude should also be checked, for compliance with the limitation of 4.2.9.1 on control travel during takeoff. In flight test, takeoff performance tests are monitored for flying qualities.

VERIFICATION GUIDANCE

The ability to comply with this requirement should be obvious during operational flight test. Special emphasis should be placed on short-field takeoffs at the maximum forward and aft center-of-gravity limits for lift-off and overrotation, respectively.

From the equation

$$\bar{q} S \bar{c} C_m Tz_T - (W - \bar{q} S C_L - T \sin \xi) (x + \mu y) = 0$$

the lift-off speed is given by

$$\frac{1}{2} \rho V_{LO}^2 = \bar{q}_{LO} = \frac{W}{S} \left[\frac{1 - \frac{T}{W} \left(\sin \xi + \frac{z_T / \bar{c}}{X / \bar{c} + \mu Y / \bar{c}} \right)}{C_L + \frac{C_m}{X / \bar{c} + \mu Y / \bar{c}}} \right]$$

where $\xi = i_T + \alpha$; C_m and C_L are the aerodynamic pitching moment and lift coefficients, in ground effect, of the entire aircraft with takeoff thrust and fully deflected pitch controller, X and Y are the horizontal and vertical distances between the c.g. and the main-gear axle; and μ is the main-gear coefficient of rolling friction.

VERIFICATION LESSONS LEARNED

A balance must be struck between adequate control and overrotation tendency, e.g. the DC-9-80 takeoff performance tests. The test pilot should be alert to avoid tail-strike.

MIL-STD-1797A
APPENDIX A

4.2.7.4 Pitch axis control power in landing.

The pitch control shall be sufficiently effective in the landing Flight Phase in close proximity to the ground that _____.

REQUIREMENT RATIONALE (4.2.7.4)

This requirement insures that the aircraft can be pitched up sufficiently, in ground effect, to achieve the guaranteed minimum landing speed. It also insures that the nosewheel or tailwheel can be gently lowered to the ground during landing rollout.

REQUIREMENT GUIDANCE

The related MIL-F-8785C requirement is 3.2.3.4.

It is recommended that the following requirements be placed on pitch control: during landing flare and rollout with the aircraft trimmed for the minimum recommended approach speed not to exceed $1.3 V_S(L)$:

- a. The geometry-limited touchdown attitude can be achieved at touchdown, or alternatively
- b. The lower of $V_S(L)$ or the guaranteed minimum landing speed [$V_{min}(L)$] can be achieved when flaring from shallow ($\gamma = -3$ deg) and steep ($\gamma = -6$ deg) approaches and
- c. The nosewheel can be gently lowered to the ground at speeds down to $0.9 V_{min}(L)$ or
- d. For tailwheel aircraft, the tailwheel can be gently lowered to the ground at $0.5 V_{min}(L)$ for Class I and $0.75 V_{min}(L)$ for Classes II, III, and IV.

This requirement is to assure adequate pitch control during flare and rollout in ground effect. Elevator effectiveness can be severely degraded in ground effect due to a decrease in downwash caused by presence of the ground plane.

A shallow approach is specified to eliminate the possibility of performing most of the flare out of ground effect. Steep approaches are also required, as they tend to result in firmer touchdowns, making it difficult to keep the nosewheel from slamming to the ground (at forward c.g.). The -6 deg glide path is generally attainable, but could be moderated where the mission usage warrants.

REQUIREMENT LESSONS LEARNED

The Mitsubishi MU-2 (a twin-engine turboprop) is well known for a rapid pitchover immediately at touchdown. Service difficulties with flight instruments and avionics are felt to result from this high shock environment.

The T-46 has no guaranteed landing speed; since its geometry-limited touchdown attitude is greater than its, stall angle of attack, $V_S(L)$, governs. For vehicles augmented to counter degraded static stability, the change in center of rotation from c.g. to main gear at touchdown might result in an uncontrollable situation even if ample control power exists. The original Space Shuttle in-flight control configuration did not provide a stable control loop or fast enough trim capability after main gear touchdown due to the change in, control geometry. It was difficult to lower the nose wheel gently. Control system parameter switching at touchdown was required to correct this. For the Shuttle, then, control effectiveness was more than just moment-producing capability. Some augmented aircraft, the X-29 for one, put up with a great deal of control surface movement while taxiing in order to assure safe transition between ground and air. In any case the stability and control augmentation must function effectively and safely during bounces, hard

MIL-STD-1797A
APPENDIX A

landings, etc., though the aircraft response characteristics are quite different on the ground than when airborne. A canard control surface must not be allowed to stall: a gust at touchdown would be hard on the nose gear.

5.2.7.4 Pitch axis control power in landing-verification.

Verification shall be by analysis, simulation, and flight test.

VERIFICATION RATIONALE (5.2.7.4)

The requirement is now structured so that verification may largely, if not entirely, be a part of maximum-performance landing tests.

VERIFICATION GUIDANCE

No particular guidance is deemed required except to note that the maximum forward c.g. (generally regardless of weight) defines the critical flight condition for nose-up control of a stable airframe. Crosswind may reduce ground effect; flight test should be in calm air. In general, ground effects often do not correlate too well between wind tunnel and flight. See 4.2.8.6.2 guidance for discussion of the related control force requirement.

VERIFICATION LESSONS LEARNED

The MIL-F-8785B/C requirement called for obtaining $V_{S(L)}$, the guaranteed landing speed or the geometry-limited touchdown attitude in close proximity to the ground. By dispelling the inference of steady, level flight, the new recommended requirement is in some respects safer to demonstrate and more closely attuned to operational practice.

4.2.8 Pitch axis control forces

This section contains the control force gradients and limits to be applied to the pitch controller. As a word of introduction, several points must be made which are applicable to all the following force requirements:

- a. In general, the force requirements of MIL-F-8785C are unchanged. This is due in part to lack of good, valid test data to justify changes, even if anecdotal information should suggest such a change is warranted.
- b. The requirements should be considered to be stringently applicable for male pilots only. There is almost no available data for setting requirements for female pilots; a limited amount of data, reviewed below, suggests considerably lower limits would be needed. This of course presents a dilemma in setting limits for aircraft expected to be routinely operated by both male and female pilots.
- c. Maximum forces specified appear in most cases to be quite large for the weaker male pilots for continuous operation.
- d. Effects of stick (or wheel) geometry and position on maximum force capabilities are not explicitly covered in any of the requirements, though it is obvious that control location will affect maximum attainable forces. This can be seen in the discussion that follows.

In a review of past research, Lockenour (AFFDL-TR-78-171) discussed the effect of stick location on push and pull capability (figure 97), and the effect of upper arm angle on push and pull strength for the 5th and 95th percentile male (figure 98). The data shown in these figures are from Human Engineering Guide to Equipment Design for male Air Force personnel in the sitting position. As described in AFFDL-TR-78-171 these data show that:

... one's maximum force capability is not symmetric left and right and varies by about a factor of two for forward and aft stick positions ... pull and push strength differ significantly and ... the 5th and 95th percentile male strengths differ by as much as a factor of three.... Certainly a given stick force at the grip will feel heavier to the pilot for aft stick positions. Also one must be very careful in correlating the acceptability of stick forces for various aircraft to include the effect of stick location and maximum stick deflection. For instance, the F-5A stick deflection is greater than that of the A-7D by more than a factor of 2. This places the stick in a different location in the cockpit for maximum deflection.

A more recent study, AFAMRL-TR-81-39, presents a comparison between male and female strength characteristics for operating an aircraft control stick. Table XVI summarizes the percentiles for maximum forces exerted by 61 men and 61 women on an aircraft control stick during a 4 second static exertion with the right hand only. The 5th percentile values of men and women from these tests are also shown in figure 97 for comparison. It can be seen that the 95th percentile woman has approximately the same performance as the 5th percentile man. As AFAMRL-TR-81-39 observes, the force limits in this handbook may not be consistent with the capabilities of pilots.

MIL-STD-1797A
APPENDIX A

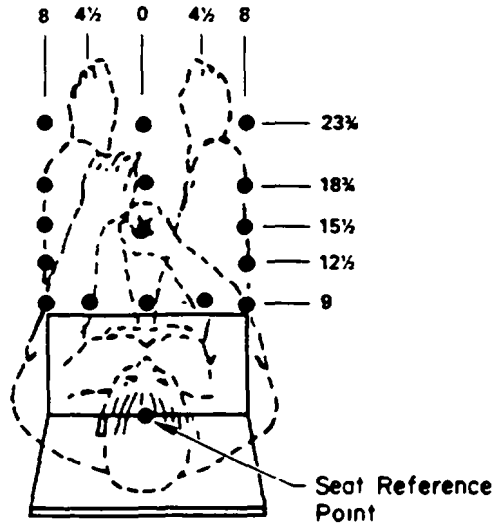

a) Physical Layout for Stick Force Tests of "Human Engineering Guide to Equipment Design" (stick 13 1/2 inches above Seat Reference Point)

◇ AFAMRL-TR-81-39, Maximum Strength Capability (5th percentile, men and women)

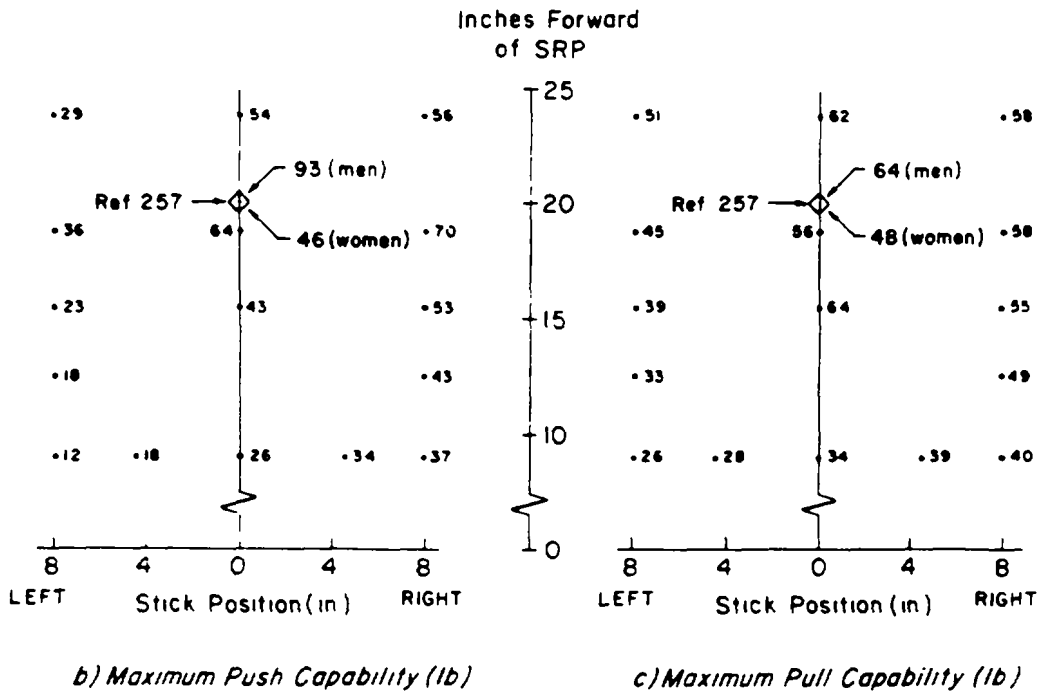
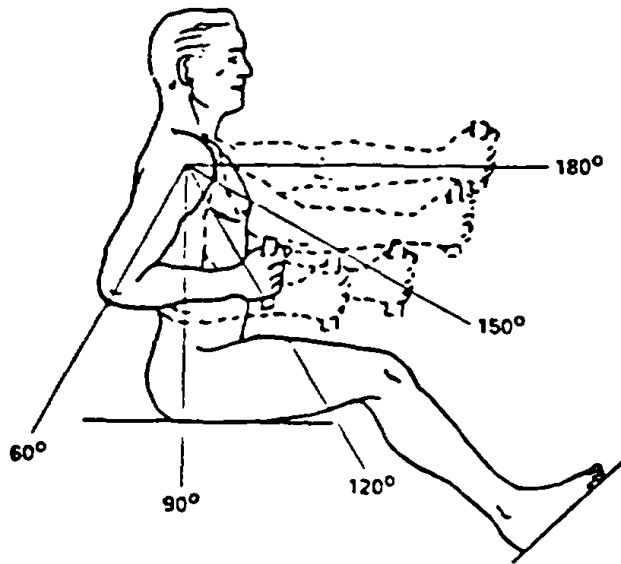
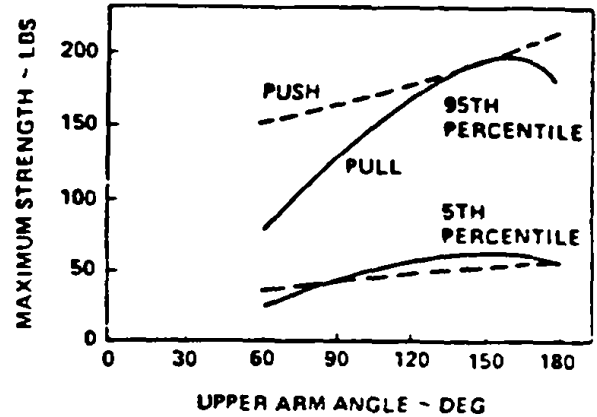

FIGURE 97. Effect of arm/stick geometry on maximum push and pull capability by the right arm for the 5th percentile male (Human Engineering Guide to Equipment Design).



a) Physical Layout



b) Upper Arm Angle vs Maximum Strength

FIGURE 98. Effect of upper arm angle on pull and push strength for the 5th and 95th percentile male (Human Engineering Guide to Equipment Design).

TABLE XVI. Maximum forces exerted on aircraft control stick (lb) by men and women (AFANIRL-TR-81-39).

CONTROL STICK DIRECTION	MEN			WOMEN		
	PERCENTILE			PERCENTILE		
	5TH	50TH	95TH	5TH	50TH	95TH
Stick Forward (Push)	93	123	165	46	87	109
Stick Back (Pull)	64	85	106	48	52	64

Figure 99 shows data from Human Engineering Guide to Equipment Design illustrating the effect of wheel angle on maximum push and pull capability for the 5th percentile male. The data are again for male Air Force personnel, using the right arm only; the wheel grips are 18 inches above the Seat Reference Point (SRP) and 15 inches apart. Figure 99a shows the various wheel angles and positions from the SRP. The greatest push and pull capability occurs at the furthest position of the wheel where the pilots' entire arm is used. This can be seen in figure 99b where the push capability at 23-1/4 inches from the SRP is approximately twice that obtained when the control wheel is at its closest at 10-3/4 inches from the SRP. Similarly the maximum pull capability varies almost by a factor of 2 in figure 99c depending on the control wheel angle and position.

MIL-STD-1797A
APPENDIX A

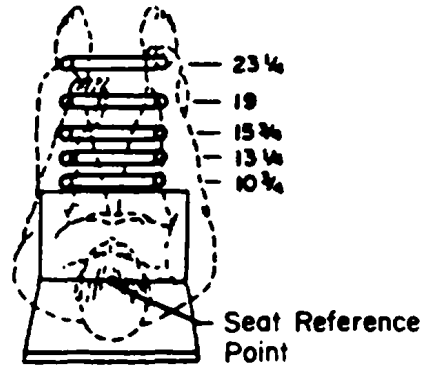

a) Physical Layout for Wheel Force Tests of "Human Engineering Guide to Equipment Design" (wheel 18 inches above seat reference point)

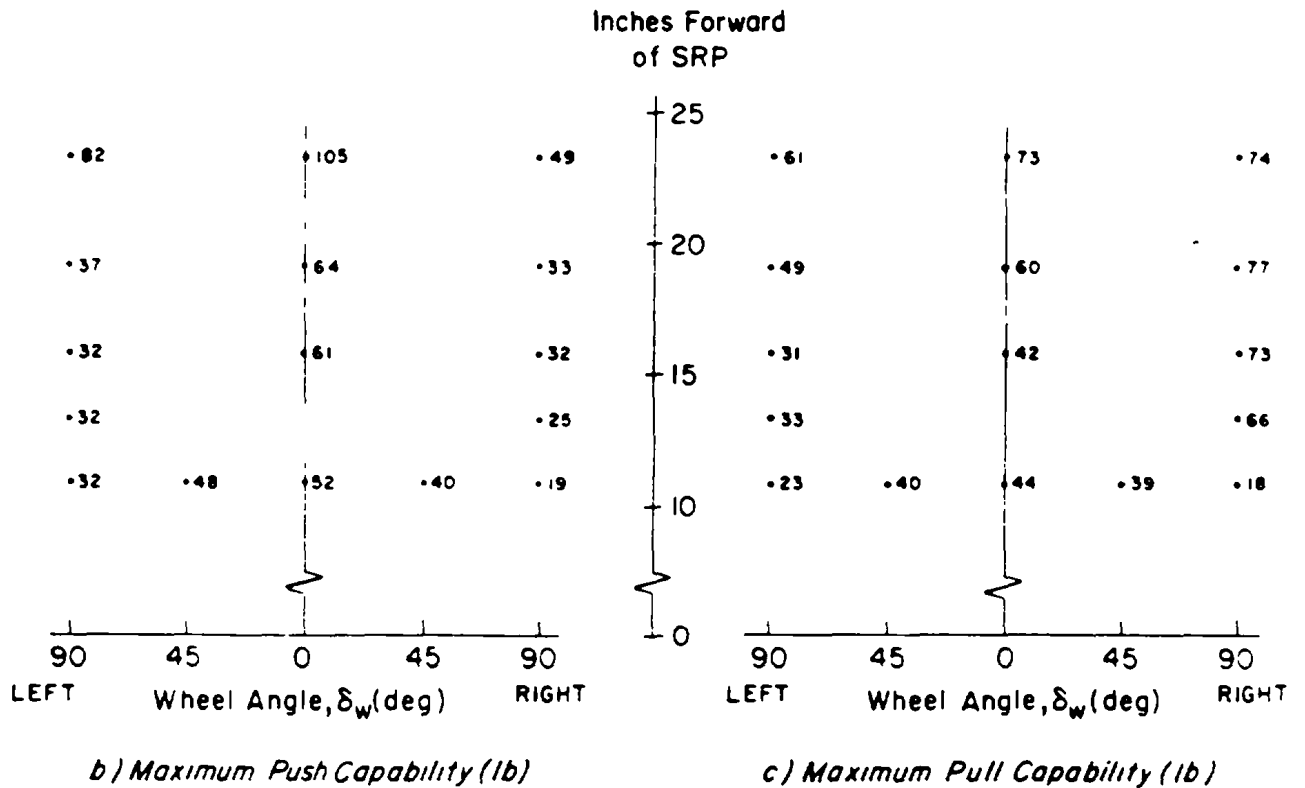

FIGURE 99. Effect of arm position and wheel angle on maximum push and pull capability by the right arm for the 5th percentile male (Human Engineering Guide to Equipment Design).

MIL-STD-1797A
APPENDIX A

It must be stressed that these are maximum forces in single applications; clearly, continuous operation (such as would be expected in meeting any of the force requirements) would produce much lower maximum forces. In a discussion of some general principles of control design, and one- vs. two-handed operations, Human Engineering Guide to Equipment Design states that:

For controls requiring single applications of force, or short periods of continuous force, a reasonable maximum resistance is half of the operator's greatest strength. For controls operated continuously, or for long periods, resistances should be much lower... Controls requiring large forces should be operated with two hands (which, for most controls, about doubles the amount of force that can be applied) depending on the control type and location and on the kind and direction of movement as follows:

When two hands are used on a stick ... located along the body midline, pull is generally almost doubled. Push is doubled near the body but is only slightly stronger at distances away from the body...

When two hands are used on stick ... controls located on either side of the body midline, at or beyond the shoulder, pull is approximately doubled, push is not greatly increased except at close distances...

Since we expect to use this standard for few aircraft with unpowered controls, little design penalty would result from lowering the maximum allowable forces. Stability and control augmentation, and response feel systems, could still keep the lightest force gradients within the presently allowable limits. Concern has been expressed, however, that with lighter maximum forces some heavy-handed pilots might be inclined to overstress the vehicle. In particular that might be the fate of trainers with new student pilots. Then, especially in a simple aircraft, a lower gradient at forward c.g. might make the gradient too low at aft c.g.

MIL-STD-1797A
APPENDIX A

4.2.8.1 Pitch axis control forces--steady-state control force per g.

These requirements apply for all local gradients throughout the range of Service load factors defined in 4.1.4.2. The term gradient does not include that portion of the force versus n curve within the breakout force.

a. In steady turning flight and in pullups and pushovers at constant speed, the incremental control force required to maintain a change in normal load factor and pitch rate shall be in the same sense (aft -- more positive, forward -- more negative) as that required to initiate the change.

b. The variations in pitch controller force with steady-state normal acceleration shall have no objectionable nonlinearities within the following load factor range: _____. Outside this range, a departure from linearity resulting in a local gradient which differs from the average gradient for the maneuver by more than 50 percent is considered excessive, except that larger increases in force gradient are permissible at load factors greater than $0.85n_L$.

c. The local force gradients shall be: _____. In addition, F_S/n should be near the Level 1 upper boundaries of these gradients for combinations of high frequency and low damping.

For all types of controllers, the control force gradients shall produce suitable flying qualities.

REQUIREMENT RATIONALE (4.2.8.1)

These requirements relate to the classical stick-free maneuvering stability (stick force per g, F_S/n) at constant speed. The basic premise is that F_S/n represents a necessary tactile cue for pilot regulation of load factor. Low values of F_S/n result in excessive sensitivity with a tendency toward exceeding the aircraft structural limits. High values lead to pilot fatigue during maneuvering.

REQUIREMENT GUIDANCE

The related MIL-F-8785C paragraphs are 3.2.2.2 and 3.2.2.2.1.

Recommended ranges for limiting departures from linearity are:

CLASS	MIN. n_z	MAX. n_z
I, II & III	0.5	Lesser of $0.5[n_o(+)+1]$ or 3
IV	0	3

The requirements for control forces in maneuvering flight, unchanged from MIL-F-8785C, are listed in table XVII.

MIL-STD-1797A
APPENDIX A

TABLE XVII. Pitch maneuvering force gradient limits.

Level	Maximum Gradient (F_s/n) _{max} , lb/g	Minimum Gradient (F_s/n) _{min} , lb/g
a. Center stick controllers		
1	$240/(n/\alpha)$ but not more than 28.0 nor less than $56/(n_L - 1)$ *	The greater of $21/(n_L - 1)$ and 3.0
2	$360/(n/\alpha)$ but not more than 42.5 nor less than $85/(n_L - 1)$ *	The greater of $18/(n_L - 1)$ and 3.0
3	56.0	The greater of $12/(n_L - 1)$ and 2.0
* For $n_L < 3$, (f_s/n) _{max} is 28.0 for Level 1, 42.5 for Level 2.		
b. Wheel controllers		
1	$500/(n/\alpha)$ but not more than 120.0 nor less than $120/(n_L - 1)$ *	The greater of $35/(n_L - 1)$ and 6.0
2	$775/(n/\alpha)$ but not more than 182.0 nor less than $182/(n_L - 1)$ *	The greater of $30/(n_L - 1)$ and 6.0
3	240.0	5.0

It was decided that the major differences in the desired maneuvering forces between fighter aircraft and transports are due to the type of controller, in addition to aircraft Class. The effects of aircraft class (really a grouping of types of missions) seem to be adequately described by limit load factor, through the $K/(n_L - 1)$ formulas of MIL-F-8785C. In addition, however, there are several arguments for having different maneuvering forces for centerstick and wheel controllers. For example, the lower limits on maneuvering forces must be higher with a wheel control because the pilot's arm is usually unsupported, whereas the pilot has very good vernier control with a centerstick even with light forces because his forearm is partially supported on his thigh. In any case, pilots seem to agree that they cannot maintain the precision of control with a wheel that they can with a stick, and that the maneuvering control forces should be higher for the wheel.

There is some evidence (ASD-TDR-63-399 and AFFDL-TR-67-51) that F_s/n at very low n/α can or should be higher than at high n/α . This is possibly due to a gradual change from concern with load factor and structural protection at high n/α to concern with control of pitch attitude alone at low n/α . Specification of

MIL-STD-1797A
APPENDIX A

forces in the form of limits on F_S/α at low n/α can be accomplished by making the F_S/n limits vary inversely with n/α : at constant speed,

$$F_S/\alpha = (F_S/n) (n/\alpha)$$

On the basis of these considerations, the upper limits on F_S/n were expressed in the form $K/(n\alpha)$ at low n/α and $K/(n_L - 1)$ at high n/α , with separate requirements for stick and wheel controllers. On the basis of long experience with unpowered-control airplanes, which tend to have $F_S/$ invariant with airspeed, the lower boundaries do not vary with n/α .

However, there is some question as to the significance of the ASD-TDR-63-399 and AFFDL-TR-67-51 tests. These references are discussed in detail under Supporting Data.

To illustrate the use of the gradient limits of table XVII, figures 100 and 101 show possible boundaries for two representative aircraft. Figure 100 is for a centerstick controller with $n_L = 7.0$; figure 101 is for a wheel controller with $n_L = 3.0$. Similar plots may be constructed for any aircraft using the table XVII formulas. However, such plots, while representing the table XVII suggested limits, do not convey the entire picture, as illustrated by the following considerations.

Effects of stick/wheel position on acceptability of F_S/n are not covered by these requirements. But with the variation in force capability shown in the discussion of 4.2.8 it seems intuitively obvious that there must be an interrelationship of force and deflection gradients with controller location.

Another item for consideration is the allowance in table XVII for considerably higher values of F_S/n when n/α is low. For example, figure 102 (from AFFDL-TR-78-171) illustrates the variation of F_S/n with airspeed for the OV-10A aircraft, due to an elevator spring tab. The apparently large and rapid change in F_S/n actually results in fairly constant maximum stick force at stall (figure 103) or n_L , whichever comes first. Perhaps that becomes the important factor at speeds below maneuvering speed (V_A , see figure 102).

MIL-STD-1797A
APPENDIX A

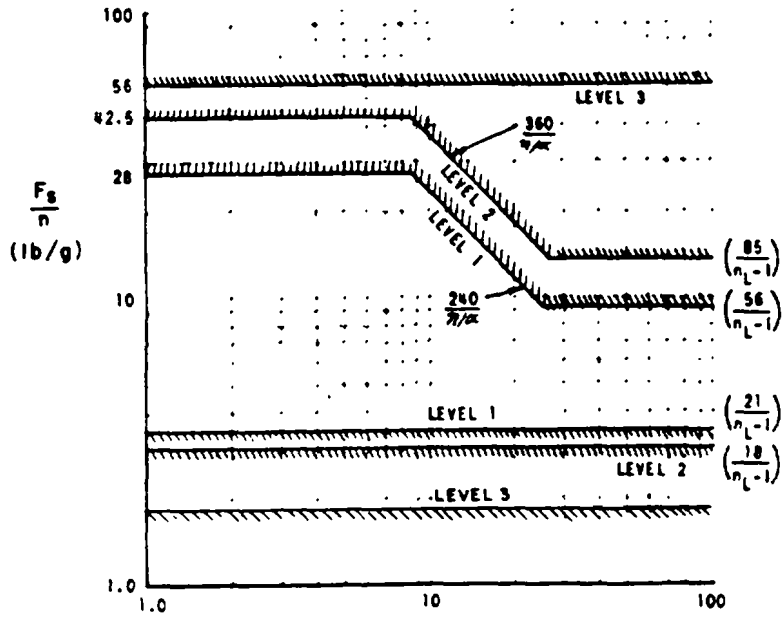

FIGURE 100. Elevator maneuvering force gradient limits: center-stick controller, $n_L = 7.0$.

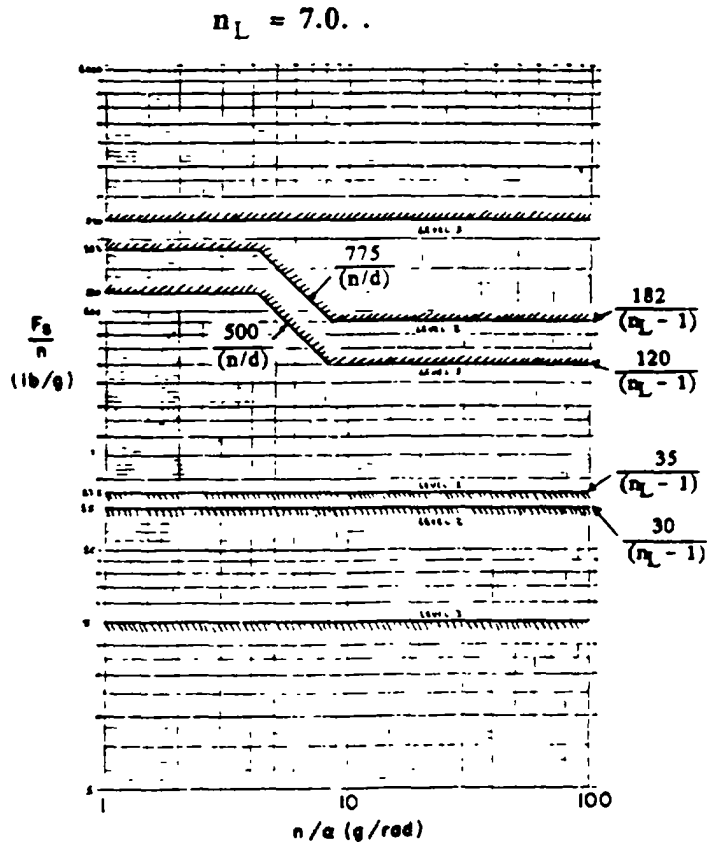

FIGURE 101. Elevator maneuvering force gradient limits: wheel controller, $n_L = 3.0$.

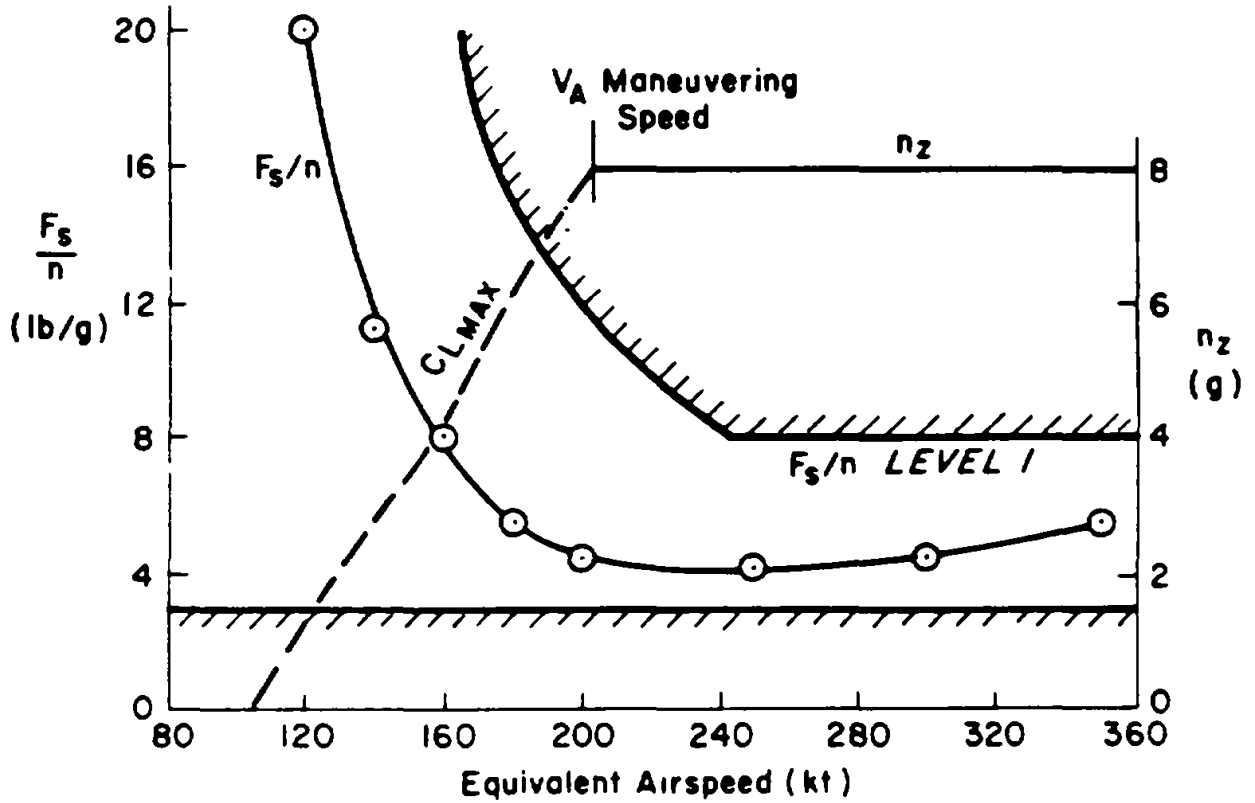

FIGURE 102. OV-10A maneuvering control (AFFDL-TR-78-171).

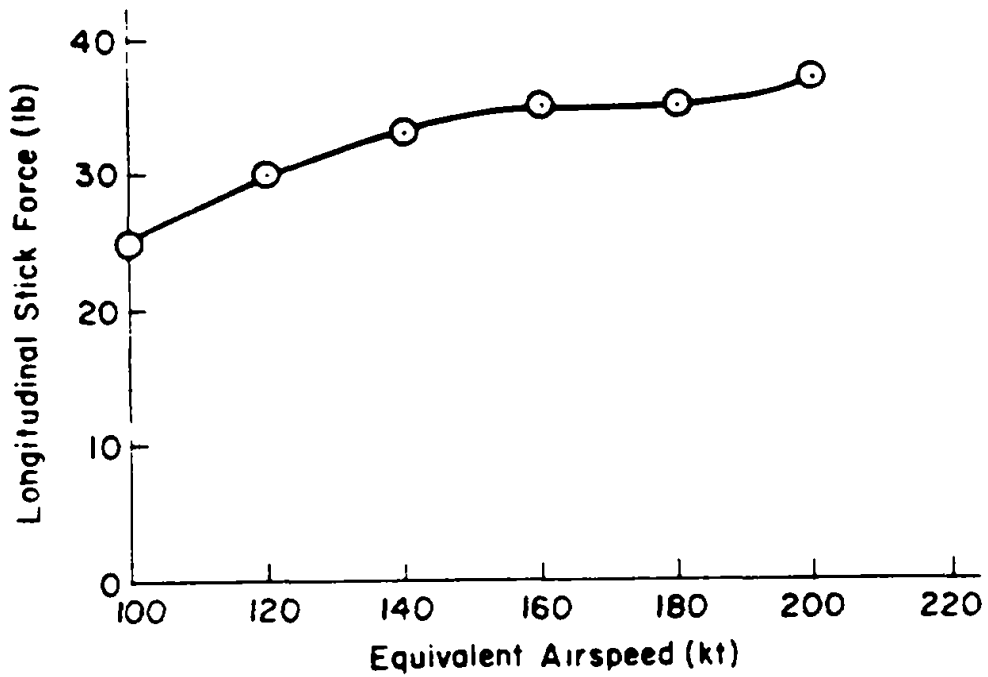

FIGURE 103. Longitudinal stick force at stall (AFFDL-TR-78-171).

MIL-STD-1797A
APPENDIX A

A more basic consideration relative to table XVII is the complete absence of a force gradient specification for sidestick controllers, reflecting in part the limited data base. However, AFFDL-TR-79-3126 and Class

MIL-STD-1797A
APPENDIX A

79A Final Report of AF Test Pilot School, based on a series of flight tests conducted by students of the USAF Test Pilot School, give some insight into preferred gradients. These data, figure 104, are for an air-to-air tracking task. The test aircraft was the USAF/Calspan variable stability T-33, with a T-38A utilized as the target. The ratings shown are the average over three pilots, all with fighter experience. An approximate Level 1 boundary is suggested in figure 104. In general, the F_S/n range is comparable to that of table XVII, i.e., 2-14 lb/g. The relatively weak frequency dependence may also exist for centerstick controllers, although there are no data to support this. More data from these evaluations are given in Requirement Guidance for 4.2.8.4.

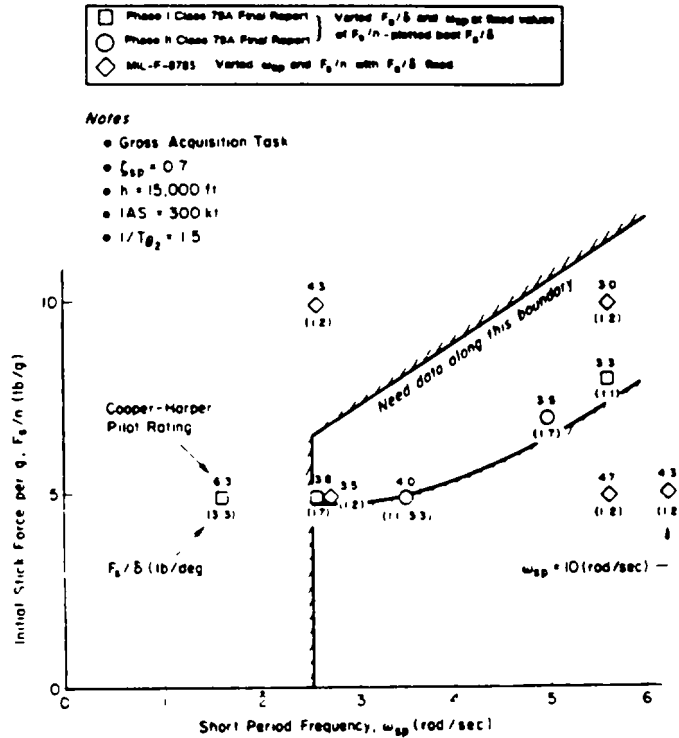

FIGURE 104. Short-period frequency vs longitudinal stick force per g (F_S/δ separately optimized) for a side-stick controller.

The F_S/n gradients in figure 104 are the initial values; as mechanized, the slope at larger deflections was half the initial slope. The breakout forces were 1/2 lb. AFFDL-TR-79-3126 suggests that the sidestick neutral position

... be oriented so that in wings-level unaccelerated flight the pilot need never move his wrist further aft than 5-7° forward of vertical to command maximum permissible load factor...

Available data would tend to support a neutral position of 10° to 17° forward of vertical and 8° to 12° left (inboard) of vertical.... A pilot adjustable armrest is absolutely mandatory, and its design can influence pilot acceptability as much as any other parameter.

SUPPORTING DATA

The data base for control force requirements is sparse, and limited entirely to Class IV aircraft. The most thorough data sets are from USAF/Calspan T-33 flight tests in which pilots chose optimum values of F_S/n

MIL-STD-1797A
APPENDIX A

for varying short-period characteristics. However, the useful information is basically a byproduct, since the intent of these tests was the study of short-period frequency and damping. So, while specific conditions can be found for which ζ_{sp} and ω_{sp} fell within Level 1 boundaries, they were not held constant, and subsequent pilot ratings could reflect an interrelationship of ζ_{sp} , ω_{sp} , and F_S/n . In addition, breakout is not documented in any of the supporting references except in AFFDL-TR-70-74 (where it is reported to be zero).

AFFDL-TR-66-163 and FDL-TDR-64-60 contain data used in AFFDL-TR-69-72 to support the F_S/n limits of MIL-F-8785B. More recent tests (AFFDL-TR-79-122 and AFFDL-TR-70-74) add to the data base for centerstick controllers. AFFDL-TR-68-91 provides some insight into requirements for wheel-type controllers.

Figure 105 compares values of optimum F_S/n from AFFDL-TR-66-163 with the requirements of table XVII. In this test program gradients were selected before performing evaluation tasks, and were held constant throughout each evaluation. The external parameters (ζ_{sp} , ω_{sp} , $1/T_{\theta_2}$, τ_e) are all within Level 1 limits but may vary widely. While there is considerable scatter, pilot ratings degrade as F_S/n increases. However, a much lower $(F_S/n)_{max}$ (≈ 6.5 lb/g for Level 1) than the specification upper limit is indicated

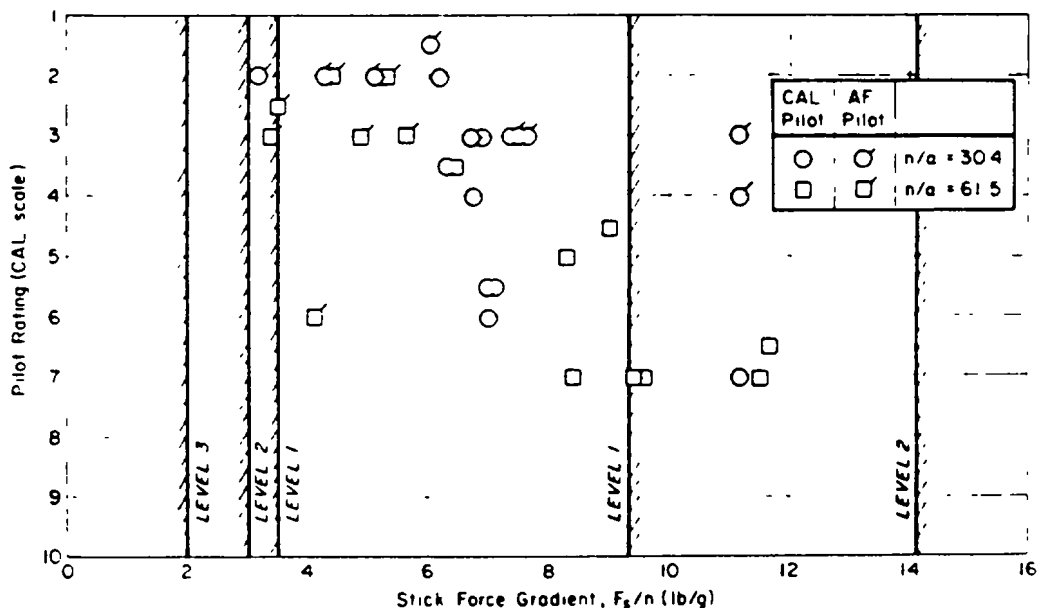

FIGURE 105. Comparison of optimum F_S/n with limits of table XVII (AFFDL-TR-66-163, Category A; $n_L = 7$ g).

Data from FDL-TDR-64-60 (for front-side and bottom operations only) are shown in figure 106. A much higher range of F_S/n was chosen for these (Category C) tests – again, by the pilots at the start of each evaluation. These data were used as support for the adoption of n/α -dependence on $(F_S/n)_{max}$ in AFFDL-TR-69-72. However, the goal of the experiments was to investigate short-period dynamics and not F_S/n influences, so there is no single constant in the data. In addition, the task consisted of an instrument landing approach until 2 miles from the runway; visual approach to the threshold; and wave-off at 25-100 ft. There is evidence (e.g., AFFDL-TR-78-122) that requiring a full approach through landing (wheels on runway) can produce quite different results than with a waveoff and go-around. This may be the reason that, of the 18 data points on figure 106, only three have PR > 4 -- generally less scatter than one might expect. (This will become clear when the AFFDL-TR-78-122 data are introduced.)

MIL-STD-1797A
APPENDIX A

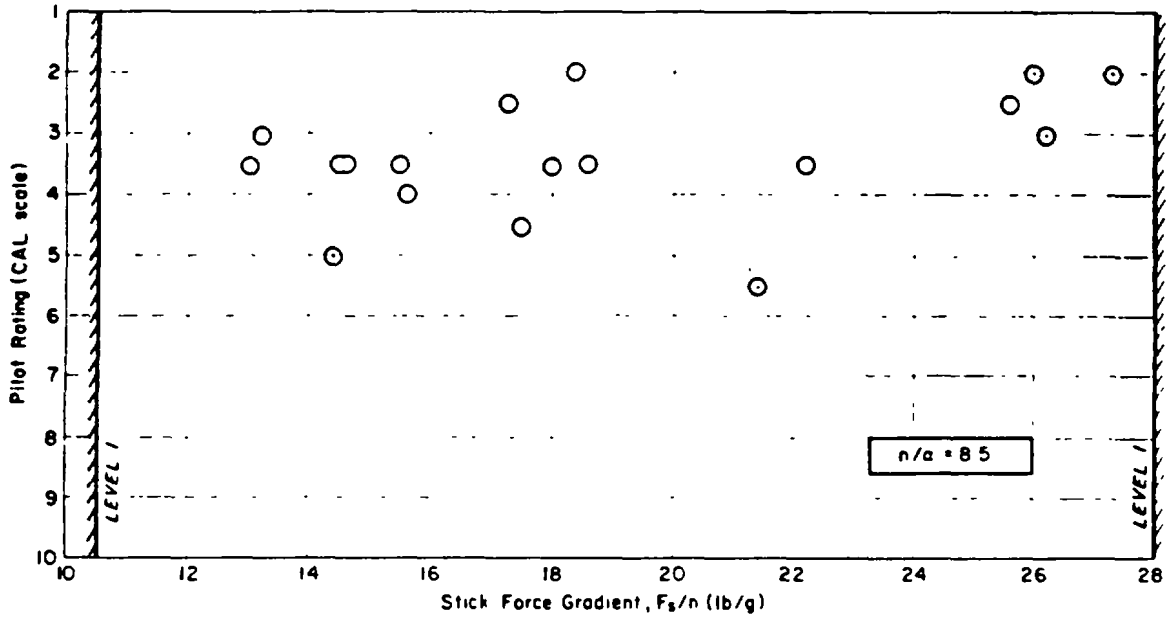

FIGURE 106. Comparison of optimum F_s/n with limits of table XVII (FDL-TDR-64-60, Category C; $n_L = 3$ g).

The object of the flight test program of AFFDL-TR-70-74 also was an analysis of effects of short-period variations (in this case, through addition of higher-order lead/lag networks). Again, choice of optimum F_s/n was up to the pilots, and was specified before the rest of the evaluation task was performed. The data of figure 107 are for only those configurations where ζ_e , ω_e , $1/T_e$ and τ_e are Level 1, based upon equivalent system matches and requirements. The data support the lower limits, but again suggest a smaller upper limit. Generally, the pilot ratings are Level 2 for $F_s/n > 6$ lb/g.

The LAHOS program of AFFDL-TR-78-122 consisted of the most stringent set of tasks flown. Pilots were required to: a) fly an instrument approach to within 200 ft of the runway, followed by a visual landing; b) fly two visual landings with an intentional offset on close final; and c) land precisely at a marked location on the runway. These are clearly tight tasks requiring aggressive control actions by the evaluation pilots. A key difference between the AFFDL-TR-78-122 program and that of FDL-TDR-64-60 was pilot selection of F_s/n ; initial selection was made at the start of a run, but the gradient could be changed at any time during the run at the pilot's request. The range of F_s/n chosen by the pilots (figure 108) is similar to that of figure 106. As before, only those data for which ζ_e , ω_e , $1/T_e$ and τ_e are Level 1 are shown.

MIL-STD-1797A
APPENDIX A

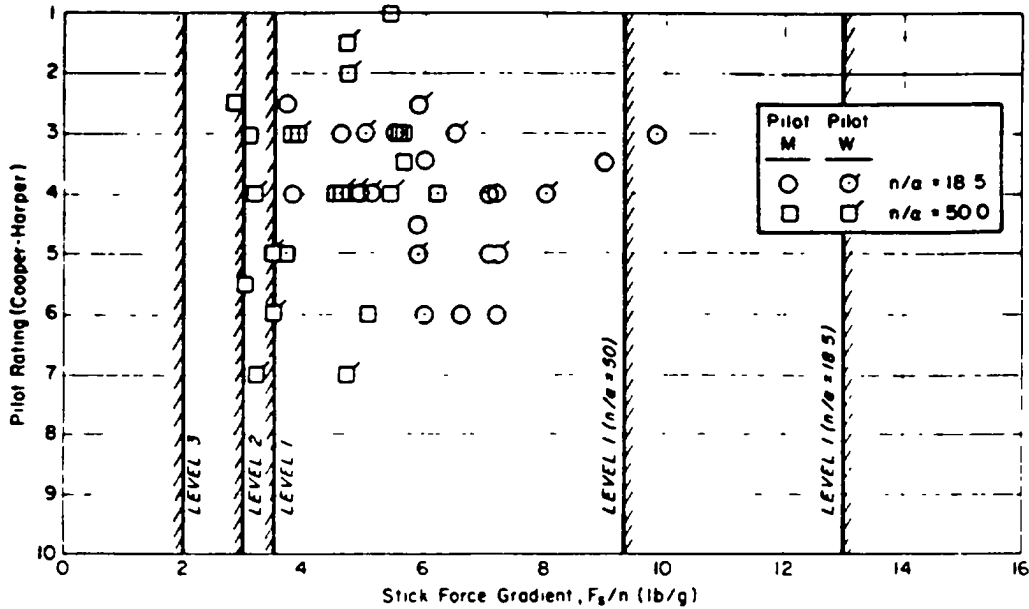

FIGURE 107. Comparison of optimum F_S/n from data of Neal and Smith (AFFDL-TR-70-74) with limits of table XVII (Category A; $n_L = 7$ g).

The pilot rating data of figures 105, 106, 107, and 108 are compiled on figure 109. (For clarity, the ratings, have been averaged over 1 lb/g slices of F_S/n , to reduce the number of points shown. Standard deviations are also indicated.) Very few optimum gradients less than 3 lb/g were chosen. The gradients chosen by the pilots tend to coalesce around 3-7 lb/g -- except those for AFFDL-TR-78-122 and FDL-TDR-64-60, which are for Category C operations. As has been noted, the real issue at very low n/α may not be F_S/n , but $(F_S)_{max}$ at stall.

At this point the only conclusion to be drawn from figure 109 is that there is a definite preference for low stick force gradients, between about 3 and 4 lb/g in Class IV aircraft. In addition, the overall range of selected gradients is small (except as noted above for AFFDL-TR-78-122 and FDL-TDR-64-60), up to 12 lb/g. This of course could be a function of other factors, such as short-period frequency and damping or stick displacement or location.

The wheel-controller data, from AFFDL-TR-68-91, are shown on figure 110. Both fixed and pilot-selected gradients were tested on the USAF/Calspan T-33, but there appear to be no rating differences. While the data are sparse, they indicate mild support for the table XVII upper limit for Level 1. Within the Level 1 limits, 20 points out of 27 are rated 3-1/2 or better; outside the upper limit, 5 out of 6 have ratings greater than 3-1/2.

Two other data sources, ASD-TDR-63-399 and AFFDL-TR-67-51, were studied briefly for any additional information on an n/α -dependence. ASD-TDR-63-399 is a fixed-base simulator study utilizing a sidestick (modeled after the X-15 sidestick) with nonlinear deflection characteristics. The tasks generally were low-demand (including pilot-initiated disturbances) or required flying through rough air. It is felt that pilot preference in a ground-base simulator may not reflect the real-world situation where the pilot feels the full normal acceleration:

MIL-STD-1797A
APPENDIX A

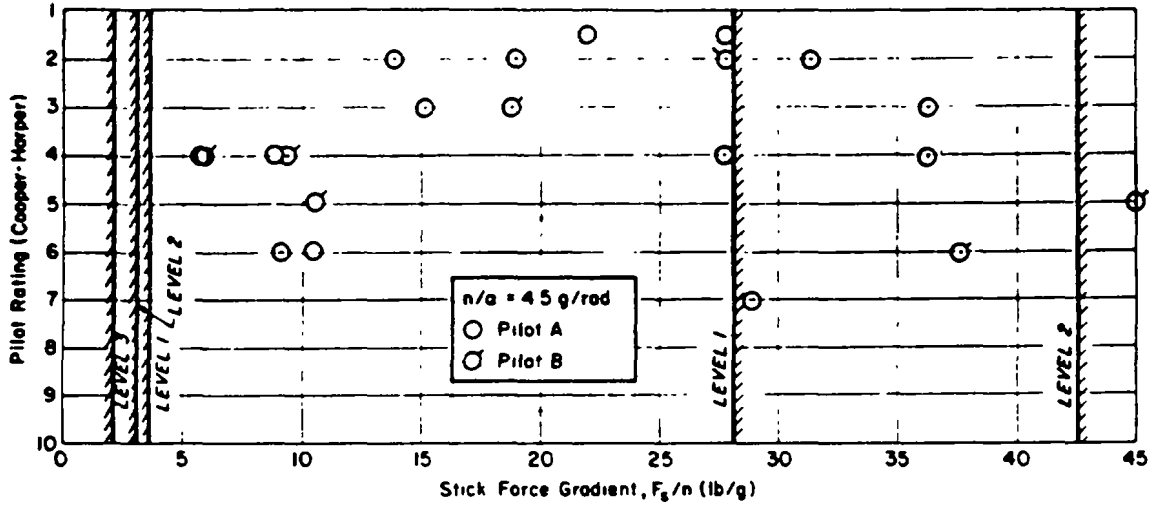

FIGURE 108. Comparison of optimum F_s/n from LAHOS (AFFDL-TR-78-122) data with limits of table XIV (Category C; $n_L = 7$ g).

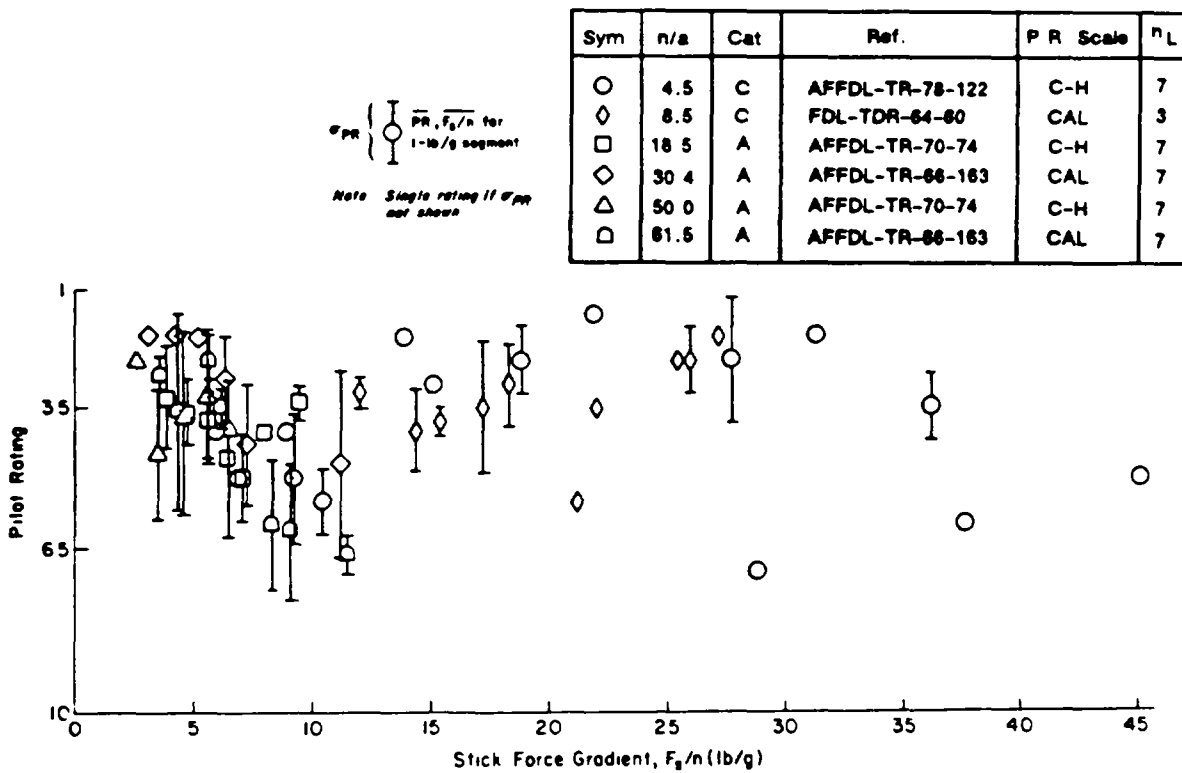

FIGURE 109. Average pilot ratings for 1-lb/g segments of F_s/n .

MIL-STD-1797A
APPENDIX A

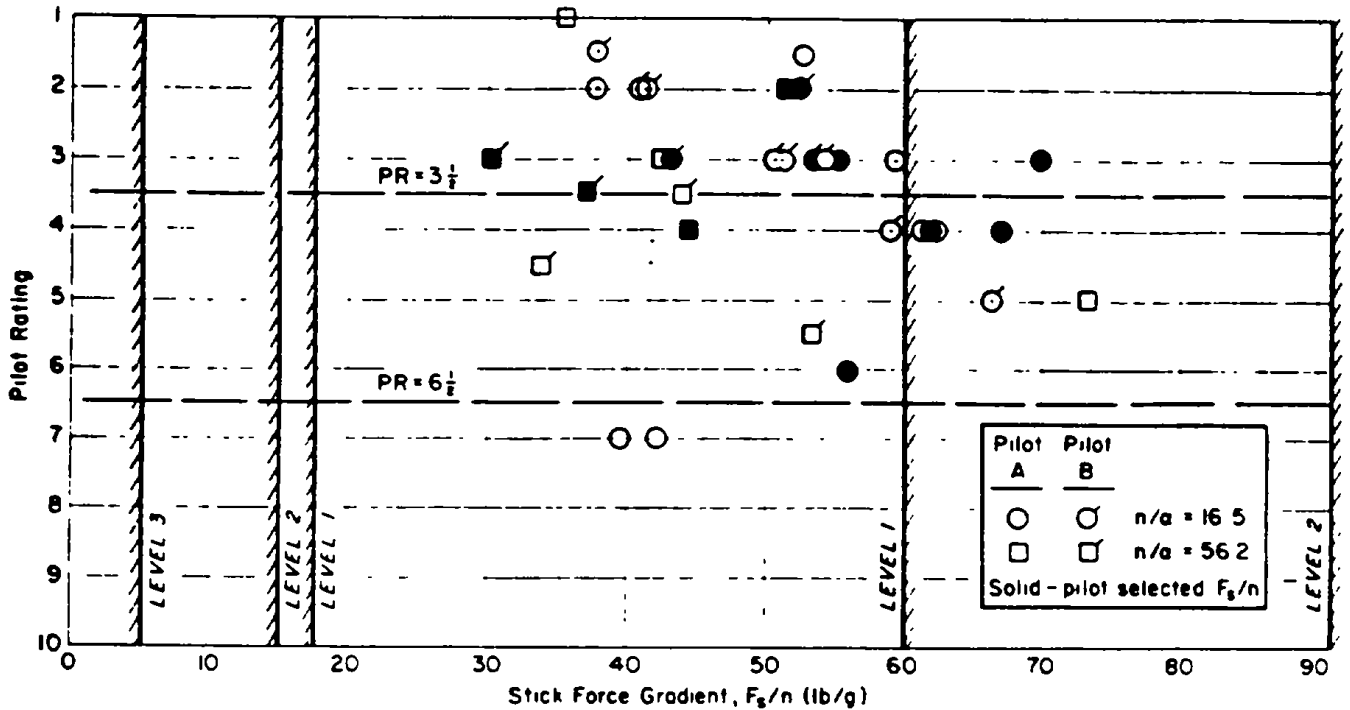

FIGURE 110. Comparison of F_s/n with limits of table XVII, wheel controllers (AFFDL-TR-68-91, Category A; $n_L = 3$ g).

AFFDL-TR-67-51 involved early simulation of the C-5A design with a B-26 in-flight simulator. Column travel (approximately 20 inches per g) was considered by the three evaluation pilots to be excessive. As a result, pilot ratings for both the unaugmented and augmented vehicle were poor, as summarized in the following conclusion:

On the basis of the three-pilot sample as a whole, there is little conclusive evidence as to the relative desirability of the two stick forces per g evaluated...Pilot A most clearly indicated the desirability of the higher value (158 lb/g), particularly in the unaugmented case. Pilot B felt that this value was a bit high, but acceptable; Pilot C preferred the low value of 106 lb/g.

The bottom line of this discussion is: the supportive data necessary to fully validate a set of requirements for F_s/n do not seem to exist. It is felt that the requirements of table XVII, which are unchanged from MIL-F-8785C and little changed from MIL-F-8785B, will serve as a preliminary guide for controller design since nothing better is available. Ultimately a set of criteria might be devised in which displacements, gradients, and locations of the controllers are all interdependent -- as they must be in real life.

REQUIREMENT LESSONS LEARNED

Much of the available information on existing vehicles suggests that the lower limits of F_s/n for wheel controllers may be too high. For example, figure 111 (from AFFDL-TR-78-171) summarizes elevator control force gradient characteristics of three large cargo or transport airplanes, for Category B at forward and aft center of gravity conditions. According to this summary the L-1011 complies with the maximum and minimum control force gradient requirements. The C-5A at forward c.g., pitch dampers off, compares favorably with the Level 1 maximum values; however, some gradients at aft c.g. fall below the Level 1 and Level 2 boundaries (only the SAS off data were presented for comparison). The C-141A/YC-141 B data

MIL-STD-1797A
APPENDIX A

slightly exceed the Level 1 maximum limit at forward c.g. Pilot comments for the C-141A/YC-141B support the maximum boundary. According to Silvers and Withers (AFFDL-TR-75-3) "The C-5A control force gradients are rated satisfactory and acceptable", so the minimum boundary for Level 1 requirements appears to be too high in this instance.

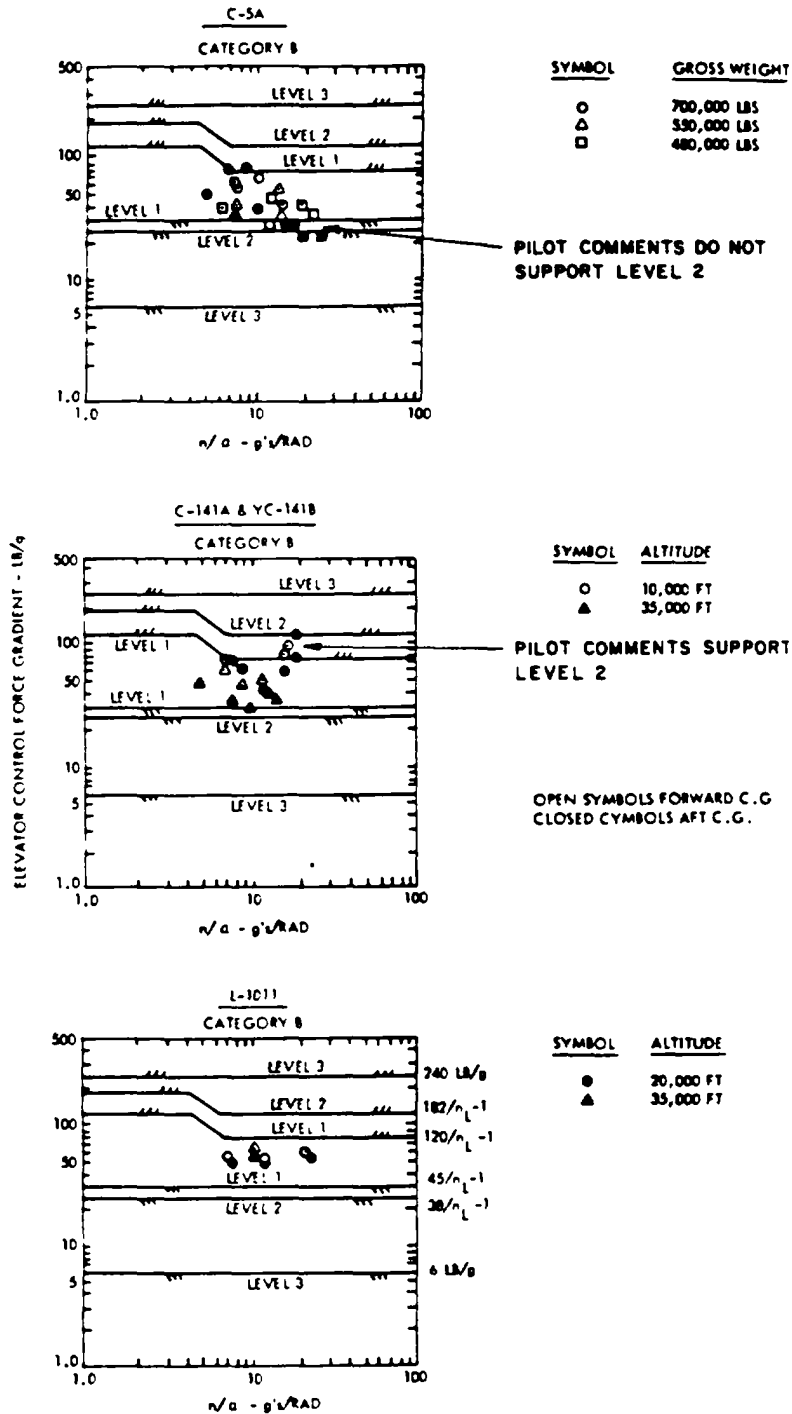

FIGURE 111. Elevator control force gradients for transport aircraft (from AFFDL-TR-78-171).

MIL-STD-1797A
APPENDIX A

Results from simulation and flight tests of different stick force gradients on the B-1 bomber (AFFDL-TR-78-171) are summarized below:

Consolidated pilot comments - based on flight simulator tests

- 21 lb/g Level 1 minimum is too high for 2 g aircraft.
- 7-8 lb/g Level 1 minimum is good design guide for 3 g aircraft.
- 3 lb/g minimum should be maintained for failure modes

B-1 terrain following flight pilot comments

- 17 lb/g too high based on fatigue:
 - Meets n_L 3 requirements
 - Below n_L 2 requirements
- Over rugged terrain - 10 minutes is tiring
- Composite terrain - 2 pilots sharing task
 - Short task - 30 minutes
 - Medium task - 1 hour
 - Long task - 2 hours

The pertinent findings were: 1) that a minimum F_S/n of 7-8 lb/g for Level 1 was acceptable for an aircraft with $n_L = 3$ g [where, by table XVII $(F_S/n)_{\max} = 10.5$ lb/g]; and 2) that F_S/n as low as 17 lb/g was too high for terrain-following flight, based upon pilot fatigue. The conclusions suggest that acceptable values of F_S/n are task-dependent (or time-dependent), though a relaxed lower limit alone might suffice. The acceptability of both minimum and maximum values of F_S/n may be directly related to workload: e.g., high gradients may be undesirable if the pilot is required by the task to divert his attention or to track tightly in the presence of atmospheric disturbances. Low gradients in an emergency situation may lead to overcontrol.

Especially for fighter aircraft, nonlinear gearing and force gradients are commonly used to get a gradient good for fine tracking without a fatiguing force level for gross maneuvering. Carried too far, however, these nonlinearities can promote pitch-up like an aerodynamic pitch-up. The F-15 design, which barely meets the specified linearity requirement, has been well accepted.

A pitch rate command/attitude hold system, compensated for bank angle, (AFWAL-TR-81-3118) seems well accepted for approach and landing of large aircraft. The initial gradient can meet this specification, but an integrator zeros the control force in steady turns (a "g" limiter was incorporated).

Many Class I (general aviation) aircraft tend to fall around and below the minimum F_S/n requirements. Figure 112 compares various aircraft in landing configurations (gear and flaps extended) with the wheel-controller requirements of table XVII. The data were obtained from NASA-TN-D-3726 and FAA-RD-77-25. F_S/n limits are drawn for $n_L = 3.8$ (Federal Aviation Regulations requirements for Normal category operations) and $n_L = 2.0$ (the limit specified for most of the aircraft in landing configuration). With the single exception of the Cessna 177, none of the aircraft of figure 112 at aft c.g. meet the $(F_S/n)_{\min}$ requirement for $n_L = 2.0$ [The Citabria is an aerobatics category (6g) stick-controlled design.] The seven-

MIL-STD-1797A
APPENDIX A

aircraft study of NASA-TN-D-3726 resulted in a range of $19 < F_S/n < 45$ lb/g for acceptable gradients for Normal category operations (see figure 112). No information is available on what was considered unsatisfactory, though 5 lb/g was considered to be too light; these low gradients allowed the limit load factor to be attained too easily.

During F-14A flight tests, a reduced stick force gradient was noticed at load factors greater than 4g. In simulated defensive break turns and rolling pullouts, using full lateral stick and rapid aft stick inputs lead to an overshoot of target load factor severe enough to increase the likelihood of exceeding established limits in aggressive transonic maneuvering. This is a deficiency which should be avoided in future designs, according to the Naval Air Test Center.

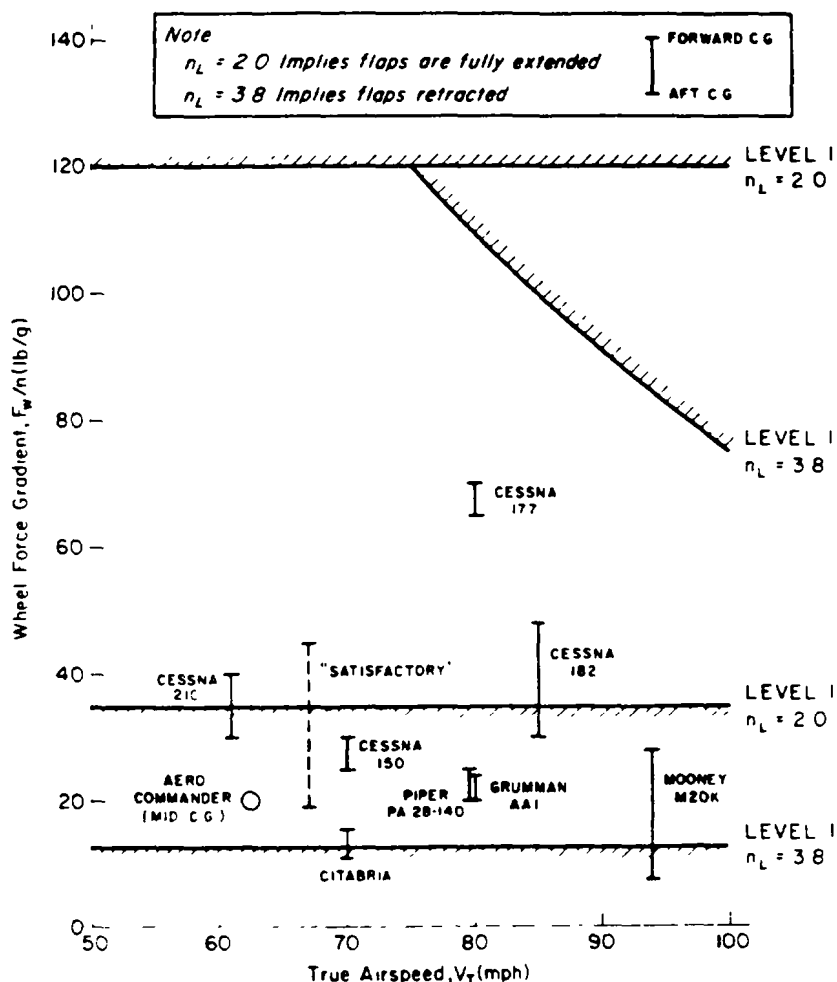

FIGURE 112. Comparison of F_S/n for various Class I airplanes in landing approach (Category C) with limits of table XVII.

5.2.8.1 Pitch axis control forces--steady-state control force per g-verification.

Verification shall be by analysis, simulation and flight test

VERIFICATION RATIONALE (5.2.8.1)

The following discussion is concerned with the flight testing aspects of determining control force characteristics. At the discretion of the procuring activity, a valid moving-base piloted simulation may be used in proof-of-concept stages to assess the suitability of force and gearing nonlinearities.

MIL-STD-1797A
APPENDIX A

There are several methods for obtaining the required control force data. The best method to use depends primarily on the speed range under consideration. A major factor in determining the appropriate method for a given speed range is that load-factor control gradients are defined for constant speed. The method selected must therefore result in zero or small speed changes with n , or at least include a means for eliminating the effects of any speed changes. At speeds where characteristics vary significantly with Mach number, speed should be interpreted as Mach number since that is the primary pilot reference.

One method is to use a series of alternating symmetric pullups and pushovers, sequenced so as to minimize the airspeed and altitude changes. The control is held fixed after each input until the short-term motion becomes steady state, and measurements are taken at a near-level attitude.

Another method is to perform a series of stabilized turns after trimming the aircraft in level flight. The load factor can be changed by changing the bank angle, and the airspeed held constant by using a different rate of descent for each load factor. The throttle and trim controller should be left at their trim settings throughout the maneuver to minimize the possibility of introducing extraneous pitching moments. The gradients obtained in this manner will not be quite as linear as with the symmetric pullup method because of the difference in pitch rate between pullups and turns (see, e.g., Airplane Performance Stability and Control). But, with the possible exception of a more stable slope near 1 g in the turns, the differences are generally small and can easily be accounted for, if necessary, knowing pitch rate. Of course load factors between ± 1 g cannot be obtained in near-level turns. A progressively tightened turn of this sort, at constant airspeed, is a wind-up turn, Navy style (USNTPS-FTM-103).

A third method that is sometimes used is a windup turn, Air Force style (FTC-TIH-79-2). After trimming in level flight, a turn of a certain number of g's is initiated, and the speed is allowed to decrease slowly as the g-level and altitude are held constant. The test is then repeated at several other g-levels until the complete range is covered. In this way, control gradient data can be obtained rapidly for several speeds. Again, the trimmer and throttle should be left at the trim settings and the rate of change of airspeed controlled by changing the rate of descent. The major disadvantage of this method is that it is less accurate because more careful pilot technique is required.

In general, the symmetric pullup method will work well at high speeds, but the airspeed changes will be excessive if the method is used at low speeds. On the other hand, the turn methods work well at low speeds, but can cause excessive altitude changes at high speeds.

VERIFICATION GUIDANCE

An expression for the control deflection required is given under 4.2.7.2. Neglecting any effects of $C_{h\alpha}$, mass imbalance, bobweight, etc., the control force per g in pullups is

$$\frac{dF_S}{dn} = -\frac{dF_S}{d\delta_S} \cdot \frac{C_{L1}}{C_{m\delta_S}} \left(\frac{C_{m\alpha}/C_{n\alpha} + C_{mq} \cdot g\bar{c}/(2V^2 C_{L1})}{1 - (C_{L\delta}/C_{m\delta})(C_{m\alpha}/C_{L\alpha})} \right)$$

MIL-STD-1797A
APPENDIX A

For a reversible control system, consideration of $C_{h\alpha}$, gives

$$\frac{dF_s}{dn} = \frac{-\frac{d\delta_e}{d\delta_s} \cdot \bar{q}_e S_e \bar{c}_e}{1 - \frac{C_{L\delta_e}}{C_{m\delta_e}} \cdot \frac{C_{L\alpha}}{C_{m\alpha}}} \left[\frac{C_{h\alpha}}{C_{L\alpha}} \left(C_{L1} + \frac{g\bar{c}}{2V^2} \cdot \frac{C_{L\delta_e}}{C_{m\delta_e}} C_{mq} \right) - \frac{C_{h\delta_e}}{C_{m\delta_e}} \left(C_{L1} \frac{C_{m\alpha}}{C_{L\alpha}} + \frac{g\bar{c}}{2V^2} C_{mq} \right) \right]$$

where $C_{L1} = W/(\bar{q} S)$; F_s and δ_s are force and linear deflection of the control stick, positive aft; and sub e denotes elevator parameters.

VERIFICATION LESSONS LEARNED

For the X-29, constant-altitude (± 2000 ft) wind-up turns worked well.

MIL-STD-1797A
APPENDIX A

4.2.8.2 Pitch axis control forces--transient control force per g.

The buildup of control forces during maneuver entry must not lag the buildup of normal acceleration at the pilot's location. In addition, the frequency response of normal acceleration at the pilot station to pitch control force input shall have the following characteristics: _____.

REQUIREMENT RATIONALE(4.2.8.2)

This requirement accounts for the possibility that stick force per g for high-frequency inputs may be reduced considerably below the steady-state limits set in 4.2.8.1. Such reduced values of F_S/n may lead to pilot-induced oscillations. This requirement is intended to help prevent such an occurrence.

REQUIREMENT GUIDANCE

The related MIL-F-8785C paragraphs are 3.2.2.3.1 and 3.2.2.3.2.

The following values are recommended:

MINIMUM F_S/n AT ANY FREQUENCY GREATER THAN 1 RAD/SEC (Units are lb/g)			
	Level 1	Level 2	Level 3
Center-stick controllers	$\frac{14}{n_L - 1}$	$\frac{12}{n_L - 1}$	$\frac{8}{n_L - 1}$
Wheel controllers	$\frac{30}{n_L - 1}$	$\frac{25}{n_L - 1}$	3.3
Side-stick controllers	The minimum F_S/n shall not be objectionable to the pilot		

Lacking any other data, we suggest using the center-stick values for one-handed controllers and the wheel controller values for two-handed controllers of other types.

Bobweights tend to alter the phasing between the pilot's force inputs to the stick and the resulting stick motion. For an aircraft which obtains all of its F_S/n (steady-state) from a bobweight, for instance, the stick can be moved with essentially zero force to initiate a rapid pull-up. As the n response develops, the bobweight then tries to pull the stick back to neutral, thus requiring that the pilot add increasing forces to hold the control input. This means that the stick position leads the control force by a considerable amount at moderately high frequencies. Also, if the damping of the control system itself is low, the pilot will feel the stick constantly slapping against his hand during rapid maneuvering. Requirements have thus been set on controls-free damping in terms of dynamic F_S/n and feel system phasing.

The requirements concerning ζ_{sp} , ω_{sp} , and F_S/n will normally be sufficient to insure adequate maneuvering characteristics. In certain situations, however, these requirements alone will not insure against pilot-induced oscillations. Consider, for example, an aircraft that meets the Level 2 requirements on ζ_{sp} , ω_{sp} , and F_S/n for Category A Flight Phases. If both ζ_{sp} and F_S/n are near the lower limits, the aircraft can have pilot-induced oscillation (PIO) tendencies serious enough to make it unacceptable. The requirements listed above are designed to prevent this situation, by setting an upper limit on frequency-response amplitude of $n(s)/F_S(s)$ [expressed as a lower limit of $F_S(s)/n(s)$]. This has the effect of increasing the minimum F_S/n requirements of 4.2.8.1 for low values of ζ_{sp} (stick-free), as can be seen

MIL-STD-1797A
APPENDIX A

by examination of figure 113. The dip in amplitude corresponds to the short-period resonance; and the size of the dip, expressed as the ratio $(F_S/n)/(F_S/n)_{\min}$ is a unique function of ζ_{sp} (stick-free) (assuming that the control-system natural frequency is appreciably higher than ω_{sp} and that the pilot location is not extreme), figure 114. It can be seen that F_S/n must increase rapidly with decreasing values of stick-free ζ_{sp} in order to maintain a given value of $(F_S/n)_{\min}$.

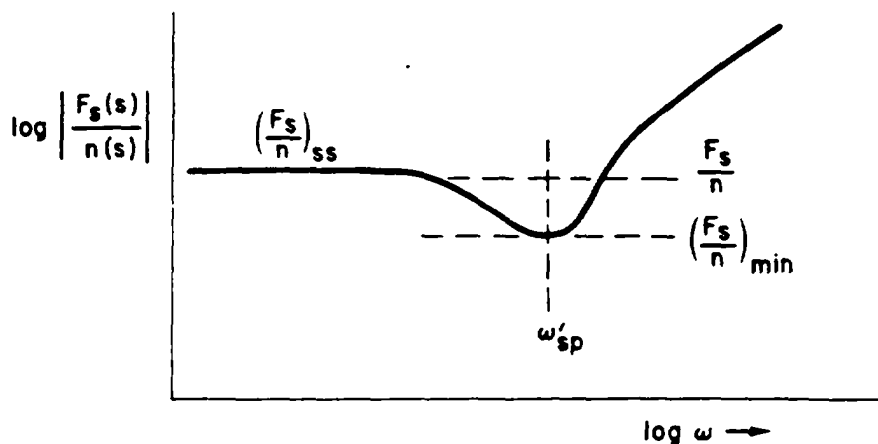

FIGURE 113. Illustration of resonance dip in F_S/n due to low ζ_{sp} .

It should be understood that if the control system natural frequency is not appreciably higher than ω_{sp} (stick-free), the frequency response $F_S(s)/n(s)$ will not be entirely second-order in the region of $(F_S/n)_{\min}$. If the control system damping is not very high, as is often the case, the resonance dip can be accentuated by the control system mode, as can be seen from figure 115. In this situation, an equivalent ζ_{sp} (stick-free) can be obtained from figure 114 by measurement of $(F_S/n)/(F_S/n)_{\min}$. That value may not be the same as obtained by fitting a lower-order system to the actual frequency response. For this requirement the actual $(F_S/n)_{\min}$ should be used. The effect of cockpit distance from the instantaneous center of rotation for control inputs, and of structural modes, will usually, though not necessarily, be negligible.

The requirements stated above are intended to inhibit development of longitudinal PIOs. However, to the extent that $(F_S/n)_{\min}$ is defined by ζ_{sp} , the requirement is redundant; i.e., figure 114 is defined by F_S/n and ζ_{sp} . Multiplying figure 114's $(F_S/n)(s)/(F_S/n)_{\min}$ by the required minimum value of F_S/n gives curves which can be compared with the Level 1, 2, and 3 boundaries of steady (F_S/n) and ζ_{sp} from 4.2.1.1 and 4.2.8.1 for a 7 g aircraft. The shaded areas in figure 116 indicate regions where the F_S/n requirement is not redundant. It is noteworthy that dynamic F_S/n is not a consideration for Level 1 but has increasing influence for Levels 2 and 3, respectively. Lightly damped control system or structural modes that occur near the short-period frequency will increase the influence of the $(F_S/n)_{\min}$ requirement, i.e., the $(F_S/n)_{\min}$ boundaries in figure 116 will have a tendency to shift to the right in terms of ζ_{sp} (though not necessarily in terms of 4.2.1.2's equivalent ζ_{sp}). The T-33 test program of AFFDL-TR-66-163 involved pilot assessments of various short-period configurations in Category A Flight Phases.

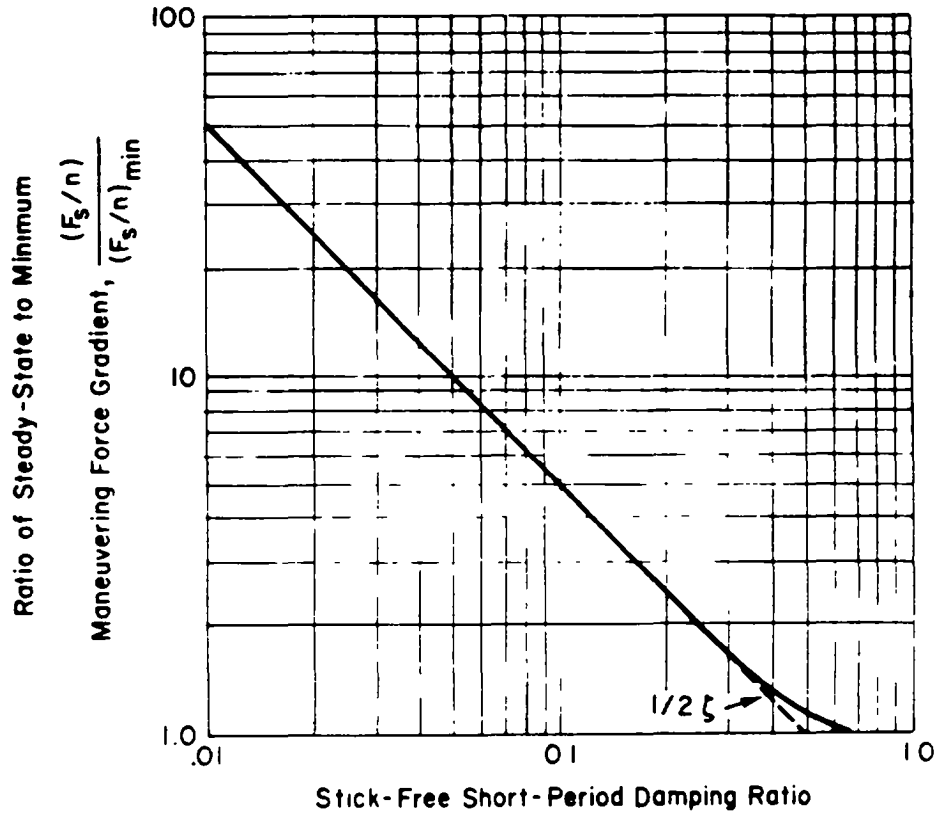
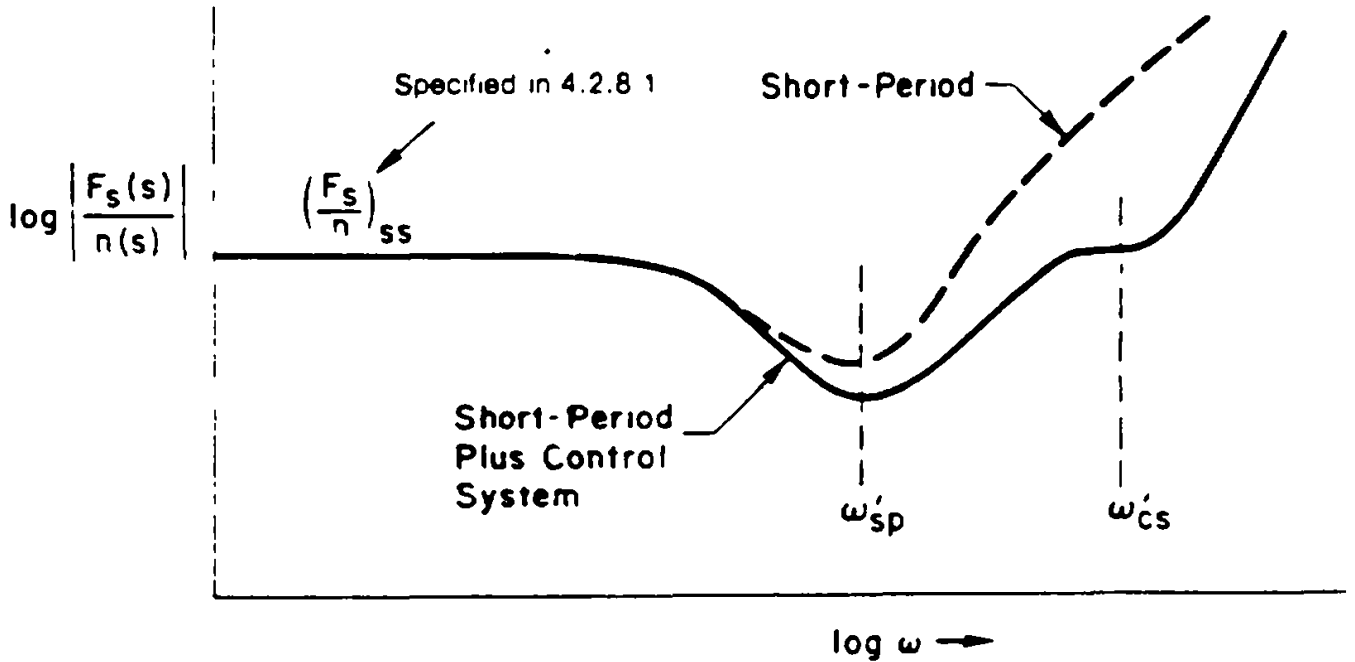

FIGURE 114. The ratio $(F_s/n)/(F_s/n)_{\min}$ vs. ζ_{sp} .



MIL-STD-1797A
APPENDIX A

FIGURE 115. Sketch of effect of control system on resonant dip.

MIL-STD-1797A
APPENDIX A

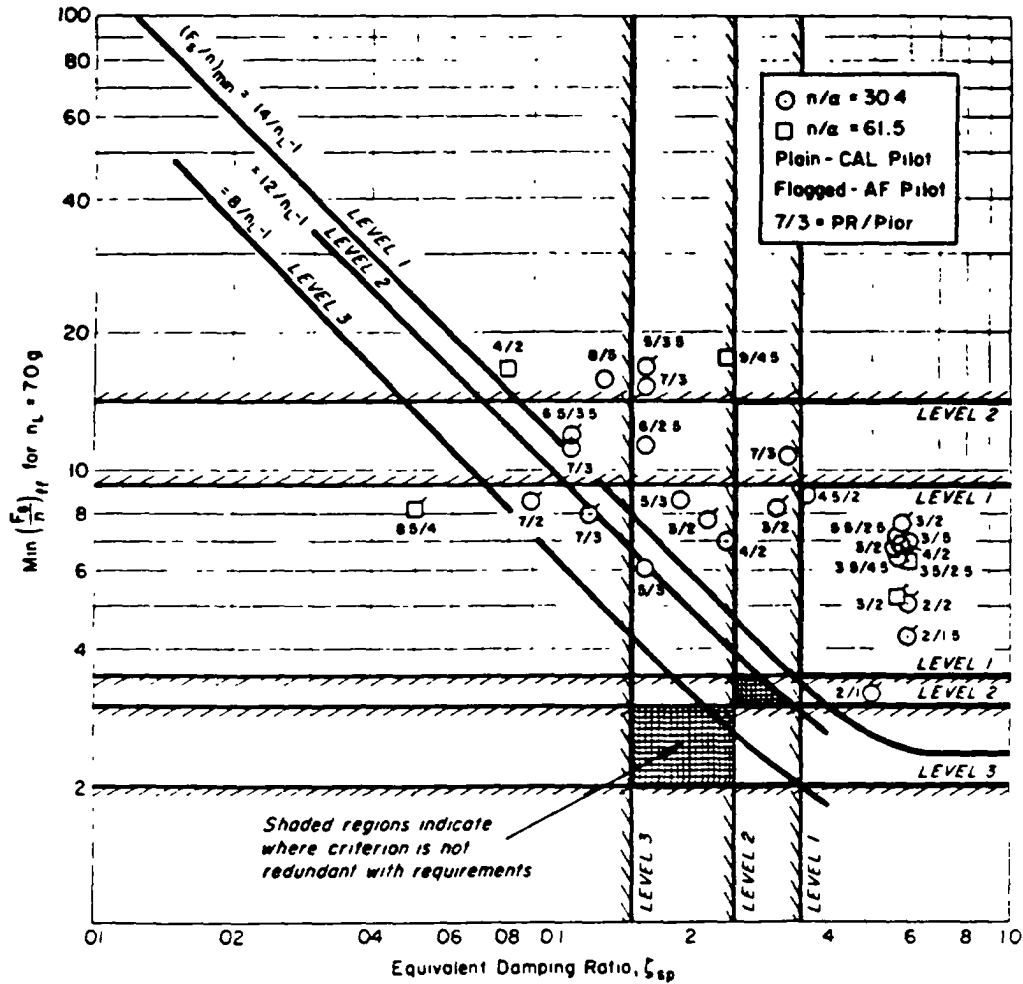

FIGURE 116. Comparison of $(F_s/n)_{\min}$ boundaries with $(F_s/n)_{SS}$ and ζ_{sp} for cases where $\omega_{sp} \ll \omega_{cs}$ (AFFDL-TR-66-163).

SUPPORTING DATA

The Calspan flight test programs using the variable-stability T-33 provide the only significant data base. Those tests in which pilots chose optimum F_s/n for the short-period configurations under consideration allow some insight into the applicability of 4.2.8.2.

Figure 116 shows data from AFFDL-TR-66-163. Only those cases for which ω_{sp} is Level 1 are plotted. The controller characteristics such as breakout and friction are also Level 1. Low-speed data from the reference are not included because a 2 g buffet limit may have influenced pilot ratings. The ratings given in figure 116, based on assessments of PIO tendencies, include both the handling qualities ratings (PR, from the CAL 10 point scale) and PIO ratings (PIOR, from figure 117). The PIO ratings are closely correlated with the Cooper-Harper pilot ratings, as one would expect, since the PIO scale is worded in terms of closed-loop pilot control. A later PIO rating scale, in the form of a decision tree, is presented in the discussion of the general qualitative PIO requirement, 4.1.11.6. That later rating scale is recommended for evaluating PIOs.

MIL-STD-1797A
APPENDIX A

DESCRIPTION	NUMERICAL RATING
No tendency for pilot to induce undesirable motions.	1
Undesirable motions tend to occur when pilot initiates abrupt maneuvers or attempts tight control. These motions can be prevented or eliminated by pilot technique.	2
Undesirable motions easily induced when pilot initiates abrupt maneuvers or attempts tight control. These motions can be prevented or eliminated but only at sacrifice to task performance or through considerable pilot attention and effort.	3
Oscillations tend to develop when pilot initiates abrupt maneuvers or attempts tight control. Pilot must reduce gain or abandon task to recover.	4
Divergent oscillations tend to develop when pilot initiates abrupt maneuvers or attempts tight control. Pilot must open loop by releasing or freezing the stick.	5
Disturbance or normal pilot control may cause divergent oscillation. Pilot must open control loop by releasing or freezing the stick.	6

FIGURE 117. PIO tendency rating scale.

As figure 116 indicates, there is a preference for high F_S/n when ζ_{sp} is low. This is not surprising, since very large gradients would tend to inhibit pilot over control and reduce the tendency to PIO. However, from the small amount of data at low ζ_{sp} in figure 116 it is difficult to conclude that the F_S/n requirement of 4.2.8.2 is necessary. There is no clear degradation ratings at low ζ_{sp} as F_S/n is reduced, nor is there data at low ζ_{sp} and low F_S/n to show that the pilot would consider this condition to be worse.

Figure 118 supports the conclusion from figure 116, i.e., there is a preference for large gradients at low damping but little to support the need for the dynamic F_S/n requirement. These data, from the tests of Neal and Smith (AFFDL-TR-70-74), include those configurations for which both equivalent ω_{sp} and τ_e were Level 1 in value. The pilot ratings are based on the Cooper-Harper scale, and the PIO ratings on the scale of figure 117. Thus, basis for this requirement remains theoretical with the additional thought that it may catch PIO tendencies in some higher-order systems that might otherwise escape detection until extensive flight experience has accumulated.

MIL-STD-1797A
APPENDIX A

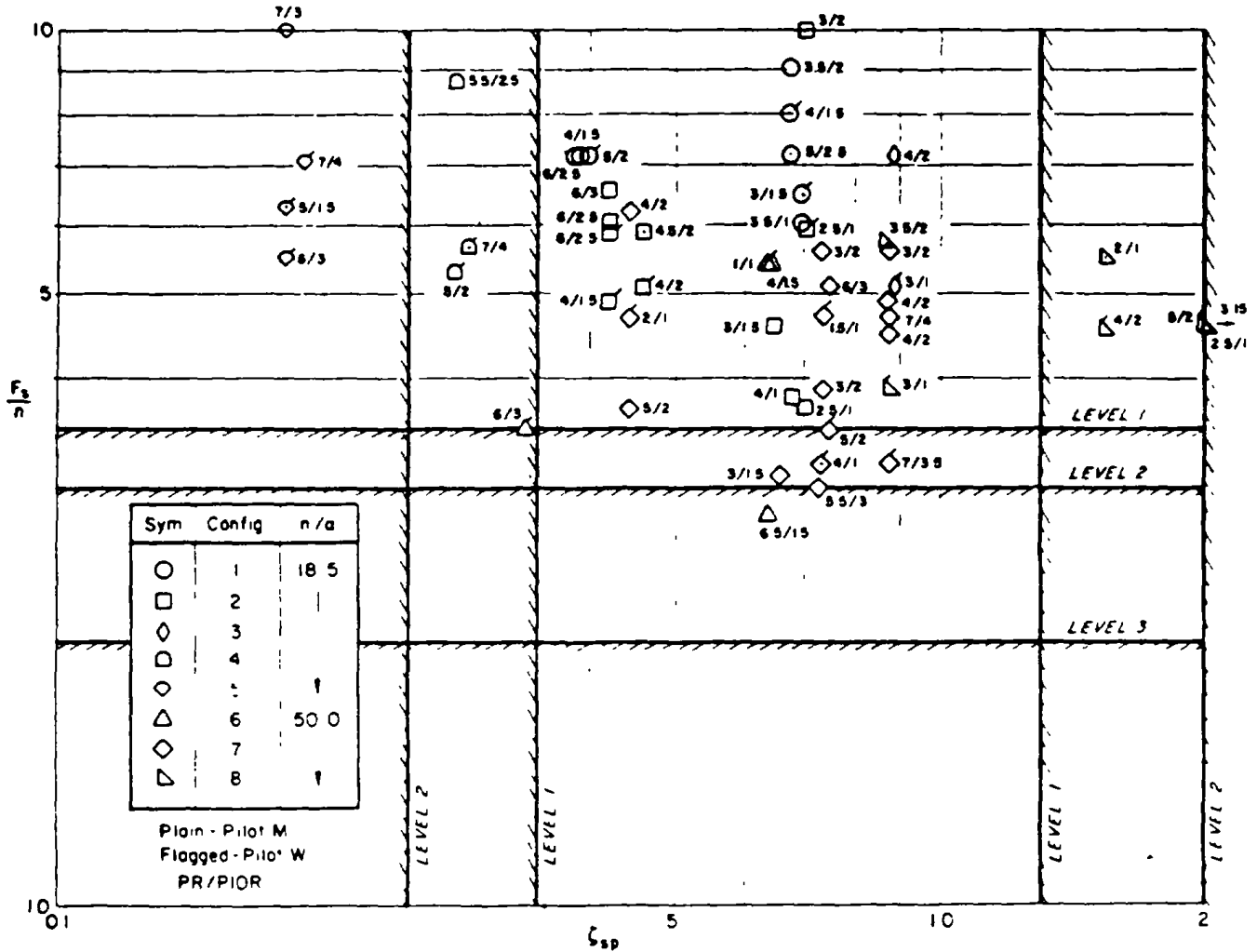

FIGURE 118. T-33 data from AFFDL-TR-70-74 (Level 1 equivalent ω_{sp} , τ_e).

REQUIREMENT LESSONS LEARNED

The data used in AFFDL-TR-69-72 are re-examined here. Figures 119 and 120 are reproduced from AFFDL-TR-69-72.

Figure 119 is a good illustration of lessons learned regarding the need for control system modification. In each case the airplane with the original control system exhibited strong PIO tendencies in the high-speed, low-altitude flight regime. A modified control system was tried in each airplane, which significantly improved the situation. The majority of the points on figure 119 are for the A4D-2 (Douglas Aircraft Co LB-25452). The T-38A and F-4C data are from flight test (Investigation and Elimination of PIO Tendencies in the Northrop T-38A and FTC-TR-67-19, respectively). With the exception of the T-38A, there are no pilot ratings or detailed pilot comments available. It is only known that the shaded points of figure 119 are associated with strong PIO tendencies. The solid line for $(F_s/n)_{\min} = 1.4 \text{ lb/g}$ divides the data very nicely.

MIL-STD-1797A
APPENDIX A

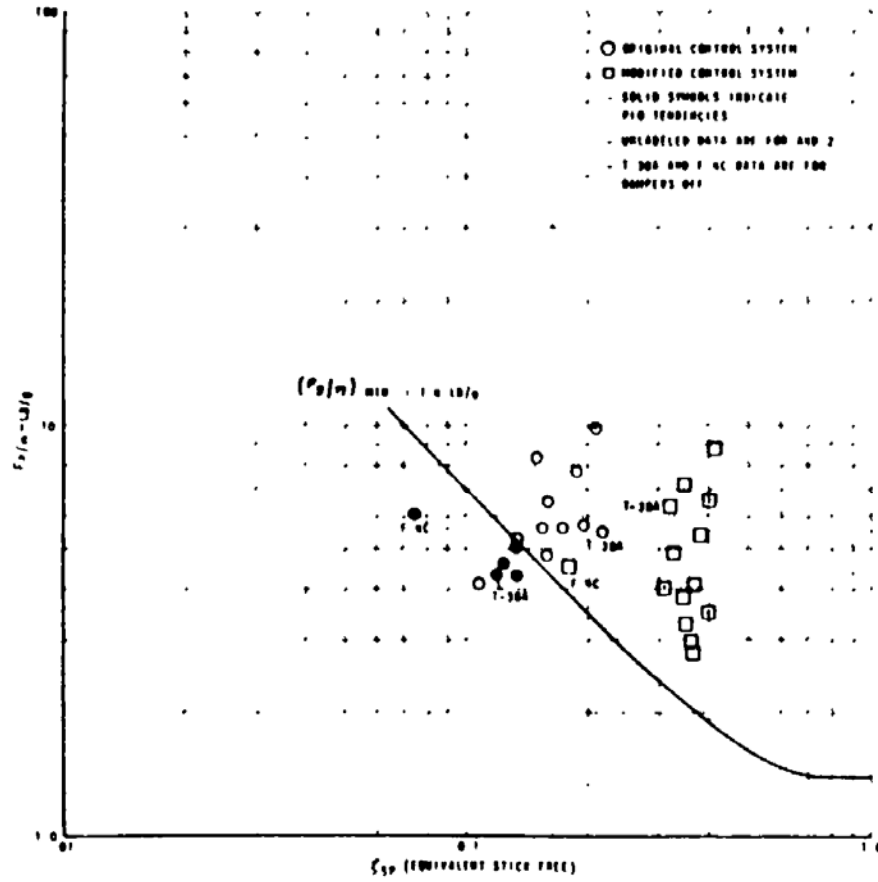

FIGURE 119. PIO characteristics of A4D-2, T-38A, and F-4C (Douglas Aircraft Co. LB-25452, FTC-TR-67-19, and "Investigation and Elimination of PIO Tendencies in the Northrop T-38A").

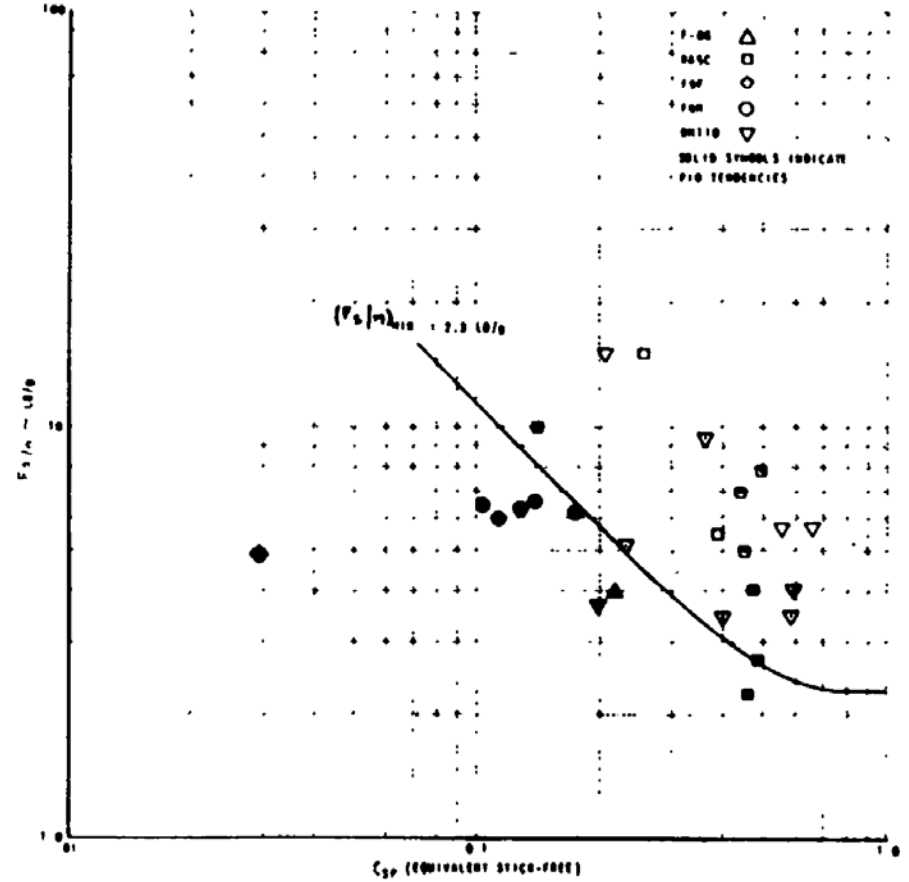

FIGURE 120. PIO characteristics of airplanes described in AGARD-CP-17.

MIL-STD-1797A
APPENDIX A

Some additional data on PIO tendencies are presented on figure 120, taken from AGARD-CP-17. The points are again rather crudely divided into those cases that exhibited PIO tendencies and those that did not. Since little is known about the severity of the PIO problems associated with these airplanes, figure 120 is used only to establish trends. As can be seen from the figure, a line of constant $(F_S/n)_{\min}$ also fits these data very well.

The lines of constant $(F_S/n)_{\min}$ in figure 119 and 120 were obtained from figure 116. Note, however, that while the $(F_S/n)_{\min}$ lines fit the data, so do lines for $\zeta_{sp} \approx 0.15$ or 0.2 and $F_S/n \approx 3.0$. And, as was stated earlier, many PIO tendencies are characteristically due to low ζ_{sp} . Therefore, the data of figures 119 and 120 do not reveal any requirement for a $(F_S/n)_{\min}$ specification. Such a requirement would be supported by obtaining test data in the shaded regions of figure 116 or by introducing lightly damped modes that influence the equivalent ζ_{sp} .

5.2.8.2 Pitch axis control forces-transient control force per g-verification.

Verification shall be by analysis, simulation and flight test.

VERIFICATION RATIONALE (5.2.8.2)

To obtain flight data, parameter identification methods can be used or the pilot can pump the stick sinusoidally at various frequencies. Several techniques have been employed to aid the pilot in this task. One method is described in FTC-TR-66-24, where the pilot visually follows an oscillating spot on the instrument panel. In other studies, oscillating aural tones have been fed to the pilot through earphones. Response to nonsinusoidal inputs can be analyzed readily via fast Fourier transform, e.g. Applied Time Series Analysis, Vol. I, Basic Techniques.

If the frequencies desired are not too high or too low, pilots can do an amazingly good job of moving the stick sinusoidally with no aids whatsoever. In addition, if the damping ratio is not too high, the pilot can find the resonant dip in the F_S/n versus frequency curve fairly accurately, by pumping at the frequency that gives the most aircraft response for the least effort.

VERIFICATION GUIDANCE

Testing is required with the most aft c.g., since for a given configuration and flight condition this is the condition for lowest F_S/n . For meaningful analysis or simulation, a linear approximation of the flight control system and aircraft must be accurate. In the end, however, PIO tendencies need to be evaluated in flight. Ground-based simulator evaluations may be of little value.

VERIFICATION LESSONS LEARNED

MIL-STD-1797A
APPENDIX A

4.2.8.3 Pitch axis control forces--control force variations during rapid speed changes.

When the aircraft is accelerated and decelerated rapidly through the operational speed range and through the transonic speed range by the most critical combination of changes in power, actuation of deceleration devices, steep turns and pullups, the magnitude and rate of the associated trim change shall not be so great as to cause difficulty in maintaining the desired load factor by normal pilot techniques.

REQUIREMENT RATIONALE(4.2.8.3)

This is intended to prevent unduly large pitch control force gradients with speed, which require excessive trimming or high steady control force.

REQUIREMENT GUIDANCE

The related MIL-F-8785C requirement is 3.2.1.1.2.

There are two kinds of problems for which this requirement is primarily intended. First, aircraft can have stick force and position gradients with speed which are so stable that considerable pilot effort is required during rapid speed-change maneuvers. Second, in the transonic region the local gradients may change so rapidly with Mach number that it is difficult for the pilot to maintain the desired pitch attitude or normal acceleration during rapid speed changes.

If the c.g. is allowed to be farther aft at supersonic speeds than at subsonic speeds, an adequate rate of c.g. shift must be provided for rapid transonic deceleration.

REQUIREMENT LESSONS LEARNED

The requirement is the result of operational experience with early supersonic airplanes. Although difficulties were experienced, enough data have never been collected for more than a qualitative requirement.

The AFTI-F-16 experienced a pitch-up tendency due to a rapid slowdown while performing high g rolls at transonic speeds.

5.2.8.3 Pitch axis control forces--control force variations during rapid speed changes-verification.

Verification shall be by analysis, simulation and flight test.

VERIFICATION RATIONALE (5.2.8.3)

Application of the requirement should be straightforward, except that its qualitative wording leaves demonstration of compliance purely subjective. There is no better way to apply it than simply performing acceleration and deceleration maneuvers typical of extreme task demands, including emergency decelerations, and asking the pilot about difficulties.

VERIFICATION GUIDANCE

Early analysis can determine transonic pitching and control forces to maintain 1 g flight as well as normal acceleration with fixed controls. The flight profile of the critical test for this requirement will be a function of gearing and feel mechanization, as well as of the normal and emergency maneuvers to be expected. Generally, the transonic trim change increase with lift coefficient, and so will be more pronounced at high load factors and high altitude.

Simulator and eventually flight evaluations, covering the operational speed range (and the transonic speed range, if applicable), should be conducted. Forward c.g. gives the largest magnitude of $C_{m\alpha}$, for stable aircraft; an unstable one undoubtedly will be highly augmented and so likely experience less difficulty.

VERIFICATION LESSONS LEARNED

MIL-STD-1797A
APPENDIX A

4.2.8.4 Pitch axis control forces--control force vs. control deflection.

The gradient of pitch-control force per unit of incremental pitch-control deflection shall be within the following range: _____. In steady turning flight and in pullups and pushovers at constant speed, the incremental control position shall be in the same sense (aft - more positive, forward - more negative) as that required to initiate the change. Dynamically, throughout the frequency range of pilot control inputs the deflection of the pilot's control must not lead the control force.

REQUIREMENT RATIONALE (4.2.8.4)

Both control force and control deflection provide pilot cues. This requirement is intended to assure consonance between the two and adequate control deflection cues where only control force is specified.

REQUIREMENT GUIDANCE

The related MIL-F-8785C requirements are 3.2.2.2, 3.2.2.2.2 and 3.2.2.3.2.

RECOMMENDED ALLOWABLE VALUES (FOR CATEGORY A FLIGHT PHASES)

	MINIMUM	MAXIMUM
Wheel and centerstick controllers	5 lb/in.	No data
Sidestick controllers	1 lb/deg.	2.5 lb/deg.

4.2.8.1 and 4.2.8.2 set limits on pitch control force. This requirement sets limits on the controller deflection corresponding to a given force. The Supporting Data show a need for such a requirement, and intuitive logic indicates some interrelationship among control forces, deflections, and motions. As with control force, any control position reversal in maneuvering flight (stick-fixed maneuvering instability) requires the pilot's concentration and promotes loss of control.

Limited flight test data strongly support a lower limit on F_S/δ_S (indeed, WADC-TR-55-299 suggests that F_S/δ_S should be 25 lb/in. or higher for centerstick controllers). The specific limits are directly related to F_S/n and control location (see 4.2.8.1). However, they are not well defined at this time.

Some guidance for designing sidestick controllers may be gained from figure 121 (reproduced with minor changes from AFFDL-TR-79-3126). A sidestick evaluation by the USAF Test Pilot School, using the variable-stability T-33 (with Level 1 short-period characteristics) produced a series of ratings and comments for varying F_S/n and F_S/δ_S . The lateral force deflection characteristics were varied as shown in table XVIII to maintain control harmony for the air-to-air evaluations (2 g bank-to-bank and 3.5 g wind-up turns). If the pilots commented that control harmony detracted from the rating given, variations in control harmony were evaluated. With the exception of the light F_S/n and large F_S/δ_S (Configurations 1 and 2), there is not a substantial variation in pilot ratings over the test matrix.

In general, pilots preferred increased control stick motion with decreased control force gradients and decreased control stick motion with increased control force gradients. Control configurations 13, 14, and 15 of figure 121 yielded the best results, both in pilot ratings and comments. Pilots indicated that control motions were noticeably large but not uncomfortable. These configurations were on the edge of the test matrix; thus, the extent of this favorable region was not determined and additional testing is warranted.

MIL-STD-1797A
APPENDIX A

Very Light (3.0)	13	9	5	1	
	No pitch bobble tendency but imprecise positioning. Avg of CH 3.7	Pitch and lateral are both too sensitive. Avg of CH 4.4	Pitch and lateral both a little too sensitive. Avg of CH 5.1	Pitch extremely sensitive. Lateral fair. Avg of CH 6.7	
	Light (4.0)	14	10	6	2
		Pitch and lateral steady and responsive. Motion noticeably large. Avg of CH 2.9	Pitch a little sensitive. Lateral bobble. Avg of CH 4.3	Slight pitch bobble. Better at higher g's. Lateral sluggish (cont. harmony). Avg of CH 4.5	Pitch too sensitive. Lateral wandering and sensitive. Avg of CH 6.0
Medium (5.0)	15	11	7	3	
	Motion noticeably large. No pitch bobble, slightly sluggish. Avg of CH 3.3	Very slight pitch bobble tendency, but good. Large lateral corrections difficult. Forces high & bobble. Avg of CH 4.4	Pitch steady once on tgt. Lateral forces high (cont. harmony). Avg of CH 3.85	Pitch a little sensitive. Lateral slow to respond. Avg of CH 5.0	
Heavy (8.6)	16	12	8	4	
	A/C very sluggish and forces uncomfortable. Avg of CH 5.0	A/C sluggish but stable. Forces heavy. Avg of CH 4.5	Pitch steady but forces too heavy. Lateral forces too heavy. Tiring. Avg of CH 4.3	Pitch very stable at higher g's, but forces tiring. Avg of CH 4.1	
	1.1	1.4	2.0	5.0	
	Control Force/Deflection Gradient (lb/deg)				

FIGURE 121. Pilot comments for air-to-air tasks with standard harmony (from AFFDL-TR-79-3126).

MIL-STD-1797A
APPENDIX A

TABLE XVIII. Category A control configurations for T-33 sidestick evaluations (AFFDL-TR-79-3126).

CONFIGURATION NUMBER	LONGITUDINAL		LATERAL	
	F_{es}/n	δ_{es}/F_{es} (deg/lb)	F_{as}/p	δ_{as}/F_{as} (deg/lb)
1	Very light	.2	Very light	.3
2	Light	.2	Light	.3
3	Medium	.2	Medium	.3
4	Heavy	.2	Heavy	.3
5	Very light	.5	Very light	.77
6	Light	.5	Light	.77
7	Medium	.5	Medium	.77
8	Heavy	.5	Heavy	.77
9	Very light	.7	Very light	1.08
10	Light	.7	Light	1.08
11	Medium	.7	Medium	1.08
12	Heavy	.7	Heavy	1.08
13	Very light	.91	Very light	1.43
14	Light	.91	Light	1.43
15	Medium	.91	Medium	1.43
16	Heavy	.91	Heavy	1.43

Configurations 4 and 7 were found to be good, but slightly inferior to Configurations 13, 14 and 15. Pilot comments indicated that the stick forces for Configuration 4 were tiring and uncomfortable. Though the boundaries were not completely determined, these comments imply that even heavier force gradients would be unacceptable. Configurations 1 and 2 were rated the poorest, characterized by longitudinal and lateral oversensitivity.

All of the remaining control configurations indicate that with medium control stick motion the control force gradient selected had essentially no effect on pilot ratings. However, pilot comments show a trend from oversensitivity to sluggishness as the control force gradient increased from very light to heavy.

The effect of breakout force on pilot ratings was investigated by increasing the breakout force from 1/2 lb to 1 lb for control Configurations 7 and 11. For Configuration 7 the average pilot ratings increased from 3.8 to 5, whereas for Configuration 11 the ratings remained essentially unchanged. Pilot comments indicated that the effect of increasing breakout was to increase the pitch sensitivity in an unfavorable way.

Recent USAF Test Pilot School experiments with the T-33 sidearm controller varied the force/deflection gradient F_s/δ_s and short-period frequency, ω_{sp} . F_s/n was 7 or 8 lb/g for the high ω_{sp} and 5 lb/g for the lower values of ω_{sp} in accordance with earlier results [see figure 106] as shown in table XIX. A summary of average pilot ratings (3 pilots) and commentary is given in figure 122 for the gross acquisition task and in figure 123 for the fine tracking maneuver.

MIL-STD-1797A
APPENDIX A

TABLE XIX. Experimental test points used in sidearm controller evaluations.

PHASE I; AIR-TO-AIR TEST POINTS
(13,000 FT MSL, 300 KIAS)

CONFIGURATION	Ω_{sp} (rad/sec)	LONGITUDINAL FORCE/DEFLECTION (lb/deg)	LONGITUDINAL FORCE/DEFLECTION (lb/g)	LATERAL FORCE/DEFLECTION (lb/deg)
A (Baseline)	5.6	1.7	8	1.8
B	5.6	3.3	8	1.8
C	5.6	1.1	8	1.8
D	2.6	3.3	5	.95
E	2.6	1.7	5	.95
F	2.6	1.1	5	.95
G	1.8	3.3	5	.95
H	1.8	1.7	5	.95
I	1.8	1.1	5	.95

PHASE 11; AIR-TO-AIR TEST POINTS
(13,000 FT MSL, 300 KIAS)

CONFIGURATION	Ω_{sp} (rad/sec)	LOGITUDINAL FORCE/DEFLECTION (lb/deg)	LOGITUDINAL FORCE/DEFLECTION (lb/g)	LATERAL FORCE/DEFLECTION (lb/deg)
A	5.6	1.7	8	1.8
B	5	3.3	7	1.8
C	5	1.7	7	1.8
D	5	1.1	7	1.8
E	3.5	3.3	5	1.8
F	3.5	1.7	5	1.8
G	3.5	1.1	5	1.8
H	2.6	1.7	5	.95

MIL-STD-1797A
APPENDIX A

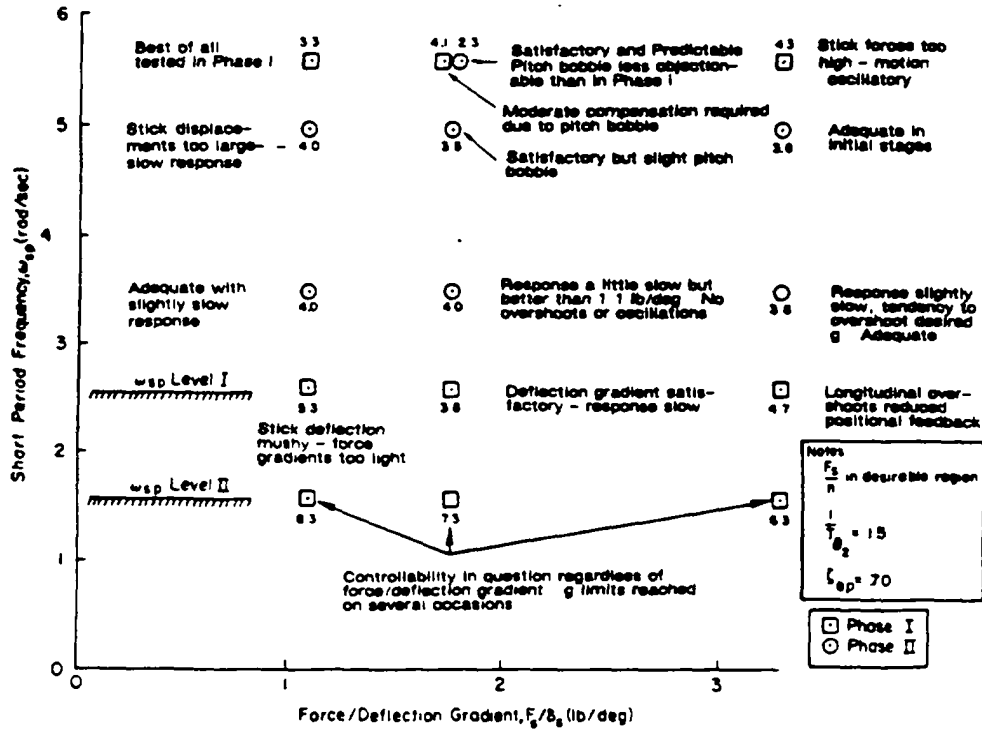

FIGURE 122. Average pilot ratings for gross acquisition task.

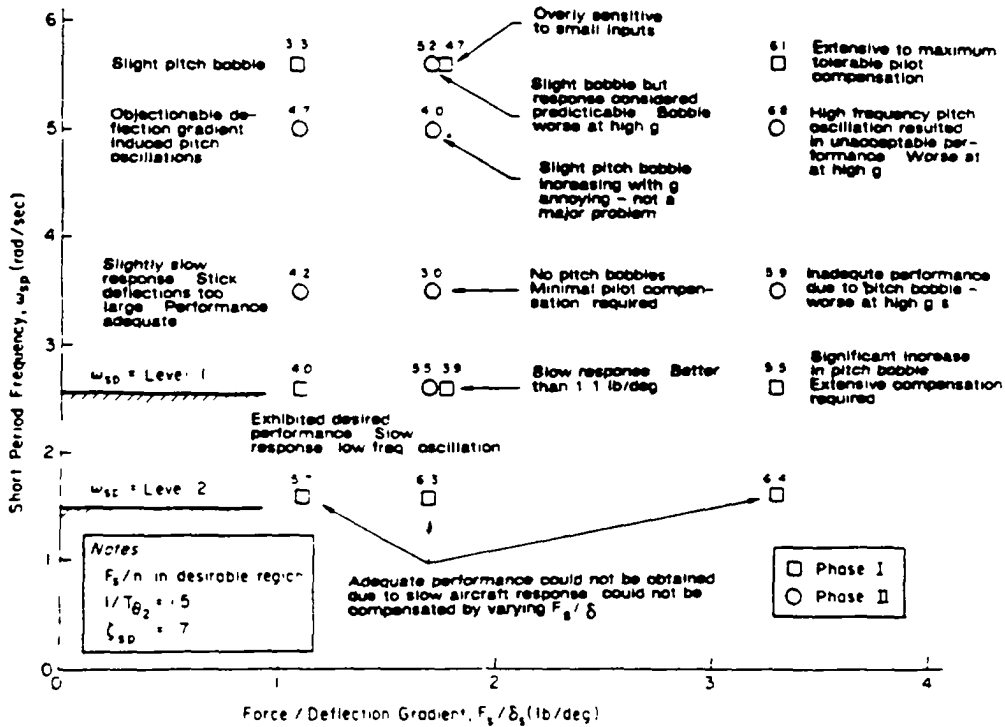

FIGURE 123. Average pilot ratings for fine tracking tasks.

MIL-STD-1797A
APPENDIX A

The poor pilot ratings for the low short-period frequency cases, $\omega_{sp} = 1.6$ rad/sec, are expected based on 4.2.1.2. However, the ratings for the lower values of F_S/δ_S are worse than for Level 2, indicating that failure modes should be a consideration when contemplating light force/deflection gradients.

For ω_{sp} in the Level 1 region ($\omega_{sp} \geq 2.55$), larger values of F_S/δ_S (i.e., approaching a force stick) result in rapidly degraded pilot opinion in the fine tracking task (see figure 123).

The optimum value of F_S/δ_S is seen to be about 1.7 lb/deg until $\omega_{sp} \geq 5$ rad/sec, at which time the data indicate that decreasing F_S/δ_S is desirable (see figure 122).

There is little or no recent data available for analysis. The following discussion is taken directly from AFFDL-TR-69-72, with a few words added at the end. Data for sidestick controllers has been presented above.

The flying qualities investigations of WADC-TR-55-299, AFFDL-TR-67-51, AFFDL-TR-65-210, WADC-TR-57-719, WADC-TR-56-258, and AFFDL-TR-68-91 all included variations of control position per g as well as control force per g. AFFDL-TR-67-51 and AFFDL-TR-65-210 deal with the landing approach flight phase, while all the others are for Category A Flight Phases.

Both AFFDL-TR-67-51 and AFFDL-TR-65-210 indicate unfavorable pilot comments when the control motions required to maneuver the airplane become too large. Since these investigations were specific simulations of some early C-5A configurations, the short-period natural frequency was below the minimum Level 1 limit for Category C Flight Phases. When the short-period frequency is low, the pilots tend to overdrive the airplane with large pulse-like inputs to speed up the response. Therefore the pilots might not have disliked the control motion gradients as much if the short-period response had been faster. Because of the uncertainties caused by the low short-period frequencies, and because of the limited amount of data, no attempt was made to place quantitative limits on control motion gradients for Category C Flight Phases.

Working under the assumption that there are lower limits on F_S/δ_S (upper limits on δ_S/F_S), the Level 1 and Level 2 boundaries were initially drawn as a best fit to the data of figure 124. There are not sufficient data to define a Level 3 limit. Although the only data plotted were those having Level 1 values of F_S/n , there are poorly rated configurations from WADC-TR-55-299 and WADC-TR-57-719 which lie inside the Level 1 F_S/δ_S boundary.

Because of strong objections from the manufacturers, the Level 1 and 2 limits shown in figure 124 were reduced to 5 lb/in. Examples of "good" operational aircraft were produced with indicated gradients as low as 5 lb/in. The requirement for a force/deflection gradient of at least 5 lb/in. has been retained as a recommended lower limit from Paragraph 3.2.2.2.2 of MIL-F-8785C. This number seems to have originated more from a rule of thumb based on experience than from hard data. Hence more experimental data are deemed highly desirable.

The minimum values specified for dynamic F_S/n in 4.2.8.2 and ζ_{sp} in the 4.2.1.2 equivalent systems criteria are not sufficient to prevent the occurrence of a PIO. In fact, there are documented cases of PIO-prone aircraft with Level 1 values of $(F_S/n)_{min}$ and $\zeta_{sp_{min}}$. The feel system, which allowed δ_S to lead F_S , was found to be responsible for these PIOs. The details of these cases provide valuable design guidance and are discussed at some length in the "Lessons Learned" subsection.

MIL-STD-1797A
APPENDIX A

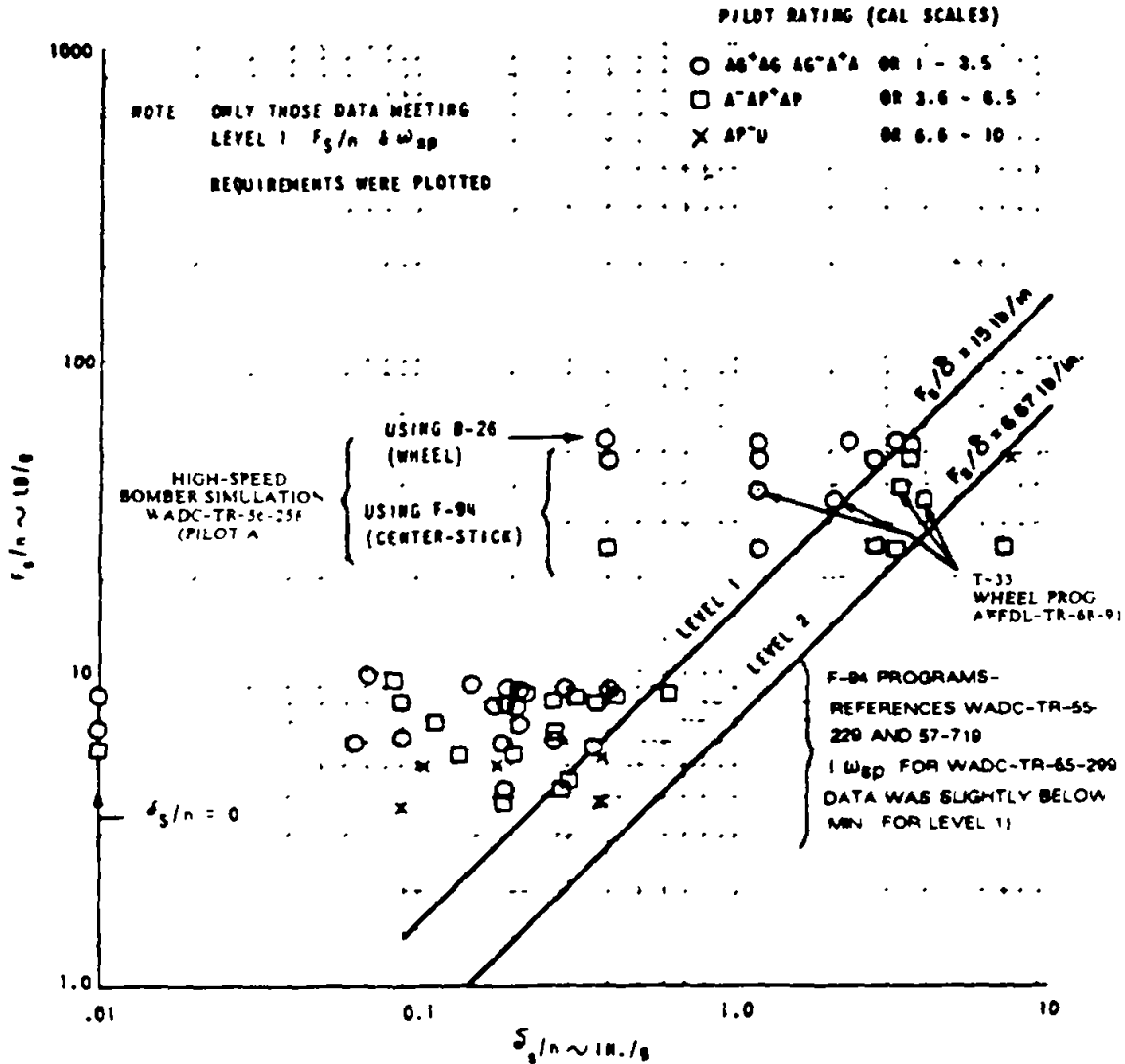

FIGURE 124. Control force per control displacement, Category A Flight Phases--centerstick (from AFFDL-TR-69-72).

REQUIREMENT LESSONS LEARNED

The F-16 employs a sidearm controller with only a small amount of motion (F_s/δ_s very high), which clearly would not meet the requirements of this section. Although a change from the original essentially fixed stick was deemed necessary, F-16 pilots seem to have adapted to the essentially fixed sidestick. However, before accepting such a controller as being Level 1, it should be noted that these pilots had no alternative but to adapt. The T-33 subject pilots (figure 121) did not feel that extreme force gradients were desirable when given the opportunity to compare with gradients across the spectrum.

An excellent treatise by Peter Neal on the historical development and analytical aspects of the dynamic requirement is given in AFFDL-TR-69-72 and "Influence of Bobweights on Pilot-Induced Oscillations". Basically, the requirement stems from and reflects experience with production bobweight-augmented elevator control systems. Such systems have the virtue of keeping F_s/n relatively constant, i.e., preventing

MIL-STD-1797A
APPENDIX A

large changes with attitude and loading (c. g.) . Early versions, involving manual control, featured elevators with near 100 percent aerodynamic balance. Later versions featured full-power hydraulics with spring and bellows feel systems. More recently, n_z feedback directly to the servo valve rather than to the control stick has given a response feel system without contributing phase shift between control force and control deflection. Both documents provide a feedback-control-analysis basis for studying the problems and fixes associated with bobweights in the specific context of PIO. Similar, earlier efforts by others are referenced; however, even earlier work on bobweight effects in unpowered elevator control systems, of NACA and RAE origin, is not cited. The main emphasis is to explain, by virtue of analysis, the particular problems encountered by a succession of example airplanes: P-63A (NACA Memo Report L6E20), A4D-2 (Douglas Aircraft Co. LB-25452), T-38A ("Investigation and Elimination of PIO Tendencies in the Northrop T-38A" and Report of the T-38 Flight Control System PIO Review Board) and F-4 (FTC-TR-67-19).

Pertinent conclusions reached by Neal ("Influence of Bobweight on Pilot-Induced Oscillations") are:

1. The use of a control-system bobweight without consideration of its effects on the aircraft's dynamics can lead to serious PIO problems
2. Potential PIO problems due to a bobweight can be minimized by increasing the sensitivity of the bobweight to pitch acceleration, as by blending forward and aft bobweights, using the following rule of thumb:

$$l_b = g[\omega_{sp}^2 / (n/\alpha)]^{-1} + l_{CR}$$

Taking the highest minimum $\omega_{sp}^2 / (n/\alpha)$, for Category A (3.2.1.2 of MIL-F-8785C)

$$l_b = 115 + l_{CR}$$

where

- l_b is the distance (in feet) of an equivalent point-mass bobweight ahead of the c.g.:

$$l_b = g \cdot \frac{\text{bobweight stick force due to unit } \ddot{\theta}}{\text{bobweight stick force due to unit } n_z}$$

- l_{CR} is the distance (in feet) of the instantaneous center of rotation for control inputs ahead of the c.g.: $-Z_{\delta}/M_{\delta}$.
3. When this criterion is satisfied, the contribution of the bobweight to stick force per g may still be limited by the fact that the closed-loop feel-system roots can be driven unstable. This problem can usually be improved by the use of a viscous stick damper
 4. The final control-system design should be checked against other longitudinal requirements. Such checks may in fact show the undesirability of using viscous stick damping because of associated lags in response to stick inputs.

5.2.8.4 Pitch axis control forces - control force vs. control deflection - verification.

Verification shall be by analysis, simulation and flight test.

VERIFICATION RATIONALE (5.2.8.4)

Flight testing performed to demonstrate compliance with control force per g (4.2.8.1) should include measurements of δ_s/n . For discussion of flight test techniques, see 5.2.8.1. When the force gradient, gearing or both are nonlinear, the critical deflection should be found.

MIL-STD-1797A
APPENDIX A

Given some very basic instrumentation⁵ it is a simple matter to obtain the phase relationship between control force and control position via a pilot-generated frequency sweep at each selected flight condition. The phase relationship between control position and control force can be obtained from the frequency sweep data via a Fast Fourier Transform computer program. As a general rule the frequency range of interest will be between 0.5 and 10 rad/sec.

VERIFICATION GUIDANCE

Qualitatively, pilot comments relating to control forces which are initially too light even though $(F_S/n)_{\min}$ and ζ_{sp} are Level 1 provide a clue to the fact that this requirement is being violated.

Demonstrating compliance with this dynamic requirement requires a quantitative determination of the phase relationship between control deflection and force. However, if the control forces clearly lead control deflection based upon pilot comments, the requirement should be considered satisfied. It should be emphasized that due to actual control system effects such as friction, hysteresis, etc., ground-based simulation may not be adequate and therefore flight test results are needed.

VERIFICATION LESSONS LEARNED

⁵ A control position potentiometer and strain gauge to measure control force.

MIL-STD-1797A
APPENDIX A

4.2.8.5 Pitch axis control breakout forces.

Breakout forces, including friction, preload, etc., shall be within the following limits: These values refer to the cockpit control force required to start movement of the control surface.

REQUIREMENT RATIONALE (4.2.8.5)

Some small effort should be necessary to deflect a control out of its neutral position. This in combination with centering serves as the major initial pilot cue of control motion.

REQUIREMENT GUIDANCE

The related MIL-F-8785C requirement is paragraph 3.5.2.1.

Several studies (NADC-ED-6282 and AFFDL-TR-72-141) have substantiated the upper limits on breakout forces in table XX. Design for the lower values is recommended, since operation with large breakout forces could contribute to pilot fatigue.

TABLE XX. Recommended pitch axis breakout forces (lb).

CONTROL	CLASSES I, II-C IV		CLASSES II-L, III	
	MINIMUM	MAXIMUM	MINIMUM	MAXIMUM
Centerstick	1/2	3	1/2	5
Wheel	1/2	4	1/2	7
Sidestick	1/2	1	1/2	1

Values are for Levels 1 and 2; Upper limits are doubled for Level 3

REQUIREMENT LESSONS LEARNED

5.2.8.5 Pitch axis control breakout forces-verification.

Verification shall be by analysis, simulation and test.

VERIFICATION RATIONALE (5.2.8.5)

Measurement of breakout forces in the aircraft on the ground will ordinarily suffice in lieu of actual flight measurement, provided that qualitative agreement between ground measurement and flight observation can be established.

VERIFICATION GUIDANCE

Factors such as temperature and vibration could affect breakout forces. Flight control system failures should also be considered.

VERIFICATION LESSONS LEARNED

4.2.8.6 Pitch axis control force limits

4.2.8.6.1 Pitch axis control force limits -- takeoff.

With the trim setting optional but fixed, the pitch-control forces required during all types of takeoffs for which the aircraft is designed, including short-field takeoffs and assisted takeoffs such as catapult or rocket-augmented, shall be within the following limits: _____. The term takeoff includes the ground run, rotation, and lift-off, the ensuing acceleration to $V_{max}(TO)$, and the transient caused by assist cessation. Takeoff encompasses operation both in and out of ground effect. Takeoff power shall be maintained until $V_{max}(TO)$ is reached, with the landing gear and high-lift devices retracted in the normal manner at speeds from $V_{omin}(TO)$ to $V_{omax}(TO)$.

REQUIREMENT RATIONALE (4.2.8.6.1)

Limits on maximum push and pull forces required for takeoff should be lower than those allowed for other operations by the F_S/n values of 4.2.8.1. This is to assure that the pitch control input for takeoff need not be abrupt or require excessive effort or two-handed operation.

REQUIREMENT GUIDANCE

The related MIL-F-8785C requirement is paragraph 3.2.3.3.2.

Recommended values for aircraft with centerstick or wheel controllers:

Nose-wheel and bicycle-gear aircraft

Classes I, IV-C: 20 pounds pull to 10 pounds push

Classes II-C, IV-L: 30 pounds pull to 10 pounds push

Classes II-L, III: 50 pounds pull to 20 pounds push

Tail-wheel aircraft

Classes I, II-C, IV: 20 pounds push to 10 pounds pull

Classes II-L, III: 35 pounds push to 15 pounds pull

For sidestick controllers: the force shall not be objectionable to the pilot.

The procuring activity may wish to specify additional procedures, as for fuel conservation or noise abatement.

The force limits for this paragraph are intended to assure adequate control force characteristics at takeoff. Pitch forces in takeoff should not normally place great demands on the pilot, either in the form of large pull forces (requiring two-handed operation and possibly causing abrupt responses) or large unnatural push forces. The limits are strictest for small, highly maneuverable (Class I) aircraft and relaxed for large (Class III) aircraft, but 50 lb may well be too high for the majority of female pilots. For tail-wheel aircraft the push forces required to raise the tail may be larger than pull forces. At this time there are insufficient data to suggest limits for sidestick controllers, but it is clear that acceptable values will be quite small when compared to limits on the centerstick.

For comparison, FAR Part 23 lists 60 lb as the maximum stick force for temporary application. There are no known systematic flight tests, but these requirements are an outgrowth of service experience.

MIL-STD-1797A
APPENDIX A

REQUIREMENT LESSONS LEARNED

As with the supporting data, little information can be found for existing flight vehicles. AFFDL-TR-72-141, a validation of MIL-F-8785B using a Class III-L airplane (P-3B), indicates pilot support for the limits for Class III, nose-wheel-equipped aircraft.

5.2.8.6.1 Pitch axis control force limits--takeoff--verification.

Verification shall be by analysis, simulation and flight test.

VERIFICATION RATIONALE (5.2.8.6.1)

The final proof of compliance will be flight testing. Analysis and simulation may be used for early guidance, but these will be only as good as the initial estimates of elevator control power and aircraft performance characteristics.

VERIFICATION GUIDANCE

Verification will include not only normal takeoffs, but demonstration of performance guarantees and any takeoffs which may be peculiar to the aircraft mission requirements. Tests should be conducted at the conditions for most forward and most aft center-of-gravity positions, and will cover the velocity range from 0 to $V_{\max}(\text{TO})$. Lightweight will give more rapid acceleration and a lower takeoff speed, which may be factors pro or con (refer to the 4.2.7.3 and 5.2.7.3 discussions).

VERIFICATION LESSONS LEARNED

MIL-STD-1797A
APPENDIX A

4.2.8.6.2 Pitch axis control force limits--landing.

The pitch control forces for landing shall be less than _____ with the aircraft trimmed for the approach Flight Phase at the recommended approach speed. This limit applies both in and out of ground effect.

REQUIREMENT RATIONALE (4.2.8.6.2)

The forces required in landing should always be natural (that is, pull for flare) and should be small enough to allow one-handed operation without placing excessive demands on the pilot.

REQUIREMENT GUIDANCE

The related MIL-F-8785C requirement is paragraph 3.2.3.4.1.

Recommended values for centerstick or wheel controllers:

Classes I, II-C, IV:	35 pounds pull
Classes II-L, III:	50 pounds pull

For sidestick controllers the forces shall not be objectionable to the pilot.

The limits for aircraft with centerstick or wheel controllers are intended to prevent unreasonable demands on the pilot at landing, where one-handed operation is almost mandatory and corrections are continually made.

Although some pilots hold a control force, trim in approach (after extension of gear/flaps, etc., but before landing flare) is a generally valid standard reference condition. The recommendations explicitly include landing conditions in and out of ground (taken to include carrier deck, sea, cloud, etc.) effect. Crosswind also may reduce or negate ground effect.

These force limits are more restrictive than the civil requirements: FAA FAR Part 25 allows 75 lbs and FAA FAR Part 23, 60 lbs for stick or 75 lbs for wheel controllers (the quoted values for short-term application). However, operational experience shows support for lower limits for continuous maneuvering. For one thing, this allows keeping some pull force at equilibrium conditions on approach, as already mentioned. Again, the recommended maximum force may be too high for the average female pilot.

REQUIREMENT LESSONS LEARNED

A lack of commentary on the recommended limits suggests that they are acceptable.

5.2.8.6.2 Pitch axis control force limits--landing -verification.

Verification shall be by analysis, simulation and flight test.

VERIFICATION RATIONALE (5.2.8.6.2)

Ultimately, compliance must be proven through flight test at forward c.g.

VERIFICATION GUIDANCE

Analysis and simulation are subject to the accuracy of aerodynamic estimates in ground effect. The flight test should encompass approach or that part of preparation for landing that involves gear/flap extensions, power adjustment, and pitch trim over velocities from 1.3 V_S , at the most forward center of gravity position. Both power-on and -off landings, if applicable, should be performed, to assure that the power setting does not affect the force characteristics too greatly. Generally, the most stable loading and configuration will be critical. Refer to the 4.2.7.4 and 5.2.7.4 discussions.

MIL-STD-1797A
APPENDIX A

VERIFICATION LESSONS LEARNED

MIL-STD-1797A
APPENDIX A

4.2.8.6.3 Pitch axis control force limits--dives.

With the aircraft trimmed for level flight at speeds throughout the Service Flight Envelope, the control forces in dives to all attainable speeds within the Service Flight Envelope shall not exceed ____ (a) _____. In similar dives, but with use of trim following the dive entry, it shall be possible with normal piloting techniques to maintain the forces within: ____ (b) _____.

With the aircraft trimmed for level flight at V_{MAT} but with use of trim optional in the dive, it shall be possible to maintain the pitch control force within the following limits in dives to all attainable speeds within the Permissible Flight Envelope: ____ (c) _____. The force required for recovery from these dives shall not exceed ____ (d) _____. Trim and deceleration devices, etc., may be used to assist in recovery if no unusual pilot technique is required.

REQUIREMENT RATIONALE (4.2.8.6-3)

As a frequently used but peculiar flight operation, the dive is subject to separate requirements to keep control forces within reason.

REQUIREMENT GUIDANCE

The related MIL-F-8785C requirements are paragraphs 3.2.3.5, 3.2.3.6 and 3.6.1.2.

Recommended values are listed by letter in table XXI. Both push and pull force limits must be stated. Outside the Service Flight Envelope, flight safety still requires some force limit for control and recovery, throughout the Permissible Flight Envelope.

Operation of manual trim systems implies that the dive can be a sustained (rather than momentary) maneuver, so the trim should be effective in substantially reducing pitch forces. The force limit without retrimming effectively limits the gradient of control force with speed while maneuvering throughout the Operational and Service Flight Envelopes, and further provides a measure of protection against trim failures in dives. Some of the limits may be too much for the average female pilot.

Besides limiting the permissible amount of static stability, this requirement serves to limit instabilities such as transonic tuck in the Permissible Flight Envelope, outside the Service Flight Envelope, where most of the other flying qualities requirements do not apply. See maximum service (4.1.4.2) and permissible (4.1.4.3) speeds. For trim-system stalling, see 4.1.3.3.

REQUIREMENT LESSONS LEARNED

The limited dive testing of AFFDL-TR-72-141, using a Class III airplane (P-3B), supports the one-handed wheel push force limit of 50 pounds.

5.2.8.6.3 Pitch axis control force limits--dives-verification.

Verification shall be by analysis, simulation and flight test.

MIL-STD-1797A
APPENDIX A

TABLE XXI. Recommended force limits for dives and recovery from dives.

LETTER	CONTROLLER	FORCE (lb)	
		PUSH	PULL
(a)	Centerstick	50	10
	Sidestick	*	*
	Wheel	75	15
(b)	Centerstick	10	10
	Sidestick	*	*
	Wheel	20**	20**
(c)	Centerstick	50	35
	Sidestick	*	*
	Wheel	50	35
(d)	Centerstick	120	120
	Sidestick	*	*
	Wheel	120	120

* Limits for sidestick controllers have not been established; however, the forces must be acceptable to the pilot.

** Two-handed operation. If operation of the trim system requires removal of one hand, the force limits shall be as for centerstick.

VERIFICATION RATIONALE (5.2.8.6.3)

Compliance must ultimately be proven through flight test. Analysis may be used for initial verification.

VERIFICATION GUIDANCE

The tests and analyses should be conducted over the following range of aircraft and flight conditions: a center of gravity range from most forward (combined with heaviest aircraft weight) to most aft (combined with lightest aircraft weight); for the Service Flight Envelope altitudes from 2000 ft above MSL to the maximum service altitude, for the range of minimum to maximum service speeds; for the Permissible Flight Envelopes altitudes as required by the procuring activity or the ranges of the Permissible Flight Envelope, over the speed range from V_{MAT} to the maximum permissible.

VERIFICATION LESSONS LEARNED

MIL-STD-1797A
APPENDIX A

4.2.8.6.4 Pitch axis control force limits--sideslips.

With the aircraft trimmed for straight, level flight with zero sideslip, the pitch-control force required to maintain constant speed in steady sideslips with up to __ (a) _ pounds of pedal force in either direction, and in sideslips as specified in the Operational Flight Envelope, shall not exceed the pitch-control force that would result in a 1 g change in normal acceleration. In no case, however, shall the pitch-control force exceed _ (b) _. If a variation of pitch-control force with sideslip does exist, it is preferred that increasing pull force accompany increasing sideslip, and that the magnitude and direction of the force change be the same for right and left sideslips. For Level 3, throughout the Service Flight Envelope there shall be no uncontrollable pitching motions associated with the sideslip maneuvers discussed above.

REQUIREMENT RATIONALE (4.2.8.6.4)

There are two primary reasons for having requirements for maximum longitudinal forces in sideslips: to insure that small amounts of sideslip inadvertently developed during normal operations do not result in large or possibly dangerous angle-of-attack changes; and to limit the longitudinal corrections required when the pilot intentionally changes the sideslip angle, as in a crosswind landing.

REQUIREMENT GUIDANCE

The related MIL-F-8785C paragraph is 3.2.3.7.

Recommended values:

- (a) For pedal force of 50 pounds or less
- (b) Centerstick controllers: 10 pounds pull to 3 pounds push
Sidestick controllers: Acceptable to the pilot
Wheel controllers: 15 pounds pull to 10 pounds push

This requirement limits the unwanted coupling of pitch to sideslip to an acceptable level. This keeps pilot workload in crosswinds (or in failures, such as one-engine-out operation on multi-engine aircraft) to a minimum.

The Level 3 requirement stipulates that pitching motions due to sideslip shall not further aggravate a Level 3 aircraft into an uncontrollable state. Uncontrollable is used here to indicate a divergent pitch response and should not be interpreted to mean a mild uncommanded buffet or oscillation.

REQUIREMENT LESSONS LEARNED

AFFDL-TR-72-141, using a Class III aircraft (P-3B, shows support for the pull limit of 15 pounds for wheel controllers.

5.2.8.6.4 Pitch axis control force limits--sideslips-verification.

Verification shall be by analysis, simulation and flight test.

VERIFICATION RATIONALE (5.2.8.6.4)

Flight test is needed to verify that all the significant contributions have been accounted for: production asymmetries, engine gyroscopic moments, propeller slipstream, etc.

MIL-STD-1797A
APPENDIX A

VERIFICATION GUIDANCE

Analysis and flight test should encompass the extremes of the operational altitude range and the service flight speed range. The Level 3 requirement may be difficult to verify in practice, except in those cases where external failure conditions (e.g., one engine out) would create the Level 3 state.

VERIFICATION LESSONS LEARNED

MIL-STD-1797A
APPENDIX A

4.2.8.6.5 Pitch axis control force limits--failures.

Without retrimming, the change in longitudinal control force required to maintain constant attitude following complete or partial failure of the flight control system shall not exceed the following limits:

_____.

REQUIREMENT RATIONALE (4.2.8.6.5)

Flight control system failures should not cause abrupt or severe changes in the trim state of the aircraft. The ability to retain reasonable control is measured in terms of demands on the pilot to maintain trim conditions.

REQUIREMENT GUIDANCE

The related MIL-F-8785C requirement is 3.5.5.2.

Recommended value:

For at least 5 seconds following the failure, the change in pitch force shall not exceed 20 pounds. While 20 lb. is within the capability of all pilots, a lower value may better accommodate females.

The requirement is intended to insure that the short-term response of the aircraft to a flight control system failure does not get out of hand before the pilot can react, and that a large effort is not required of the pilot. The requirements of 4.2.6.1 describe allowable transient responses. However, it is felt to be necessary also to have limits on the control forces required to minimize these responses. The flight control system includes any stability and control augmentation, as well as manual and automatic control and trim functions.

REQUIREMENT LESSONS LEARNED

5.2.8.6.5 Pitch axis control force limits--failures-verification.

Verification shall be by analysis, simulation and flight test.

VERIFICATION RATIONALE (5.2.8.6.5)

It may be necessary to provide special means of introducing failures for flight testing.

VERIFICATION GUIDANCE

Testing of failure modes--in flight or simulation--should always include consideration of demands on the pilot to retrim manually. This requirement supplements testing required by 4.2.6.1 and should be designed so that the control force requirements are also evaluated.

VERIFICATION LESSONS LEARNED

MIL-STD-1797A
APPENDIX A

4.2.8.6.6 Pitch axis control force limits--control mode change.

Without retrimming, the control force changes resulting from intentional engagement or disengagement of any portion of the primary flight control system by the pilot shall not exceed the following limits:

_____.

REQUIREMENT RATIONALE (4.2.8.6.6)

Intentional engagement or disengagement of any portion of the flight control system should never result in unusual or unreasonable demands on the pilot to retain control.

REQUIREMENT GUIDANCE

The related requirement of MIL-F-8785C is paragraph 3.5.6.2.

Recommended value:

For at least 5 seconds following the mode change, the change in pitch force shall not exceed 20 pounds.

Trim transients following intentional pilot actions with the flight control system should obviously be small.

Since this requirement deals with intentional modification of the flight control system, it is implied that no failures have occurred. Failures are covered explicitly by 4.2.8.6.5.

Proper application of this requirement may be performed by careful design of the aircraft augmentation systems. Mode switching should assure that the new mode chosen does not have any large transients in initialization.

REQUIREMENT LESSONS LEARNED

5.2.8.6.6 Pitch axis control force limits--control mode change -verification.

Verification shall be by analysis, simulation and flight test.

VERIFICATION RATIONALE (5.2.8.6.6)

Eventually, the production hardware and software should be flight tested.

VERIFICATION GUIDANCE

This requirement is effectively a subset of 4.2.6.2. Simulation, analysis, or flight test demonstrations for that paragraph should include force response tests.

VERIFICATION LESSONS LEARNED

4.2.8.7 Pitch axis trim systems.

In straight flight, throughout the Operational Flight Envelope the trimming system shall be capable of reducing the steady-state control forces to _____. Pitch trim systems shall not defeat other features incorporated in the flight control system that prevent or suppress departure from controlled flight or exceedance of structural limits, or that provide force cues which warn of approach to flight limits. The failures to be considered in applying Level 2 and 3 requirements shall include trim sticking and runaway in either direction. It is permissible to meet Level 2 and 3 requirements by providing the pilot with alternate trim mechanisms or override capability.

REQUIREMENT RATIONALE(4.2.8.7)

To ease pilot workload, it is necessary to specify the ability of the pitch trim to reduce control forces in operational flight, and in the event of trim system failures or flight control failures affecting other control surfaces. This paragraph is included to insure adequate trim system operation.

Some aircraft have features in the flight control system that are incorporated to prevent g overstress or departure, or provide force cues that aircraft limits are being reached. The use or misuse of the trim system should not degrade the protection afforded by these features.

REQUIREMENT GUIDANCE

The related MIL-F-8785C requirement is paragraph 3.6.1.

Recommended force limits:

Level 1 or 2:	Zero
Level 3:	No greater than 20 pounds, push or pull

The purpose of a trim system is to reduce steady-state forces on cockpit controls, preferably to zero. Transient forces are similarly limited by 4.2.8.6.5. The Operational Flight Envelopes cover the design missions, and so delineate the minimum requirement. It would be desirable, however, to have trim capability throughout the larger Service Flight Envelope and perhaps even to the maximum permissible speed. Straight flight includes climbs and dives.

In normal operations, this requirement is very straightforward. If a pitch trim is provided, it must be effective. However, the more quick or powerful a trim, the more catastrophic a trim failure can be. The difficulty in designing a trim system will be in assuring that extreme failures (trim hardover, sticking, etc.) are capable of being overcome by the pilot. Hence override or alternate trim mechanisms (e.g., dual trim systems) can be of prime importance.

REQUIREMENT LESSONS LEARNED

Operational experience with early electrical trim systems running away included crashes not only due to loss or inadequacy of control, but also due to excessive pilot fatigue from having to hold high forces for an extended time until a landing could be made.

Load factor or angle-of-attack limiting systems are often provided for relaxed static stability application. In some of these systems, however, trim system inputs are made downstream of the output from the primary system control laws. The result is that load-factor or angle-of-attack limiting systems can be defeated by use of trim. In some cases, it has been found that autopilot inputs through the trim system can also defeat these angle-of-attack limiting systems. A similar problem may exist in yaw for aircraft with sideslip limiters.

MIL-STD-1797A
APPENDIX A

5.2.8.7 Pitch axis trim systems-verification.

Verification shall be by analysis, simulation and flight test.

VERIFICATION RATIONALE (5.2.8.7)

Trim capability must eventually be shown through flight testing at conditions covering the range of operational flight.

VERIFICATION GUIDANCE

Flight conditions should be chosen to explore the boundaries of trim authority, e.g., low altitude and high speed (high dynamic pressure), and high altitude and low speed (low dynamic pressure) at most forward and most aft c.g. Inducing failures at these conditions may be impractical or judged too dangerous for flight. In this case, compliance with the failure requirement may be demonstrated by intentionally mistrimming the aircraft and recovering from the mistrim, or by simulation. The conditions which are the most critical will depend on the control feel.

VERIFICATION LESSONS LEARNED

4.2.9 Pitch axis control displacements

4.2.9.1 Pitch axis control displacements -- takeoff.

With the trim setting optional but fixed, the pitch-control travel during all types of takeoffs for which the aircraft is designed shall not exceed _____ percent of the total travel, stop-to-stop. Here the term takeoff includes ground run, rotation and lift-off, the ensuing acceleration to $V_{\max}(\text{TO})$, and any transient caused by assist cessation. Takeoff power shall be maintained until $V_{\max}(\text{TO})$ is reached, with the landing gear and high-lift devices retracted in the normal manner at speeds from $V_{\min}(\text{TO})$ to $V_{\max}(\text{TO})$. Satisfactory takeoffs including catapult takeoffs where applicable shall not depend upon use of the trim controller during takeoff or upon complicated control manipulation by the pilot.

REQUIREMENT RATIONALE(4.2.9.1)

This requirement insures that an excessive amount of cockpit-control movement does not add to the pilot's workload during this critical period. It also serves to help assure that there is reserve pitch control power during takeoff to allow regulation against gusts or pilot abuses.

REQUIREMENT GUIDANCE

The related MIL-F-8785C paragraph is 3.2.3.3.2.

The recommended maximum pitch control displacement is 75 percent of total travel for all controller types.

This requirement insures that under no condition will it be necessary to use the full range of nose-up and nose-down control to meet the operational takeoff performance requirements. An obvious motivation for this is to provide adequate control margin during takeoff for regulation against external disturbances or abuses of the aircraft. It should be noted that the use of full nose-up pitch control during the early phases of the takeoff roll is usually necessary to raise the nosewheel on soft fields. For conventional center stick or control column, having to reverse control travel fully would demand additional concentration at a time when assuring safety requires full pilot attention.

REQUIREMENT LESSONS LEARNED

The T-46 main gear location with respect to the c.g. results in an over rotation tendency at nose-wheel lift-off, while moving the main gear aft would require more pitch control power. At forward c.g., the pilot must push forward a great deal in order to avoid a tail strike.

5.2.9 Pitch axis control displacements-verification

5.2.9.1 Pitch axis control displacements--takeoff-verification.

Verification shall be by analysis, simulation and flight test.

VERIFICATION RATIONALE (5.2.9.1)

See Rationale for 5.2.8.6.1.

VERIFICATION GUIDANCE

Forward c.g. is critical for initiating the takeoff attitude, while aft c.g. will accentuate any overrotation tendency that requires control reversal. Control effectiveness varies directly with dynamic pressure, so that effectiveness is minimum at low gross weight (low takeoff speed) and maximum at high gross weight.

MIL-STD-1797A
APPENDIX A

Because of the well-recognized problems in modeling aerodynamics in ground effect, simulation results generally will not be adequate for demonstrating compliance with this requirement. Flight testing performed to demonstrate compliance with 4.2.8.6.1 should include measurement of control displacements.

VERIFICATION LESSONS LEARNED

MIL-STD-1797A
APPENDIX A

4.2.9.2 Pitch axis control displacements--maneuvering.

For all types of pitch controllers, the control motions in maneuvering flight shall not be so large or so small as to be objectionable. In steady turning flight and in pullups at constant speed, the incremental control deflection required to maintain a change in normal load factor and pitch rate shall be in the same sense (aft--more positive, forward--more negative) as those required to initiate the change.

REQUIREMENT RATIONALE(4.2.9.2)

There is evidence that stick deflection characteristics, while secondary to force characteristics, are still important to the pilot when maneuvering.

REQUIREMENT GUIDANCE

The related MIL-F-8785C requirements are paragraphs 3.2.2.2 and 3.2.2.2.2.

For maneuvering flight it is necessary that control motions and displacements be comfortable and natural to the pilot. In this regard, the above requirements are intended to assure that control motion and aircraft motion are in harmony, with positive maneuvering stability throughout the Service Flight Envelope. Controller force/deflection characteristics are specified in 4.2.8.4.

Proper design of the pitch control power (4.2.7) and forces (4.2.8) for maneuvering should result in the above requirements being met. However, these requirements function as final tests of the adequacy of the controller specified by 4.2.7 and 4.2.8.

A simple, conventional control system requires more control deflection per g at low speed than at high speed, even though stick force per g remains fairly constant. The change in deflection gradient is a useful cue to airspeed, one of the few available cues in maneuvering with head out of cockpit.

REQUIREMENT LESSONS LEARNED

The isometric sidarm controller used in the YF-16 and early F-16 was unsatisfactory to many pilots (see AFFTC-TR-75-15 and AFFTC-TR-79-10). Their primary objection was the lack of tactile cues as to when the controller was at its limit. A small amount of motion, as permitted by the cockpit contours, was incorporated into the controller that has been adopted.

The X-29 got limit load factor at all speeds with full aft stick. Combined with sensitive roll control, this resulted in poor control harmony at all speeds.

5.2.9.2 Pitch axis control displacements--maneuvering-verification.

Verification shall be by analysis, simulation and flight test.

VERIFICATION RATIONALE(5.2.9.2)

Control displacements will be measured and assessed in verification of 4.2.7.2 and 4.2.8.1.

VERIFICATION GUIDANCE

Flight testing (5.2.7.2) should provide proof of compliance with these requirements, at the most forward and most aft c.g., over the load factor range of the Service Flight Envelope. The subjective requirement for control motions to be not objectionable may also be interpreted as "not cause a degradation in flying quality Level". For example, control motions alone should not degrade a Level 1 aircraft to Level 2.

VERIFICATION LESSONS LEARNED

4.3 Flying quality requirements for normal (flight path) axis

Conventionally, normal acceleration is controlled through the pitch controller. Additional requirements that concern normal-acceleration response will be found with the pitch-axis requirements:

4.2.1.2 Short-term pitch response [$\omega_{sp}^2 / (n/\alpha)$]

4.2.2 Pilot-induced pitch oscillations

4.2.3 Residual pitch oscillations

4.2.4 Normal acceleration at the pilot station

4.2.6 Pitch axis response to other inputs

4.2.6.1 Pitch axis response to failures, controls free

4.2.6.2 Pitch axis response to configuration or control mode change

4.2.7.2 Pitch axis control power in maneuvering flight

4.2.7.2.1 Load factor response

4.2.8.1 Pitch axis control forces--steady-state control force per g

4.2.8.2 Pitch axis control forces--transient control force per g

4.2.8.3 Pitch axis control forces--control force variations during rapid speed changes.

4.3.1 Flight path response to attitude change

4.3.1.1 Transient flight path response to attitude change.

The relation of the flight path response to pitch attitude, for pilot control inputs, shall be as follows:

- a. The short-term flight path response to attitude changes shall have the following characteristics: _____
- b. If a designated controller other than attitude is the primary means of controlling flight path, the flight path response to an attitude change can be degraded to the following: _____
- c. In all cases, the pitch attitude response must lead the flight path angle by _____, and must have a magnitude equal to or greater than the flight path angle.

REQUIREMENT RATIONALE(4.3.1.1)

This requirement is included to provide a separate and independent criterion for flight path response to pitch attitude changes. Different criteria are necessary for conventional aircraft (for which pitch attitude is the primary means for flight path control) and for STOL aircraft (for which pitch attitude plays a secondary, role in path control or is used only to control speed).

REQUIREMENT GUIDANCE

There is no related MIL-F-8785C requirement.

Recommended values: Insufficient data available.

1. Frontside Operation

Aircraft operating on the front side of the power-required curve are capable of flight-path control via control of pitch attitude. In fact, the primary motivation for the limits set in 4.2.1.2 is to provide the required inner loop which will allow aggressive precision outer-loop (path) tracking characteristics. A block diagram depicting the pilot/vehicle loop structure for this situation is shown in figure 19. As shown in that block diagram, the short-term flight path response is related kinematically to the aircraft pitch attitude change by the ratio of numerators of the open-loop transfer functions (using $1/T_{\theta_2}$ of the basic aircraft, $\approx -Z_w$):

$$\frac{\gamma}{\theta} = \frac{N_{\delta}^{\gamma}}{N_{\delta}^{\theta}} \doteq \frac{1}{T_{\theta_2} s + 1}$$

No feedbacks to a single control surface can alter this ratio in form or dynamics. The long-term response is related to $d\gamma/dV$, which of course depends on the position of the operating point on the power-required curve (see 4.3.1.2).

The equivalent-system requirements for pitch attitude control (see 4.2.1.2) involve equivalent $1/T_{\theta_2}$ directly ($\omega_{sp} T_{\theta_2}$ limits) or indirectly [ω_{sp} vs. n/α where $n/\alpha \doteq (V/g) (1/T_{\theta_2})$]. Hence these requirements appear to involve pitch and path control in a single criterion. However, because the experimental data used to develop correlations for the criteria do not contain sufficient independent variation of speed and $1/T_{\theta_2}$ (primarily NT-33 data), it is not possible to determine unequivocally whether the boundaries do indeed account for path as well as pitch. The lack of sufficient data also makes it impossible to establish a quantitative requirement for this paragraph. However, for design guidance for

MIL-STD-1797A
APPENDIX A

Category C Flight Phases, the actual $1/T_{\theta_2}$ as well as its equivalent-system value should be at least greater than the minimum values specified in figure 24.

The bandwidth criterion of 4.2.1.2 clearly is a specification on attitude control only and therefore requires a separate specification on short-term path response, i.e., minimum value of $1/T_{\theta_2}$. Again the values specified in figure 24 provide reasonable guidance for Category C. These limiting values are repeated in table XXII for reference. The values of $(1/T_{\theta_2})_{\min}$ in table XXII are simply the lower boundaries on n/α tabulated in figure 24, which are for an approach speed of 135 kt. Generally speaking, $1/T_{\theta_2}$ is large enough to be of no concern for CTOL aircraft in Category A and B flight phases, and hence no data are available to establish lower limits.

TABLE XXII. Guidance for lower limit on $1/T_{\theta_2}$.

LEVEL	CLASS	$(1/T_{\theta_2})_{\min}$
1	I, II-C, IV	0.38
	II-L, III	0.28
2	I, II-C, IV	0.24
	II-L, III	0.14

2. Backside Operation

An aircraft operating well on the back side of the power-required curve (dy/dV positive) must rely on thrust or thrust vectoring for path control. Such STOL aircraft without autothrottle usually have sufficiently fast engine response characteristics (or some type of blended DLC) that allow precision flight path tracking with the throttles (or other designated flight path controller). Pitch attitude is then used to control airspeed, which varies only slowly. The control of pitch attitude becomes much less critical and hence some relaxation in the Level 1 limits should be allowed. One object of current STOL flying qualities work is to provide an estimate of the allowable relaxation in the attitude criterion as a function of the quality of the short-term flight path response to throttle (or designated flight path controller). Such a control technique obviously requires special pilot training.

3. Attitude/Path Consonance

Experience has shown that the path response bandwidth should be well separated from the pitch response bandwidth. Evidence to support this result is given in the analysis and flight test results obtained by DFVLR (using an HFB-320 in-flight simulator) and reported by Hanke et al. in AGARD-CP-333. These results indicate that an appropriate criterion parameter would be the phase angle between path and attitude at the short-period frequency, i.e.,

$$\phi(\gamma/\theta)_{\omega=\omega_{sp}}$$

Noting that the phase angle $\phi(\gamma/\theta)$ evaluated at $\omega = \omega_{sp}$ is given by $\tan^{-1}(\omega_{sp} T_{\theta_2})$, the criterion of 4.2.1.2 on equivalent $\omega_{sp} T_{\theta_2}$ can be easily converted to $\phi(\gamma/\theta)_{\omega=\omega_{sp}}$, with the results shown in table

MIL-STD-1797A
APPENDIX A

XXIII. The advantage of using $\phi(\gamma/\theta)_{\omega=\omega_{sp}}$ is that it does not require a LOES fit to identify ω_{sp} and $1/T_{\theta_2}$ when the bandwidth criterion is utilized. It should be recognized that the values in table XXIII are based on the same NT-33 flight test data as the LOES boundaries in 4.2.1.2. Until more data can be obtained to indicate pilot rating trends and $1/T_{\theta_2}$ is varied at constant ω_{sp} , it is felt that table XXIII should be kept in the category of guidance.

TABLE XXIII. Conversion of $\omega_{sp} T_{\theta_2}$ to a phase angle criterion.

CATEGORY	LEVEL	$(\omega_{sp} T_{\theta_2})_{min}$	ALLOWABLE $\phi(\gamma/\theta)_{\omega=\omega_{sp}}$ (deg)
A	1	1.6	-58
	2	1.0	-45
B	1	1.0	-45
	2	1.0	-45
C	1	1.3	-52
	2	1.0	-45

Notice that $\omega_{sp} T_{\theta_2} = 1$ means that $\omega_{sp} = 1/T_{\theta_2}$, that is, there is no frequency separation between these two roots; a γ/θ phase angle less than 45 deg at ω_{sp} means that $1/T_{\theta_2} > \omega_{sp}$, that is, a high-frequency γ/θ response.

Low $1/T_{\theta_2}$ with respect to ω_{sp} results in a large pitch-rate overshoot or, looked at another way, a large lag in the response of γ to θ . A number of writers, including Gibson in AGARD-CP-333, have commented on the need to avoid these excesses, too.

REQUIREMENT LESSONS LEARNED

Recent ground-based and in-flight simulations have indicated that (a) with attitude hold, the inner pitch loop and $1/T_{\theta_2}$ are not so important and (b) too much direct lift control blended with the pitch controller may actually be harmful. See the 4.2.1.2 guidance.

5.3 Flying qualities requirements for the normal (flight path) axis-verification

5.3.1 Flight path response to attitude change-verification

5.3.1.1 Transient flight path response to attitude change-verification.

Verification shall be by analysis, simulation and flight test.

VERIFICATION RATIONALE (5.3.1.1)

Verification will involve frequency-response measurements.

MIL-STD-1797A
APPENDIX A

VERIFICATION GUIDANCE

For a basic conventional aircraft,

$$\begin{aligned} \frac{1}{T_{\theta 2}} &\approx \frac{\rho g V}{2W/s} (C_{L\alpha} + C_D) (1 + C_{m\alpha} C_{L\delta} / C_{m\delta}) \\ &\approx \frac{\rho g V}{2W/s} C_{L\alpha} \approx \frac{g}{V} \cdot \frac{C_{L\alpha}}{C_{L1}} \approx \frac{g}{V} \cdot \frac{n}{\alpha} \end{aligned}$$

That gives the limit bandwidth of outer-loop flight path control when an inner pitch attitude loop is closed, for any flight control system mechanization utilizing a single control surface. The natural aircraft's short-term flight path response is at a natural frequency of

$$\omega_{sp} \approx \sqrt{gh_m / (C_{L1} k_y^2 \bar{c})}$$

(see 5.2.1.2 discussion); at that frequency the path lags the attitude by a phase angle $\tan^{-1}(\omega_{sp} T_{\theta 2})$.

VERIFICATION LESSONS LEARNED

MIL-STD-1797A
APPENDIX A

4.3.1.2 Steady-state flight path response to attitude change.

For flight path control primarily through the pitch attitude controller, the steady-state path and airspeed response to attitude inputs shall be as follows: _____. For flight control modes using another designated flight path control the required flight path response to attitude changes is _____.

REQUIREMENT RATIONALE (4.3.1.2)

The accepted piloting technique for conventional flight is to adjust flightpath via pitch attitude control. This requirement is included to insure that the long-term flight path response to pitch attitude changes is acceptable to the pilot.

For aircraft using another specified flight path controller for primary control of flight path, a relaxation is warranted when use of such a piloting technique is deemed acceptable. Examples might be some shipboard and STOL operations. In those cases the pilots must be trained appropriately.

REQUIREMENT GUIDANCE

The related MIL-F-8785C requirements are paragraphs 3.2.1.3 and 3.6.2.

For most conventional aircraft the first part of this requirement is applicable, and guidance is given herein. For such aircraft as STOLs in which primary control of flight path is not with pitch attitude, a relaxation of 4.3.1.2 (that is, to allow operation well on the back side of the thrust-required vs. airspeed curve) should be allowed. Although no guidance is presently available, current STOL flying qualities research addresses requirements such as this.

Recommended values:

Flight-path stability is defined in terms of flight-path-angle change with airspeed when regulated by use of the pitch controller only (throttle setting not changed by the crew). For the landing approach Flight Phase, the curve of flight-path angle versus true airspeed shall have a local slope at $V_{o\ min}$ that is negative or less positive than:

Level 1: 0.06 degrees/knot

Level 2: 0.15 degrees/knot

Level 3: 0.24 degrees/knot

The thrust setting shall be that required for the normal approach glide path at $V_{o\ min}$. The slope of the curve of flight-path angle versus airspeed at 5 knots slower than $V_{o\ min}$ shall not be more than 0.05 degrees per knot more positive than the slope at $V_{o\ min}$ as illustrated by the sketch.

MIL-STD-1797A
APPENDIX A

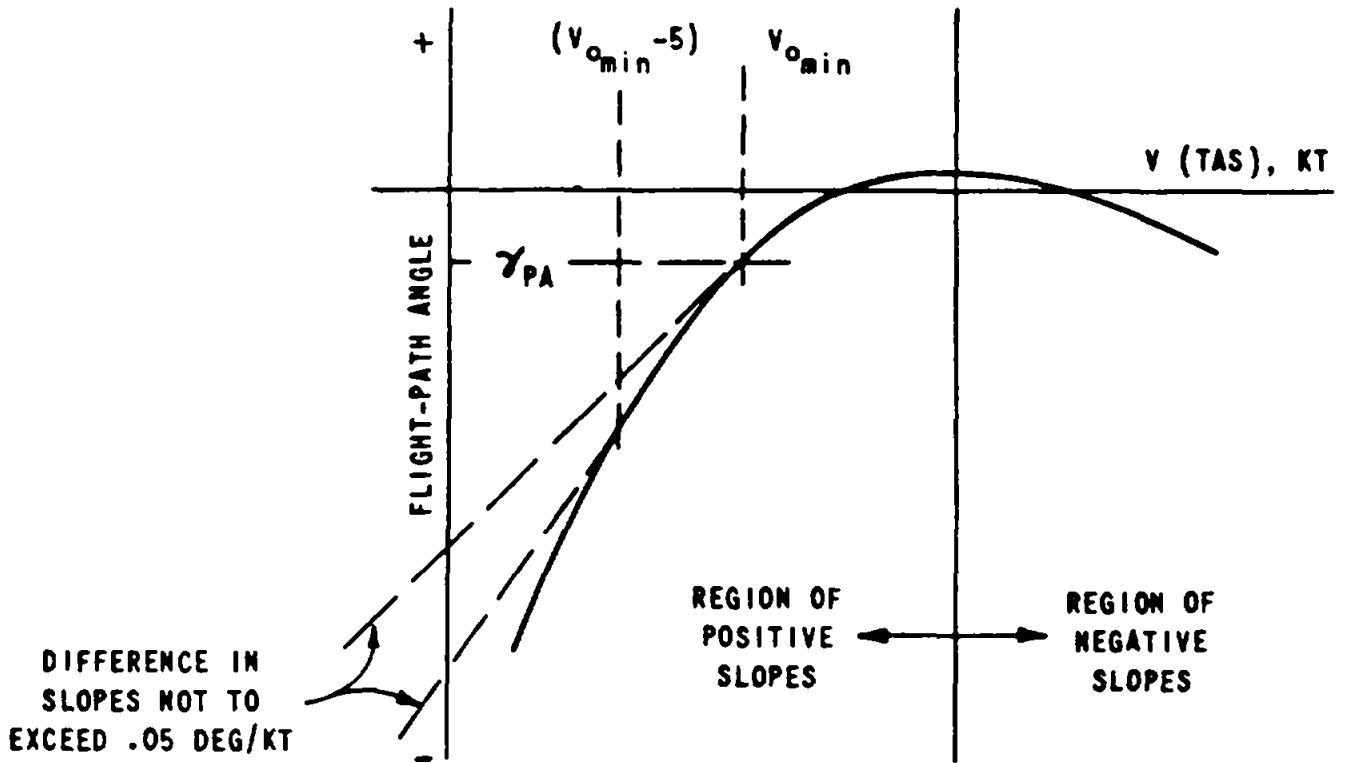

Discussions for this section, including the supporting data, are taken from AFFDL-TR-69-72.

Operation on the backside of the drag curve [negative $d(T - D)/dV$] in the landing approach leads to problems in airspeed and flight-path control. Systems Technology Inc. TR-24-1, AGARD Rpt 122, RAE Aero. 2504, and AGARD Rpt 357 show that airspeed behavior, when elevator is used to control attitude and altitude, is characterized by a first-order root that becomes unstable at speeds below minimum drag speed. This closed-loop, constrained-flight path instability, even when the open-loop (unattended aircraft) phugoid motion is stable, is caused by an unstable zero in the h/δ_e aircraft transfer function. Specifically, Systems Technology Inc. TR-24-1 uses closed-loop analyses to show the importance of the factor $1/T_{h1}$ as an indicator of closed-loop system stability and throttle activity required. A useful measure of the quantity $1/T_{h1}$ is needed.

Working from the altitude-to-elevator transfer function, FDL-TDR-64-60 shows that $1/T_{h1}$ is closely approximated (the other two zeros generally are much larger) by the ratio D/C , where D and C are from the expression:

$$\frac{\dot{h}(s)}{\delta_e(s)} = \frac{As^3 + Bs^2 + Cs + D}{[s^2 + 2\zeta_p\omega_p s + \omega_p^2][s^2 + 2\zeta_{sp}\omega_{sp} s + \omega_{sp}^2]}$$

The additional assumption that C is approximately equal to $V(Z_{\delta_e} M_w - M_{\delta_e} Z_w)$ is generally valid, so that (WADC-TR-58-82):

$$\frac{1}{T_{h1}} = \frac{D}{V(Z_{\delta_e} M_w - M_{\delta_e} Z_w)}$$

The climb angle γ is \dot{h}/V . Applying the limit value theorem to $\gamma(s)/\delta_e(s)$, for a step δ_e [$\delta_e(s) = |\delta_e|/s$] then

MIL-STD-1797A
APPENDIX A

$$\frac{d\gamma}{d\delta_e} = \frac{\gamma(s)}{\delta_e(s)} \Big|_{SS} = \frac{1}{V} \cdot \frac{D}{\omega_p^2 \omega_{sp}^2}$$

In a similar manner, the slope of the steady-state u versus δ_e curve is obtained.

$$\frac{du}{d\delta_e} = \frac{u(s)}{\delta_e(s)} = - \frac{g(Z_{\delta_e} M_w - M_{\delta_e} Z_w)}{\omega_p^2 \omega_{sp}^2}$$

Then the slope of the steady-state γ versus u curve for elevator inputs can be written

$$\begin{aligned} \frac{d\gamma}{d\delta_e} &= \frac{d\gamma/d\delta_e}{du/d\delta_e} = - \frac{1}{g} \cdot \frac{D}{V(Z_{\delta_e} M_w - M_{\delta_e} Z_w)} \\ &= - \frac{1}{g} \cdot \frac{1}{T_{h1}} \end{aligned}$$

The $d\gamma/du$ limits, therefore, set limits on $1/T_{h1}$.

The limit on $d\gamma/du$ at 5 knots slower than $V_{o \min}$ was added to assure that the aircraft remains tractable at commonly encountered off-nominal speeds.

For design purposes, $d\gamma/du$ can be estimated from the dimensional stability derivatives (which must include any important thrust effects) as follows:

$$\frac{d\gamma}{du} = \frac{1}{g} \left[X_u - \left(X_w - \frac{g}{V} \right) \left(\frac{Z_u - M_u Z_{\delta_e} / M_{\delta_e}}{Z_w - M_w Z_{\delta_e} / M_{\delta_e}} \right) - \frac{X_{\delta_e}}{M_{\delta_e}} \left(\frac{M_w Z_u - Z_w M_u}{-Z_w + M_w Z_{\delta_e} / M_{\delta_e}} \right) \right]$$

or

$$\frac{d\gamma}{du} = \frac{1}{g} \left[X_u - \left(X_w - \frac{g}{V} \right) \left(\frac{Z_u - M_u Z_{\delta_e} / M_{\delta_e}}{1/T_{\theta 2}} \right) - \frac{X_{\delta_e}}{M_{\delta_e}} \cdot \frac{\omega_p^2 \cdot \omega_{sp}^2}{g(1/T_{\theta 2})} \right]$$

For M_u and X_{δ_e} small, the following approximation is valid except for very-short-tailed aircraft:

$$\frac{d\gamma}{du} \doteq \frac{1}{g} \left[X_u - \left(X_w - \frac{g}{V} \right) \frac{Z_u}{Z_w} \right]$$

It is possible to violate this requirement by operating well on the back side of the power-required curve ($d\gamma/du > 0$) and still have a Level 1 aircraft as long as some other means of controlling flight path is provided (usually power or thrust). Naturally this other controller must have satisfactory characteristics. For example if the throttle is designated as the flightpath controller, good dynamic and steady-state flight path response to throttle changes (γ/δ_T) must be assured. Although there are no quantitative data to support this, it seems logical that progressively degraded γ/θ can be compensated with incremental improvements in $(\gamma/\delta_T)_{SS}$. Examples of aircraft that have poor $(\gamma/\theta)_{SS}$ characteristics but are acceptable because flight path control is augmented with thrust are the de Havilland Twin Otter, the DHC-7, and many carrier-based fighters (e.g., Systems Technology Inc. TR-124-1). But Pinsker (RAE-TR-71021) found that an autothrottle to hold constant airspeed can be quite destabilizing if the thrust line passes below the c.g. of a statically stable aircraft. Requirements on γ/δ_T are specified in 4.3.2 based on STOL aircraft research.

MIL-STD-1797A
APPENDIX A

Since backside operation (defined as having $d\gamma/du > 0$) is most critical during landing approach, this requirement is oriented toward that Flight Phase. To improve $d\gamma/du$ requires increasing the airspeed, which has obvious performance implications. Backside operation is also troublesome for takeoff, cruise, and high-altitude maneuvering, but it will probably not be as critical as for the landing approach, and there are virtually no data to define numerical limits for these Flight Phases.

In the event the aircraft is operated with a continuous flight path controller (e.g. DLC on the YC-15), which serves (one hopes) to improve the flight path response, allowing the relaxation for aircraft with designated flight path controller should be considered.

SUPPORTING DATA

The $1/T_{h_1}$ data used to set numerical limits on $d\gamma/du$ are given in AFFDL-TR-66-2, NASA-TN-D-2251, AGARD Rpt 420, AFFDL-TR-65-227, and "Simulator and Analytical Studies of Fundamental Longitudinal Problems in Carrier Approach" as in the following discussion.

It is apparent from figures 125 - 127 (from AFFDL-TR-66-2) that pilot ratings of $1/T_{h_1}$ are dependent on the values of ζ_p . For Level 1, 4.2.1.2 requires $\zeta_p > 0.04$; greater damping might result from autothrottle or similar augmentation. Therefore, the positive ζ_p data of figure 125 were used to establish the Level 1 requirement for $1/T_{h_1}$ or $d\gamma/dV$. (The data from figures 126 - 128 are obviously too conservative for Level 1. The configurations for figure 126 had ω_{sp} marginally close to the lower Level 1 boundary; while those for figure 128 were downrated because of the pitch response to horizontal gusts caused by M_u .) For Levels 2 and 3, the zero- ζ_p data seem appropriate:

<u>Figure</u>	<u>Level 2</u>	<u>Level 3</u>
125	$1/T_{h_1} > -0.08$	$1/T_{h_1} > -0.12$
126	$1/T_{h_1} > -0.05$	$1/T_{h_1} > -0.08$

From figure 127, with near-zero ζ_p :

<u>Level 2</u>	<u>Level 3</u>
$1/T_{h_1} > -0.05$	$1/T_{h_1} > -0.12$

From figure 128, with high ζ_p but in turbulence:

<u>Level 2</u>	<u>Level 3</u>
$1/T_{h_1} > -0.05$	$1/T_{h_1} > -0.12$

MIL-STD-1797A
APPENDIX A

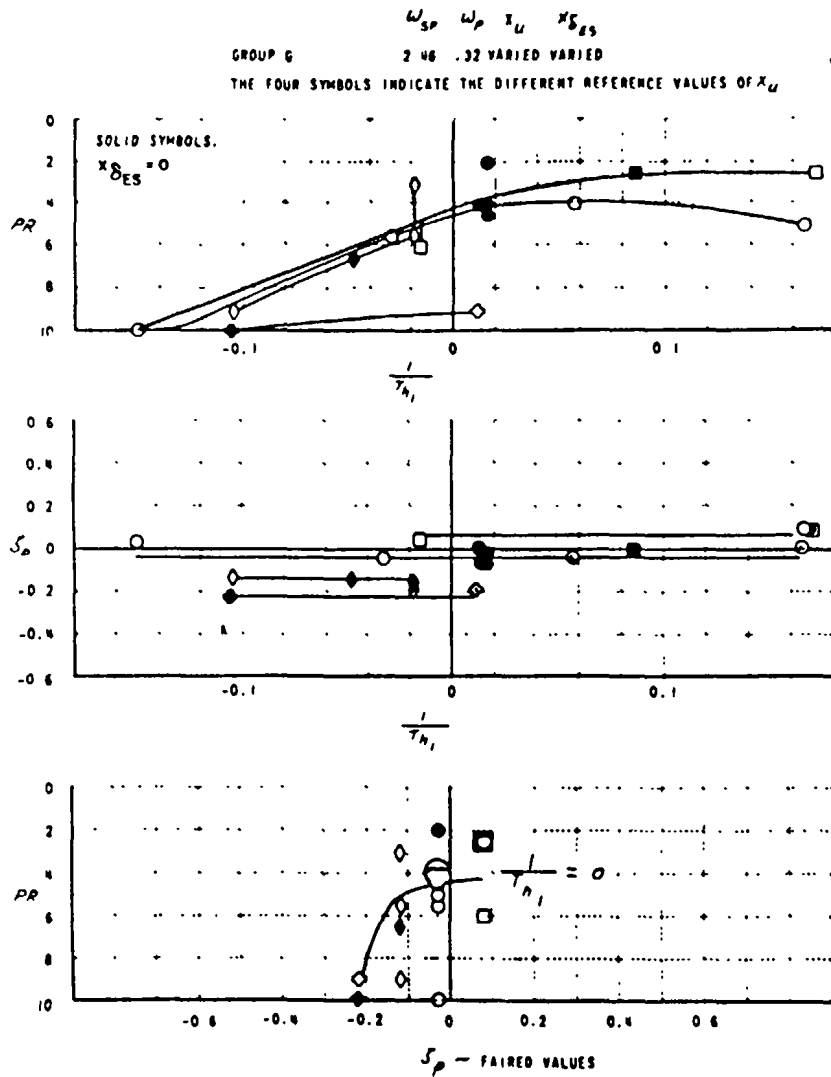

FIGURE 125. Landing approach (T-33, AFFDL-TR-66-2).

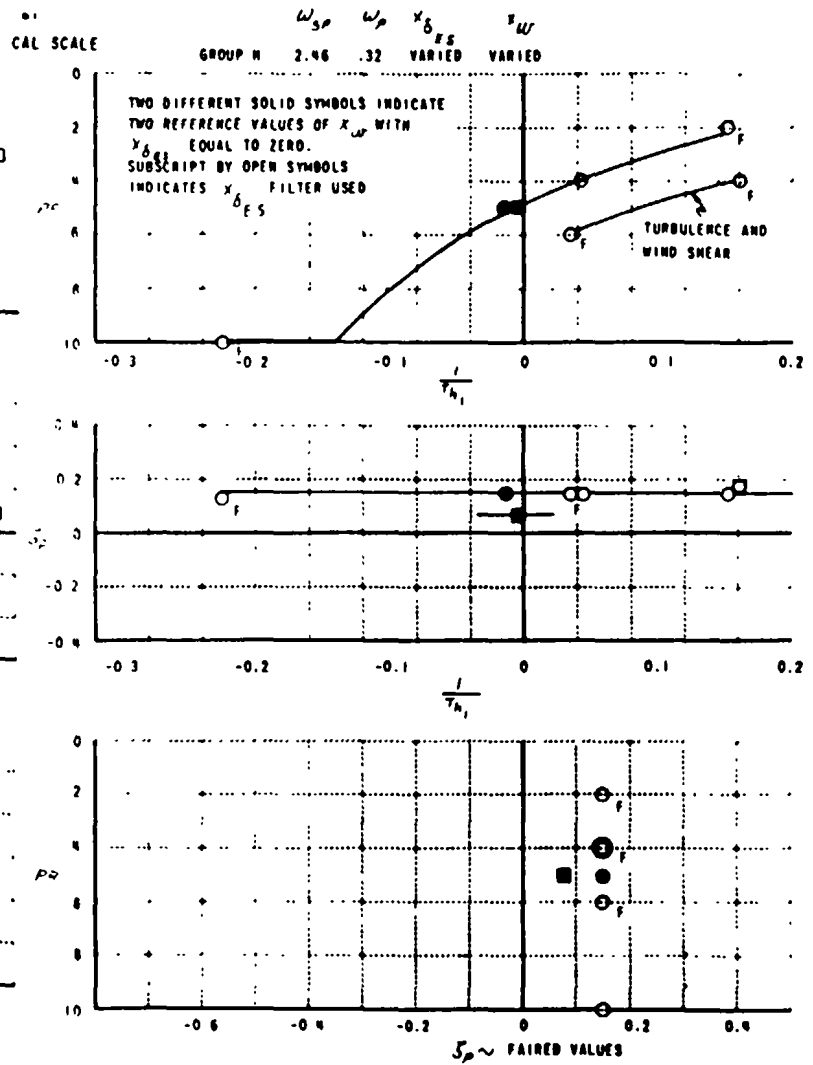

FIGURE 126. Landing approach (T-33, AFFDL-TR-66-2).

MIL-STD-1797A
APPENDIX A

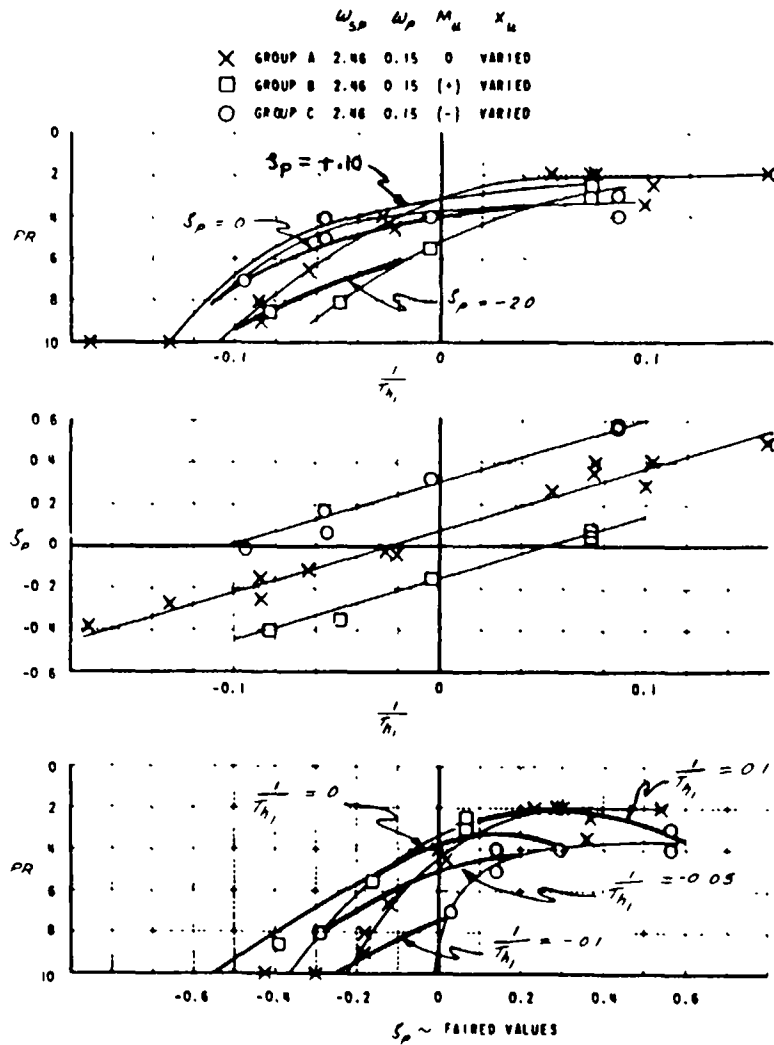

FIGURE 127. Landing approach (T-33, AFFDL-TR-66-2).

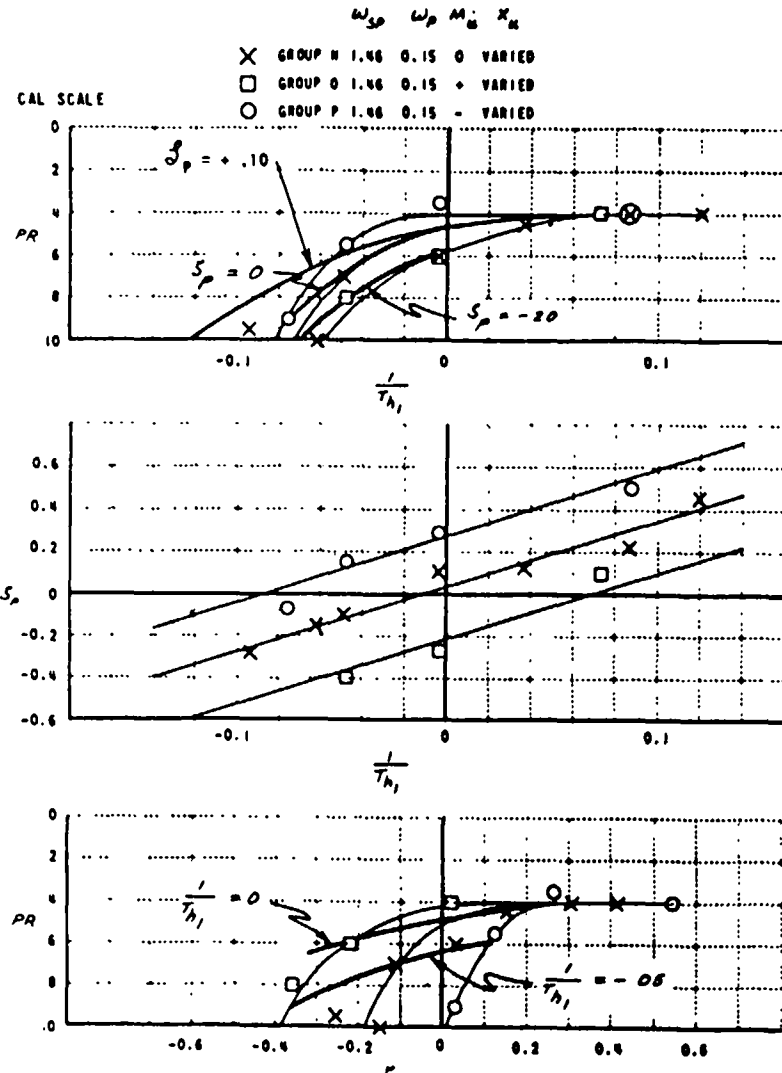

FIGURE 128. Landing approach (T-33, AFFDL-TR-66-2).

MIL-STD-1797A
APPENDIX A

Combinations of Level 2 or 3 values of $1/T_{h_1}$ with low ζ_p , ω_{sp} , or both appear worse than cases with high ζ_p and ω_{sp} . With these considerations in mind, $T_{h_1} = -0.02$ was chosen for the Level 1 boundary, -0.05 for Level 2, and -0.08 for Level 3. These values of $1/T_{h_1}$ correspond to the $d\gamma/dV$ values specified: multiply $1/T_{h_1}$ by $-(57.3)(1.689)/(32.2) = -3$.

The ground simulator experiment of "Simulator and Analytical Studies of Fundamental Longitudinal Control Problems in Carrier Approach" altered $1/T_{h_1}$ by changing X_w and X_{δ_e} and also considered the influences of thrust-line inclination and thrust-line offset on the flying qualities. There are very limited data for thrust-line offset, and the decision was made to assume that designers will take reasonable steps to keep the offset as small as possible. The data for zero thrust-line offset are presented in figure 129 for different values of thrust-line inclination. The data do seem to indicate that some thrust-line inclination is desirable, but the variations in rating due to inclination are well within the scatter of the data considered as a whole.

The data from ground simulator experiments of NASA-TN-D-2251 and AFFDL-TR-65-227 are presented in figure 130. It should be mentioned that only the data for the highest static margin in NASA-TN-D-2251 are presented because the lower static margins result in values of ω_{sp} that are too low for Level 1.

The data from the in-flight experiment of AGARD Rpt 420 are presented in figure 131. There are several factors that influence interpretation of this data. First, the pilot rating scale used is a modified version of the Cooper scale and is rather difficult to interpret. Second, the speed stability was changed by altering $\partial T/\partial V$ as well as a $\partial T/\partial \alpha$, which means that unstable values of speed stability were accompanied by negative values of phugoid damping. Since the speed stability was altered in this experiment by using engine thrust, the pilot could use the engine noise as an airspeed cue. The final (and probably most significant) factor is that most of the approaches were flown VFR, with a ground controller supplying continuous flight-path information by radio using a theodolite. AGARD Rpt 420 states that this type of technique resulted in very tight control of flight path. A few approaches were made using precision-approach radar, these were much more difficult for the pilot to successfully accomplish. The relationship between the speed stability parameter $1/T_2$ of figure 131 and $1/T_{h_1}$ is as follows:

$$1/T_{h_1} = 0.693 (1/T_2)$$

A comparison of the requirements derived from figures 125 through 128 and the data from figures 129 through 131 are presented in the following tabulation. Note that in figures 129 through 131, the pilot rating scale is the Cooper scale. The Levels are qualitatively equivalent to those of the Cooper-Harper scale, but their boundaries on the scale are different. On the Cooper scale the Level 1 boundary is at 3.5, the Level 2 boundary is at 5.5, and the Level 3 boundary is at 7 (see AFFDL-TR-69-72).

	Level 1	Level 2	Level 3
Requirement of 4.3.1.2	-0.02	-0.05	-0.08
Figure 129	-0.035	-0.084	-0.107
Figure 130	-0.020 to -0.035	-0.095	-1.121
Figure 130	-0.010	-	-
Figure 131 (no thrust lag)	+0.010	-0.190	-0.360
Figure 131 (thrust lag)	+0.017	-0.060	-0.125

The primary problem with figure 129 seems to be that the majority of the data points are for VFR approaches with unusually good flight-path information available to the pilot (see AGARD Rpt 420)

MIL-STD-1797A
APPENDIX A

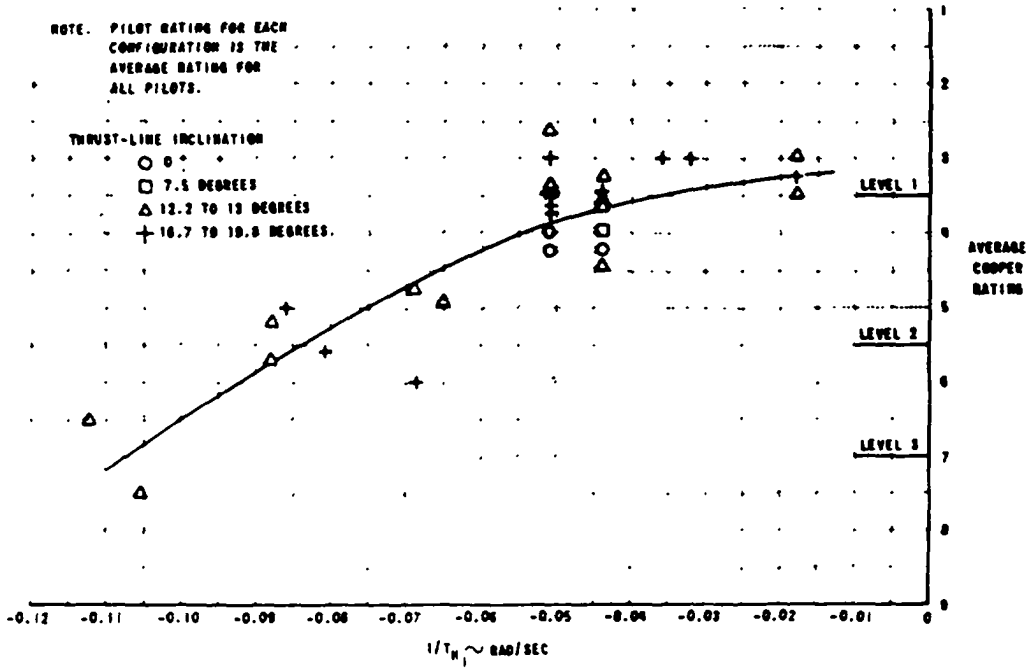

FIGURE 129. Carrier approach (Ground simulator experiment, "Simulator and Analytical Studies of Fundamental Longitudinal Control Problems in Carrier Approach").

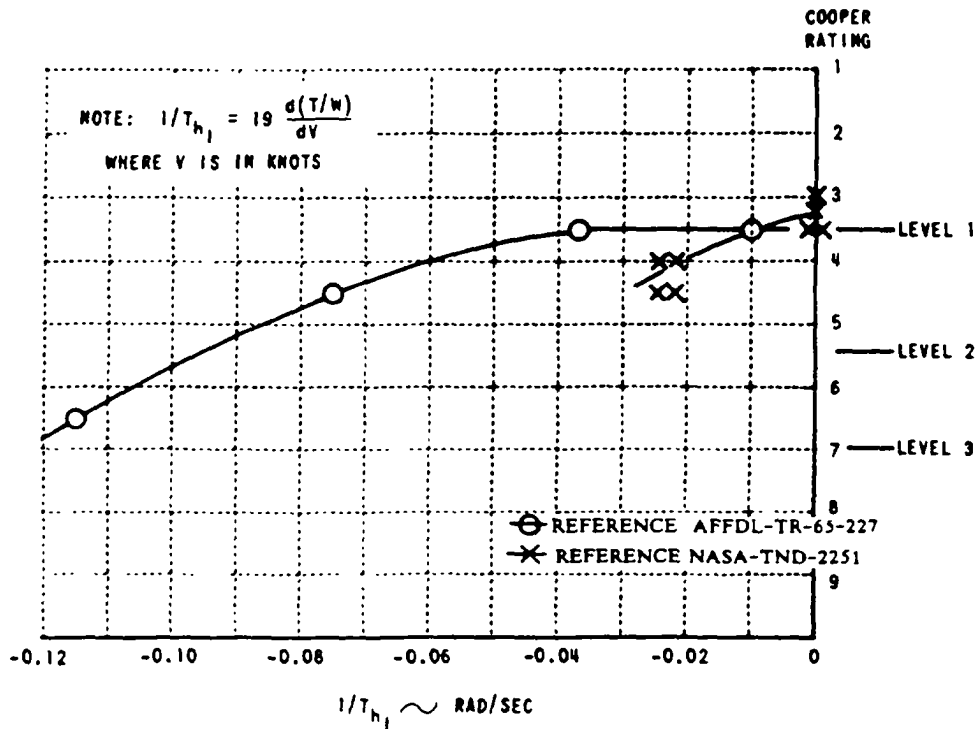
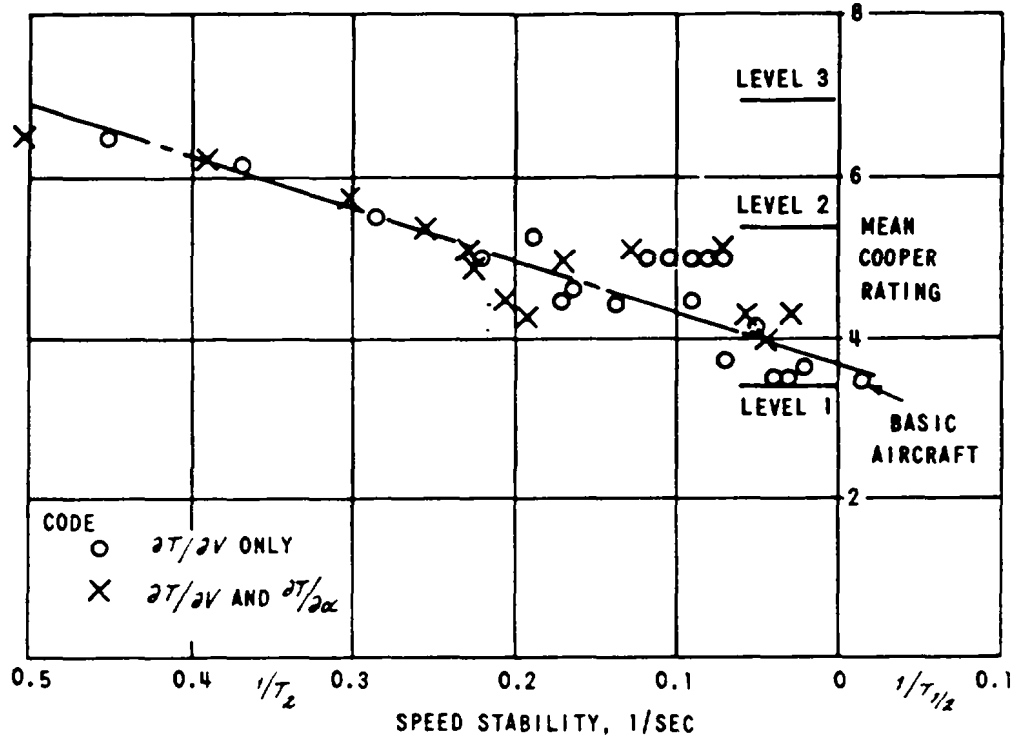
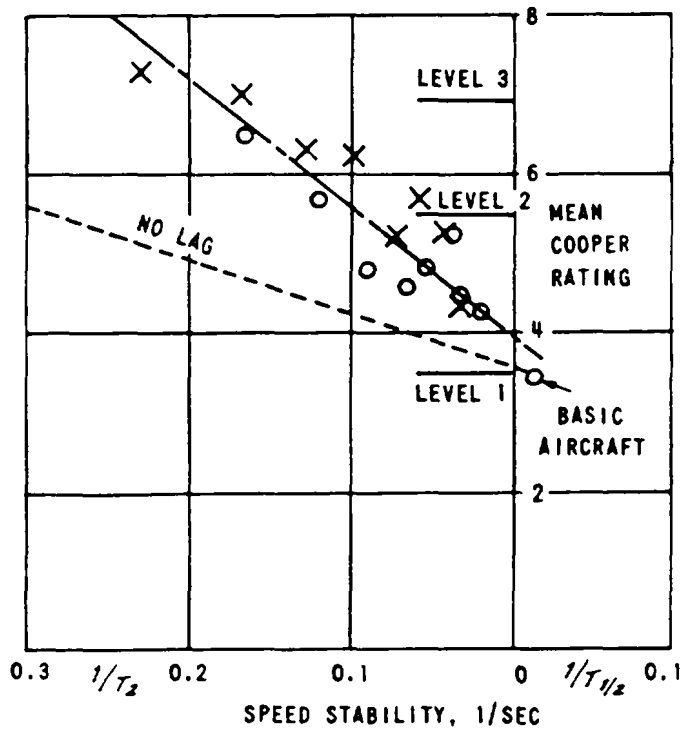

FIGURE 130. SST landing approach (Ground simulator experiments, NASA-TN-D-2251 and AFFDL-TR-65-227).

MIL-STD-1797A
APPENDIX A



(a) NO THRUST LAG



(b) WITH THRUST LAG

FIGURE 131. Landing approach (AVRO 707, AGARD Rpt 420).

MIL-STD-1797A
APPENDIX A

REQUIREMENT LESSONS LEARNED

There have been numerous aircraft judged unsatisfactory or even unacceptable because of backside characteristics. A recent case is the F-16, which had notable deficiencies (AFFTC-TR-79-10) in the landing approach flight condition. These deficiencies were specifically attributed to flight path instabilities. $d\gamma/dV$ at the approach angle of attack (13 deg) was 0.15 (Level 2). It was also noted that pitch attitude control was imprecise, which compounded the problem.

5.3.1.2 Steady-state flight path response to attitude change-verification.

Verification shall be by analysis, simulation, and flight test.

VERIFICATION RATIONALE (5.3.1.2)

The climb-angle-versus-airspeed data used to demonstrate compliance can be obtained during the stabilized-airspeed tests for static stability at low airspeeds.

By its nature, the climb angle to be measured is relative to the air, not the ground. When using Doppler radar or ground-based tracking equipment to obtain the data, the wind must be calm, or at least constant and accurately measured.

VERIFICATION GUIDANCE

In terms of nondimensional quantities, for small γ , neglecting $C_{D\delta}$, C_{D_u} , C_{L_u} , C_{m_u} , and $\partial T/\partial \alpha$,

$$\frac{d\gamma}{dV} \approx -\frac{2}{U_0} \left\{ \left[\left(\frac{T}{W} - \frac{V}{2} \frac{\partial(T/W)}{\partial u} \right) \cos(\alpha + i_t) - \gamma \right] \left[1 + \frac{\gamma_0 C_L/C_{N\alpha}}{1 - \frac{C_{L\delta} C_{m\alpha}}{C_{m\delta} C_{N\alpha}}} \right] - \frac{C_{L1}}{C_{N\alpha}} \left[\frac{\frac{T}{W} \sin(\alpha + i_t) + C_{D\alpha}/C_{L1}}{1 - \frac{C_{L\delta} C_{m\alpha}}{C_{m\delta} C_{N\alpha}}} \right] \left[1 + \left(\frac{z_t}{\bar{c}} \frac{C_{L\delta}}{C_{m\delta}} - \sin(\alpha + i_t) \right) \left(\frac{T}{W} - \frac{V}{2} \frac{\partial(T/W)}{\partial u} \right) \right] \right\}$$

showing the effects of flight path angle, thrust offset, and thrust variation with airspeed at constant throttle.

The most straight forward measurement method is probably to use a well-calibrated airspeed indicator and an accurate measure of vertical speed, such as a radar altimeter. The climb angle is then equal to

$$\sin^{-1} \left| \frac{\text{Vertical speed}}{\text{True airspeed}} \right|$$

VERIFICATION LESSONS LEARNED

Still air is necessary in any case, to minimize data scatter. Because of thrust and density variation it has been found necessary to keep altitude excursions small (less than 1000 ft) to get an acceptably accurate curve of flight path angle versus speed. The trim flight-path angle can have a marked effect on the results; the range of glide slopes expected in the operational and training missions should be tested.

MIL-STD-1797A
APPENDIX A

4.3.2 Flight path response to designated flight path controller.

When a designated flight path controller (other than the pitch controller) is used as a primary flight path controller, the short-term flight path response to designated flight path controller inputs shall have the following characteristics:_____. At all flight conditions the pilot-applied force and deflection required to maintain a change in flight path shall be in the same sense as those required to initiate the change.

REQUIREMENT RATIONALE (4.3.2)

These requirements are intended to be the primary flight path control criteria for STOL aircraft. These aircraft operate well on the back side of the power-required curve and therefore use a designated controller other than pitch attitude (such as throttle) to control flight path.

REQUIREMENT GUIDANCE

The related requirement of MIL-F-8785C is paragraph 3.6.2.

There is a large body of data for STOL flight path control with thrust and DLC devices. These data will be incorporated. Static stability is an obvious starting place. Also see Pinsker (RAE-TR-68140).

REQUIREMENT LESSONS LEARNED

5.3.2 Flight path response to designated flight path controller-verification.

Verification shall be by analysis, simulation and flight test.

VERIFICATION RATIONALE (5.3.2)

Verification will depend on the characteristics of the particular controller.

VERIFICATION GUIDANCE

Verification will depend on the characteristics of the particular controller.

VERIFICATION LESSONS LEARNED

4.3.3 Flight path control power

4.3.3.1 Control power for designated primary flight path controller.

If a separate controller (other than the pitch controller) is provided for primary control of direct lift or flight path, it shall be capable of producing the following changes in flight path following full actuation of the controller: _____. This shall be accomplished with pitch attitude held fixed and controls trimmed for an airspeed of _____.

4.3.3.2 Control power for designated secondary flight path controller.

The secondary controller shall be sufficient to produce the following changes in flight path: _____.

4.3.4 Flight path controller characteristics.

The breakout, centering, and force gradient characteristics of the designated flight path controller shall be within the following limits:

Breakout: \pm _____ lb

Centering: \pm _____ % of full travel

Force gradient: _____

REQUIREMENT RATIONALE (4.3.3 through 4.3.4)

This set of requirements, oriented toward STOL aircraft, defines the effectiveness and cockpit characteristics of the designated flight path controller. A designated primary controller might be a throttle; a designated secondary controller might be a speed-brake switch.

REQUIREMENT GUIDANCE

The related MIL-F-8785C requirement is paragraph 3.5.2.1.

These requirements are grouped together because of their similar purposes, and because there is not enough data to recommend values for them. A STOL amendment (to be published) will provide guidance.

REQUIREMENT LESSONS LEARNED

The C-X specification required the following flight-path change capability for maximum effort landing:

Speed	$\Delta\gamma$ (deg), ALL ENGINES OPERATING
V_{omin}	Level flight and -4.0
$V_{omin} \pm 5$ kt	± 2.0

5.3.3 Flight path control power

5.3.3.1 Control power for designated primary flight path controller-verification.

Verification shall be by analysis, simulation and flight test.

5.3.3.2 Control power for designated secondary flight path controller-verification.

Verification shall be by analysis, simulation and flight test.

5.3.4 Flight path controller characteristics-verification.

Verification shall be by analysis, simulation and test.

MIL-STD-1797A
APPENDIX A

VERIFICATION RATIONALE (5.3.3 through 5.3.4)

Verification will depend on the characteristics of the particular controller.

VERIFICATION GUIDANCE

Verification will depend on the characteristics of the particular controller.

VERIFICATION LESSONS LEARNED

4.4 Flying qualities requirements for longitudinal (speed) axis

4.4.1 Speed response to attitude changes.

The correlation between airspeed and pitch attitude shall be as follows: _____(i)_____.

With cockpit controls fixed or free, for Levels 1 and 2, there shall be no tendency for the airspeed to diverge aperiodically when the aircraft pitch attitude is disturbed from trim. For Level 3, the airspeed divergence must be within the following limits: _____(ii)_____.

REQUIREMENT RATIONALE (4.4.1)

This requirement is intended to assure that there is no aperiodic instability in attitude and airspeed during either piloted control or periods of unattended pilot operation.

REQUIREMENT GUIDANCE

The related MIL-F-8785C requirement is paragraph 3.2.1.1.

Recommendation for requirement (i):

Over an equilibrium speed range of 15 percent about trim or 50 kt, whichever is less, within the Service Flight Envelope, for Levels 1 and 2:

a. For rapid commanded pitch attitude changes the short-term airspeed change shall be in the same direction as the final value.

b. For a fixed positive change in commanded pitch attitude from trim, the steady-state airspeed shall not increase.

Recommendation for requirement (ii):

The time for the airspeed perturbation to double amplitude following a disturbance from trim, controls fixed and controls free, shall not be less than 6 seconds. Additionally, no airspeed divergence shall be allowed in the presence of one or more other Level 3 flying qualities unless the flight safety of that combination of characteristics can be demonstrated to the satisfaction of the procuring activity.

The first part of this requirement requires that airspeed track pitch attitude in the conventional way (airspeed decreases with increasing pitch attitude) both in the long and short term, in order to assure ease of piloting. The second part insures positive static stability for unattended operation (cockpit controls fixed or free) for Levels 1 and 2 and limits the amount of negative static stability for Level 3.

For either augmented or unaugmented aircraft, static stability means that restoring pitching moments are generated when the airspeed is disturbed from trim. Airspeed is easily measured—it is always available as a cockpit display. Furthermore, in most circumstances airspeed is a more meaningful cue to most pilots than angle of attack, which is not displayed at all on many aircraft and not much used except at low speed by pilots of some other aircraft.

From a piloting standpoint, pitch attitude is a primary longitudinal control variable. Pilots quickly learn that good control of pitch attitude generally leads to good control of airspeed and flight path. Hence it would seem possible that the desire for angle-of-attack stability is more related to pitch attitude than airspeed. Evidence to support this point of view can be found in good pilot acceptance of some systems with pitch rate command/attitude hold augmentation, which has zero static stability in the classical sense (control force or deflection vs. airspeed at constant throttle) but is allowed by this requirement. This static stability requirement supplements 4.2.1.1, which requires a positive phugoid damping ratio.

MIL-STD-1797A
APPENDIX A

For all but the most unconventional aircraft, the requirement on airspeed/attitude consonance is satisfied automatically throughout the Service Flight Envelope, in which the flying qualities requirements generally apply: the ratio is determined by the ratio of transfer-function numerators

$$\frac{u(s)}{\theta(s)} = \frac{N_{\delta}^u}{N_{\delta}^{\theta}} = \frac{(X_{\alpha} - g)(s + 1/T_{u_1})}{(1 + M_{\dot{w}}Z_{\delta}/M_{\delta})(s + 1/T_{\theta_1})(s + 1/T_{\theta_2})}$$

For $X_{\delta} = 0$ (expression adapted from WADC-TR-58-82), where δ generically represents either pitch control force or deflection, $1/T_{u_1}$ and $1/T_{\theta_2}$ are generally positive (stable). From WADC-TR-58-82,

$$1/T_{u_1} \doteq \frac{\zeta_{sp}\omega_{sp}}{\frac{\partial C_D}{\partial C_L^2} C_{N_{\alpha}} \left[1 - \frac{C_{m_q} + C_{m_{\dot{\alpha}}}}{2k_y^2 C_{N_{\alpha}}} \right]}$$

will always be roughly the same as $\zeta_{sp} \omega_{sp}$ but can be either greater or smaller. Since

$$\frac{1}{T_{h_1}} = \frac{1}{T_{\theta_1}} - g \frac{Z_u}{Z_{\alpha}} \left[\frac{1 - (Z_{\delta}/M_{\delta})(M_u/Z_u)}{1 - (Z_{\delta}/M_{\delta})(M_{\alpha}/Z_{\alpha})} \right]$$

$1/T_{\theta_1}$ goes through zero at an airspeed below that for zero $1/T_{h_1}$ -- see 4.3.1.2. As airspeed is decreased, $1/T_{\theta_1}$ becomes negative (unstable) somewhere between the speed for zero $d\gamma/dV$ and stall speed, and usually below V_{min} . A pilot tightly closing an inner attitude loop will tend to drive one of the closed-loop characteristic roots (of the transfer-function denominator) into $1/T_{\theta_1}$. This consonance requirement is incorporated in the standard primarily to insure acceptable airspeed response characteristics for augmented aircraft that may have unconventional airspeed response to changes in attitude, or aircraft with an unusually broad range of negative T_{θ_1} .

Most aircraft that meet the equivalent phugoid and short-period requirements of 4.2.1.1 and 4.2.1.2 should automatically meet the requirements of this section because of the inherent relationships between pitch attitude and airspeed. However, aircraft with some form of direct force control (such as DLC or autothrottles) may modify the classical attitude/airspeed relationship significantly. For example, a tight autothrottle loop will result in essentially zero airspeed change with changes in pitch attitude. In some flight conditions, with an offset or tilted thrust line it is conceivable that the autothrottle could result in increasing airspeed with increasing pitch attitude. Such undesirable characteristics would be disallowed by this requirement.

In accordance with classical definitions of static stability the prohibition of airspeed divergence will be considered satisfied if the gradients of pitch control force and deflection with airspeed are negative, that is, if the aircraft will return toward its trim airspeed after a speed disturbance, controls fixed or free. Insisting on a stable control position gradient can result in significant restriction in the aft c.g. limit if no more than downsprings and bobweights are used to improve controls-free stability. That limits aircraft utility. Downsprings and bobweights have been utilized on many successful aircraft--particularly commercial transports--to augment the stick force gradient when the stick position gradient is unstable, although overdoing that can induce a dynamic instability. The requirement on deflection gradient has been kept here as a reflection of the potentially greater demands of military missions and the tendency of an arm supported by a thigh or armrest to restrict stick motion when the pilot is grasping the control. With the use of "response feel", through feedback of normal acceleration and pitch rate in place of bobweights,

MIL-STD-1797A
APPENDIX A

downsprings, etc. and a fully-powered system, controls-fixed and controls-free stability become the same.

It is well recognized that the stick force gradient with airspeed is an important flying quality metric. Unfortunately, there seems to be no general agreement on what constitutes the lower boundary, short of neutral stability. Hence we require only that the gradient not be unstable. For Level 3 refer to guidance for 4.2.1.2.

The data supporting this requirement are the same as the data supporting the phugoid requirement in 4.2.1.1 and the Level 3 requirement in 4.2.1.2.

REQUIREMENT LESSONS LEARNED

The need for a convergent airspeed response for acceptable flying qualities is well recognized. Recent experience in testing modified control laws on the F-16 has shown that some level of speed stability is helpful in the approach flight condition. The rest of the augmentation insures good attitude stability with or without angle of attack feedback. However, pilots indicated that the speed cue (provided by the angle of attack feedback) was necessary at high angle of attack to avoid inadvertent stalls near the ground: an angle of attack signal comes in just below approach speed as a cue of stall approach, though at normal approach speed F-16 pilots prefer a pitch rate command.

The DFVLR variable-stability Hansa Jet used spoilers for direct lift control. It was found that without further compensation, the spoiler drag more than negated the improvements in flight-path control due to DLC.

The allowance of a divergent airspeed response for Level 3 is based on ground-based and in-flight simulation studies related to the Boeing SST, the B-1, and other configurations that have shown the apparent feasibility even of instrument landing with instabilities as great as 6 seconds to double amplitude. For prolonged flight with other high pilot workload, the less acute attention to piloting may further limit the allowable divergence. Actually, with complete pilot attention somewhat quicker divergences have appeared controllable. We have left some allowance for workload, design and loading uncertainties; pilot unfamiliarity with instability; and a range of possibilities for total damping. With regard to the last factor, Schuler (AFWAL-TR-82-3014) has shown that the 6-second limit is not necessarily conservative.

5.4 Flying qualities requirements for longitudinal (speed) axis-verification

5.4.1 Speed response to attitude changes-verification.

Verification shall be by analysis, simulation and flight test.

VERIFICATION RATIONALE (5.4.1)

A succinct description of measurement techniques for compliance with this requirement appears as Appendix IVA of AFFDL-TR-69-72 and is as follows:

The obvious method for determining the stick force gradient is to first trim the aircraft and then use the pitch attitude control alone to change and restabilize airspeed, leaving the throttle and trimmer controls at their trim settings. The altitude, of course, will vary constantly during this test; but careful programming of the test sequence can keep the altitude within reasonable bounds, for subsonic speeds. At low speed this test gives an excellent indication of phugoid stiffness or any divergent roots, though it is time-consuming. But at higher speeds, larger altitude changes are encountered during the runs. Then the lack of any unique relation between altitude and speed can cause difficulty, because compressibility effects are functions of both h and V . For example, gross differences in apparent stability are common transonically between results of airspeed variation at constant Mach number and results of Mach variation at constant airspeed. Neither of these latter two tests gives the desired result, which is an indication of long-term stability.

MIL-STD-1797A
APPENDIX A

The acceleration-deceleration method is popular because it, is the quickest. After trimming, the aircraft is decelerated to the specified lower limit of the speed range by reducing power and holding altitude constant with the elevator. The aircraft is next accelerated to the maximum specified speed and then decelerated to the trim speed. All this is done at constant altitude. The method is fast and data can be recorded continuously during the maneuver. One practical problem, however, is that unless the pilot changes power slowly and moves the elevator smoothly so that normal acceleration is held very close to 1.0, the data will include unwanted contributions from δ_e/n (constant speed).

At low speeds, the control force versus airspeed gradients obtained by the two methods will be essentially equal. At higher speed air density, the speed of sound will vary appreciably during static stability tests using the stabilized method (not during acceleration-deceleration tests, in which altitude is constant). It is not obvious which type of test most accurately measures static stability. It is obvious, however, that the stabilized method is very time-consuming and exhibits poor repeatability at high speed. For this reason, the acceleration-deceleration method is generally preferable for testing at high speeds.

A possible source of error with the acceleration-deceleration tests should be mentioned. The tests are usually conducted using off-trim throttle settings. The pitching moment and vertical force changes with speed at an off-trim throttle setting may be significantly different from those obtained at the trim throttle setting. Thrust-line offset from the c.g. and inlet airflow turning are sources of the difference. This difference can be accounted for by a priori knowledge of engine thrust and slipstream effects, or a small difference can be averaged out.

In view of the above discussion, the following techniques are recommended as a reasonable compromise between accuracy and practicality. At low speeds where the altitude changes associated with constant-throttle airspeed changes are small and where operation near the stall speed is required, the constant-power stabilized-airspeed method works very nicely. At high speeds (say $M > 0.4$) where the altitude excursions associated with the stabilized-airspeed method become larger, economy considerations dictate that some form of the acceleration-deceleration method be employed. To insure that the results of the test give a reasonable indication of throttle-fixed stability, hold normal acceleration as close to 1.0 g as is possible without use of abrupt control movements; data should only be taken during the parts with the throttle at the trim setting.⁶ For climbing or descending Flight Phases, other appropriate throttle settings should be used; but the acceleration-deceleration runs are still to be conducted in level flight.

In testing for compliance, if the control gradients obtained for a number of trim points are stable over the specified speed range, relatively few trim points will be needed. If an unstable region is found far from the trim point, however, the test should be repeated with the aircraft trimmed closer to the unstable region, the aircraft may or may not be stable within the specified speed range about the new trim point.

Aircraft having certain types of stability augmentation, such as rate-command/attitude-hold or maneuver-command systems, will have zero stick force gradients with airspeed. For these aircraft, the flight tests conducted to satisfy the phugoid stability requirements of 4.2.1.1 should be utilized to show compliance with this paragraph.

⁶ The combined effect of thrust and acceleration can be seen by comparing acceleration and deceleration data, but for showing specification compliance only the data for the trim throttle setting are pertinent.

MIL-STD-1797A
APPENDIX A

VERIFICATION GUIDANCE

In terms of effective stability derivatives, speed stability is neutral when the dynamic characteristic equation's coefficient of s^0 is zero, indicating one real root at the origin. From AFFDL-TR-65-218, this coefficient is known as E and:

$$\begin{aligned}
 E \propto & \cos \gamma_0 \left[(C_{L\alpha} + C_D) \left(\frac{V}{2} \frac{\partial C_m}{\partial u} - \frac{T}{\bar{q}S} \frac{z_T}{\bar{c}} + \frac{z_T}{\rho V S \bar{c}} \frac{\partial T}{\partial u} \right) - \right. \\
 & \left. C_{m\alpha} \left(C_L + \frac{V}{2} \frac{\partial C_L}{\partial u} + \frac{\sin \xi}{\rho V S} \frac{\partial T}{\partial u} \right) \right] \\
 & + \sin \gamma_0 \left[\left(\frac{V}{2} \frac{\partial C_m}{\partial u} - \frac{T}{\bar{q}S} \frac{z_T}{\bar{c}} + \frac{z_T}{\rho V S} \frac{\partial T}{\partial u} \right) (C_L - C_{D\alpha}) \right. \\
 & \left. + C_{m\alpha} \left(C_D + \frac{V}{2} \frac{\partial C_D}{\partial u} - \frac{\cos \xi}{\rho V S} \frac{\partial T}{\partial u} \right) \right] \\
 & = 0
 \end{aligned}$$

where $\bar{q} = \rho V_0^2 / 2$, z_T is the (normal) distance from the aircraft center of gravity to the thrust line (positive to TL below c.g.), and $\xi = \alpha + i_T$ is the inclination of the thrust line to the direction of motion. The expression is only half as complicated for level flight ($\gamma = 0$), and when further the u derivatives are negligible we have just

$$\frac{C_{m\alpha}}{C_{L\alpha} + C_D} = - \frac{T z_T}{W \bar{c}}$$

as the condition for neutral stability. $C_{m\alpha}$ of course varies with c.g. location, being more stable (negative) at forward c.g.'s.

AFFDL-TR-65-218 also gives methods to analyze the effects of spring tabs, downsprings, etc.

VERIFICATION LESSONS LEARNED

MIL-STD-1797A
APPENDIX A

4.4.1.1 Speed response to attitude changes--relaxation in transonic flight.

The requirements of 4.4.1 may be relaxed in the transonic speed range as follows: _____.
This relaxation does not apply to Level 1 for any Flight Phase which requires prolonged transonic operation.

REQUIREMENT RATIONALE (4.4.1.1)

Aircraft naturally exhibit local instabilities in the transonic region. Operation in this region is often transient in nature, and limited amounts of static instability have not been troublesome for the short term.

REQUIREMENT GUIDANCE

The related MIL-F-878SC requirement is paragraph 3.2.1.1.1.

Recommended values provided any divergent aircraft motions with speed are gradual and not objectionable to the pilot:

- | | |
|----------------|---|
| Levels 1 and 2 | For centerstick controllers, in 1-g flight no local force gradient shall be more unstable than 3 pounds per 0.01 M nor shall the force change exceed 10 pounds in the unstable direction. The corresponding limits for wheel controllers are 5 pounds per 0.01 M and 15 pounds, respectively. |
| Level 3 | For centerstick controllers, in 1-g flight no local force gradient shall be more unstable than 6 pounds per 0.01 M nor shall the force ever exceed 20 pounds in the unstable direction. The corresponding limits for wheel controllers are 10 pounds per 0.01 M and 30 pounds, respectively. |

The extent of the region that may be considered transonic has been left unspecified because of the difficulty in stating a definition that can be applied with generality. It is not the intent to define the transonic region as that where a relaxation is necessary; such a definition would leave essentially no requirement for stability. The lower end of the transonic region might be taken as the drag-rise Mach number, but the intent is not to penalize a design for minor speed instability in a region of only transient flight. The upper bound might be the Mach number at which the lift and drag approach the classical $(M^2 \cos^{2\Lambda} - 1)^{-1/2}$ variation with freestream Mach number, where Λ is the sweepback angle. A key point is that the relaxation should not apply at any flight condition at which an operational or training mission requires operation for any length of time.

Since phugoid oscillations involve speed changes, all speeds at which operational missions might require prolonged flight should be reasonably far removed from the region of transonic trim changes. Otherwise, normally encountered disturbances could cause divergence.

A statement should be included in the detailed system definition for each procurement delineating if the relaxation is to be applied and for which Flight Phases it is to be applied.

Also, see 4.2.8.3 Pitch axis control forces - control force variations during rapid speed changes.

REQUIREMENT LESSONS LEARNED

Transonic for the A-10, defined by the onset of compressibility effects, is Mach > 0.5, and is encountered routinely, for protracted periods, in tactical operations. The lesson is that low is relative.

5.4.1.1 Speed response to attitude changes--relaxation in transonic flight-verification.

Verification shall be by analysis, simulation and flight test.

MIL-STD-1797A
APPENDIX A

VERIFICATION RATIONALE (5.4.1.1)

See discussion for 4.4.1.

VERIFICATION GUIDANCE

In 5.4.1 guidance, the u-derivatives can be interpreted as having

$$\frac{V_0}{2} \frac{\partial C_m}{\partial u} = \frac{M}{2} \frac{\partial C_m}{\partial M}$$

etc., where M is Mach number.

Transition from subsonic to supersonic flight makes C_{m_α} more negative. For a given Mach number change, then the ΔC_m will be larger at higher angle of attack. Thus, a larger transonic trim change would be expected at high altitude, where the region is traversed at higher angle of attack.

VERIFICATION LESSONS LEARNED

With increasing speed, C_{m_α} may first become less stable before starting to increase at transonic speeds. But, the stable shift as flow becomes supersonic causes a tuck-under tendency. In the same Mach number range a flap-type elevator will decrease in effectiveness as the local flow becomes supersonic.

4.5 Flying qualities requirements for the roll axis

4.5.1 Roll response to roll controller

4.5.1.1 Roll mode.

The equivalent roll mode time constant, T_R , shall be no greater than the following: _____.

REQUIREMENT RATIONALE (4.5.1.1)

This requirement is directed at precision of roll control. For aircraft that exhibit classical spiral (large spiral time constant) and dutch roll (low $|\phi/\beta|$) characteristics, the equivalent roll mode time constant (T_R) describes the aircraft roll damping. For aircraft with a roll rate response that is not easily approximated by a first-order equation, an alternative specification such as bandwidth may be in order.

REQUIREMENT GUIDANCE

The related MIL-F-8785C requirement is paragraph 3.3.1.2.

Recommended values: For the equivalent roll and sideslip transfer function defined as follows, the maximum equivalent roll mode time constant, T_R , is given in table XXIV:

$$\frac{\phi}{\delta_{as} \text{ or } F_{as}} = \frac{K_{\phi} [\zeta_{\phi}, \omega_{\phi}] e^{-\tau} e^{ps}}{(1/T_S)(1/T_R)[\zeta_d, \omega_d]}, \quad \frac{\beta}{\delta_{rp} \text{ or } F_{rp}} = \frac{(A_3 s^3 + A_2 s^2 + A_1 s + A_0) e^{\tau e \beta}}{(1/T_S)(1/T_R)[\zeta_d, \omega_d]}$$

The equivalent system is to be fit to the higher-order system using algorithms similar to those specified in Appendix B of the Handbook, over the frequency range from 0.1 rad/sec to 10.0 rad/sec. Use δ for deflection control systems (pilot controller deflection commands the control effector) and F for force control systems (pilot controller force commands the control effector).

TABLE XXIV. Recommended maximum roll-mode time constant (seconds).

FLIGHT PHASE CATEGORY	CLASS	LEVEL		
		1	2	3
A	I, IV	1.0	1.4	10
	II, III	1.4	3.0	
B	All	1.4	3.0	
C	I, II-C, IV	1.0	1.4	
	II-L, III	1.4	3.0	

The equivalent time delay, $\exp(-\tau_{ep}s)$, is included to represent assorted effects of higher-order modes, lags and time delays in the flight control system. Where the roll response to F_{as} contains a significant amount of dutch roll mode, this transfer function should be matched simultaneously with the equivalent-system transfer function of lateral-acceleration response to roll control force. (In general this latter transfer function has a fourth-order numerator, but not all of its zeros may be within the frequency range of interest).

There are considerable data to show that pilot rating is a function of roll damping, for example figure 132 (from AFFDL-TR-65-138). Roll damping is generally expressed in terms of the first-order roll mode time

MIL-STD-1797A
APPENDIX A

constant, T_R , of the roll rate response following a step rolling moment input. Therefore, a direct requirement on T_R has been specified.

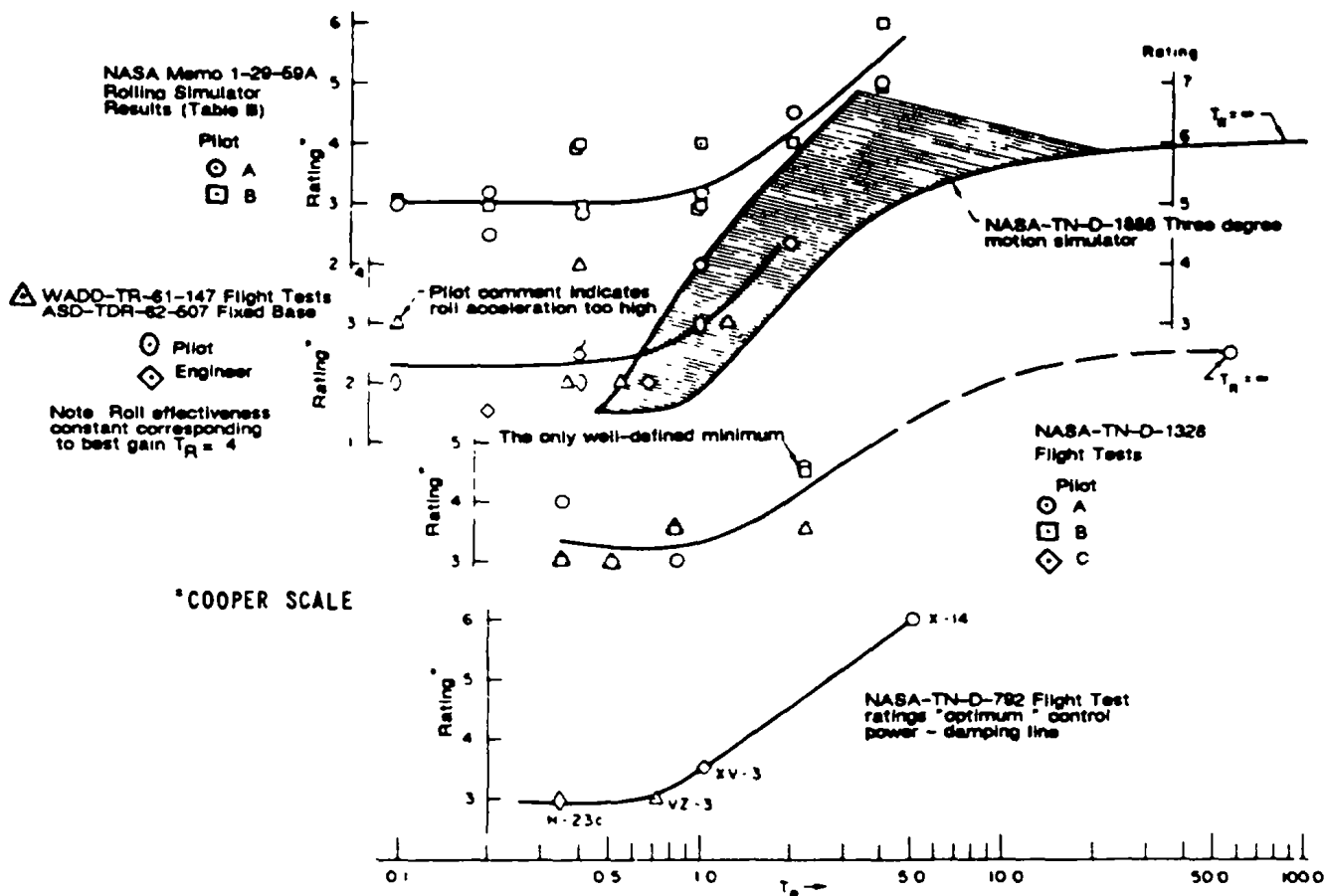

FIGURE 132. Ratings versus roll damping - flight test, moving-base, fixed base with random input (from AFFDL-TR-65-138).

Limits for the other parameters in the p/F_{as} transfer function, Equation 1, are given in other paragraphs in this Handbook.

SUPPORTING DATA

AFFDL-TR-69-72 contains a concise description of data available for development and support of the recommended values of table XXIV. The following discussion is primarily taken from AFFDL-TR-69-72.

Level 1 Requirements

The starting point for specification of the criteria was the recommendation pertaining to roll mode time constant given in AFFDL-TR-65-138 and NASA Memo 1-29-59A. Both report on extensive surveys of roll flying qualities and so are directly applicable to this effort. NASA Memo 1-29-59A proposes a maximum $T_R = 1.3$ seconds for Class IV aircraft and $T_R = 1.5$ seconds for all other classes (figure 133). From theoretical considerations and from analysis, AFFDL-TR-65-138 concluded that "The maximum value of T_R considered satisfactory is about 1.3 to 1.5; and there is no strong evidence in existing data or theory

MIL-STD-1797A
APPENDIX A

for allowing this value to increase with airplane size or mission." While there is still no strong evidence to indicate that the requirements can be relaxed, several reports on in-flight evaluations (NASA-TN-D-3726, Princeton Univ Rpt 727, and AFFDL-TR-67-98) indicate that, for Class I and IV aircraft performing precision tasks, even shorter values of T_R are required to obtain satisfactory flying qualities.

Princeton Univ Rpt 727 (figures 134, 135, and 136) shows that maximum satisfactory T_R for fighter aircraft for a carrier approach is approximately 1 second. AFFDL-TR-67-98 (figure 137) shows that with a T_R of 1.3 seconds, the best pilot rating obtained was 5 and in conclusion stated, "Because of the roll control difficulties the pilot experienced with the long roll mode time constant configuration, it was concluded that a roll mode time constant of 1.3 seconds or greater is unsatisfactory for a fighter mission." One prominent manufacturer of fighter aircraft stated that fighter aircraft should have a T_R of 0.6 to 0.8 seconds. NASA-TN-D-3126 indicates, from consideration of time required to reach maximum roll rate, that Class I and small Class II aircraft require reasonably short roll mode time constants as well.

The data of NASA Memo 1-29-59A (figures 138 through 142) have been widely referenced and interpreted, as for example in AFFDL-TR-65-138 and NADC-ED-6282. It should be noted, however, that the in-flight evaluations in NASA Memo 1-29-59A were all for T_R less than 0.8 seconds (figure 141) and any conclusions about roll mode time constants longer than 0.8 seconds would be based on the ground simulation data only. In general, the in-flight ratings of NASA Memo 1-29-59A were worse than for the single-degree-of-freedom ground simulation ratings (figure 142). This indicates that the presented one-degree-of-freedom data (figure 140) may be a little optimistic. This difference in pilot ratings was discussed in NASA Memo 1-29-59A:

The principal argument is that the pilots' opinion of roll performance was adversely influenced by the coupling between the modes of motion which exist to some degree in all airplanes, but which for airplane D and for the low speed range of airplane F [see figure 132] were excessive, and which the single-degree-of-freedom analysis used herein obviously does not take into account. However, for airplane F, as the speed was increased the rolling motions approached those described by a single-degree-of-freedom system and correspondingly the actual pilot rating approached the predicted rating. Secondary factors which may have contributed to the above trend, wherein the actual rating was greater than the predicted, were objectionable control system dynamics and control system forces which may have been present.

So the simulator data (figures 138 and 139) may be considered to represent ideal aircraft.

Since, in general, a knee occurs in most of the data at approximately $T_R = 1$ second (figure 132), and since $T_R = 1$ second is at least consistent with all pertinent data, this value has been selected as the recommended Level 1 limit for Class I, II-C, and IV aircraft for Flight Phase Category C, and for Class I and IV aircraft for Flight Phase Category A.

MIL-STD-1797A
APPENDIX A

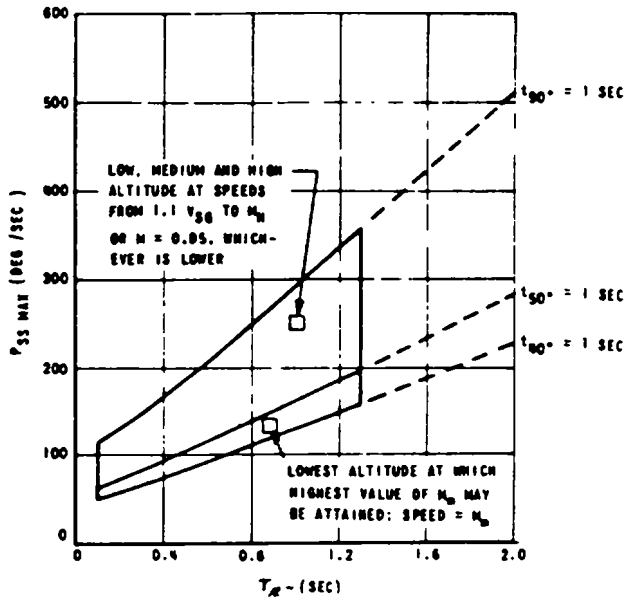

FIGURE 133. Proposed roll performance requirements (MIL-F-8785) for Class III aircraft (from NADC-ED-6282).

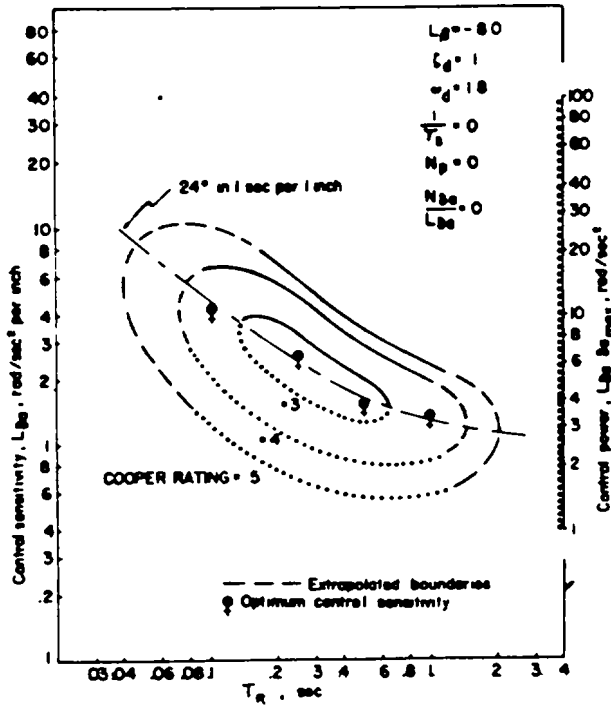

FIGURE 134. Lateral control boundaries (from Princeton Univ Rpt 727).

MIL-STD-1797A
APPENDIX A

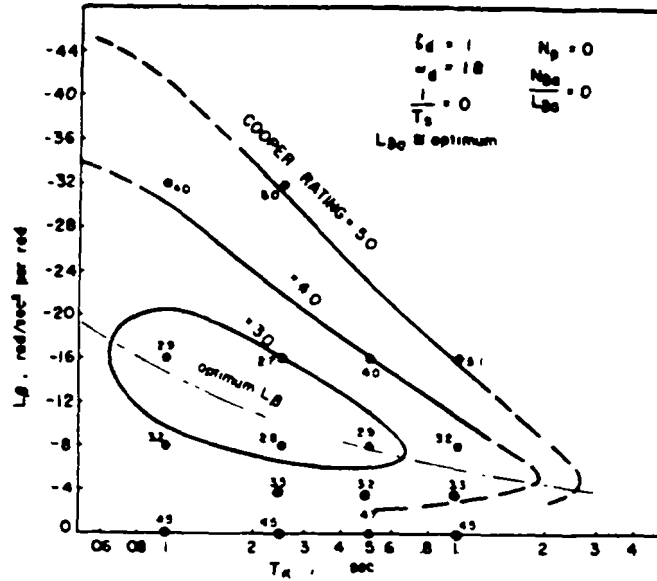

FIGURE 135. Lateral flying qualities boundaries (L_{β} vs. T_R , $\zeta_d = 0.1$) (from Princeton Univ Rpt 727).

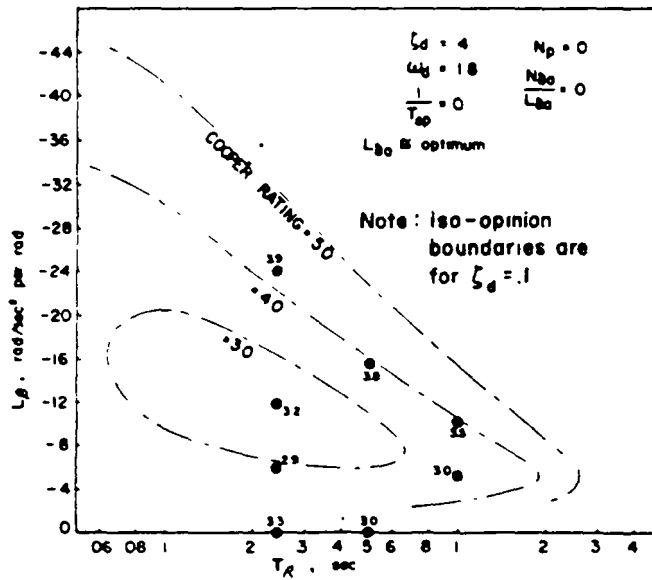

FIGURE 136. Lateral flying qualities boundaries (L_{β} vs. T_R , $\zeta_d = 0.4$) (from Princeton Univ Rpt 727).

MIL-STD-1797A
APPENDIX A

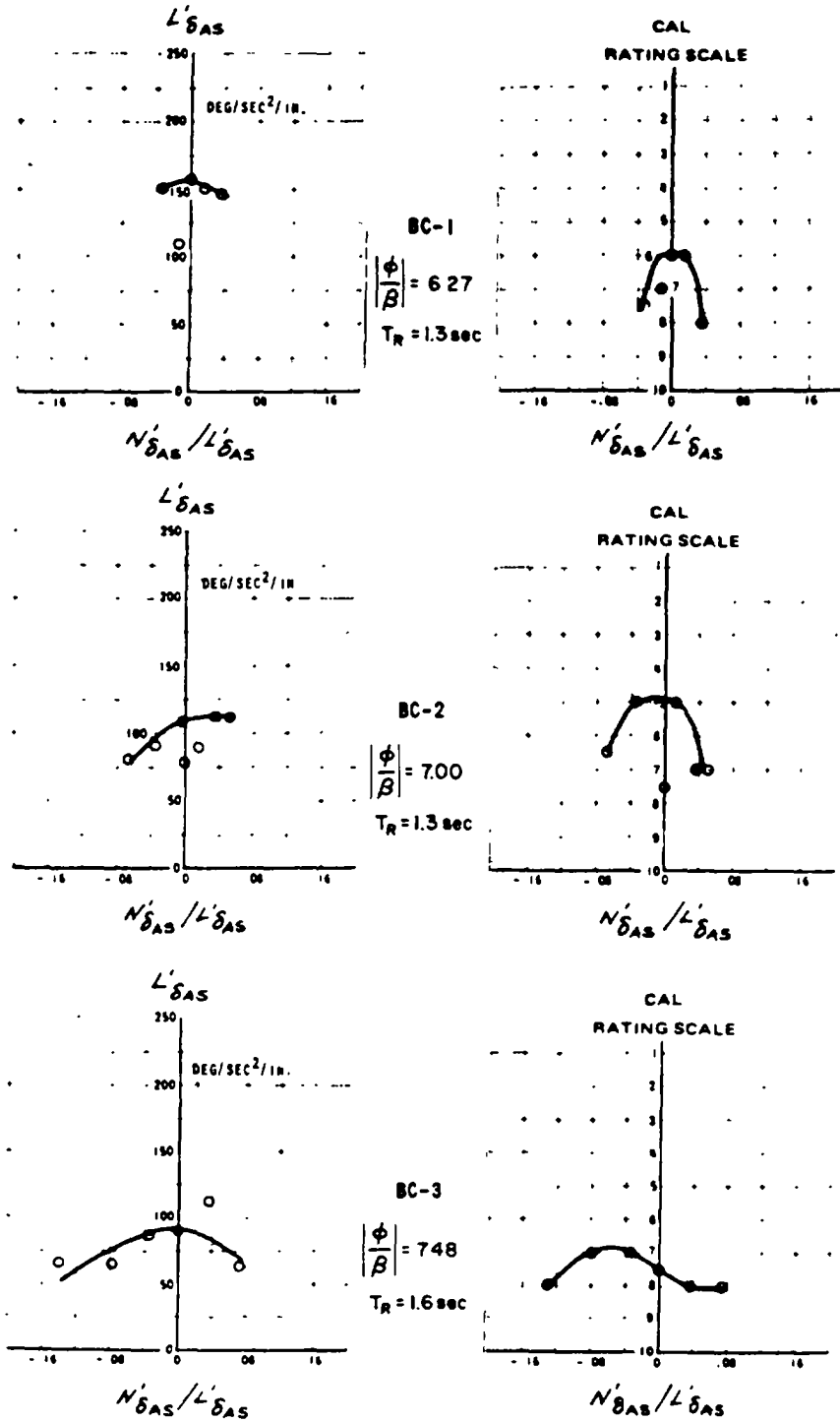

FIGURE 137. Pilot ratings and optimum aileron sensitivity (Medium $\left| \frac{\phi}{\beta} \right|_d$, Long T_R) (from AFFDL-TR-67-98).

MIL-STD-1797A
APPENDIX A

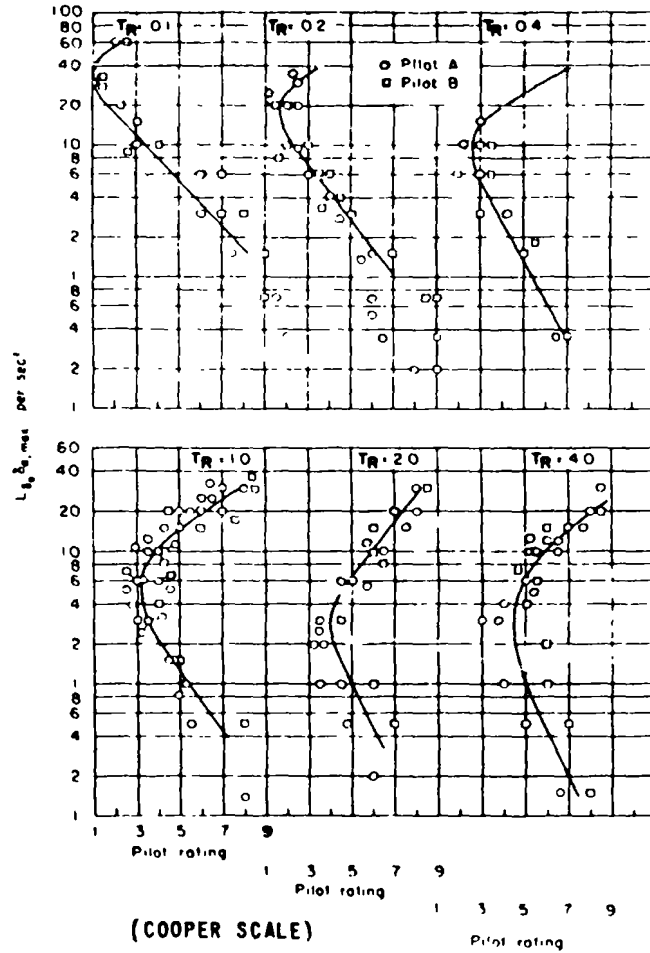

FIGURE 138. Variation of pilot opinion with L_{δ_a} $\delta_{a_{max}}$ for constant values of T_R as obtained from the stationary flight simulator (from NASA Memo 1-29-59A).

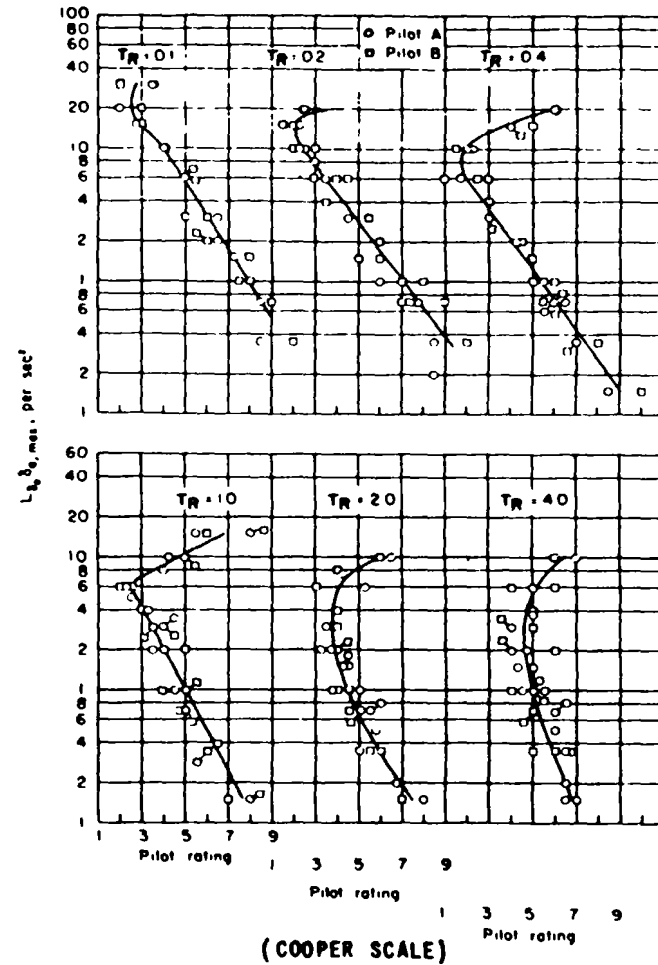

FIGURE 139. Variation of pilot opinion with L_{δ_a} $\delta_{a_{max}}$ for constant values of T_R as obtained from the moving flight simulator (from NASA Memo 1-29-59A).

MIL-STD-1797A
APPENDIX A

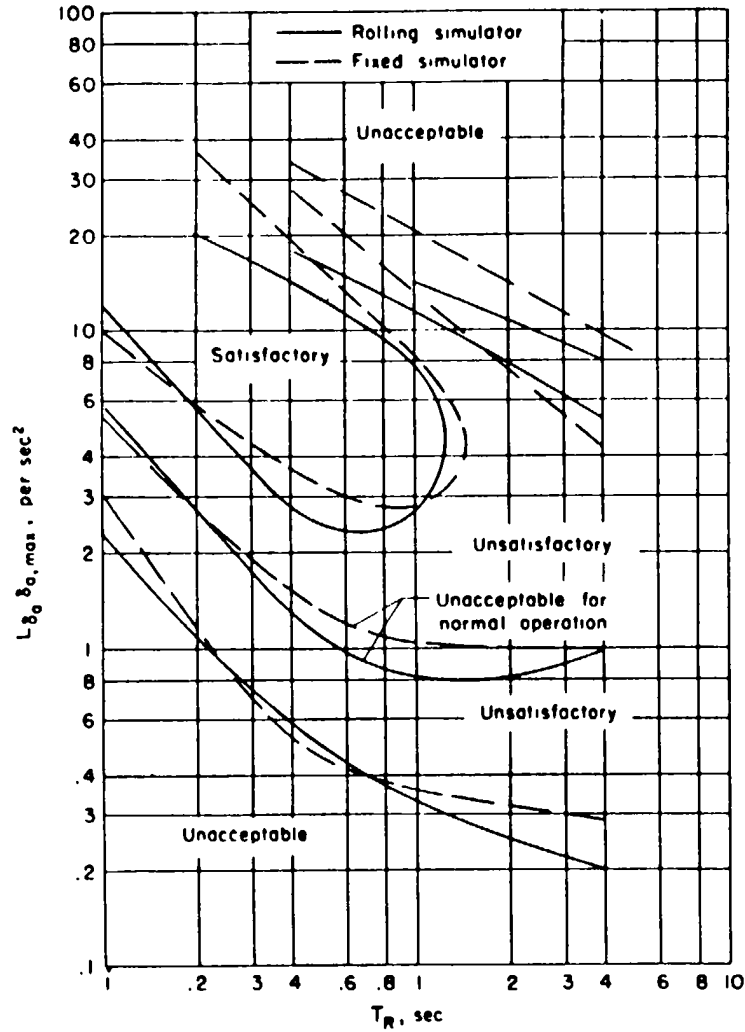

FIGURE 140. Comparison of pilot opinion boundaries obtained from the fixed and moving flight simulators (from NASA Memo 1-29-59A)

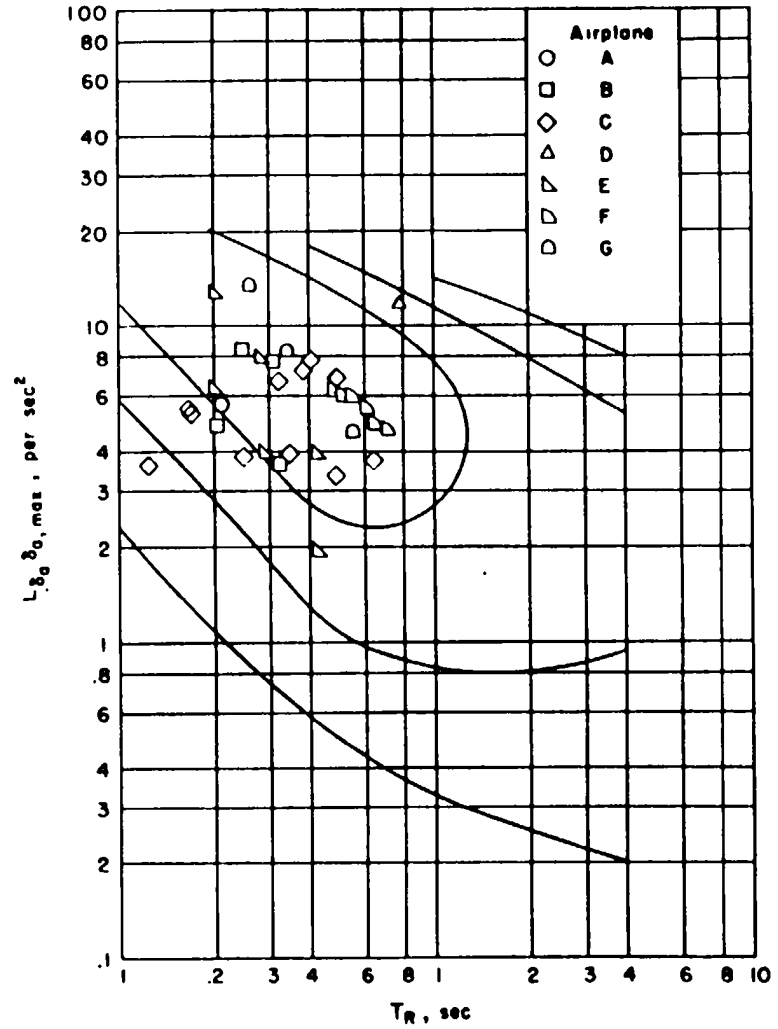

FIGURE 141. Range of parameters $L_{\delta_a} \delta_{a_{max}}$ and T_R covered in the flight investigation, shown in comparison with the motion simulator driven boundaries (from NASA Memo 1-29-59A).

MIL-STD-1797A
APPENDIX A

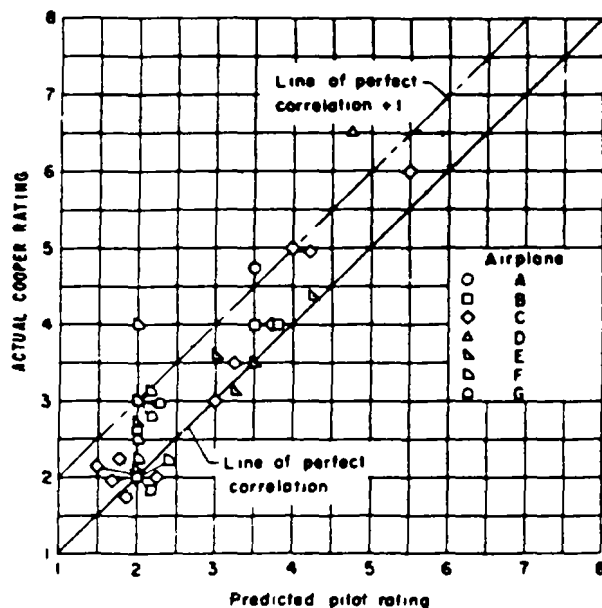

FIGURE 142. Comparison of in-flight pilot-opinion rating with those predicted from flight simulator boundaries (from NASA Memo 1-29-59A).

For Class I and IV aircraft performing Flight Phase Category B tasks, and for Class II-L and III aircraft performing all tasks, available data support a maximum value of $T_R = 1.3$ to 1.5 seconds; an average value of $T_R = 1.4$ seconds was selected. Ground simulator data in NASA-TN-D-1888 tend to support this value for large aircraft (cross-hatched curves in figure 132); and in-flight data in WADD-TR-61-147 for small Class II airplanes, Flight Phase Category B (figure 143), support a T_R at least greater than 1.2 seconds.

An additional consideration that is demonstrated by much of the data, for example Princeton Univ Rpt 727 and AFFDL-TR-65-39, is that the required T_R is, to a degree, determined by the value of L_β or $|\phi/\beta|_d$. The in-flight data of Princeton Univ Rpt 727 (figures 135 and 136) show this dependence directly. In the opinion of the author of AFFDL-TR-65-39, the main reason for the differences between the data of AFFDL-TR-65-39 and the data to which it is compared (see figure 144) is that the AFFDL-TR-65-39 ground simulator data were based on a much larger value of $|\phi/\beta|_d$. In addition, the lack of an adequate flight path display for the simulated high-speed condition ($M = 1.2$) of AFFDL-TR-65-39 may have contributed. The pilot ratings of both the AFFDL-TR-65-39 and Princeton Univ Rpt 727 data are degraded because of the response to atmospheric disturbances. This phenomenon is discussed in the substantiation for the paragraph covering the response to atmospheric disturbances.

Level 2 Requirements

AFFDL-TR-65-138 and NASA-TN-D-1888 do not make recommendations for Level 2 criteria as they did for Level 1. However, using available pilot rating data, it is possible to select values of T_R that are consistent with available data.

MIL-STD-1797A
APPENDIX A

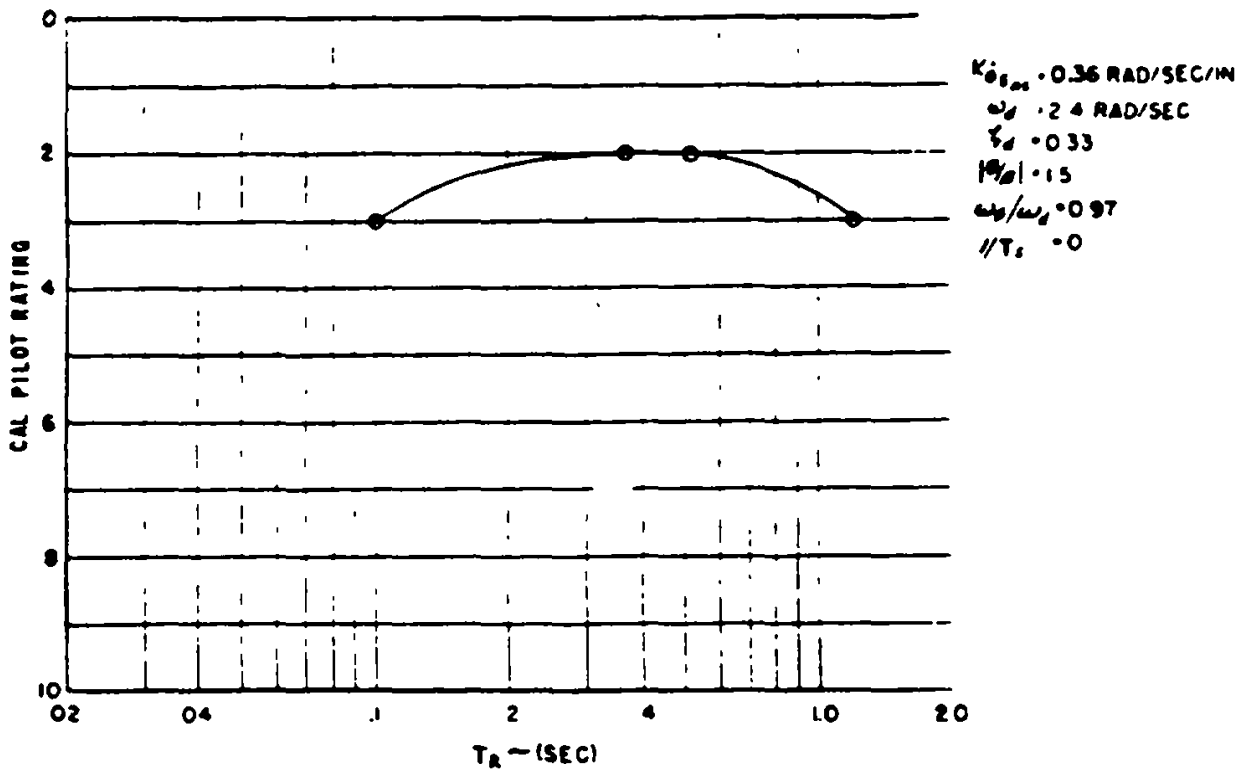

FIGURE 143. Pilot rating versus roll mode time constant (from WADD-TR-61-147).

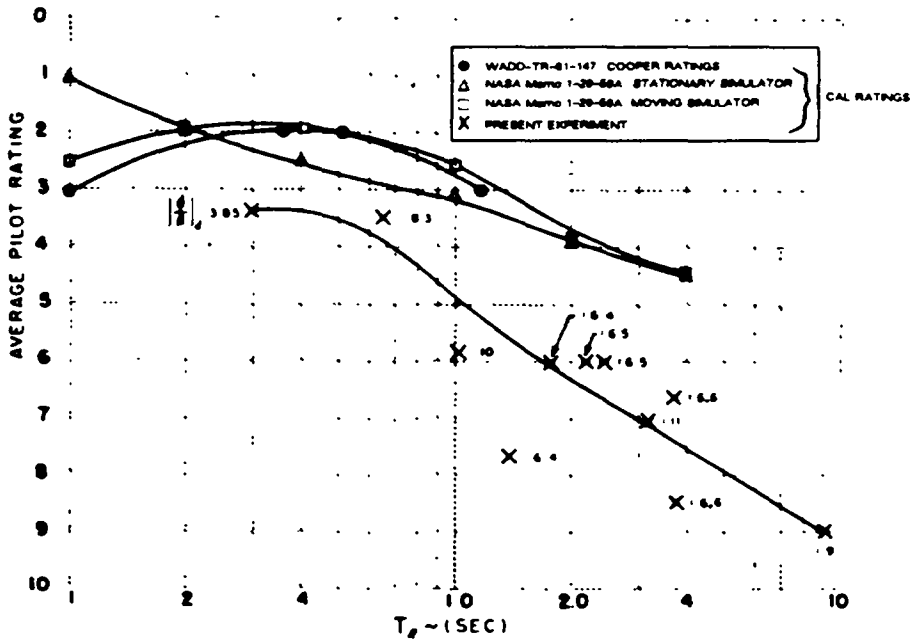

FIGURE 144. Average pilot rating of roll mode time constant (from AFFDL-TR-65-39).

MIL-STD-1797A
APPENDIX A

Examination of figure 132 (from AFFDL-TR-65-138), which summarizes data from NASA Memo 1-29-59A and NASA-TN-D-1888, shows that for a change in pilot rating from 3-1/2 to 5 or 5-1/2, T_R goes from approximately 1.3 to 3 seconds. Thus, even though the NASA Memo 1-29-59A data are based on a fighter mission, the data do indicate the gradient of pilot rating with T_R over the noted ranges. AFFDL-TR-67-98 indicates, from in-flight evaluations, that for fighter aircraft performing precision and maneuvering tasks, the pilot ratings degraded to marginally acceptable for T_R of 1.3 to 1.6 seconds. For large aircraft, RAE Aero 2688 suggests T_R values of 2.3 seconds for the satisfactory boundary and 6 seconds for acceptable; however, these levels are probably associated with somewhat poorer flying qualities than the Levels 1 and 2 of paragraph 1.5. The Level 2 recommendations were selected from these considerations.

Level 3 Requirement

A Level 3 value of $T_R = 10$ seconds is relatively arbitrary but is based on data of AFFDL-TR-65-39 (figure 144) for fighter aircraft. While the selected value cannot be vigorously defended, it does legislate against unstable roll modes while permitting effective acceleration-like responses to control inputs such as can be obtained on wingless vehicles.

REQUIREMENT LESSONS LEARNED

A comprehensive series of flight tests was recently conducted on the variable stability NT-33 to investigate the effect of higher-order system dynamics on lateral handling qualities (LATHOS for Lateral High-Order Systems, AFWAL-TR-81-3171), figure 145. Values of T_R within the existing Level 1 boundary were tested. However, the data for $1/T_R$ greater than 1 supports the current boundary ($T_R < 1.0$ sec) up to a value of $1/T_R = 3$ ($T_R = 0.33$). For $1/T_R$ greater than 3 the pilot ratings show a consistent degradation, a trend that is not included in the current requirement. The pilot comments for these cases center about excessive lateral abruptness and roll ratcheting. These results are supported by the fact that some modern airplanes equipped with high-gain command augmentation systems (CAS) have short T_R and also experience excessive lateral sensitivity which has been described as roll ratcheting. CAS characteristics which may alleviate roll ratcheting are discussed at length in 4.5.9.3. The following will examine only the effects of low values of T_R .

Several examples of ratcheting are shown in figures 141, 143, and 144 of 4.5.9.3. The phenomenon is characterized by near-limit-cycle oscillations at frequencies between 2 and 3 cycles per second (12 to 18 rad/sec), well above the frequency of pilot control in the roll axis. The apparent dominant factor in ratcheting is excessive control gain (i.e., stick sensitivity) at these high frequencies. It has been suggested (Calspan FRM No. 554) that the root cause of ratcheting involves pilot closed-loop response to lateral acceleration cues: with a reasonable pilot lag, a closed-loop instability can exist when T_R is too short.

A related possible explanation for ratcheting is physiological in nature. That is, since the mass combination of pilot hand/arm and control stick are subjected to abrupt lateral accelerations, the effect would be a bobweight which would feed back to the aircraft motion. This phenomenon has been related to longitudinal pilot-induced oscillations (NORAIR Rpt No. NOR-64-143). Experiments conducted at the Air Force Aerospace Medical Research Laboratory (AMRL) investigated pilot control performance while experiencing sinusoidal lateral vibrations (AMRL-TR-73-78). A simple roll-bar-tracking maneuver with a well-behaved controlled element was utilized. Figure 146 compares results of this experiment with an analytical model for stick deflection response to lateral accelerations. Pilot closed-loop tracking was at around 5 rad/sec, while an oscillatory arm/stick bobweight mode occurred at about 2 cycles per second (12 rad/sec) -- near the frequencies of the observed ratcheting oscillations in the LATHOS experiment.

MIL-STD-1797A
APPENDIX A

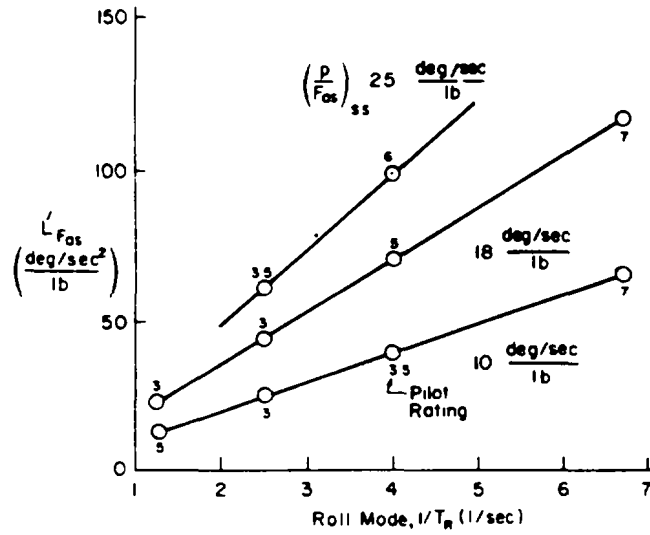

FIGURE 145. Effect of roll mode LATHOS (AFWAL-TR-81-3171), Category A.

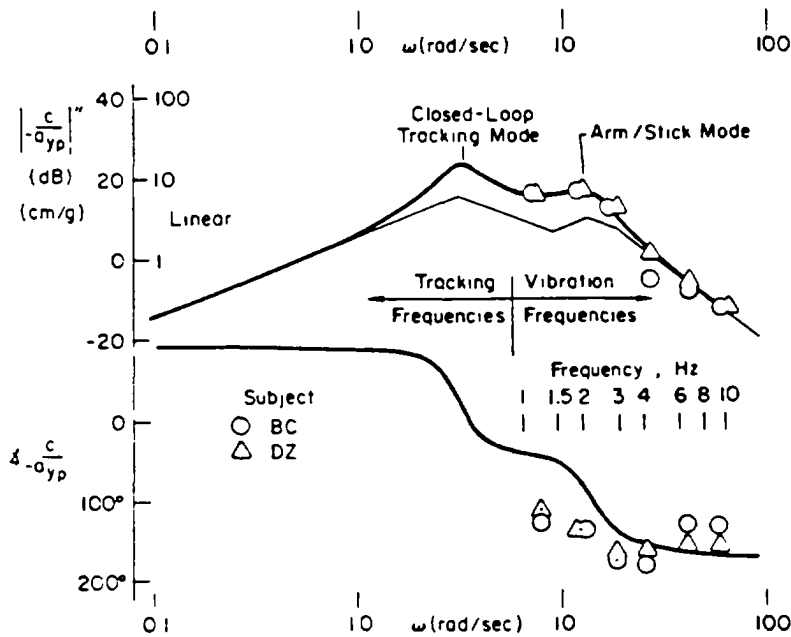

FIGURE 146. Comparison of models and data for closed-loop stick deflection responses under lateral vibration (AMRL-TR-73-78).

Several solutions to the problem of excessive sensitivity have been found. These are discussed in conjunction with the roll sensitivity discussion in 4.5.9.3. Those solutions are to: 1) decrease the stick sensitivity around neutral; 2) avoid too-low augmented-aircraft values of $1/T_R$; and 3) add a low-frequency stick prefilter with a break frequency of at least 10 rad/sec.

MIL-STD-1797A
APPENDIX A

Reduction of stick sensitivity for CAS-equipped aircraft is relatively straightforward. Use of nonlinear gradients (p/F_{as}) on LATHOS reduced the sensitivity only slightly but improved pilot ratings from 7 to 4 (see figures 145 and 146). It is clear that low sensitivity-around neutral is essential for acceptable flying qualities.

Prefilters in the forward path were found to alleviate ratcheting on both LATHOS and the YA-7D DIGITAC (AFFTC-TR-76-15). The time constants of the filters were well into the range of pilot crossover ($1/T_F$ around 3 rad/sec), and their effect as observed by the pilot was to smooth aircraft response (i.e., increase T_R). However, this should not be considered as a universal fix to the problem of sensitivity, since the aircraft response to outside disturbances might still be unacceptably abrupt. More importantly, prefilters can add considerable equivalent time delay to the system. In the longitudinal axis, a first-order lag $1/T_L$ of 3 rad/sec adds more than 0.1 sec to overall equivalent time delay, τ_e (see figure 18a). For the T-33 LATHOS experiment, where basic τ_e due to actuators was small (0.028 sec), this equivalent time delay was not significant. But on a highly augmented aircraft where structural filters, sensor filters, digital time delay, etc., may already contribute considerable lag, a prefilter could make the aircraft totally unacceptable due to excessive time delay. The effect of time delay on pilot rating was considerable in the LATHOS experiment as shown in figure 168.

In summary, a large value of $1/T_R$ appears to result in excessive gain at high frequencies (see figure 147) which seems to be the root cause of roll ratcheting. The resulting lateral acceleration on the pilot would seem to account for the observed difference between in-flight and ground-based simulator results. The ratcheting can be alleviated to some extent by reducing the stick gain for small inputs, i.e., most high-frequency control activity occurs close to neutral roll command (see figure 194). However, resisting the temptation to overaugment $1/T_R$ seems to be the best overall solution. Even then, some nonlinear stick shaping will most likely be required (see figure 194).

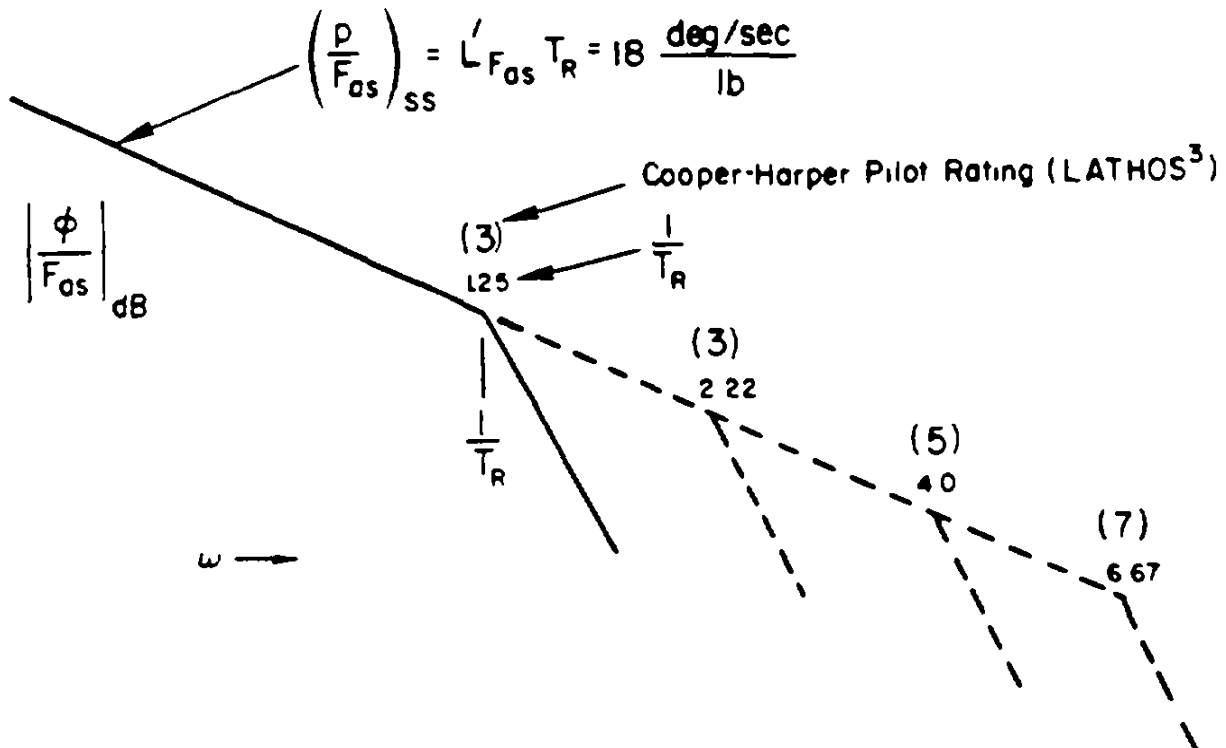

FIGURE 147. Effect of $1/T_R$ on high-frequency gain.

5.5 Flying quality requirements for roll axis-verification

5.5.1 Roll response to roll controller-verification

5.5.1.1 Roll mode-verification.

Verification shall be by analysis, simulation and flight test.

VERIFICATION RATIONALE (5.5.1.1)

The considerable advances made in modeling higher-order aircraft responses with equivalent systems have, largely, been only for the pitch axis. Similar work is clearly necessary in the roll and yaw axes. It is expected that application of this requirement will involve some sort of reduced-order matching, whether it be by frequency (Appendix B) or time (AFFDL-TR-69-72) domain techniques. At this time inadequate information exists to supply significant guidance for applying equivalent systems to meet this requirement.

If the roll response is classical in nature (i.e., defined by the spiral, dutch roll, and roll modes), conventional techniques may be utilized to determine T_R (see, for example, AFFDL-TR-69-72, Appendix VB).

VERIFICATION GUIDANCE

Compliance is easily demonstrated through flight testing at the minimum and maximum specified operational altitudes, over the range of service speed, with the aircraft configured for maximum rolling moment of inertia.

The roll rate response to a step roll control input for aircraft with conventional response is usually made up of three distinct modes: the roll mode, the spiral mode, and the dutch roll mode. If linearity is assumed, the principle of superposition applies. Then any point on the roll rate trace at any given time must be the sum of these three modes at that time. Therefore, if the three modes can be identified on the roll rate trace, it is possible to extract the roll mode time constant, T_R .

The given p/F_{as} response function can be transformed to the time domain. Assuming τ_{ep} is small, the roll rate time history following a step roll control input is given by:

$$\frac{p(t)}{\delta_{a\text{step}}} = K_s e^{-t/TS} + K_R e^{-t/TR} + K_d e^{-\zeta_d \omega_d t} \cos \left[\omega_d \sqrt{1 - \zeta_d^2} t + \varphi_p \right]$$

For a normal aircraft the roll mode, characterized by the first-order time constant, T_R , takes on the following form following a step aileron input:

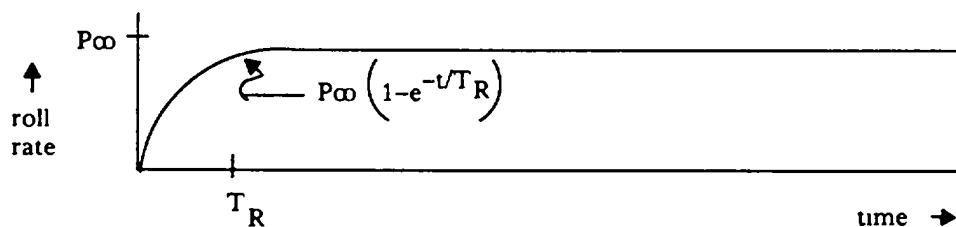

where

MIL-STD-1797A
APPENDIX A

$$\frac{1}{T_R} \approx \frac{-\rho Vg}{4(w/S)k_x^2} \left[C'_{\ell p} - \frac{C'_{\ell \beta}}{C'_{n\beta}} (C'_{np} - 2k_z^2 C_{L1}) \right]$$

$$C'_{\ell i} = \frac{C_{\ell i} + C_{n i} l_{xz} / l_z}{1 - l_{xz}^2 / (l_x l_z)} \quad , \quad C'_{n i} = \frac{C_{n i} + C_{\ell i} l_{xz} / l_x}{1 - l_{xz}^2 / (l_x l_z)}$$

$$C_{L1} = W / (\bar{q} S), \quad k_x^2 = l_x / (mb^2), \quad k_z^2 = l_z / (mb^2)$$

For a rate-limited control input, take time = 0 at the midpoint of the ramp to determine T_R .

Methods of extracting values of T_R from flight test data are given in AFFDL-TR-69-72.

VERIFICATION LESSONS LEARNED

MIL-STD-1797A
APPENDIX A

4.5.1.2 Spiral stability.

The combined effects of spiral stability, flight control system characteristics and rolling moment change with speed shall be such that following a disturbance in bank of up to 20 degrees, the time to double bank-angle amplitude is no less than _____seconds. This requirement shall be met with the aircraft trimmed for wings-level, zero-yaw-rate flight and the cockpit controls free.

REQUIREMENT RATIONALE (4.5.1.2)

The requirements on spiral stability are aimed primarily at insuring that the aircraft will not diverge too rapidly in bank from a wings level condition during periods of pilot inattention.

REQUIREMENT GUIDANCE

The related MIL-F-8785C requirement is paragraph 3.3.1.3.

The spiral mode, characterized by slow rolling and yawing responses to a roll disturbance, is generally not a problem for the pilot during fully attended operations (air combat, landing, etc.). However, spiral divergence during low-gain tasks can be a nuisance and even a dangerous condition if the divergence is too rapid. A limit on time to double amplitude for the spiral mode is necessary for safety during such operations. There is as yet no clear need for, or definition of, a limit on positive spiral stability (discussed in Supporting Data). Indeed, a coupled roll-spiral mode (4.5.1.3) might sometimes be desirable: for example, attitude command on landing approach, where fine tracking but no rapid, gross maneuvering is required. The roll and yaw control forces in steady turns are bounded in 4.5.9.5.1 and 4.6.7.2, respectively.

SUPPORTING DATA

NADC-ED-6282 recommended retention of the existing $T_2 > 20$ seconds requirement and also proposed a requirement, $T_{1/2} > 10$ seconds, on the degree of positive spiral stability permitted. The recommended allowable instability of table XXV is similar, in that for Flight Phase Category B (analogous to the cruise configuration) the time to double amplitude is $T_2 > 20$ seconds. But for Flight Phase Categories A and C, where the pilot is generally closing a tight attitude loop, a less stringent value of $T_2 > 12$ seconds was selected.

TABLE XXV. Spiral stability -- recommended minimum time to double amplitude.

FLIGHT PHASE CATEGORY	LEVEL 1	LEVEL 2	LEVEL 3
A and C	12 sec	8 sec	4 sec
B	20 sec	8 sec	4 sec

Grouping Category C Flight Phases with Category A Flight Phases is based on the consideration that during Category A and C Flight Phases the pilot is in more continuous control of the aircraft than in Category B Flight Phase and is therefore less concerned about long-term attitude characteristics. This point was demonstrated in the TIFS Phase I landing approach experiments reported in AFFDL-TR-71-164. Spiral roots with time to double of 9.6 sec were hardly noticed and a case with time to double of 6.4 sec, although noted, was not considered reason for downgrading the evaluation. Based on these data together with the extensive data in FAA-ADS-69-13 and NRC of Canada Rpt LTR-FR-12, it is recommended that the Level 2 limit on T_2 be 8 sec. Even this limit is a conservative interpretation of the data in FAA-ADS-69-13, which could be used to support a value of $T_2 = 6$ sec for Level 2. The gradient of pilot rating with time to double is steep, however, and a conservative interpretation is believed justified.

MIL-STD-1797A
APPENDIX A

The data of Cornell Aero Lab TB-574-F-6 (figure 148) tend to suggest, however, that a higher value of T_2 might be justified for Level 2.

CRUISE CONDITION, SPEED 195 KT IAS. 10,000 FT (APPROX)

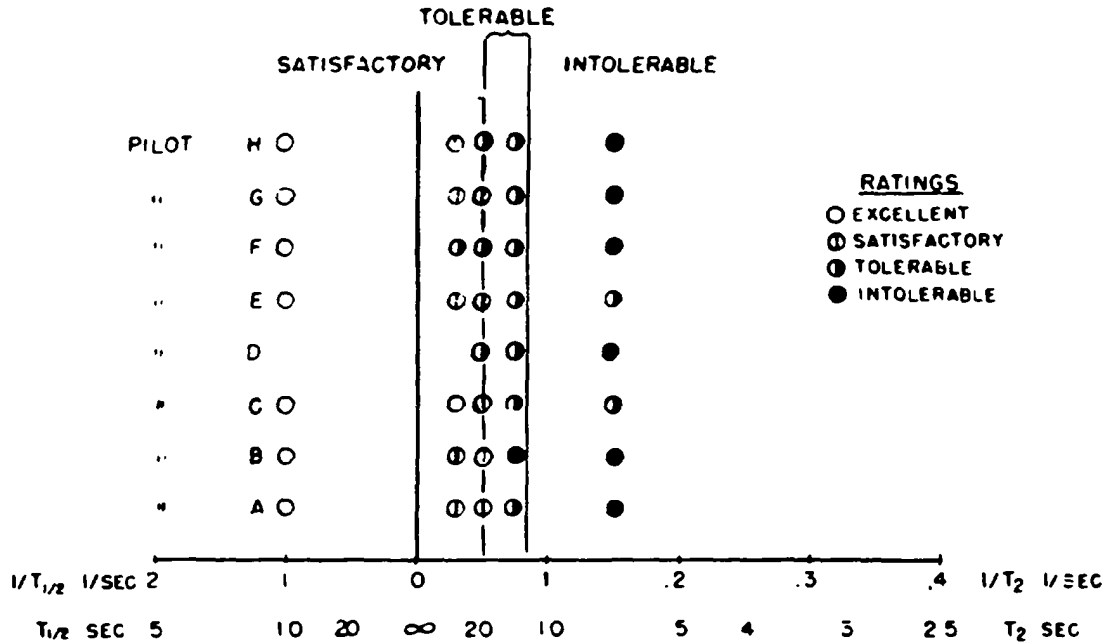

FIGURE 148. Limits of satisfactory and tolerable rates of spiral divergence (from Cornell Aero Lab TB-574-F-6).

For Level 3, a value of $T_2 > 4$ seconds was selected as a compromise between what is flyable and what is controllable if the pilot cannot devote full attention to flying the aircraft. This subject was discussed as follows in Cornell Aero Lab TB-574-F-6:

The minimum tolerable time to double amplitude of the spiral divergence was very much longer than the minimum allowed by the existing handling qualities specifications (reference [Navy BuAero-R-119B/USAF-C-1815B]). It is believed that the concept of the spiral divergence being unimportant to the pilot, because it is slow enough to be controlled, had led to considerable confusion on the subject. It is true that the pilot can control an airplane with a very rapid divergence (say, time to double amplitude of 2 or 4 seconds) when he has nothing to do but fly the airplane. Therefore, tests made with a rapid divergence where the pilot devoted full attention to flying, or made under conditions such as a landing approach, where the pilot necessarily devotes nearly all of his time to flying the airplane, will show that the minimum tolerable time to double amplitude is very low. However, there are many circumstances where the pilot does not, and indeed, cannot devote all of his attention to flying the airplane. He must read maps, work navigation problems, consult radio facilities handbooks, or route manuals, tune radios, and carry on various other activities. It is impossible for him to handle these tasks effectively if, every time he diverts his attention, the airplane starts spiraling off. It is perfectly reasonable, then, for pilots to find an airplane with a rapid spiral divergence perfectly flyable yet absolutely intolerable.

MIL-STD-1797A
APPENDIX A

In NADC-ED-6282, a limit of $T_{1/2} > 10$ seconds on the degree of spiral stability was recommended primarily from consideration of Cornell Aero Lab TB-1094-F-1 and WADC-TR-59-135. TB-1094-F-1 stated that "the maximum desired spiral stability appears to be a time to half amplitude of 10 seconds." Based on closed-loop analysis, WADC-TR-59-135 suggested that $T_{1/2}$ less than approximately 7 to 14 seconds would generally cause a degradation of pilot opinion. If the experimental in-flight data of TB-574-F-6 (figure 148) and TB-1094-F-1 (figure 149) are examined, however, it can be seen that good pilot ratings are obtained for $T_{1/2} = 10$ seconds and that the flying qualities do not begin to degrade appreciably until $T_{1/2} = 5$ seconds.

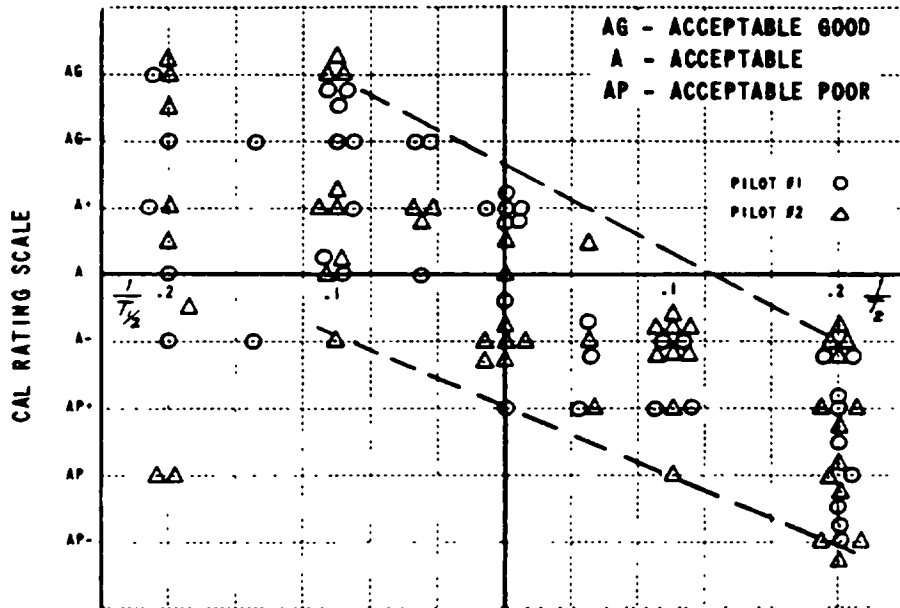

Figure 149. Data for all types of flying pilot opinion versus spiral damping (from Cornell Aero Lab TB-1094-F-1).

Although there are some data that indicate there should be some limit on the degree of positive spiral stability, other data show that strong positive spiral stability can be beneficial. For example, in the program described in Cornell Aero Lab IH-2154-F-1, a wings-leveling device was installed in an aircraft that resulted in an effective highly convergent spiral. Although some pilots commented on the high forces required to hold the airplane in a turn, the flying qualities were considered to be quite acceptable and, in some respects, definitely preferable to neutral spiral stability.

For these reasons, it was decided not to recommend a requirement on positive T_s or $T_{1/2}$ at this time, but instead to recommend requirements on other factors associated with convergent spirals. That is, the limit on aileron forces in turns and the required roll maneuverability will effectively limit $T_{1/2}$.

It should be noted that the spiral requirements include the effect of lateral trim change with speed as well as the constant-speed spiral stability characteristics, since this is more representative of what the pilot sees than are constant-speed stability effects alone.

REQUIREMENT LESSONS LEARNED

This requirement is well established and the numbers come from operational experience, borne out by rough estimates of the lower limit of pilots' frequency range of active control.

5.5.1.2 Spiral stability-verification.

Verification shall be by analysis, simulation and flight test.

VERIFICATION RATIONALE (5.5.1.2)

Bearing in mind that friction and asymmetric loadings must be accounted for, no special flight test techniques are required.

VERIFICATION GUIDANCE

Because of the low frequency of the spiral mode its effects are easily masked by residual rolling moments, e.g., due to asymmetric loadings or control system friction. Additionally, if tests are conducted with the pitch control free, the resulting phugoid oscillation may alter the rate of spiral divergence. Values of equivalent spiral time constant can be obtained from the equivalent system fit of the p/F_{as} response, described in 4.5.1.1 for the roll mode. To include the effect of airspeed though, would require simultaneously, considering the longitudinal degrees of freedom.

The classical spiral-mode time constant is approximately

$$\frac{1}{T_s} \approx \frac{g}{V} \left(\frac{C'_{\ell r} - C'_{nr} C'_{\ell \beta} / C'_{n\beta}}{C'_{\ell p} - (C'_{np} - 2k_z^2 C_{L1}) C'_{\ell \beta} / C'_{n\beta}} \right)$$

where quantities are as defined in guidance for 5.5.1.1.

VERIFICATION LESSONS LEARNED

The very low frequency typical of the spiral mode makes the spiral time constant difficult to measure by dynamic parameter identification techniques.

MIL-STD-1797A
APPENDIX A

4.5.1.3 Coupled roll-spiral oscillation.

A coupled roll-spiral mode will be permitted only if it has the following characteristics: _____.

REQUIREMENT RATIONALE(4.5.1.3)

Existence of a coupled roll-spiral oscillation (also called, a lateral phugoid) results in poor bank angle control and excessive lateral stability for maneuvering flight. However, for rather benign flight conditions as in conventional approach and landing, some roll attitude (or integral of $p dt$) stabilization has been found helpful. The requirement prohibits the degree of coupling which has been found deleterious.

REQUIREMENT GUIDANCE

The related MIL-F-8785C requirement is paragraph 3.3.1.4.

The primary objections to a coupled roll-spiral mode are the lack of roll control effectiveness and high steady forces (more or less proportional to bank angle) in turning flight (see AFFDL-TR-72-41, page 138). Roll-spiral coupling can arise from unusual values of L'_β , L'_p , N'_p and N'_r , or from augmentation which employs bank angle feedback (see Aircraft Dynamics and Automatic Control). Experience with bank angle command systems has shown that in order to obtain reasonable control sensitivities, the control authority must be very low. One source of the experience was a V/STOL control system blending study conducted on a moving-base simulator (NADC-77052-30). In that study it was clear that while a bank angle command system was desirable in hover, it was also desirable to switch to a rate command system at very low airspeeds. As with the AFFDL-TR-72-41 comments, the pilots found that the lack of roll control authority and high steady forces in the turns were unacceptable. For hands-off steady flight, some autopilots use a wings-leveler to good effect.

In cases where the coupled roll spiral results from unusually large values of L'_β , N'_p/L'_p and N'_r , a low L'_p may result in controllability problems. This was the case for the M2-F2 lifting body (NASA-TN-D-6496).

The values in table XXVI were taken directly from MIL-F-8785C.

TABLE XXVI. Recommended minimum values for roll-spiral damping coefficient, $\zeta_{RS} \omega_{RS}$

LEVEL	CATEGORY A	CATEGORIES B AND C**
1	*	0.5
2	*	0.3
3	*	0.15

* The aircraft shall not exhibit a coupled roll-spiral mode in Category A Flight Phases.

** The aircraft shall not exhibit a coupled roll-spiral oscillation in Category C Flight Phases requiring rapid turning maneuvers such as short approaches.

SUPPORTING DATA

NASA-CR-778, AFFDL-TR-65-39, and NASA-TN-D-5466 contain results of simulations involving coupled roll-spiral modes. In all cases the longitudinal characteristics of the baseline vehicle were rated Level 1 by the evaluation pilots. In addition, all lateral phugoid cases were characteristic of lifting bodies: large effective dihedral, low roll damping, and positive yaw acceleration due to roll rate.

MIL-STD-1797A
APPENDIX A

The data of NASA-CR-778 are for an in-flight simulation of a reentry vehicle using the Calspan variable-stability T-33. Figures 150, 151, and 152 present results of the simulation utilizing spiral descent and landing approach (figure 150) and up-and-away flight (figures 151 and 152) maneuvers. Four pilots evaluated the configurations, and inter-pilot variations in ratings were small for most cases. Figure 150 shows that in smooth air and slight proverse yaw due to ailerons, $(\omega_\phi/\omega_d)^2 = 1.344$, a lateral phugoid is acceptable but unsatisfactory (Ratings are based on the 10-point CAL scale). Ratings degrade quickly in turbulence, and as $(\omega_\phi/\omega_d)^2$ becomes much less than or greater than 1.0. Figure 152 shows poor ratings for all configurations; this may be due to the large value of $|\phi/\beta|_d$ (8.58). However, in general, in light or less turbulence and with low yaw due to ailerons, a lateral phugoid mode is not shown to be objectionable (note that for figures 151 and 152, ζ_d is Level 2 in value) for the tasks considered to be low-demand (Category B) in nature.

The ground simulation of NASA-TN-D-5466 involved cruise and low-speed conditions, including several ILS approaches. These also, with the exception of the ILS approaches, are Category-B-type maneuvers. However, the approach ratings were reported to correlate with the low-speed (general all-around flying) ratings, so all these could be considered to be Category C data. Results are shown on figure 153. The boundaries of table XXVI are shown for comparison. In general, though the dutch roll characteristics (ζ_d , ω_d , $|\phi/\beta|_d$) and adverse aileron yaw [$(\omega_\phi^2/\omega_d^2)$] are varied, the data show definite trends with ζ_{RS} and ω_{RS} . They are also in agreement with the in-flight data of figures 150-152, but they do not show strong support for the table XXVI boundaries. Instead, they indicate that something like the following minimum values of the product $\zeta_{RS} \omega_{RS}$ would be more appropriate:

Level 1: $\zeta_{RS} \omega_{RS} > 0.5$

Level 2: $\zeta_{RS} \omega_{RS} > 0.07$

Level 3: $\zeta_{RS} \omega_{RS} > 0.0$

Quantitatively, correlation with the boundaries would jump from about 15 percent to almost 80 percent. However, the lack of any pilot commentary, or of detailed descriptions of the piloting tasks, somewhat reduces the credibility of the data. In addition, AFFDL-TR-65-39 has data which disagrees entirely with both NASA-TN-D-5466 and NASA-CR-778.

The ground simulation of AFFDL-TR-65-39 shows a much more pessimistic view of the lateral phugoid (figure 154). Even the best of the configurations was rated no better than 5 (CAL scale), and almost all were unflyable (PR of 10). In this simulation both open- and closed-loop pilot tasks were included. The closed-loop maneuvers covered climbing, diving, and level turns and both slow and rapid entries into 30 deg and 60 deg banks. Both smooth and simulated rough air were used. The open-loop task required that the pilots copy a standard IFR clearance.

MIL-STD-1797A
APPENDIX A

It is not clear why the data of AFFDL-TR-65-39 differ so dramatically from both the ground simulation of NASA-TN-D-5466 and the flight data of NASA-CR-778⁷. It is possible that the high ratio of $|\phi/\beta|_d$ (ranging from 6.1 to 26.5) caused the degradation; from AFFDL-TR-65-39.

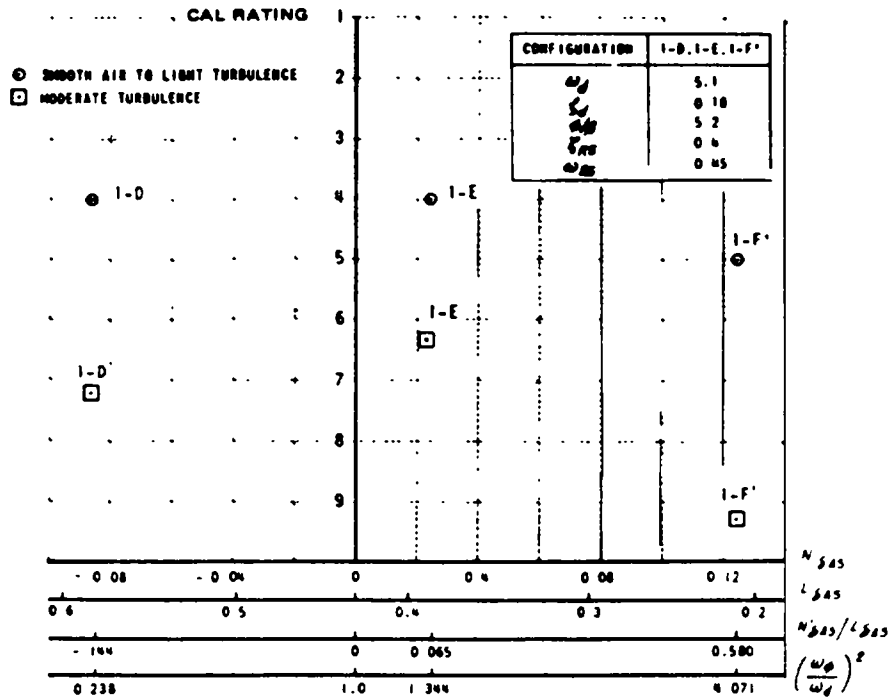

FIGURE 150. Composite pilot ratings for spiral descent of simulated reentry vehicle (from NASA-CR-778).

⁷ The data of AFFDL-TR-65-39 using real roll and spiral modes are also in disagreement with other such data, see figure 147.

MIL-STD-1797A
APPENDIX A

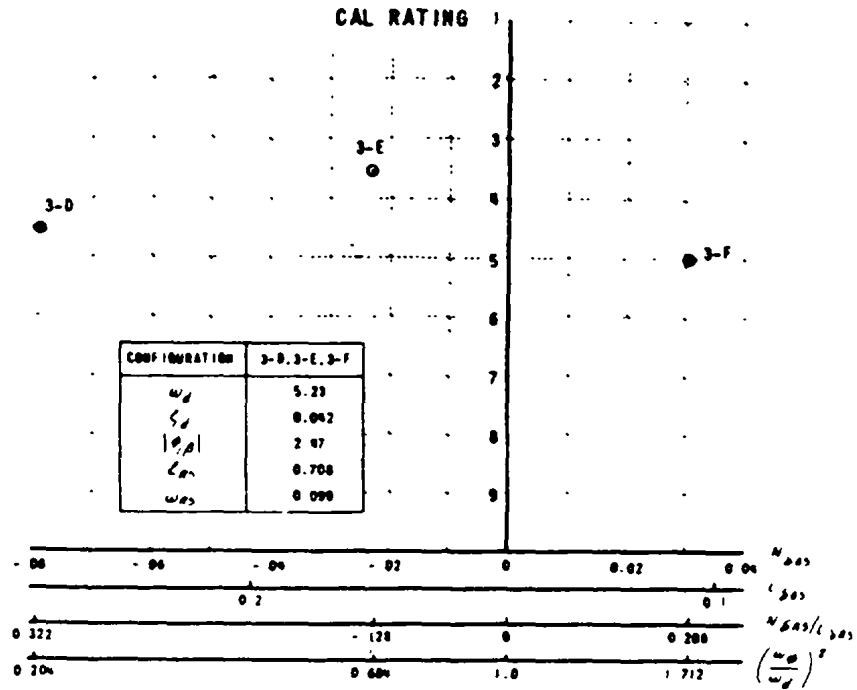

FIGURE 151. Composite pilot ratings for up-and-away flight; moderate $|\phi/\beta|_d$ (from NASA-CR-778).

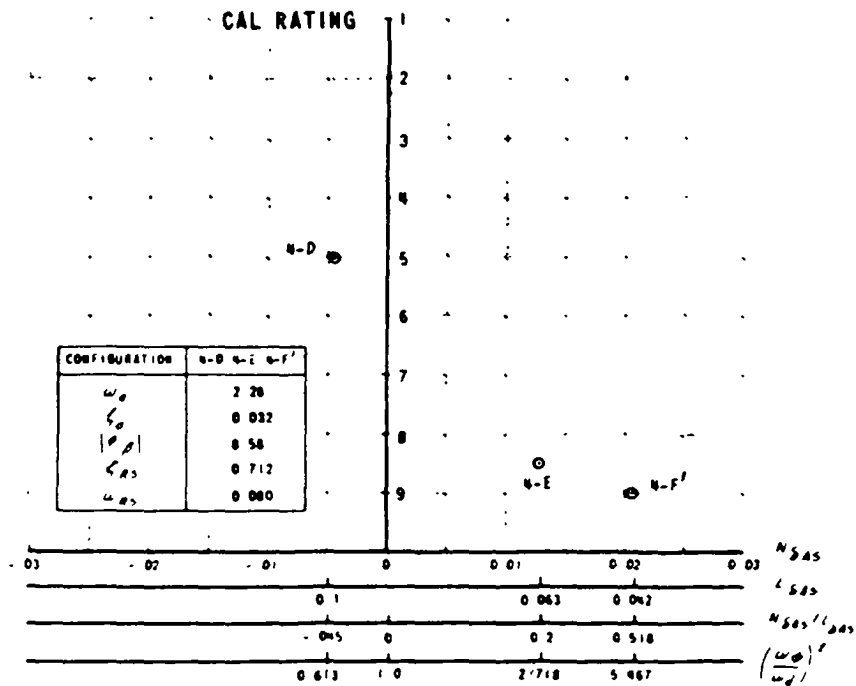

FIGURE 152. Composite pilot ratings for up-and-away flight; large $|\phi/\beta|_d$ (from NASA-CR-778).

MIL-STD-1797A
APPENDIX A

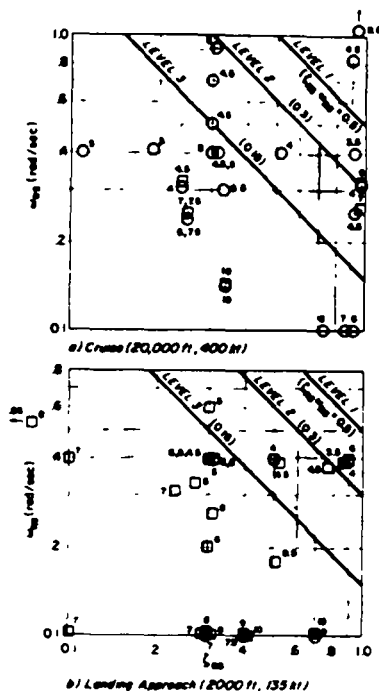

FIGURE 153. Pilot ratings for ground simulation of NASA-TN-D-5466 (Dutch roll characteristics vary).

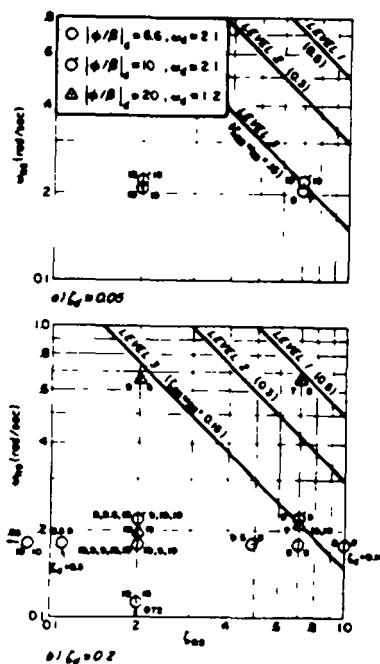

FIGURE 154. Pilot ratings for ground simulation of AFFDL-TR-65-39 $[(\omega_\phi/\omega_d)^2 = 0.64 - 1.10]$.

The most obvious conclusion is that the complex roll-spiral mode configurations that were investigated represent poor to very bad tactical aircraft, primarily because of the lack of roll damping and the resultant rolly characteristics.

MIL-STD-1797A
APPENDIX A

However, NASA-CR-778 also contains some high $|\phi/\beta|_d$ cases (figure 152), and for $(\omega_\phi/\omega_d)^2$ near 1 the average rating was 5 ($\zeta_{RS} \omega_{RS} = 0.057$). The details of the simulated turbulence used in AFFDL-TR-65-39 are not known; but it is possible that this had a major effect on the ratings (see figure 159 and AFFDL-TR-67-2).

REQUIREMENT LESSONS LEARNED

Experience with the M2-F2 lifting body (NASA-TN-D-6496) shows support for a strict requirement on the lateral phugoid, and illustrates the insidious nature of the lateral phugoid mode. Figure 155 shows the variation in ζ_{RS} and ω_{RS} for the unaugmented and augmented M2-F2. (In the actual vehicle, a second-order washout mode occurs, through p and r feedbacks, but it is near in frequency and damping to the lateral phugoid. Low-frequency washout zeros effectively cancel one of the modes so that the vehicle essentially behaves like a classical coupled roll-spiral configuration.) In gliding landing tests of the M2-F2, energy management required flight at negative angles of attack. On numerous flights the M2-F2 entered divergent lateral-directional oscillations which were stopped only by pulling back to positive angles of attack. The analysis of NASA-TN-D-6496 showed these oscillations to be due to the coupled roll-spiral mode. Time histories in NASA-TN-D-6496 suggest that the M2-F2 became uncontrollable at -2 deg angle of attack; this coincides (figure 155) with $\zeta_{RS}\omega_{RS} = 0$. Addition of a center fin (the M2-F3) improved primarily the yawing characteristics of the vehicle. As figure 155 shows, even at large negative angles of attack the M2-F3 lateral phugoid mode is still stable (in fact, the roll and spiral modes are uncoupled -- $\zeta > 1$ -- until $\alpha = 2$ deg). Flight tests of the M2-F3 (SAS on) supported the prediction of good lateral flying qualities at negative angles of attack.

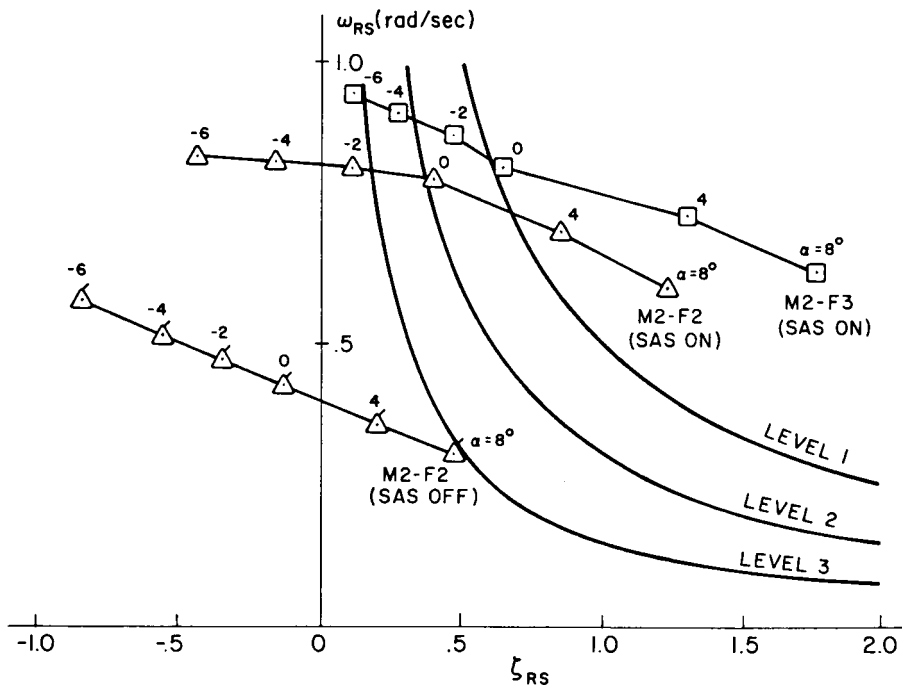

FIGURE 155. Coupled roll-spiral mode characteristics for M2-F2 and M2-F3 lifting bodies (from NASA-TN-D-6496).

5.5.1.3 Coupled roll-spiral oscillation-verification.

Verification shall be by analysis, simulation and flight test.

VERIFICATION RATIONALE (5.5.1.3)

Analysis based on wind tunnel estimates can predict potential areas in which a lateral phugoid might exist; flight testing should be concentrated in those regions. Starting from the complete lateral and directional transfer functions, it is straightforward to identify that the roll and spiral modes are coupled. That is, the two usual first-order terms in the denominator are combined into a second-order mode that identifies the roll-spiral damping.

Flight and simulator evaluation tasks should involve as rapid maneuvering as could be expected in the Flight Phase, in smooth and turbulent air.

VERIFICATION GUIDANCE

Existence of a coupled roll-spiral mode should be allowed only during those flight conditions which do not require rapid bank angle maneuvering.

$C_{l_\phi} = 0$:

$$\omega_{RS}^2 \approx \frac{\rho g^2}{4(W/S)k_x^2} \left(\frac{C'_{nr} C'_{l_\beta} / C'_{n_\beta} - C'_{l_r}}{1 - \frac{g \rho b k_z^2}{4(W/S)k_x^2} \left(C_{y_\beta} + \frac{C'_{nr}}{2k_z^2} \right) \frac{C'_{l_p}}{C'_{n_\beta}}} \right)$$

$$2\zeta_{RS}\omega_{RS} \approx \frac{\rho V g}{4(W/S)k_x^2} \left(\frac{-C'_{l_p} + (C'_{n_p} - 2k_z^2 C_{L1}) C'_{l_\beta} / C'_{n_\beta}}{1 - \frac{g \rho b k_z^2}{4(W/S)k_x^2} \left(C_{y_\beta} + \frac{C'_{nr}}{2k_z^2} \right) \frac{C'_{l_p}}{C'_{n_\beta}}} \right)$$

WADC-TR-58-82 gives as the usual condition for appearance of such a lateral phugoid:

$$\frac{L'_p N'_\beta / L'_\beta}{N'_p - g/V} \rightarrow 1$$

and the most common combination in that case to be positive N'_p larger than g/V , with relatively large L'_β .

$C_{l_\phi} = C_{l_{\delta_a}} K_{\phi_{\delta_a}}$, $\omega_\phi = \omega_d$, $\zeta_\phi = \zeta_d$:

In terms of T_R and T_S values for $K_{\phi_{\delta_a}} = 0$, when $\delta_a = K_{\phi_{\delta_a}} (\phi_c - \phi)$

MIL-STD-1797A
APPENDIX A

$$\begin{aligned}
 2\zeta_{RS}\omega_{RS} &\approx \left(\frac{1}{T_S} + \frac{1}{T_R} \right)_{K_{\phi\delta_a}=0} \approx \frac{1}{T_R} \Big|_{K_{\phi\delta_a}=0} \\
 &\approx \frac{-\rho g V}{4(W/S)k_x^2} \left[C'_{\ell p} - (C'_{n\dot{p}} - 2k_z^2 C_{L1}) C'_{\ell\beta} / C'_{n\dot{\beta}} \right] \\
 \omega_{RS}^2 &\approx \left(\frac{1}{T_S T_R} \right)_{K_{\phi\delta_a}=0} + K_{\phi\delta_a} L'_{\delta a} \\
 &\approx \frac{g K_{\phi\delta_a}}{k_x^2 b} \frac{C'_{L\delta a}}{C_{L1}} + \frac{(g/V)^2}{2k_x^2} (C'_{n\dot{r}} C'_{\ell\beta} / C'_{n\dot{\beta}} - C'_{\ell r})
 \end{aligned}$$

since then, in terms of T_S and T_R evaluated at $K_{\phi\delta_a} = 0$.

$$\begin{aligned}
 \frac{\phi}{\phi_c} &\approx \frac{K_{\phi\delta_a} L'_{\delta a}}{(s+1/T_S)(s+1/T_R)} \\
 &= \frac{K_{\phi\delta_a} L'_{\delta a}}{1 + \frac{K_{\phi\delta_a} L'_{\delta a}}{(s+1/T_S)(s+1/T_R)}} \\
 &= \frac{K_{\phi\delta_a} L'_{\delta a}}{s^2 + \left(\frac{1}{T_R} + \frac{1}{T_S} \right) s + \left(\frac{1}{T_R T_S} + K_{\phi\delta_a} L'_{\delta a} \right)}
 \end{aligned}$$

where augmented (by other than $\phi \rightarrow \delta_a$ feedback) values of the stability derivatives may be used, and

$$\begin{aligned}
 k_x^2 &= I_x / (mb^2), & k_z^2 &= I_z / (mb^2), \\
 C'_{\ell i} &= \frac{C_{\ell i} + C_{n\dot{i}} I_{xz} / I_z}{1 - I_{xz}^2 / (I_x I_z)} & C'_{n\dot{i}} &= \frac{C_{n\dot{i}} + C_{\ell i} I_{xz} / I_x}{1 - I_{xz}^2 / (I_x I_z)} \\
 C_{L1} &= W / (\bar{q} S)
 \end{aligned}$$

VERIFICATION LESSONS LEARNED

MIL-STD-1797A
APPENDIX A

4.5.1.4 Roll oscillations.

With yaw controls free, the response to roll control commands shall meet the following requirements:

REQUIREMENT RATIONALE (4.5.1.4)

This requirement is directed at precision of control of aircraft with moderate to high $|\phi/\beta|_d$ response ratios combined with marginally low dutch roll damping. Such aircraft exhibit a tendency to develop oscillations in roll rate both open- and closed-loop. This characteristic clearly interferes with the pilot's precision of control and should be kept to an absolute minimum for all but the most undemanding tasks. The requirement is stated in several forms in order to catch different magnitudes of control input and response.

REQUIREMENT GUIDANCE

The related MIL-F-8785C requirements are 3.3.2.2, 3.3.2.2.1 and 3.3.2.3.

Recommended values:

Following a step roll control command, the roll rate at the first minimum following the first peak shall be of the same sign and not less than the following percentage of the roll rate at the first peak:

LEVEL	FLIGHT PHASE CATEGORY	PERCENT
1	A & C	60
	B	25
2	A & C	5
	B	0

For step roll control commands up to the magnitude which causes a 60-degree bank angle change in 1.7 T_d seconds, the value of the parameter p_{osc}/p_{av} shall be within the limits shown on figure 156.

Following an impulse roll command as abrupt as practical within the strength limits of the pilot and the rate limits of the roll control system, the value of the parameter ϕ_{osc}/ϕ_{av} shall be within the limits shown on figure 157.

The existence of roll rate oscillations is directly traceable to the relative locations of the ω_ϕ and ω_d zeros in the p/F_{as} transfer function:

$$\frac{p}{F_{as}} = \frac{L_{F_{as}} s [s^2 + 2\zeta_\phi \omega_\phi s + \omega_\phi^2] e^{-\tau_\phi s}}{(s + 1/T_S)(s + 1/T_R) [s^2 + 2\zeta_d \omega_d s + \omega_d^2]}$$

When the complex roots cancel ($\omega_\phi = \omega_d$ and $\zeta_\phi = \zeta_d$), the dutch roll mode is not excited at all. When they do not cancel, the dutch roll contamination occurs primarily in yaw and sideslip if $|\phi/\beta|_d$ is low (say less than 1.5) or primarily in the roll axis when $|\phi/\beta|_d$ is large. As mentioned above, the P_{osc}/P_{av} parameter is directed at cases where $|\phi/\beta|_d$ is large and ζ_d is low. Note that for all Category A operations the suggested Level 1 value of ζ_d in 4.6.1.1 effectively eliminates the need for this requirement.

MIL-STD-1797A
APPENDIX A

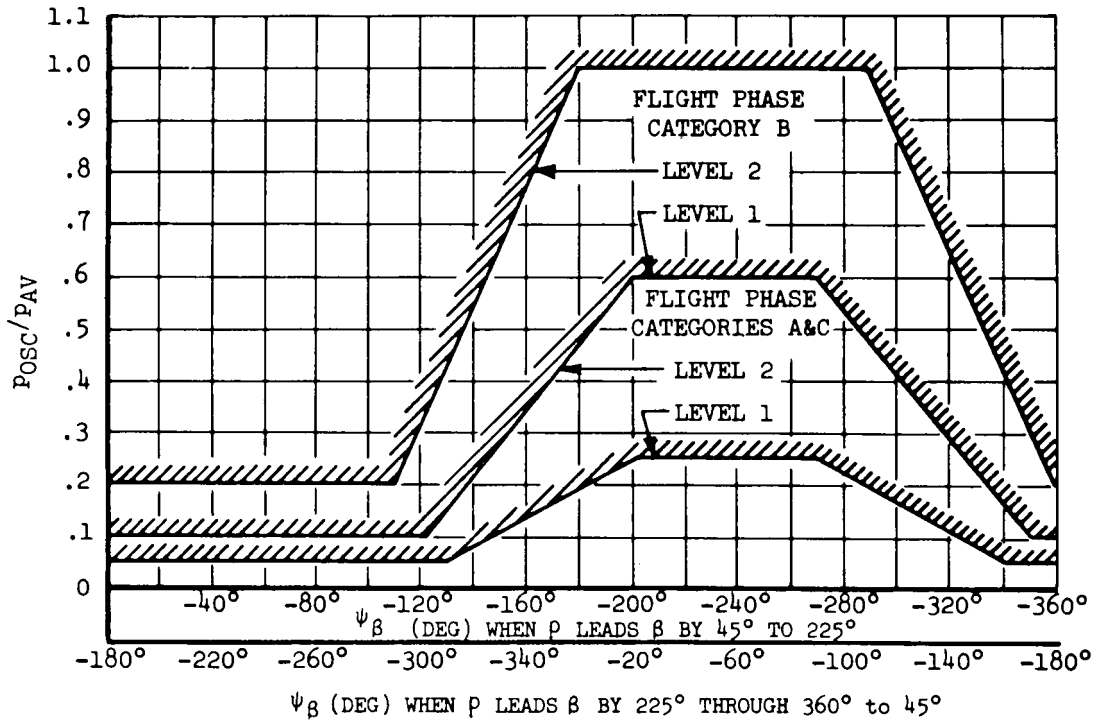

FIGURE 156. Roll rate oscillation limitations.

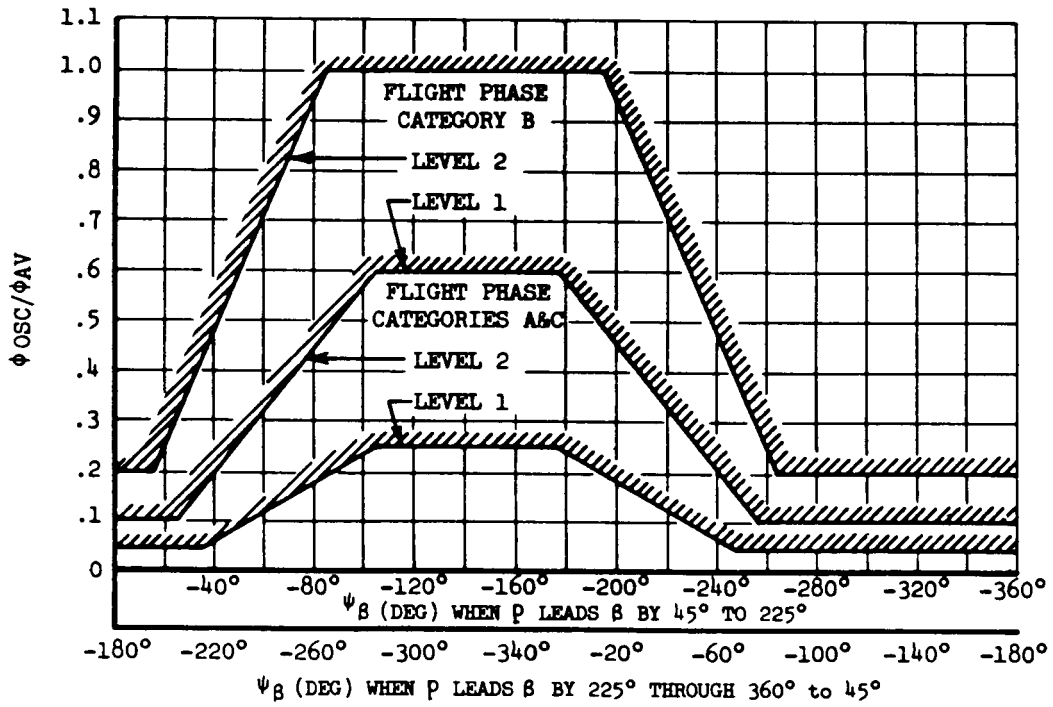

FIGURE 157. Bank angle oscillation limitations.

MIL-STD-1797A
APPENDIX A

An extensive description of the derivation of p_{osc}/p_{av} and ψ_β is given in AFFDL-TR-69-72, which should be consulted for further detail. p_{osc}/p_{av} is the ratio of the oscillatory component of roll rate to the average component of roll rate following a rudder-pedals-free step lateral control input. Examples of measurements of p_{osc}/p_{av} are given in the following. The parameter ψ_β is shown in AFFDL-TR-69-72 to be a measure of the relative location of the dutch roll pole and the ω_ϕ zero. It defines the phasing of the dutch roll component of the sideslip response following a step lateral control input, i.e.,

$$\frac{\beta_d}{F_{as}} = C_d e^{-\zeta_d \omega_d t} \cos(\omega_d \sqrt{1-\zeta_d^2} t + \varphi_\beta)$$

This is illustrated graphically in the sketch below (from AFFDL-TR-69-72).

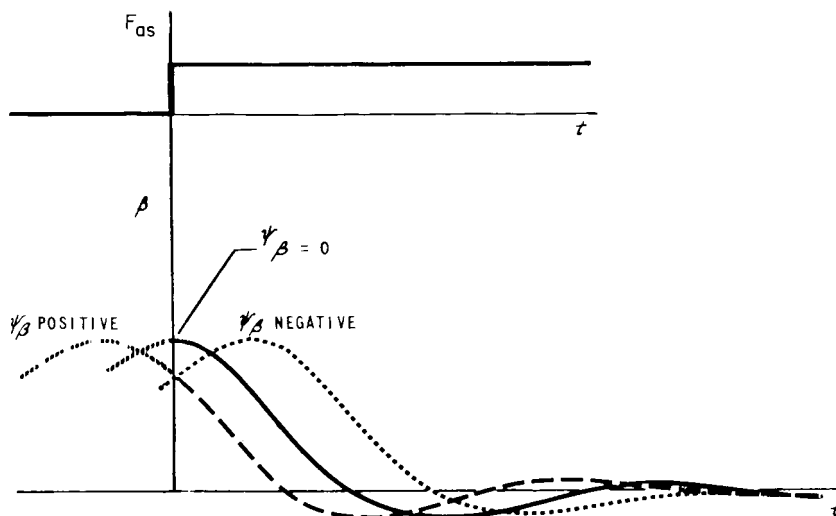

The parameters p_{osc}/p_{av} and ψ_β have been used to specify the criterion as a function of Flight Phase Category and Level (figure 156). It should be noted that figure 156 has two ψ_β scales, one for positive dihedral (p leads β by 45 deg to 225 deg) and the other for negative dihedral (p leads β by 225 deg through 360 deg to 45 deg). Dihedral as used in flying qualities work seems to be an ambiguous and sometimes ill-defined parameter. Here the term refers to the phasing of roll and sideslip motion in the dutch roll mode, $\angle p/\beta$. With positive dihedral, in the dutch roll oscillation left rolling accompanies right sideslipping and vice versa. In this context, positive dihedral normally means negative $L'_\beta + Y_v L'_r \doteq L'_\beta$, where

$$L'_\beta = \frac{\Delta L_\beta + N_\beta I_{xz}/I_x}{1 - I_{xz}^2/(I_x I_z)}$$

This is the expected result of positive geometric dihedral, hence the use of the term.

Since ψ_β (the phase angle in a cosine representation of the dutch roll component of sideslip, negative for a lag) is a rather abstract parameter, it is well to consider its physical implications and significance to the

MIL-STD-1797A
APPENDIX A

piloting of an aircraft. Very simply, ψ_β together with $\angle p/\beta$ indicates the oscillatory roll phasing in response to roll commands. From figure 156 it can be seen that the ratio of roll rate oscillation to steady-state roll rate is allowed to be much greater for some values of ψ_β than for others. Specifically, the limits of p_{osc}/p_{av} for $0 \geq \psi_\beta \geq -90$ deg are far more stringent than for -180 deg $\geq \psi_\beta > -270$ deg. There are at least two reasons why this is so:

- a) Differences in closed-loop stability in piloted control
- b) Differences in average roll rate.

From the root locus analysis in figure 158a it can be shown that when the zero of the p/F_{as} transfer function lies in the lower quadrant with respect to the dutch roll pole (which results in -180 deg $\geq \psi_\beta \geq -270$ deg), the closed-loop damping increases when the pilot closes a bank angle error to aileron loop. Conversely, it can be shown that when the zero lies in the upper quadrant with respect to the dutch roll pole ($0 \geq \psi_\beta \geq -90$ deg), the closed-loop damping decreases when the pilot applies aileron inputs proportional to bank angle error (figure 158b). In this case a pilot's tolerance of p_{osc}/p_{av} tends to decrease. Finally, when ζ_d becomes large the effect of the pole-zero location is diminished (figure 158c), i.e., the variation in damping due to ω_ϕ/ω_d effect is small relative to ζ_d .

The connection between pole/zero location and the p_{osc}/p_{av} boundaries is shown in figure 159, where the Level 1 and Level 2 boundaries in figure 156 are mapped into ω_ϕ zero locations for several values of ω_d and ζ_d . Note that when ζ_d meets the Level 1 requirement ($\zeta_d > 0.19$) the acceptable region for ω_ϕ is very large in the region to the left of and below ω_d . However, there is always a low tolerance for $\omega_\phi > \omega_d$ because the closed-loop damping decreases. There is still a relatively tight limit on $\omega_\phi > \omega_d$ for ζ_d of 0.25. This of course reflects the decrease in damping that occurs ($\zeta_d = 0.25$ is not much greater than the Level 1 limit of 0.19). An important aspect of the p_{osc}/p_{av} requirement is that it implicitly accounts for the allowable increase in the region of allowable ω_ϕ as ζ_d and ω_d increase.

An alternative method of specifying roll rate oscillations, recommended by Calspan (AFFDL-TR-72-41), was considered. The proposed revision would involve extracting the effect of the spiral mode, T_S , from the roll rate response. This would get rid of the present significant effect T_S can have on p_{osc}/p_{av} , as shown in figure 160. A new parameter, \hat{p}_{osc}/\hat{p}_1 , would be used, where the hat (^) represents the spiral-less roll rate response. Then $\hat{p}_{osc}/\hat{p}_1 = (\hat{p}_1 + \hat{p}_3 - 2\hat{p}_2/2\hat{p}_1)$. AFFDL-TR-72-41 also recommended that the parameter ψ_β be replaced with ψ_p , i.e., the phase of the roll rate response.

Data comparisons with the AFFDL-TR-72-41 \hat{p}_{osc}/\hat{p}_1 , vs ψ_p and p_{osc}/p_{av} vs ψ_β do not justify any change at this time. For example, the Category A data of AFFDL-TR-67-98 show only a 40 percent correlation with the AFFDL-TR-72-41 limits, and 61 percent correlation with figure 156; the Category C data of AFFDL-TR-70-145 have exactly the same correlation with both criteria, 72 percent. Overall, only about half the data used in AFFDL-TR-72-41 to support \hat{p}_{osc}/\hat{p}_1 , agree with the proposed requirement. This was not felt to be sufficient to justify a change.

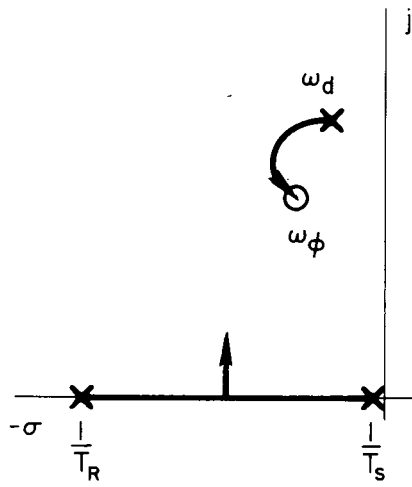
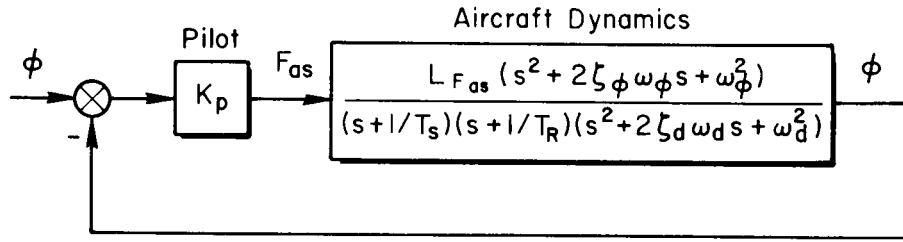

a) Low ζ_d ; Zero Below Pole

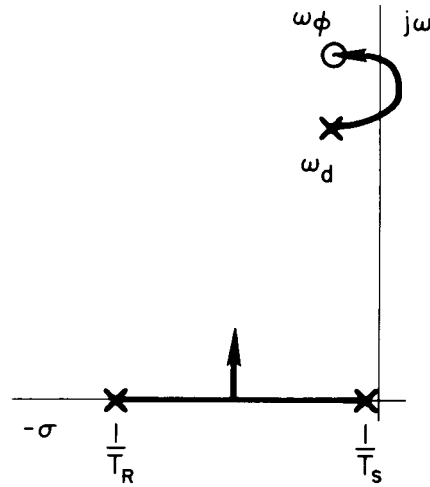

b) Low ζ_d ; Zero Above Pole

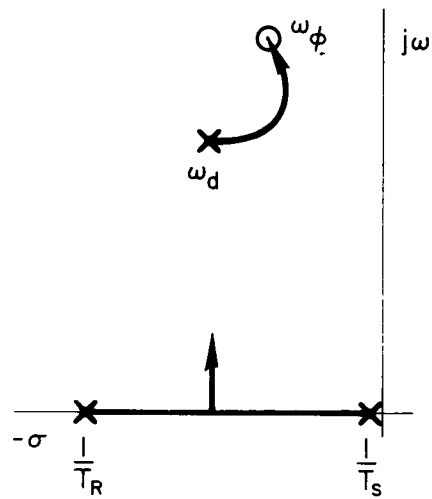

c) Moderate ζ_d ; Zero Above Pole

FIGURE 158. Effect of relative pole/zero location on piloted control of bank angle.

MIL-STD-1797A
APPENDIX A

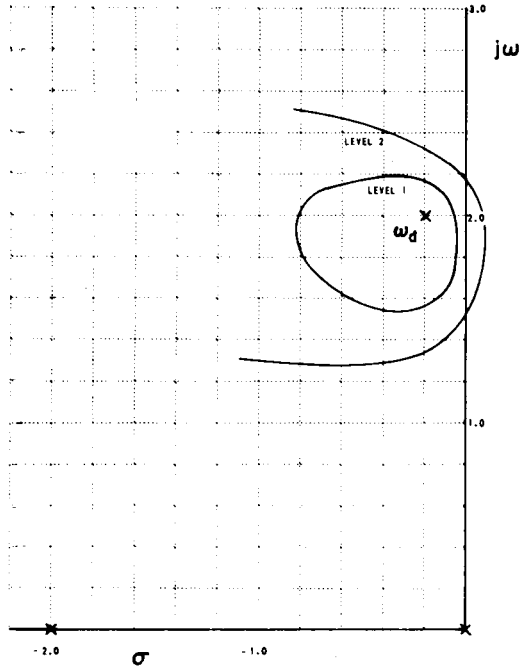

a) $\omega_d = 2 \text{ rad/sec}$; $\zeta_d = 0.1$

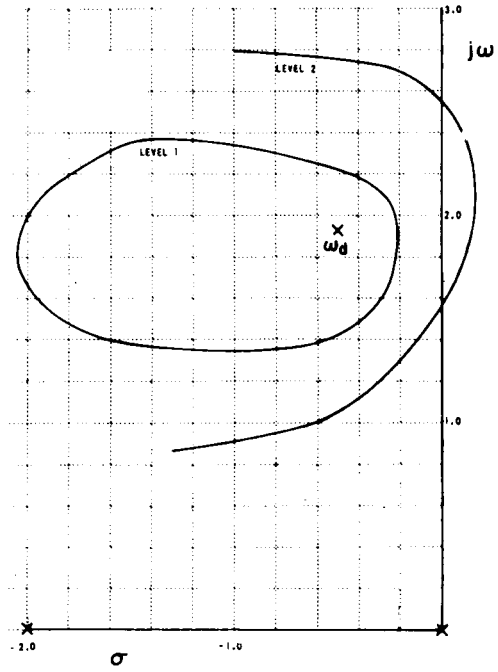

b) $\omega_d = 2 \text{ rad/sec}$; $\zeta_d = 0.25$

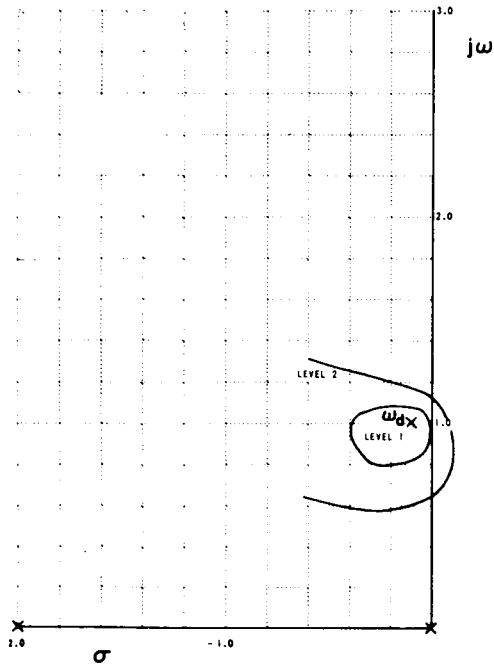

c) $\omega_d = 1.0 \text{ rad/sec}$; $\zeta_d = 0.1$

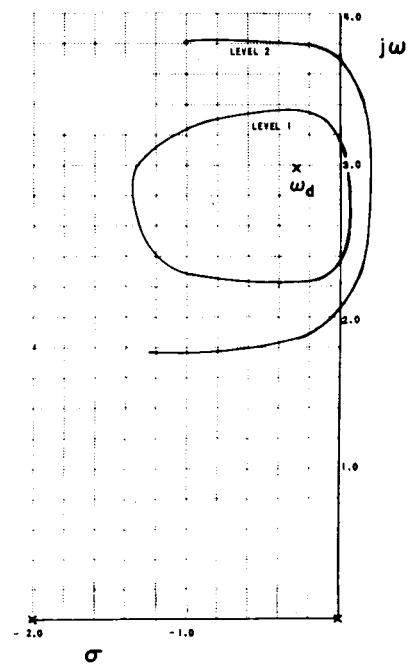

d) $\omega_d = 3.0 \text{ rad/sec}$; $\zeta_d = 0.1$

FIGURE 159. Locations of ω_{ϕ} , zero corresponding to Category A and C and Level 1 and 2 boundaries on figure 156 ($T_R = 0.5 \text{ sec}$, $T_S = \infty$) (from AFFDL-TR-69-72).

MIL-STD-1797A
APPENDIX A

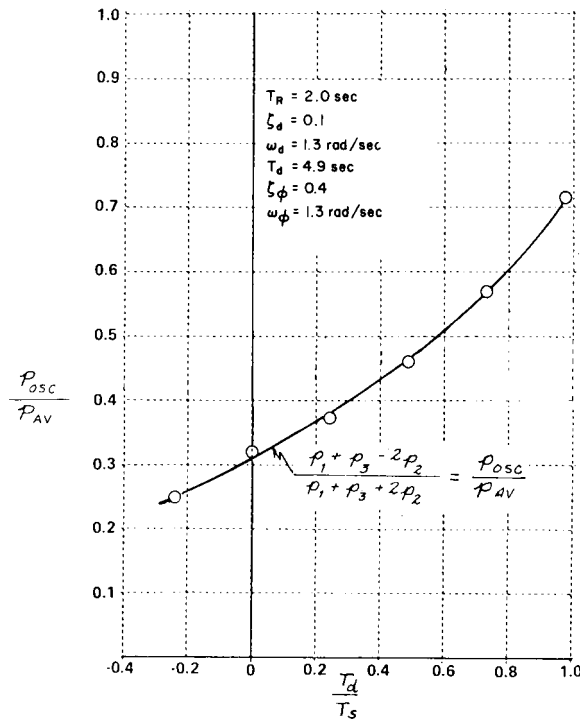

FIGURE 160. p_{osc}/p_{av} , as a function of the ratio of dutch roll period and spiral root time constant (from AFFDL-TR-72-41).

For design, this requirement is intended to define areas of acceptable pole-zero locations for the ϕ/F_{as} transfer function. Review of the derivation and data base for the requirement has resulted in several guidelines and qualifications to be considered in interpreting the requirement.

The roll, spiral and dutch roll mode requirements (4.5.1.1, 4.5.1.2, and 4.6.1.1) should first be met. If T_S is very small, the requirement may result in misleading values of p_{osc}/p_{av} (e.g., figure 160).

For aircraft with very small L'_β and very large L'_r (AFFDL-TR-71-164), $\angle p/\beta|_d$ can be between 180 deg and 270 deg. As shown in AFFDL-TR-69-72, this condition is not adequately included in the approximations used to define ψ_β . This leaves some doubt as to the significance of p_{osc}/p_{av} for such data.⁸

If $|\phi/\beta|_d$ is small (generally less than about 1.5), p_{osc}/p_{av} will be small and the requirement may not add any new information. Then 4.6.2 can be a very demanding requirement.

The requirement is of most value when ζ_d is near the Level 1 boundary (0.1-0.2). For greater ζ_d , p_{osc}/p_{av} is inherently small; for less ζ_d , the handling deterioration will be indicated by failing outside the ζ_d boundary.

⁸ The test results of AFFDL-TR-71-164 are not included in this report since the simulated airplane had Level 2 pitch characteristics which could have influenced pilot ratings. However, the peculiar problems encountered in measuring $\angle p/\beta$ are still of interest.

MIL-STD-1797A
APPENDIX A

SUPPORTING DATA

The most complete set of Category A supporting data (figures 161 and 162), from flight tests of AFFDL-TR-67-98 using the variable-stability T-33, shows conflicting results. The data of figure 161, for moderate $|\phi/\beta|_d$ ratios, agree quite well with the boundaries. Likewise, the figure 162 high- $|\phi/\beta|_d$ points correlate, but all these data are rated Level 2 or 3, including the single point that falls in the Level 1 region. However, the cases for low $|\phi/\beta|_d$ (1.5) in figure 162 show extremely poor correlation. The reasons for this have not been resolved, though pilot comments indicate that the pilot was sensitive to the amounts of adverse aileron yaw included in many of the low $|\phi/\beta|_d$ cases. But even when there was no adverse aileron yaw the ratings were still generally very poor.

The Category B data (figures 163 and 164) show good correlation, but there are really only about ten data points with which to evaluate the Levels 2 and 3 regions (that is, data for which p_{osc}/p_{av} is large). Likewise, the Category C Levels 2 and 3 boundary (figure 165) is not well defined by the data.

Similar data (AFFDL-TR-70-145) show support for the requirements (figure 166). Again, this is Category C data, though the test programs of Princeton Univ Rpt 727 and AFFDL-TR-70-145 were for approach and waveoff only and hence did not include landing. Pilot ratings might be slightly worse if landings had been required. In their favor, however, both tests did include artificial turbulence (and, for AFFDL-TR-70-145, simulated crosswinds) which would be expected to increase pilot workload.

The thorough test matrix of AFFDL-TR-70-145 produced an abundance of data with which to draw some guidance for applying p_{osc}/p_{av} :

4.5.1.4 need not be applied if $|\phi/\beta|_d$ is small (from figure 166, $|\phi/\beta|_d < 1.5$ generally produces good ratings and low p_{osc}/p_{av} ; though the ratings of figure 162 for $|\phi/\beta|_d = 1.5$ are poor, p_{osc}/p_{av} is low).

The criterion is most useful when ζ_d , ω_d , $\zeta_d\omega_d$ or T_R is near the Level 1 - 2 limit. For example, there are 21 cases on figure 166 with $\zeta_d = 0.3$ (where the Level 1 limit is 0.08), only one of which is predicted to be significantly worse than Level 1. Actually, five of the 21 are rated worse than Level 1, but only one is worse than PR = 4 ($p_{osc}/p_{av} = 4.2$, $\psi_\beta = -180$ deg, PR = 8).

Since almost no data exist on strong roll-sideslip coupling with negative dihedral, it was necessary to specify the negative-dihedral requirement through analogy with the positive-dihedral requirements previously, described. Princeton Univ Rpt 604 did provide some data, however, which are presented in figure 167 for comparison with the roll rate oscillation requirement. The program of Princeton Univ Rpt 604 investigated lateral-directional instabilities relating to the X-15. In the course of this investigation, configurations were simulated either in flight or in a fixed-base simulator, or in both, that had:

MIL-STD-1797A
APPENDIX A

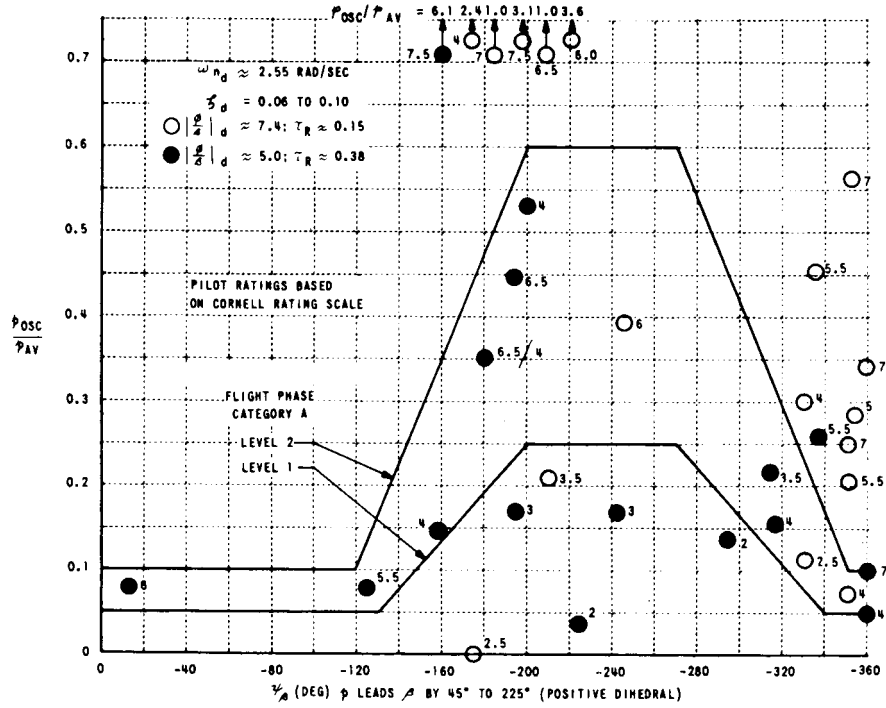

FIGURE 161. Flight phase Category A data, moderate $|\phi/\beta|_d$ (from AFFDL-TR-67-98).

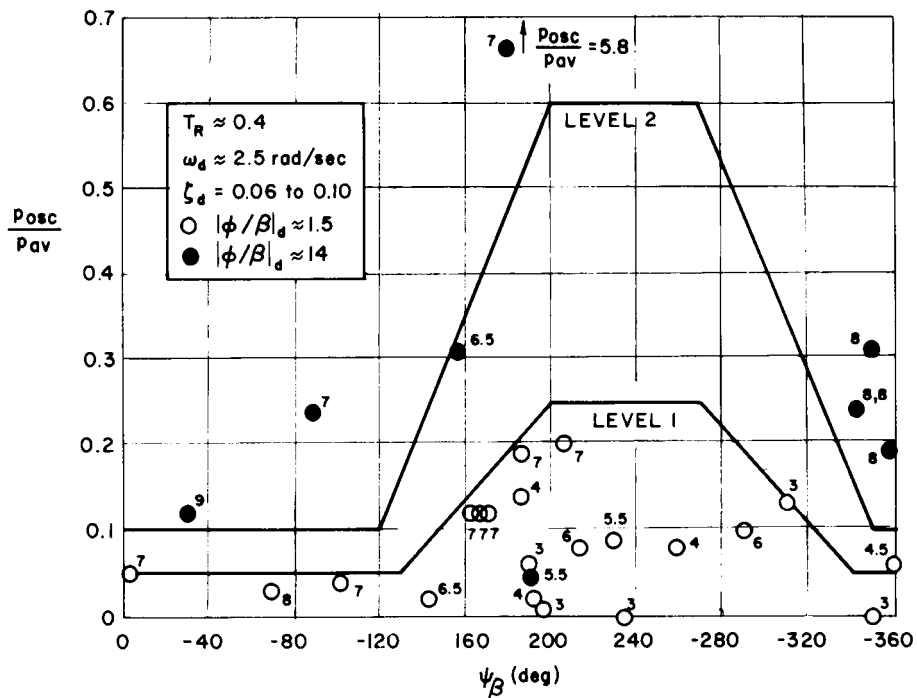

FIGURE 162. Flight phase Category A data, large and small $|\phi/\beta|_d$ (from AFFDL-TR-67-98).

MIL-STD-1797A
APPENDIX A

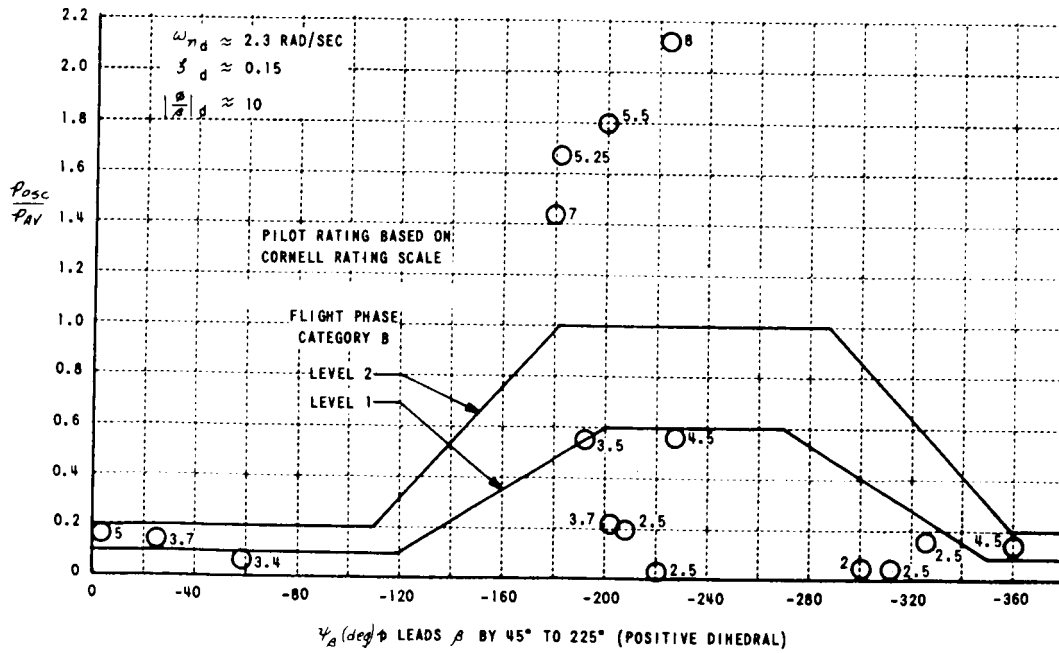

FIGURE 163. Flight phase Category B data (from NASA-CR-778).

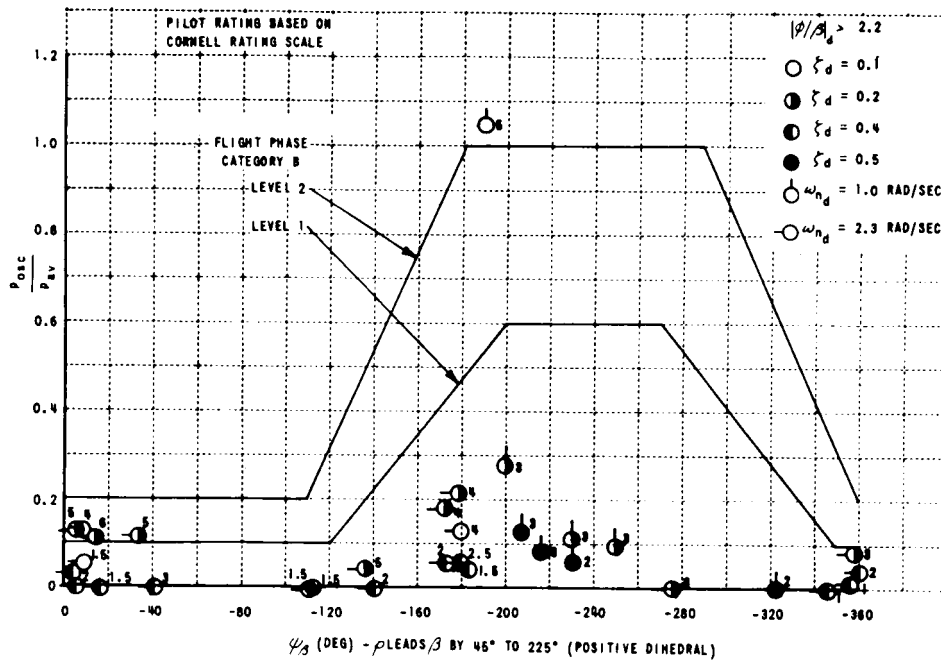

FIGURE 164. Flight phase Category B data (from WADD-TR-61-147).

MIL-STD-1797A
APPENDIX A

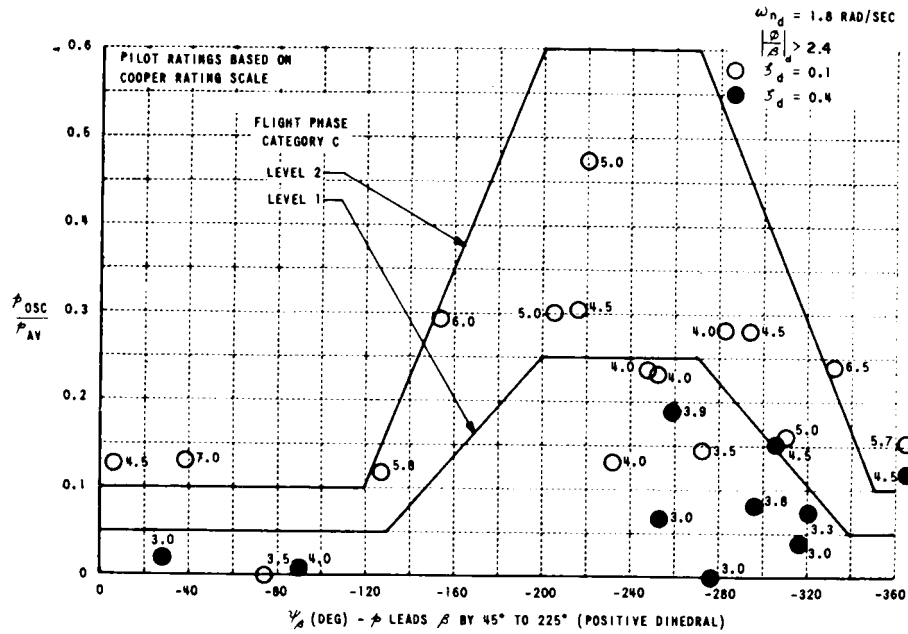

FIGURE 165. Flight phase Category C data (from Princeton Univ Rpt 727).

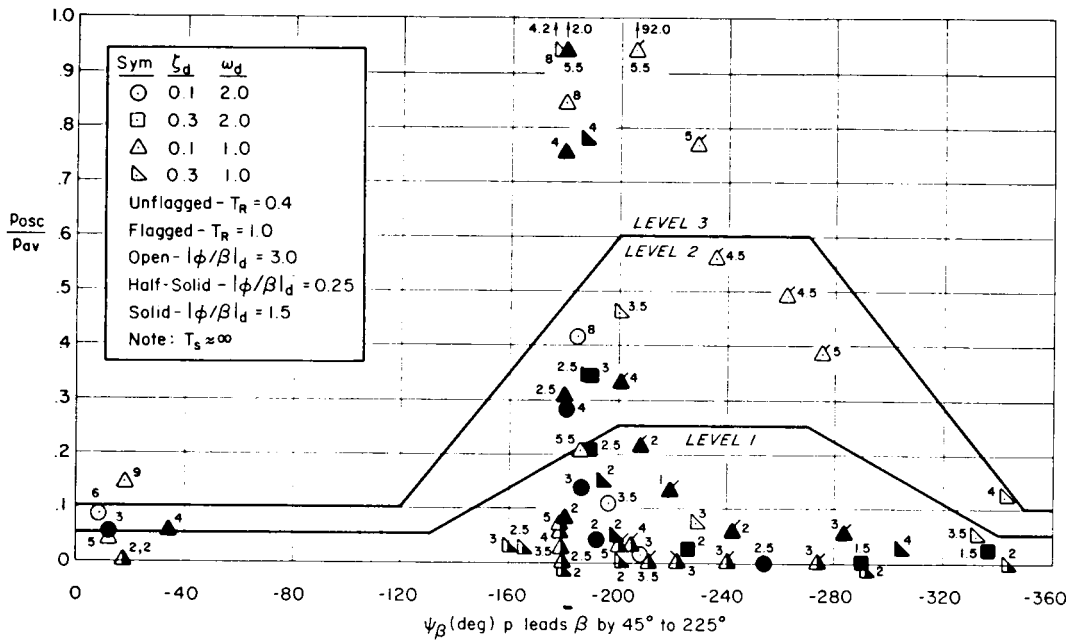

FIGURE 166. Category C data (approach and wave-off); Cooper-Harper pilot ratings (from AFFDL-TR-70-145).

MIL-STD-1797A
APPENDIX A

- a) Positive dihedral, proverse yaw due to aileron.
- b) Positive dihedral, adverse yaw due to aileron.
- c) Negative dihedral, proverse yaw due to aileron.
- d) Negative dihedral, adverse yaw due to aileron.

These configurations, which all had very light dutch roll damping and large $|\phi/\beta|_d$ response ratios, are plotted on figure 167. The parameters p_{osc}/p_{av} , and $\angle p/\beta$ were obtained from time histories of the responses to step aileron inputs. Configuration a, which falls well outside the Level 2 boundary of figure 167, was uncontrollable, attempts by the pilot to control the oscillation resulted in excursions of increasing magnitude for both sideslip angle and the roll rate.

Configuration b, which also falls well outside the Level 2 boundary of figure 167, was unacceptable because of the oscillatory response. However, it is significant that the pilot was able to control the aircraft, and, in fact, damp the oscillations when they occurred using only normal aileron control movements.

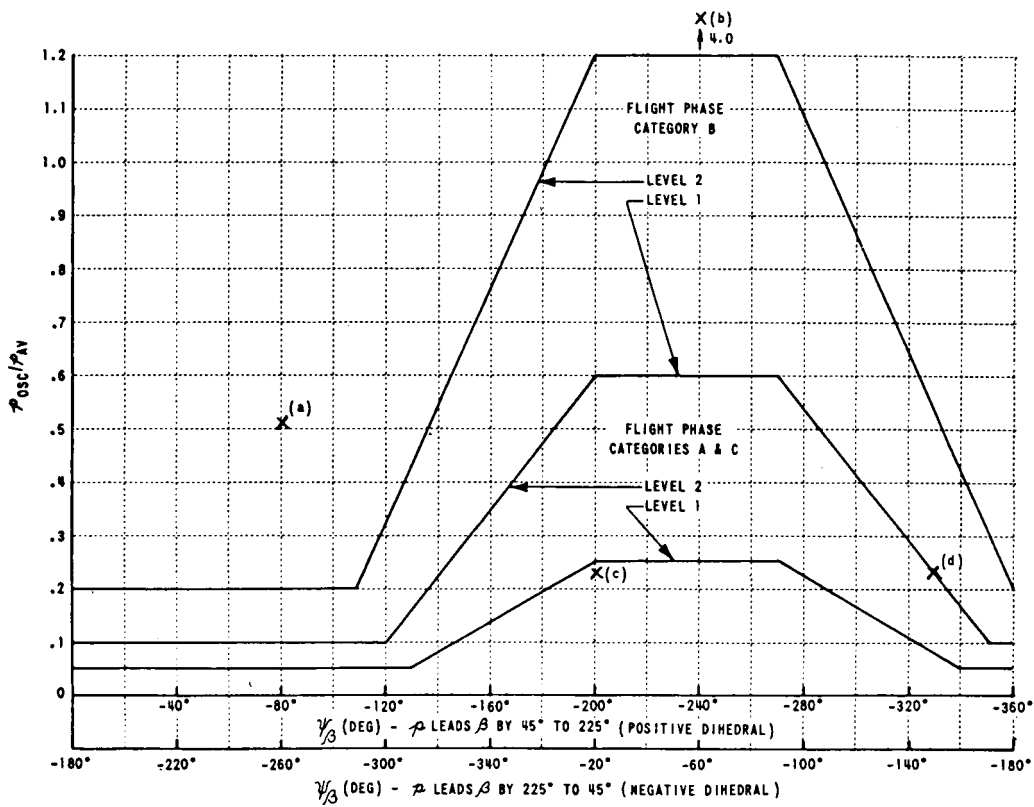

FIGURE 167. Positive and negative dihedral data of Princeton Univ Rpt 604.

Configuration c, which marginally falls in the good area of figure 167, was controllable and it was found that attempts to control the roll angle in a normal manner also helped to reduce the excursions of the sideslip angle.

Configuration d, which falls in an area of marginal acceptability on figure 167, was uncontrollable because of pilot-induced oscillations.

MIL-STD-1797A
APPENDIX A

Thus, with the possible exception of Configuration d, the pilot comments pertaining to the configurations were compatible with those expected from their roll-sideslip coupling characteristics as indicated by figure 167. Although Configuration d was rated worse than would be expected from the measured roll-sideslip coupling characteristics, the fact that the point fell in the region of figure 167 where the amount of allowable roll rate oscillation changes rapidly with ψ_β would indicate that the flying qualities of the configuration are sensitive to small changes in ψ_β . For example, if ψ_β were only 30 degrees greater (or if the peaks on the time histories presented differed by only 0.2 seconds from those of the configuration flown), the roll-sideslip coupling characteristics as indicated by figure 167 could be completely compatible with the pilot comments.

REQUIREMENT LESSONS LEARNED

As the following data reflects, correspondence with users of MIL-F-8785B and MIL-F-8785C shows that the requirements for roll rate and bank angle oscillations (paragraphs 3.3.2.2, 3.3.2.2.1, and 3.3.2.3 of MIL-F-8785B) have been generally ignored for current airplanes. It is hoped that the rationale presented in this document will aid the understanding of the intent. Roll control involves both fine tracking about neutral stick deflection and quick, accurate checking of high roll rate to stop accurately at a desired bank angle. Both control nonlinearities and gravitational/inertial nonlinearities can cause the characteristics to vary with control deflection or aircraft orientation in roll.

ASD COMMENTS ON MIL-F-8785B PARA. 3.3.2. LATERAL-DIRECTIONAL DYNAMIC RESPONSE CHARACTERISTICS

F- 16	Paragraphs 3.3.2.1, 3.3.2.2, 3.3.2.2.1, and 3.3.2.3 were deleted in F-16 spec. These requirements were assessed to be based on a questionable data base and have historically been difficult to verify from flight test data.
F-15, F-16, C-141	Paragraphs 3.3.2.2.1 (p_{osc}/p_{av}) and 3.3.2.3 (ϕ_{osc}/ϕ_{av}) should not be a problem if 3.3.1.1 ($\zeta_d \omega_d$) is set at sufficient value; these paragraphs add little to evaluation of F-15.
AMST, B-1	Paragraph 3.3.2.2 values seem too low based on DC-10 and B-1 data; paragraphs 3.3.2.2.1 and 3.3.2.3 are redundant and only 3.3.2.3 should be retained.

Paragraph 3.3.2.2 of MIL-F-8785C sets limits on roll at the first minimum following the first peak in response to a step roll control input. That and p_{osc}/p_{av} are directly related, since (from AFFDL-TR-69-72):

The numerical values of the roll rates specified in 3.3.2.2 were transformed from the values of p_{osc}/p_{av} for adverse yaw in 3.3.2.2.1. Thus, the requirements of 3.3.2.2 and 3.3.2.2.1 are essentially identical for aircraft with adverse yaw. However, the requirement of 3.3.2.2 is far more lenient than the requirement of 3.3.2.2.1 for aircraft with proverse yaw.

Likewise, a requirement based on ϕ_{osc}/ϕ_{av} and ψ_β (3.3.2.3 of MIL-F-8785C) would be expected to give results similar to p_{osc}/p_{av} . The several forms of this requirement have been retained:

- For selection of the easiest form to measure
- To account for both small step and large pulse inputs
- To handle flight control system nonlinearities, as in the F-16
- To handle hands-on/hands-off differences in mechanization of stabilization, as in the F-4

5.5.1.4 Roll oscillations-verification.

Verification shall be by analysis, simulation and flight test.

VERIFICATION RATIONALE (5.5.1.4)

The type(s) of maneuver to be considered will depend upon flight control system mechanization and, to an extent, on the degree of maneuverability required. The more detailed forms of the requirement are based on a linear model of the aircraft response, and so are valid only for motions which are well described by transfer functions. To the extent that a particular approximation holds, it may be stipulated that showing compliance with one of those requirements adequately shows compliance with the rest.

It should be noted that the value, or even the sign, of L'_β cannot always be determined from steady rudder-pedal-induced sideslips. Not only are product of inertia effects absent in steady sideslips, but also the control surface deflections are affected by control cross-coupling aerodynamically and through the flight control system.

VERIFICATION GUIDANCE

Closest scrutiny should be given those flight conditions where the roll or dutch roll characteristics are marginally acceptable (i.e., on the boundary between Levels 1 and 2). In any case, consideration should be given to testing at the maximum operational altitude, over the range of service speeds. Data suitable for determining the critical conditions should be available from analysis and testing of roll performance (5.5.8.1). As has been indicated, for small $|\phi/\beta|_d$ this requirement will generally not be as important as the limitation on oscillatory sideslip (4.6.2).

The parameters p_{osc}/p_{av} and ψ_β are defined in section 2.

Positive dihedral, p leads β by 45 deg to 225 deg:

$$\sim \text{Negative } C'_{\ell\beta} + \frac{\rho gb}{4(W/S)} C_{y\beta} C'_{\ell r}$$

Negative dihedral, p leads β by 225 deg through 360 deg to 45 deg:

$$\sim \text{Positive } C'_{\ell\beta} + \frac{\rho gb}{4(W/S)} C_{y\beta} C'_{\ell r}$$

$$\text{Adverse yaw, } -180 \text{ deg} \geq \psi_\beta \geq -270 \text{ deg} \sim \omega_\phi/\omega_d < 1$$

$$\text{Proverse yaw, } 0 \geq \psi_\beta \geq -90 \text{ deg} \sim \omega_\phi/\omega_d > 1$$

$$\left(\frac{\omega_\phi}{\omega_d} \right)^2 \approx 1 - \frac{C'_{n\delta a} C'_{\ell\beta}}{C'_{\ell\delta a} C'_{n\beta}}, \quad \omega_d^2 \approx \frac{g}{C_{L1} k_z^2 b} C'_{n\beta}$$

MIL-STD-1797A
APPENDIX A

$$2\zeta_d \omega_d \approx -\frac{\rho g V}{2(W/S)} \left[C_{y\beta} + \frac{C'_{nr}}{2k_z^2} - \frac{k_z^2}{k_x^2} \frac{C'_{l\beta}}{C'_{n\beta}} \left(C_{L1} - \frac{C'_{np}}{2k_z^2} \right) \right]$$

$$2\zeta_\phi \omega_\phi \approx -\frac{\rho g V}{2(W/S)} \left[C_{y\beta} + \frac{1}{2k_z^2} \left(C'_{nr} - \frac{C'_{n\delta a}}{C'_{l\delta a}} C'_{lr} \right) - \frac{C_{y\delta a}}{C'_{l\delta a}} C'_{l\beta} \right]$$

where

$$C'_{li} = \frac{C_{li} + C_{ni} I_{xz}/I_z}{1 - I_{xz}^2/(I_x I_z)}, \quad C'_{ni} = \frac{C_{ni} + C_{li} I_{xz}/I_x}{1 - I_{xz}^2/(I_x I_z)}$$

$$C_{L1} = W/(\bar{q} S), \quad k_x^2 = I_x / (\text{mb}^2), \quad k_z^2 = I_z / (\text{mb}^2),$$

and control derivatives include the effects of any crossfeeds.

VERIFICATION LESSONS LEARNED

MIL-STD-1797A
APPENDIX A

4.5.1.5 Roll time delay.

The value of the equivalent time delay, τ_{ep} , shall be no greater than _____.

REQUIREMENT RATIONALE (4.5.1.5)

This requirement is intended to insure that the combined delay contributions of prefilters, stability augmentation, servos, etc., does not degrade the pilot's tracking capability in roll control.

REQUIREMENT GUIDANCE

The related MIL-F-8785C requirement is paragraph 3.5.3.

Recommended values of τ_{ep} , which is defined in 4.5.1.1, are given in table XXVII.

TABLE XXVII. Recommended allowable equivalent delay.

LEVEL	ALLOWABLE DELAY (sec)
1	0.10
2	0.20
3	0.25

Based upon extensive research into the effect of time delays in the pitch axis, the important contribution of delays is well known. This requirement extends to the roll axis the τ_e limits imposed on the pitch axis in 4.2.1.2. For lack of enough substantive data, the limits remain unchanged from MIL-F-8785C. Precise roll tracking, like pitch tracking, is a high-bandwidth task. As more data become available, these limits should be evaluated and adjusted if necessary.

4.5.1.1, which sets roll mode limits, discusses the use of equivalent system matching of the roll rate response to roll controller to extract T_S , T_R , and τ_{ep} . That section should be consulted for more information on the meaning of τ_{ep} .

SUPPORTING DATA

Little in the way of hard data is available. However, the effect of equivalent time delay was found to be significant in the longitudinal axis (see 4.2.1.1). This result is seen to extend to the lateral axis based upon the LATHOS study of AFWAL-TR-81-3171 (figure 168). In fact, for the demanding task used in the LATHOS program (air-to-air refueling and bank angle tracking on the HUD), any time delay above the basic NT-33 value resulted in Level 2 ratings. AFWAL-TR-81-3118 reports similarly that for simulated large transports in approach and landing any increase above the basic (0.12 sec) effective time delay could not support Level 1 ratings (figure 169). Hence there is at least evidence to support a need for such a requirement, though effective time delay may be more critical in the lateral than in the longitudinal axis.

REQUIREMENT LESSONS LEARNED

MIL-STD-1797A
APPENDIX A

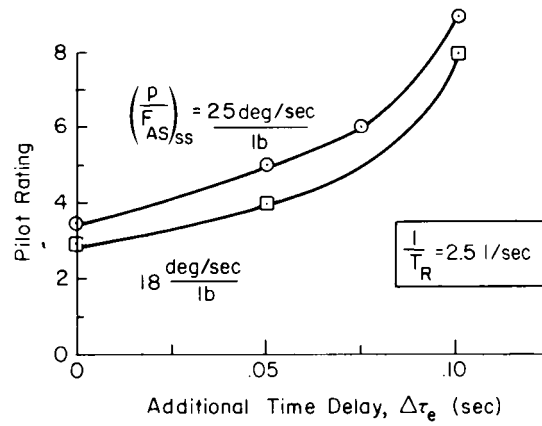

Note: $\Delta\tau_e$ represents the additional time delay above the basic NT-33 control system value of approximately .05 sec

FIGURE 168. Effect of time delay, LATHOS data (AFWAL-TR-81-3171).

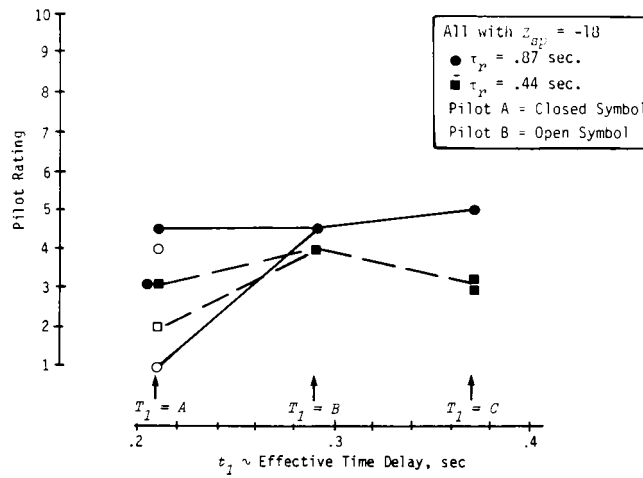

FIGURE 169. Pilot rating vs. time delay -- lateral-directional.

MIL-STD-1797A
APPENDIX A

5.5.1.5 Time delay-verification.

Verification shall be by analysis, simulation and flight test.

VERIFICATION RATIONALE (5.5.1.5)

In the end, flight test data or a flight-verified analytical model should be used to verify compliance.

A control surface rate limit may increase the equivalent time delay or roll-mode time constant as a function of the size of command.

VERIFICATION GUIDANCE

Appropriate values of τ_{ep} will require equivalent system matching, as discussed above. See guidance for 4.5.1.1.

VERIFICATION LESSONS LEARNED

MIL-STD-1797A
APPENDIX A

4.5.2 Pilot-induced roll oscillations.

There shall be no tendency for sustained or uncontrollable roll oscillations resulting from efforts of the pilot to control the aircraft. Specifically, _____.

REQUIREMENT RATIONALE (4.5.2)

This roll-axis requirement is stated in addition to the general requirement of 4.1.11.6 to emphasize its importance for the roll axis and to allow incorporation of a more quantitative requirement.

REQUIREMENT GUIDANCE

The related MIL-F-8785C requirement is paragraph 3.3.3.

Due to the present lack of a reliable quantitative measure, only the subjective statement is recommended at present. We make provision for insertion of a quantitative requirement at a later time. It is of course hoped that meeting the other quantitative requirements of this standard will prevent a lateral pilot-induced oscillation (PIO).

REQUIREMENT LESSONS LEARNED

See 4.2.2 for discussion of applicable considerations and data, in that case directed at longitudinal PIOs in general. Lateral PIOs have been less frequent, but there are one or two known cases and causes. For example, the M2-F2 lifting body (NASA-TN-D-6496) encountered several divergent PIOs during flight testing. The primary cause was found to be the coupled roll subsidence/spiral mode (see Lessons Learned for 4.5.1.3).

A second cause of observed lateral PIO tendencies is the ω_p/ω_d effect noted and explained in figure 158 and also in Norair Rpt No. NOR-64-143. Another less prevalent cause is associated with control-surface rate saturation. In this case the pilot tries to apply lateral control at a rate greater than the maximum surface rate, thereby getting out of phase if tight tracking is attempted. The quantitative aspects of such rate-limiting are given in the appendix of Norair Rpt No. NOR-64-143 and involve gain and phase decrements that are functions of the ratio of commanded to saturation rate.

PIOs on recent aircraft have been related to roll responses which are both too low (F-18) and too high (YF-16). These cases are discussed under 4.5.8.1 and 4.5.9.3.

5.5.2 Pilot-induced roll oscillations-verification.

Verification shall be by analysis, simulation and flight test.

VERIFICATION RATIONALE (5.5.2)

This requirement should apply to all flight conditions and tasks, and to all Levels, since zero or negative closed-loop damping is to be avoided under all flight conditions and failure states.

VERIFICATION GUIDANCE

The existence of a PIO tendency is difficult to assess. Therefore, no specific flight conditions or tasks are recommended, though a high-stress task such as approach and landing with a lateral offset, or terrain following, may reveal PIO proneness. Demanding tracking tasks, aggressive control, sensitive response, proverse yaw, low dutch roll damping and long equivalent time delay are factors varying with flight condition which may tend to incite roll PIOs. Lateral acceleration induced on the pilot in rolling may contribute

VERIFICATION LESSONS LEARNED

In a number of cases optimization of p/F_{as} in a fixed-base simulator has resulted in gross oversensitivity, in actual flight.

MIL-STD-1797A
APPENDIX A

4.5.3 Linearity of roll response o roll controller.

There shall be no objectionable nonlinearities in the variation of rolling response with roll control deflection or force. Sensitivity or sluggishness in response to small control deflections or force shall be avoided.

REQUIREMENT RATIONALE (4.5.3)

Nonlinear responses to control inputs can result in poor handling qualities. This requirement is intended to disallow forms and magnitudes of nonlinear response that interfere with precision control of bank angle.

REQUIREMENT GUIDANCE

The related MIL-F-8785C requirement is paragraph 3.3.4.4.

The requirement is directed at precision of control. Objectionable nonlinearities can be those due to excessive friction, detents, nonlinear force gradients (especially abrupt gradient changes short of maximum deflection) nonlinear $C_l(\delta_{as})$ or $C_n(\delta_{as})$, spoiler lag, etc.

REQUIREMENT LESSONS LEARNED

It is objectionable nonlinearities, not nonlinearities per se, at which this requirement is directed. Experience with roll command augmentation systems, in which roll rate response is made directly proportional to stick force, shows that some degree of nonlinearity is quite often desirable, if not necessary. This is discussed in 4.5.9.3. Figure 194 should be consulted for additional guidance.

5.5.3 Linearity of roll response to roll controller-verification.

Verification shall be by analysis, simulation and flight test.

VERIFICATION RATIONALE (5.5.3)

Tests using 1/4, 1/2, 3/4, and full aileron are commonly used to demonstrate compliance . Such tests can also be used to help determine k for use in 5.6.2. Spoilers located in a region of separated flow will have a dead-zone type nonlinearity.

Any problems with control nonlinearities should be evident in a series of large- and small-amplitude rapid target acquisition and precise tracking maneuvers. (The target may be another maneuvering aircraft, a runway threshold, the horizon, lateral acceleration, etc. as appropriate.)

VERIFICATION GUIDANCE

It has not been possible to specify values for tolerable levels of nonlinearities, so reliance must be placed on qualitative pilot evaluations.

VERIFICATION LESSONS LEARNED

MIL-STD-1797A
APPENDIX A

4.5.4 Lateral acceleration at pilot station.

With yaw control free and with it used to coordinate turn entry, the ratio of maximum lateral acceleration at the pilot station to maximum roll rate shall not exceed _____ for the first 2-1/2 seconds following a step roll control input.

REQUIREMENT RATIONALE (4.5.4)

Where the pilot is well forward of the center of gravity or well above the roll axis, turn entries with zero sideslip are accompanied by large lateral accelerations at the cockpit and entries with a centered ball may be impossible. This requirement is included to limit such accelerations to acceptable levels.

REQUIREMENT GUIDANCE

There is no related MIL-F-8785C requirement.

Recommended values:

Level	$n_{ypilot_{max}} / p_{max}$
1	0.012 g/deg/sec
2	0.035
3	0.058

Concern over lateral acceleration is primarily for ride qualities, although in some cases aircraft control can be affected due to arm/bobweight effects, or just the jerkiness associated with a large offset from the roll axis.

A criterion based on the ratio of maximum pilot acceleration to maximum roll rate includes in it the Am recognition that pilot acceptance of high accelerations is a function of aircraft rolling performance. Such a criterion was proposed by Chalk in NASA-CR-159236 for large aircraft, and the recommended values are based on flight results with the Total In-Flight Simulator (TIFS) (see Supporting Data). Some refinement of the limits may be necessary for Class I, II, and IV aircraft, and some modification may be in order if the crew are given more effective lateral restraints.

SUPPORTING DATA

Objectionable lateral acceleration was noted in the C-5A (AFFDL-TR-75-3), and fighter pilots (e.g. F-15) have remarked about their helmets hitting the canopy during abrupt rolls. The criterion was derived in NASA-CR-159236 as a proposed flying qualities requirement for Supersonic Cruise Research (SCR) aircraft. Figure 170 shows TIFS data compared with Cooper-Harper pilot ratings. Figure 171 gives more data for large aircraft, from AFWAL-TR-81-3118. Correlation is quite good, though more data should be gathered, especially for other Classes of aircraft.

Due to the tentative nature of this requirement, it should be applied primarily as a guideline until more data can be obtained.

REQUIREMENT LESSONS LEARNED

When dealing with aircraft in which the cockpit is either well forward of the center of gravity or well above the roll axis, designing the rudder augmentor to minimize sideslip or cg lateral acceleration can produce unacceptable lateral accelerations at the pilot station.

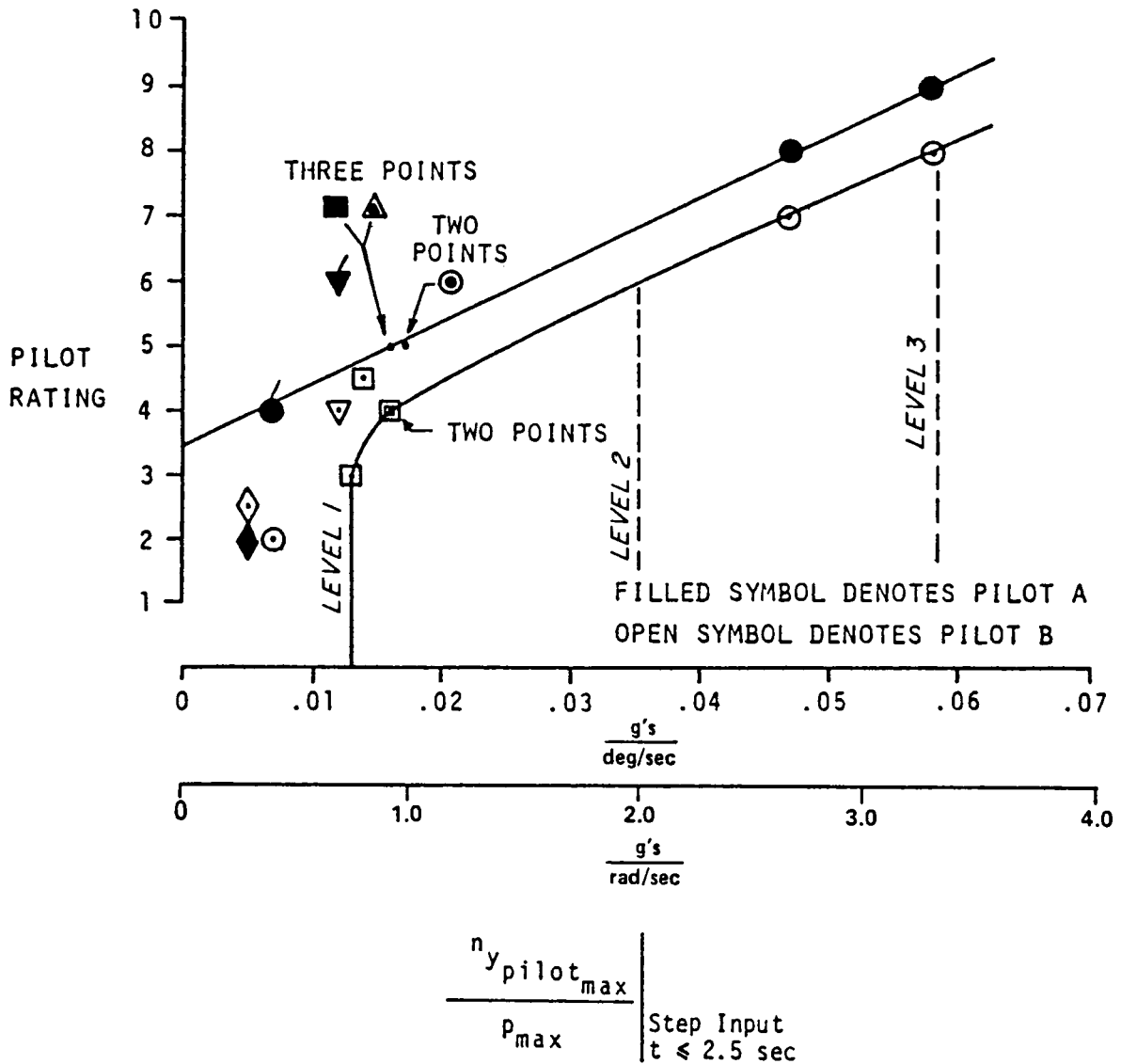

NOTES

1 - Flagged points are configurations specifically downgraded by Pilot A due to poor Dutch roll damping - not lateral acceleration.

2 The lines indicate degradation in pilot rating to be expected because of ride qualities for an airplane with otherwise satisfactory flying qualities parameters.

FIGURE 170. Lateral acceleration criterion versus pilot rating from NASA-CR-159236.

MIL-STD-1797A
APPENDIX A

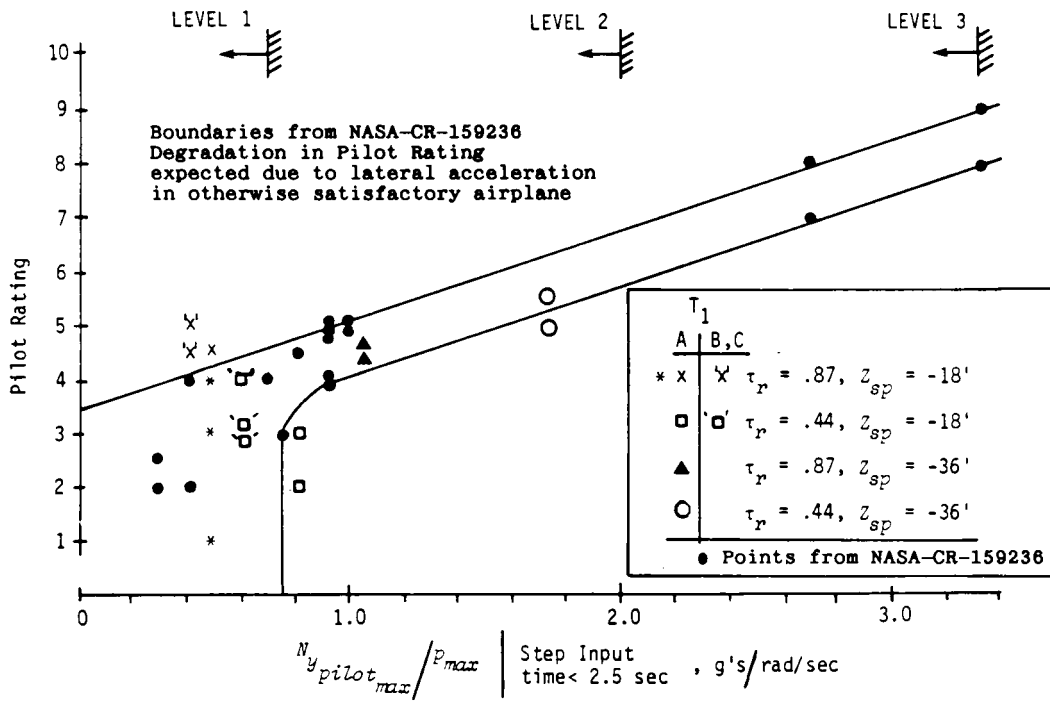

FIGURE 171. Pilot rating vs lateral acceleration criteria.

Note: The three * points are from the baseline configuration Long Aft, High q. T₁ = A; Pilot A - one point, Pilot B - two points. These were evaluated during the longitudinal variations and no lateral-directional comments were made.

With direct side force control another possibility for lessening the magnitude of lateral acceleration in rolling is to control the height of the roll axis: modify the effective Y_{δ_a}.

5.5.4 Lateral acceleration at the pilot station-verification.

Verification shall be by analysis, simulation and flight test.

VERIFICATION RATIONALE(S.S.4)

Both large and small step roll control inputs should be used and measurements made within the first 2.5 sec of application of the control.

VERIFICATION GUIDANCE

Lateral acceleration at a distance (x, z) from the cg is given by

$$a_y = \dot{v} + ru - pw - g \cos\theta \sin\phi - z\dot{p} + x\dot{r}$$

For a step aileron input the initial lateral acceleration is

$$\frac{n_{y_{p0}}}{\dot{p}_0} = -\frac{z_p}{g} + \frac{x_p}{g} \frac{N'_{\delta_a}}{L'_{\delta_a}} + \frac{1}{g} \frac{Y_{\delta_a}}{L'_{\delta_a}} = -\frac{z_p}{g} \left(1 + \frac{x_p k_x^2 C'_{n_{\delta_a}}}{z_p k_z^2 C'_{l_{\delta_a}}} - \frac{b}{z_p} k_x^2 \frac{C_{y_{\delta_a}}}{C'_{l_{\delta_a}}} \right)$$

MIL-STD-1797A
APPENDIX A

and in a steady turn, with θ and ϕ in stability axes ($w = 0$)

$$\dot{\psi} = \frac{g}{V \cos \beta} \tan \phi + \frac{n_y}{\cos \theta \cos \phi}$$

where $k_x^2 = I_x/(mb^2)$ and $k_z^2 = I_z/(mb^2)$ in terms of stability axes and primed derivatives which account for product of inertia effects; x and y are distances from the center of gravity.

Conceivably dutch roll phasing could make another time more critical, but 2 1/2 seconds is a reasonably long duration for a roll maneuver.

VERIFICATION LESSONS LEARNED

MIL-STD-1797A
APPENDIX A

4.5.5 Roll characteristics in steady sideslip.

In the straight, steady sideslips of 4.6.1.2:

a. An increase or no change in right bank angle shall accompany an increase in right sideslip; and an increase or no change in left bank angle shall accompany an increase in left sideslip.

b. Right or zero roll-control deflection and force shall accompany right sideslips, and left or zero roll-control deflection and force shall accompany left sideslips. For Levels 1 and 2, the variation of roll-control deflection and force with sideslip angle shall be essentially linear. This requirement may, if necessary, be excepted for waveoff (go-around) if task performance is impaired and no more than 50 percent of roll-control power available to the pilot, and no more than 10 pounds of roll-control force, are required in a direction opposite to that specified herein.

REQUIREMENT RATIONALE (4.5.5)

This requirement insures that the bank angle and roll control in straight, steady sideslips is conventional, in accordance with pilot training and experience.

REQUIREMENT GUIDANCE

The related MIL-F-8785C requirements are paragraphs 3.3.6, 3.3.6.2, 3.3.6.3, 3.3.6.3.1, and 3.3.6.3.2.

This requirement is intended to apply at positive normal load factor. The bank angle is the angle necessary to straighten the flight path while sideslipping. While there is some evidence that pilots do not object to zero bank in straight sideslips, weak or zero side-force characteristics lessen the usefulness of the ball-bank indicator for trimming and for coordinating turns, and seat-of-the-pants feel. Opposite bank seems disconcerting. Therefore, we require only that bank angle does not change adversely with sideslip. Normally this requirement on side-force is easily met.

The second requirement involves principally the roll static stability and control hinge moments or feel. The NW relaxation for waveoff (go-around) has been found both necessary on occasion and tolerable. In this exception, allowable roll-control force is not made a function of the type of controller, since one-handed operation must be assumed for the waveoff or go-around maneuver. The phrase "available to the pilot" is used because control surface position can be determined by both the pilot and the stability augmentation system.

This requirement normally (but not necessarily) will preclude negative effective dihedral. It is not desirable to use rudder-to-aileron crossfeeds to meet this requirement inasmuch as such mechanizations augment $L_{\delta_{rp}}$ and not L_{β} as desired. Other requirements - 4.5.8.2, 4.5.8.6 and 4.5.9.5.4 - limit the amount of positive effective dihedral.

In reviewing this requirement (for MIL-F-8785B), consideration was given to putting some lower limit on dihedral effect since data such as those presented in Princeton Univ Rpt 727 (see figure 135) indicate that zero or low L_{β} is undesirable. Princeton Univ Rpt 727 indicates that the zero- L_{β} configurations were downrated because the pilots were forced to use rudder pedals to damp the dutch roll oscillations. Fighter pilots, in particular, desired some dihedral to enable them to damp the dutch roll using ailerons alone. On the other hand, pilots evaluating a prototype assault transport (YC- 15) with zero effective dihedral liked it, commenting on the uncoupled yaw response to rudder.

REQUIREMENT LESSONS LEARNED

5.5.5 Roll characteristics in steady sideslip-verification.

Verification shall be by analysis, simulation and flight test.

VERIFICATION RATIONALE (5.5.5)

A series of steady sideslips, as specified for the yaw axis, should be performed at flight conditions over the operating envelope of the aircraft, measuring sideslip and bank angles, yaw and roll rates (to assure that they are zero) and yaw and roll controller and control surface deflections and control forces.

VERIFICATION GUIDANCE

While linearity with p is not always required, excursions to large sideslip should serve to bring out any disconcerting behavior that might not be encountered otherwise in flight testing.

$$\frac{d\phi}{d\beta} = \frac{-\rho V^2 C_{y\beta}}{2(W/S)} \left[1 - \frac{C_{y\delta_r} C_{n\beta}}{C_{n\delta_r} C_{y\beta}} \left(\frac{1 - \frac{C_{n\delta_a} C_{\ell\beta}}{C_{\ell\delta_a} C_{n\beta}}}{1 - \frac{C_{n\delta_a} C_{\ell\delta_r}}{C_{\ell\delta_a} C_{n\delta_r}}} \right) - \frac{C_{y\delta_a} \left(C_{\ell\beta} - \frac{C_{\ell\delta_r}}{C_{n\delta_r}} C_{n\beta} \right)}{C_{\ell\delta_a} C_{y\beta} \left(1 - \frac{C_{n\delta_a} C_{\ell\delta_r}}{C_{\ell\delta_a} C_{n\delta_r}} \right)} \right]$$

$$\approx \frac{-C_{y\beta}}{C_{L1}} \left(1 - \frac{C_{y\delta_r} C_{n\beta}}{C_{n\delta_r} C_{y\beta}} \right)$$

$$\frac{d\delta_a}{d\beta} = - \left[\frac{C_{\ell\beta} - \frac{C_{\ell\delta_r}}{C_{n\delta_r}} C_{n\beta}}{C_{\ell\delta_a} \left(1 - \frac{C_{n\delta_a} C_{\ell\delta_r}}{C_{\ell\delta_a} C_{n\delta_r}} \right)} \right]$$

using effective values of the control derivatives which account for crossfeeds. Lateral-acceleration feedback to rudder will have secondary effects on $d\delta_a/d\beta$.

VERIFICATION LESSONS LEARNED

MIL-STD-1797A
APPENDIX A

4.5.6 Roll axis control for takeoff and landing in crosswinds.

It shall be possible to take off and land with normal pilot skill and technique in the 90 deg crosswinds of 4.6.4.

REQUIREMENT RATIONALE (4.5.6)

This requirement assures good roll-axis flying qualities in crosswind takeoffs and landings.

REQUIREMENT GUIDANCE

The related MIL-F-8785C requirement is paragraph 3.3.7.

Recommended crosswind values are listed in 4.6.4.

The crosswind of 4.6.4 should also be used for the roll power (4.5.8.3) and force (4.5.9.5.3) and engine-failure (4.5.8.3, etc.) requirements.

REQUIREMENT LESSONS LEARNED

Roll control difficulty in crosswind operation may result from high lateral stability and is influenced by the crosswind technique adopted. Gusts can be expected to accompany strong crosswinds.

5.5.6 Roll axis control for takeoff and landing in crosswinds-verification.

Verification shall be by analysis, simulation and flight test.

VERIFICATION RATIONALE (5.5.6)

The design crosswinds are just about impossible to find when needed for flight test, so flight testing must take advantage of what winds occur, with due regard for safe buildups and avoiding extreme gustiness. Since flight testing close to the ground in steady, 90 degree crosswinds of the specified velocity may be unacceptably hazardous for Level 2 and 3 operations, those takeoffs and landings may be performed in some crosswinds less than (but close to) the required velocity. Additional slow flight may then be conducted at a safe (but low) altitude.

VERIFICATION GUIDANCE

Some crosswind relationships are discussed under 4.5.8.3. For application as a control authority design requirement, no account should be taken of variation of wind speed with height above the surface.

VERIFICATION LESSONS LEARNED

4.5.7 Roll axis response to other inputs

4.5.7.1 Roll axis response to augmentation failures.

With controls free, for at least _____ seconds following the failure, the aircraft motions due to partial or complete failure of the augmentation system shall not exceed the following limits: _____.

REQUIREMENT RATIONALE (4.5.7.1)

Adequate protection for failure transients must be provided in each axis, in case corrective action is delayed even slightly.

REQUIREMENT GUIDANCE

The related MIL-F-8785C requirements are paragraphs 3.4.8, 3.4.9, and 3.5.5.1.

Recommended values:

For at least 2 seconds following failure:

Levels 1 and 2 (after failure)	The limits are +0.5 g incremental lateral acceleration at the pilot's station and 10 deg per second roll rate, except that neither stall angle of attack nor structural limits shall be exceeded. In addition, for Category A, ± 2 deg bank angle
Level 3 (after failure)	No dangerous attitude or structural limit is reached, and no dangerous alteration of the flight path results from which recovery is impossible.

Similar requirements are found in the pitch and yaw axes (4.2.6.1 and 4.6.5.2, respectively). The two-second interval is to account for crew distraction and the possible need for time to determine and accomplish corrective action.

The general flying qualities requirement of 4.1.11.4 governs allowable aircraft motion when corrective action is taken. Another set of limits is specified here to assure that the stability and control augmentation itself does not contribute undue hazard in case it fails.

REQUIREMENT LESSONS LEARNED

5.5.7 Roll axis response to other inputs-verification

5.5.7.1 Roll axis response to augmentation failures-verification.

Verification shall be by analysis, simulation and flight test.

VERIFICATION RATIONALE (5.5.7.1)

The test aircraft may need special provisions for introducing specific failures in flight. Analysis or simulation should precede such flight tests in order to avoid excessively risky combinations of failure and flight condition.

VERIFICATION GUIDANCE

Any failures specified under 4.1.7.4 should be evaluated in flight testing at the appropriate flight conditions. Other failures and worst-case flight conditions will be found from the failure mode and effect analyses of 4.1.7.3.

MIL-STD-1797A
APPENDIX A

VERIFICATION LESSONS LEARNED

MIL-STD-1797A
APPENDIX A

4.5.7.2 Roll axis response to configuration or control mode change.

The transient motions and trim changes resulting from configuration changes or the engagement or disengagement of any portion of the primary flight control system due to pilot action shall be such that dangerous flying qualities never result. With controls free, the motion transients resulting from these situations shall not exceed the following limits for at least seconds following the transfer: These requirements apply only for Aircraft Normal States.

REQUIREMENT RATIONALE (4.5.7.2)

Roll transients due to intentional mode switching must not be excessive.

REQUIREMENT GUIDANCE

The related MIL-F-8785C requirements are paragraphs 3.5.6 and 3.5.6.1.

Recommended values for transient motions (within first 2 sec following transfer):

Within the Operational Flight Envelope: $\dot{\alpha}$ 3 deg/sec roll

Within the Service Flight Envelope: $\dot{\alpha}$ 5 deg/sec roll

This requirement is intended to apply both to pilot-initiated changes and to automatic changes initiated by selection of weapons, flap setting, etc.

Since the intent of a flight control system is to improve the aircraft response characteristics--whether measured by improved flying qualities or by increased mission effectiveness--any system which can be chosen by the pilot should not cause objectionable transient motions. There has been some speculation as to whether some small transient motion is or is not desirable. The argument for an intentional transient is that inadvertent pilot switching of autopilot modes is less likely if accompanied by a noticeable transient motion.

REQUIREMENT LESSONS LEARNED

5.5.7.2 Roll axis response to configuration or control mode change-verification.

Verification shall be by analysis, simulation and flight test.

VERIFICATION RATIONALE (5.5.7.2)

Flight testing should be straightforward, using the production flight control system control panel.

VERIFICATION GUIDANCE

No specific guidance is offered except that tests should be conducted at the most critical flight conditions. Similar requirements for pitch (5.2.6.2) and yaw (5.6.5.3) should be considered concurrently.

Flight testing for any control systems must be performed at the corners of the expected operational envelopes (e.g., a SAS for power approach must be switched at the highest and lowest expected airspeeds, at low altitudes). Limited analytical and ground-based simulation may be used to supplement actual flight testing, especially in the early stages of development. But flight testing is ultimately required.

VERIFICATION LESSONS LEARNED

4.5.8 Roll axis control power

4.5.8.1 Roll axis response to roll control inputs.

The response to full roll control input shall have the following characteristics: _____. These requirements apply throughout the applicable speed -- altitude -- load factor envelopes, except that the structural limits on combined rolling and normal acceleration need not be exceeded. For rolls from steady banked flight, the initial condition shall be coordinated, that is, zero sideslip. The requirements apply to roll commands to the right and to the left, initiated both from steady bank angles and from wings-level, straight flight except as otherwise stated.

Inputs are to be abrupt, with time measured from the application of control force. The pitch control is to be held fixed throughout the maneuver. Yaw control pedals shall remain free for Class IV aircraft for Level 1, and for all carrier-based aircraft in Category C Flight Phases for Levels 1 and 2; but otherwise, yaw control pedals may be used to reduce sideslip that retards roll rate (not to produce sideslip that augments roll rate) if such control inputs are simple, easily coordinated with roll control inputs and consistent with piloting techniques for the aircraft Class and mission.

For Flight Phase TO, the time required to bank may be increased proportional to the ratio of the rolling moment of inertia at takeoff to the largest rolling moment of inertia at landing, for weights up to the maximum authorized landing weight.

REQUIREMENT RATIONALE(4.5.8.1)

Roll power is specified in terms of bank angle change in a given time, a form related to operational use of the aircraft, to allow necessary maneuvering and attitude regulation.

REQUIREMENT GUIDANCE

The related MIL-F-8785C requirements are paragraphs 3.3.4, 3.3.4.1, 3.3.4.1.1, 3.3.4.1.2 and 3.3.4.2.

The following paragraphs indicate the recommended requirements by aircraft Class.

1. Class I and II Aircraft

Roll performance in terms of a bank angle change in a given time, ϕ_t , is specified in table XXVIII

MIL-STD-1797A
APPENDIX A

TABLE XXVIII. Roll performance for Class I and II aircraft.

Time to achieve the stated bank angle change (seconds)

CLASS	LEVEL	CATEGORY A		CATEGORY B		CATEGORY C	
		60 deg	45 deg	60 deg	45 deg	30 deg	25 deg
I	1	1.3		1.7			1.3
I	2	1.7		2.5			1.8
I	3	2.6		3.4			2.6
II-L	1		1.4		1.9	1.8	
II-L	2		1.9		2.8	2.5	
II-L	3		2.8		3.8	3.6	
II-C	1		1.4		1.9		1.0
II-C	2		1.9		2.8		1.5
II-C	3		2.8		3.8		2.0

2. Class III Aircraft

Roll performance in terms of ϕ_t is specified in table XXIX over the following ranges of airspeeds:

SPEED RANGE SYMBOL	EQUIVALENT AIRSPEED RANGE
L	$V_{\min} \leq V < 1.8 V_{\min}$
m	$1.8 V_{\min} \leq V < 0.7 V_{\max}$
H	$0.7 V_{\max} \leq V V_{\max}$

except that Level 1 roll performance is required only in the Operational Flight Envelope -- that is, from $V_{0\min}$ to $V_{0\max}$.

TABLE XXIX. Roll performance for Class III aircraft.

Time to achieve 30 deg bank angle change (seconds)

LEVEL	SPEED RANGE	CATEGORY A	CATEGORY B	CATEGORY C
1	L	1.8	2.3	2.5
	M	1.5	2.0	2.5
	H	2.0	2.3	2.5
2	L	2.4	3.9	4.0
	M	2.0	3.3	4.0
	H	2.5	3.9	4.0
3	ALL	3.0	5.0	6.0

Ashkenas (in AFFDL-TR-66-148) recommends an additional requirement, based on landing approach of large aircraft: 10 to 15 degrees per second is the maximum roll rate observed in smoothly performed sidestep maneuvers (no abrupt inputs).

MIL-STD-1797A
APPENDIX A

3. Class IV Aircraft

Roll performance is specified over the following ranges of airspeeds:

SPEED RANGE SYMBOL	EQUIVALENT AIRSPEED RANGE
VL	$V_{\min} \leq V < V_{\min} + 20 \text{ kt}$
L	$V_{\min} + 20 \text{ KTS} \leq V < 1.4 V_{\min}$
M	$1.4 V_{\min} \leq V < 0.7 V_{\max}$
H	$0.7 V_{\max} \leq V \leq V_{\max}$

except that the Level 1 roll performance requirements apply only in the Operational Flight Envelope -- that is, from $V_{o_{\min}}$ to $V_{o_{\max}}$.

Note that for some particular cases some of these speed ranges may not exist. The requirements apply, of course, only within speed ranges that do exist.

General roll performance in terms of ϕ_t is specified in table XXX. Roll performance for Flight Phase CO is specified in table XXXI in terms of ϕ_t for 360-degree rolls initiated at 1 g, and in table XXXII for rolls initiated from coordinated turns, keeping approximately constant normal load factor, at load factors between $0.8 n_o(-)$ and $0.8 n_o(+)$. For Flight Phase CO these requirements take precedence over table XXX. The roll performance requirements in Flight Phase GA with large complements of external stores may be relaxed from those specified in table XXX, subject to approval by the procuring activity. For any external loading specified in the contract, however, the roll performance shall be not less than that in table XXXIII for rolls initiated at load factors between $0.8 n_o(-)$ and $0.8 n_o(+)$.

For all Class IV aircraft, clean and with symmetric and asymmetric air-to-air and air-to-ground loadings, when abrupt lateral control inputs are used to terminate the bank-to-bank roll maneuvers after achieving the bank angle changes specified in tables XXXII and XXXIII, aircraft motions after roll termination shall not involve loss of control, stall, or exceedance of structural limits.

MIL-STD-1797A
APPENDIX A

TABLE XXX. Roll performance for Class IV aircraft.

Time to achieve the stated bank angle change (seconds)

LEVEL	SPEED RANGE	CATEGORY A			CATEGORY B	CATEGORY C
		30 deg	50 deg	90 deg	90 deg	30 deg
1	VL	1.1			2.0	1.1
	L	1.1			1.7	1.1
	M			1.3	1.7	1.1
	H		1.1		1.7	1.1
2	VL	1.6			2.8	1.3
	L	1.5			2.5	1.3
	M			1.7	2.5	1.3
	H		1.3		2.5	1.3
3	VL	2.6			3.7	2.0
	L	2.0			3.4	2.0
	M			2.6	3.4	2.0
	H		2.6		3.4	2.0

TABLE XXXI. Flight phase CO roll performance in nominal 1-g rolls.

Time to achieve the stated bank angle change (seconds)

LEVEL	SPEED RANGE	30 deg	90 deg	180 deg	360 deg
1	VL	1.0			
	L		1.4	2.3	4.1
	M		1.0	1.6	2.8
	H		1.4	2.3	4.1
2	VL	1.6			
	L	1.3			
	M		1.3	2.0	3.4
	H		1.7	2.6	4.4
3	VL	2.5			
	L	2.0			
	M		1.7	3.0	
	H		2.1		

MIL-STD-1797A
APPENDIX A

TABLE XXXII. Flight phase CO roll performance, n>I.

Time to achieve the following bank angle change (seconds)

LEVEL	SPEED RANGE	30 deg	50 deg	90 deg	180 deg	
1	VL	1.0	1.1	1.1	2.2	
	L					
	M	1.0	1.1			
	H					
2	VL	1.6	1.4	1.4	2.8	
	L	1.3				
	M	1.4				1.4
	H					
3	VL	2.5	1.7	1.7	3.4	
	L	2.0				
	M	1.7				1.7
	H					

TABLE XXXIII. Flight phase GA roll performance.

Time to achieve the stated bank angle change (seconds)

LEVEL	SPEED RANGE	30 deg	50 deg	90 deg	180 deg	
1	VL	1.5	1.7	1.7	3.0	
	L					
	M	1.5	1.7			
	H					
2	VL	2.8	2.4	2.4	4.2	
	L	2.2				
	M	2.4				2.4
	H					
3	VL	4.4	3.4	3.4	6.0	
	L	3.8				
	M	3.4				3.4
	H					

The tables, definitions, and wording of this requirement are collations of the various roll control effectiveness sections of MIL-F-8785C.

MIL-STD-1797A
APPENDIX A

Discussion of Class IV requirements

For Class IV aircraft the Operational and Service Flight Envelopes have been divided into speed ranges with different requirements for the different speeds. This change reflects lessons learned that the roll requirements were too stringent to be met at the speed extremes of the envelopes. In general, the revision retains the MIL-F-8785B roll requirements in the speed range "M", with some relaxation in the other speed ranges.

The initial proposals for the speed ranges were defined using ASD experience with the F-15 and F-16. At the 1978 Flying Qualities Symposium the authors of MIL-F-8785C presented a modified definition of the speed range (AFFDL-TR-78-171). The suggested modification - to have the four speed ranges as a function of load factor -- was incorrect. The intent is to require a certain roll performance at all load factors in an operationally useful speed range, as sketched. The problem then becomes one of defining the required speeds in a general way.

The definitions proposed in "Proposals for Revising MIL-F-8785B, 'Flying Qualities of Piloted Airplanes'" have been retained. We believe that these represent the requirement for superior roll performance at combat flight conditions. The procuring activity should retain that philosophy in developing a system specification. It may be that these definitions still do not cover all cases. It is emphasized that the proposed speed ranges should be tailored to the specific application. The intent is to provide sufficient roll maneuverability to do the task at the normal speeds for that task, with a relaxation permitted for speeds at which the design penalty is too severe or less maneuverability is normally acceptable. In line with these speed ranges, the bank angle changes are compatible with the speed at which the roll performance will be demonstrated.

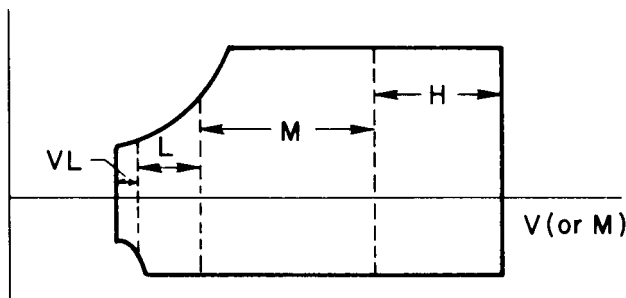

Relaxations in roll performance at low speed are concessions to the difficulty of doing better without adding excessive structural weight, actuator size, etc. We do this reluctantly, and some misgivings remain. In a recent air combat simulation (AFWAL-TR-80-3060) the single outstanding factor influencing convergence and kill was high roll performance at low airspeed. This was a fixed-base simulation, however, and the results must be balanced against feedback that pilots may not be able to use such roll rates at extreme flight conditions. Although past studies and analyses have indicated no need for roll performance that great, pilots have remained adamant on the requirement for 90 degrees bank in the first second (e.g. AFFDL-TR-69-72).

Abrupt termination of rolling maneuvers can cause large overshoots in sideslip, angle-of-attack and load factor. These characteristics should not detract from the mission capability of the aircraft. It must be noted that external tanks (both full and empty centerline, and empty wing tanks) should be considered in choosing the air-to-air configurations.

Note also the requirement of 4.5.8.6 for control with asymmetric loadings.

MIL-STD-1797A
APPENDIX A

Discussion of Class III requirements

Class III roll requirements have also been redefined in terms of three speed ranges. The basic requirements for Levels 2 and 3 were relaxed somewhat in MIL-F-8785C from MIL-F-8785B:

Category B, Level 2: 30 deg in 3.3 sec, instead of 3.0

Category B, Level 3: 30 deg in 5.0 sec, instead of 4.0

Category C, Level 2: 30 deg in 4.0 sec, instead of 3.2

Category C, Level 3: 30 deg in 6.0 sec, instead of 4.0

AFFDL-TR-72-41 concluded from a "review of roll control used in various experiments...[that] the roll control authority requirements...for Category C Flight Phases are excessive for airplanes that do not have high sensitivity to crosswind and turbulence. Data clearly indicate that there is an interaction between the roll control authority and the amount of roll damping and roll sensitivity to side velocity." The data (primarily for Class II and III airplanes) were: Level 1 boundary 16 deg in 1.8 sec⁹; 20 deg in 1.8 sec was adequate for Class II; 16 deg in 1.8 sec was not exceeded for Class III. Level 2 boundary 10 deg in 1.8 sec⁹, 6 deg in 2 sec. Figure 172 shows, on the same basis as in AFFDL-TR-69-72, that by the more demanding of these data the present Level 1 boundary is substantiated but the Level 2 boundary may be too lenient.

⁹ More control power than that was needed to counteract crosswinds and turbulence.

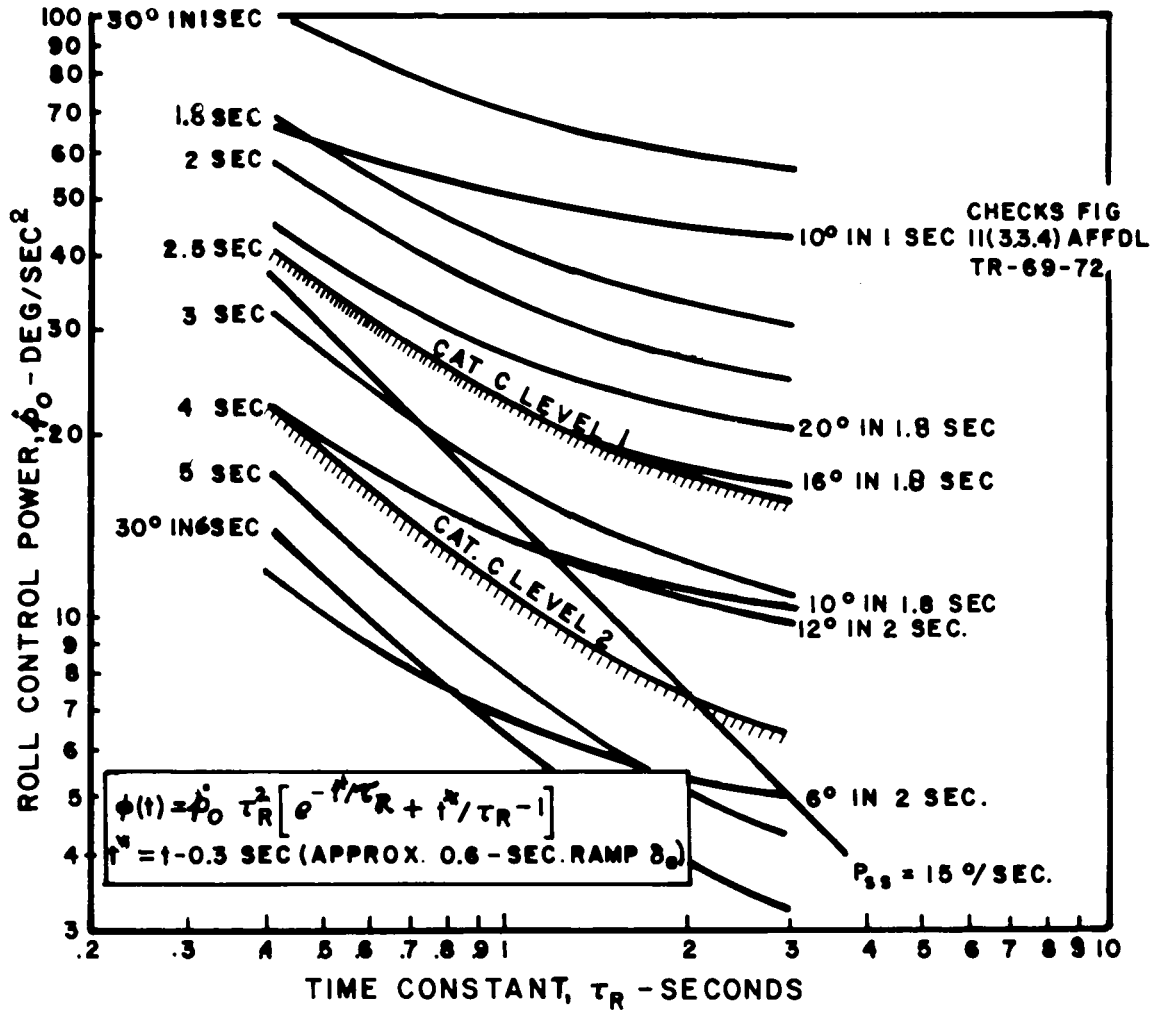
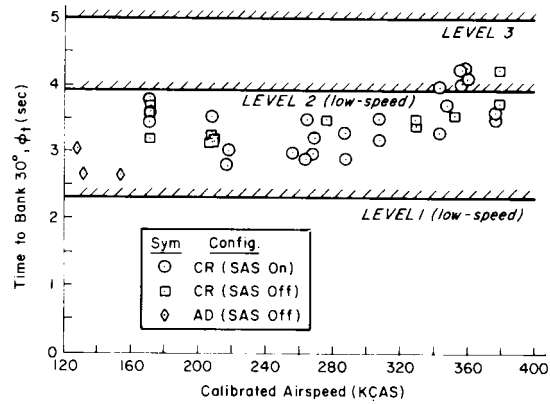

FIGURE 172. Roll control effectiveness parameters for Class III aircraft, Category C

Roll performance of the C-5A is shown on figure 173 (see Lessons Learned). The airplane does not meet the specification; however, "the roll acceleration available was considered satisfactory by the Joint Test Team on the basis of the offset landing maneuver, which was considered a practical test of lateral-directional maneuverability." In cruise the airplane was considered acceptable. ASD-TR-78-13 retained the MIL-F-8785B requirements for application to a production AMST, where the critical design case was to balance the rolling moment at stall with one engine failed. Thus, although there is some justification for relaxing the Class III roll requirements, that must be done considering the aircraft mission and potential operation. In AFFDL-TR-66-148 both Drake and Ashkenas find a need for a steady roll rate capability of 15 deg/sec or greater for the smooth offset-correction maneuvers typical of transport operation.

MIL-STD-1797A
APPENDIX A



a) Category B Flight Phases

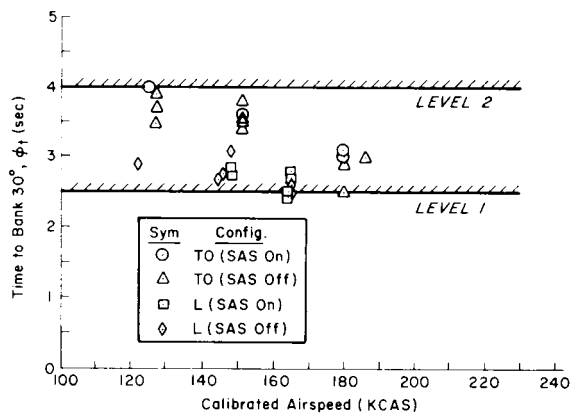

b) Category C Flight Phases

FIGURE 173. C-5A flight test data (from AFFDL-TR-75-3).

The roll axis

Of major importance in designing and producing an acceptable aircraft is the definition of the roll axis used in compliance. The roll axis is not specified exactly in these requirements. Its desired orientation varies with the pilot's intent: turns (or straightening out) to modify the flight path, barrel rolls to slow down. aileron rolls to start split Ss,....The most frequent, usually most important, use is the first-named, for turn entry or exit. With respect to the direction of flight, a roll axis tilted up corresponds to adverse yaw (nose lagging the turn entry) in stability axes; while a nose-down tilt indicates proverse yaw. At high angle of attack, rotation about any axis other than the flight path will generate sideslip, thus exciting dutch roll motion or even departure from controlled flight. Other studies have shown that a major contributor to departure is the $p\alpha$ term in the side-force equation:

$$\sum Y = mV (\dot{\beta} + r - p\alpha)$$

and $p\alpha_0$ is, of course, zero in stability axes.

However, compared to conventional body axes the cockpit is higher above a flight-path-aligned roll axis at high angles of attack. The result is spurious responses to roll control inputs: lateral acceleration as in the

MIL-STD-1797A
APPENDIX A

C-5A, F-15, etc.; visual slewing, e.g. of a runway threshold, found troublesome for the YF-16. These effects involve the kinematic relationships:

$$A_{y_p} = V_o \dot{\beta} + x_p \dot{r} + h_p \dot{p}$$

$$v_p = V_o \beta + x_p r + h_p p$$

Direct side force control can be combined with roll control to raise the roll axis if desired.

Also, at high angle of attack, rolling about other than the principal x axis creates a flywheel effect producing an incremental nose-up pitching moment, $p^2 I_{xz}$. See 5.1.11.5 VERIFICATION GUIDANCE and 4.8.1 REQUIREMENT GUIDANCE for further discussion.

In tracking a target, roll about the sight axis can avoid a troublesome pendulum effect: the initial motion of a depressed sight is opposite to the desired heading change.

All things considered, generally it appears best to generate and measure the roll motion in stability axes, examining the results carefully at high angle of attack, where the difference between body and stability axes is greatest. In order to achieve the needed roll performance it may be necessary to accept some uncomfortable lateral accelerations. However, if possible these accelerations should not exceed the limits established in 4.5.4.

Supporting data

Considerable flight test data and pilot commentary are available on a large number of modern aircraft. These will be shown to be extremely valuable in supporting the roll power requirements. However, for most of the data to be presented it is difficult to assure that all other lateral-directional characteristics (e.g., ζ_d , ω_d , T_R , T_S , $\Delta\beta/\kappa$) were Level 1, so qualitative evaluations may be somewhat biased by these other effects. Also, the operational speed ranges for Class III and IV aircraft are not always known, so it is necessary to compare the data only generally with the specific performance requirements. In some instances, data are given as specified in MIL-F-8785B -- times for a certain bank angle change; in others it may be given as required by the earlier MIL-F-8785 -- bank angle change in one second.

Class III aircraft data

AFFDL-TR-72-141 contains limited substantiation of the Class III, Category A and C requirements. For the P-3B airplane,

at speeds above about 240 KEAS, it was possible to achieve an attitude change of 30 degrees in about 1.5 seconds. Discussions with qualified P-3B pilots revealed that at speeds near and above 240 KEAS the aircraft had excellent roll maneuvering capability (aileron displacement is reduced, but forces are still a bother). These comments are considered adequate to act as substantiation of the Level 1 requirement for Category A Flight Phases...In Flight Phase PA at 125 KEAS full wheel deflection (112°) produces a 30 degree bank angle change in 2.6 seconds. This roll response was evaluated as acceptable but unpleasant. Part of the unpleasant aspect of this response is coupled with high lateral control forces and large lateral control displacements, assigned a Cooper Rating 3. The 30 degree bank angle change in 2.6 seconds is considered to be the minimum acceptable roll performance for Level 1 flying qualities and thus substantiates the Level 1 boundary of the specification (30 degree change in 2.5 seconds).

However, for a larger Class III airplane, the C-5A (AFFDL-TR-75-3), comparison with the performance requirements is poor, as figure 173 shows. Similar data for the C-141A, YC-141B, and L-1011 are given

MIL-STD-1797A
APPENDIX A

on figure 174, from AFFDL-TR-78-171. "Although neither the C-5A nor the C-141A/YC-141B comply with the rolling performance requirements, qualitative pilot comments indicate that both airplanes have acceptable rolling performance in the cruise configuration." In the landing configuration, for the C-5A (AFFDL-TR-75-3),

...the roll acceleration available was considered satisfactory by the Joint Test Team on the basis of the offset landing maneuver, which was considered a practical test of lateral directional maneuverability. The offset landing maneuver consists of approaching the runway with a 200 foot lateral misalignment on a 3 degree glideslope. At an altitude of 200 feet, the airplane is aligned with the runway centerline prior to touchdown.

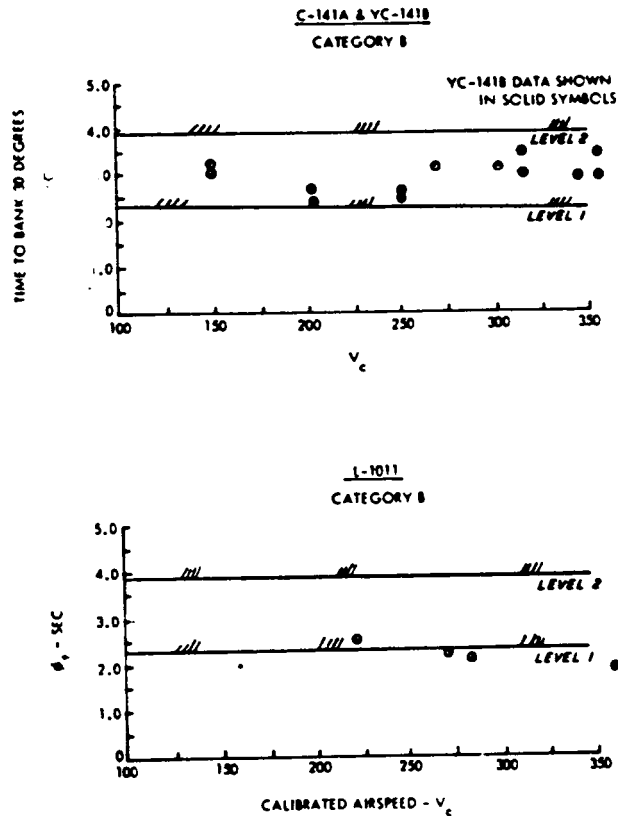

FIGURE 174. Roll performance for Class III aircraft (from AFFDL-TR-78-171).

But for the C-141, according to Woodcock and Mabli (AFFDL-TR-66-148).

Currently the aircraft is restricted to 20 knots [crosswind] and may remain so because of low lateral control power...the [airlift] command pilots interviewed generally consider it adequate for present operating conditions. AFFTC believes that as the minimum ceiling is reduced from 500 ft, C-141 operation will become limited by lateral control.

Acceptability of low roll performance may be a function of the amount of lateral acceleration felt by the pilot, i.e., as the acceleration due to rapid roll control inputs increases, pilot acceptance of the roll response decreases. For the C-5A, AFFDL-TR-75-3,

In order to meet the Level 1 requirements, the lateral control system would have to be improved to attain a higher bank angle change in the first second of roll. On an aircraft with

MIL-STD-1797A
APPENDIX A

a very large rolling moment of inertia, this would be difficult to accomplish. Increasing the initial roll response of the C-5A would further aggravate the very noticeable side kick, or lateral acceleration component, in the cockpit and troop compartment that is experienced during full abrupt control input. The side kick occurs since the cockpit and troop compartment are located considerably above the principal roll axis of the airplane

A requirement to operate into forward-area airstrips, or to land on short segments of bomb-damaged runways, demands more maneuvering than does airline-type operation. This should be borne in mind when evaluating comments based on operational experience.

The flight program of NASA-TN-D-5957 investigated roll requirements in cruise (Category B) for transport aircraft. A NASA Lockheed Jetstar was equipped with a model-following simulation to produce pure rolling response to ailerons, i.e.,

$$\frac{p}{\delta_a} = \frac{L_{\delta_a} T_R}{T_R s + 1}$$

The evaluation consisted of various rolling and turning maneuvers, including rapid rolls to 30 deg bank angle. Cooper-Harper ratings for three pilots are compared on figure 175 with times to bank 30 deg. Only those cases for which T_R is Level 1 are shown. These data support the Levels 1 and 2 roll requirements extremely well, and suggest that the Level 3 requirement could be relaxed from 5 sec to at least 8 sec or greater. They also show that a lower limit exists at somewhat less than one second due to high roll sensitivity.

MIL-STD-1797A
APPENDIX A

$$\frac{p}{\delta_a} = \frac{L\delta_a T_R}{T_R s + 1}$$

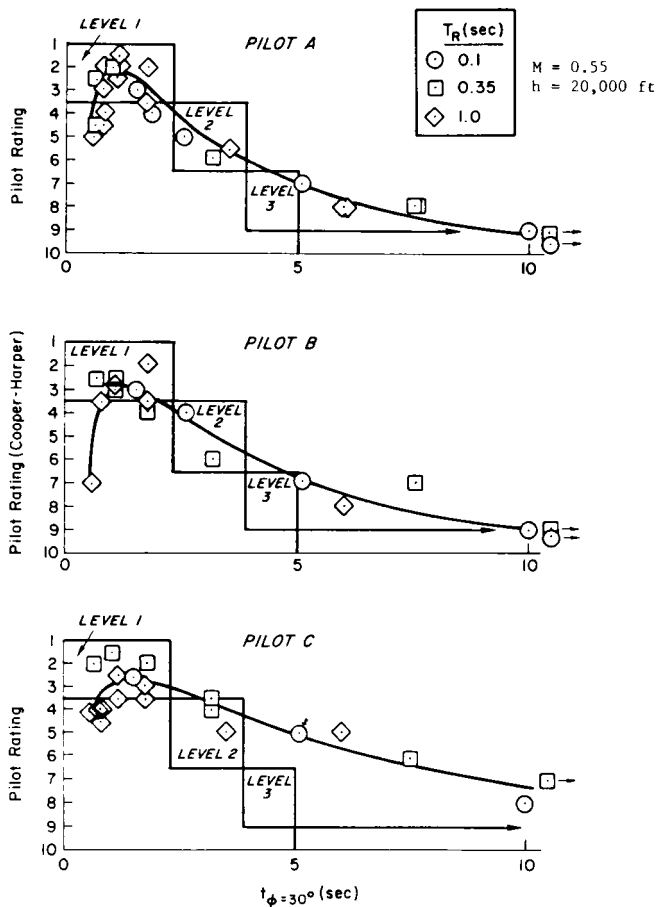

FIGURE 175. Comparison of pilot ratings for Class III aircraft in Category B Flight Phases with requirements of table XXIX (NASA-TN-D-5957).

It must be pointed out that since the Jetstar is considerably smaller, and of different design than the C-5A, the test pilots of NASA-TN-D-5957 would not have been subjected to the large lateral accelerations discussed above. It seems clear, however, that there is some need for addressing the incompatibility between the required Level 1 roll performance and the lateral acceleration on the occupants when objectionable accelerations result. Pilot ratings for a CV-990 (NASA-TN-D-681 1) in Category B and C flight support the Level 1 boundaries of table XXIX, as shown on figure 176.

MIL-STD-1797A
APPENDIX A

	Altitude, m (ft)	M or V_i , knots	Flaps, deg	Gear	
○	10,668 (35,000)	0.6 to 0.86	0	Up	} TABLE XXIX
□	6,096 (20,000)	0.4 to 0.85	0	Up	
◇	8,534 (28,000)	0.7	0	Up	
△	3,962 (13,000)	195	0	Up	
▲	3,962 (13,000)	195	0	Down	
▲	3,962 (13,000)	120 to 195	27	Down	
▲	3,962 (13,000)	120 to 175	50	Down	

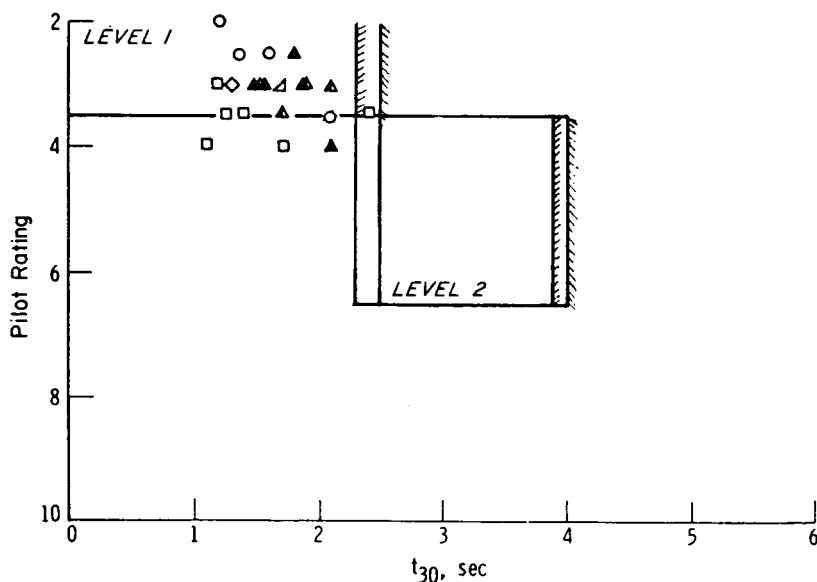

FIGURE 176. Time to bank, 300 for CV-990 (NASA-TN-D-681 1).

Class IV aircraft data

Data for the F-4 (AFFDL-TR-70-155) are given on figures 177, 178, and 179. Times to bank for these figures were not actual test values, but were calculated from known roll characteristics for various F-4 aircraft. Therefore, there is some inherent inaccuracy in the values of ϕ_t plotted. Figure 177 compares pilot ratings and ϕ_t with the Category B requirements of table XXX (for all speed ranges except VL). While the data are sparse, it at least appears that the Level 1 requirement of 90 deg in 1.7 sec is not too stringent. For Category C flight (figure 179), it is suggested that the limits may be too severe. AFFDL-TR-70-155 recommends that "For Class IV-L and -C aircraft, the Level 1 minimum time to bank to 30° should be relaxed to 1.3 seconds and the lower Level 3 boundary should be relaxed to 300° in 2.8 seconds." Of course, the impact of the figure 177 data is mitigated by recognizing the possible inaccuracies involved in computing ϕ_t without actual test data.

In figure 179 the boundaries drawn for times to bank 90 deg and 360 deg are for the most stringent requirements of table XXXI, i.e., for Speed Range M. The data tend to support the Level 1 limits, but suggest that the Level 2 limits could be relaxed considerably.

MIL-STD-1797A
APPENDIX A

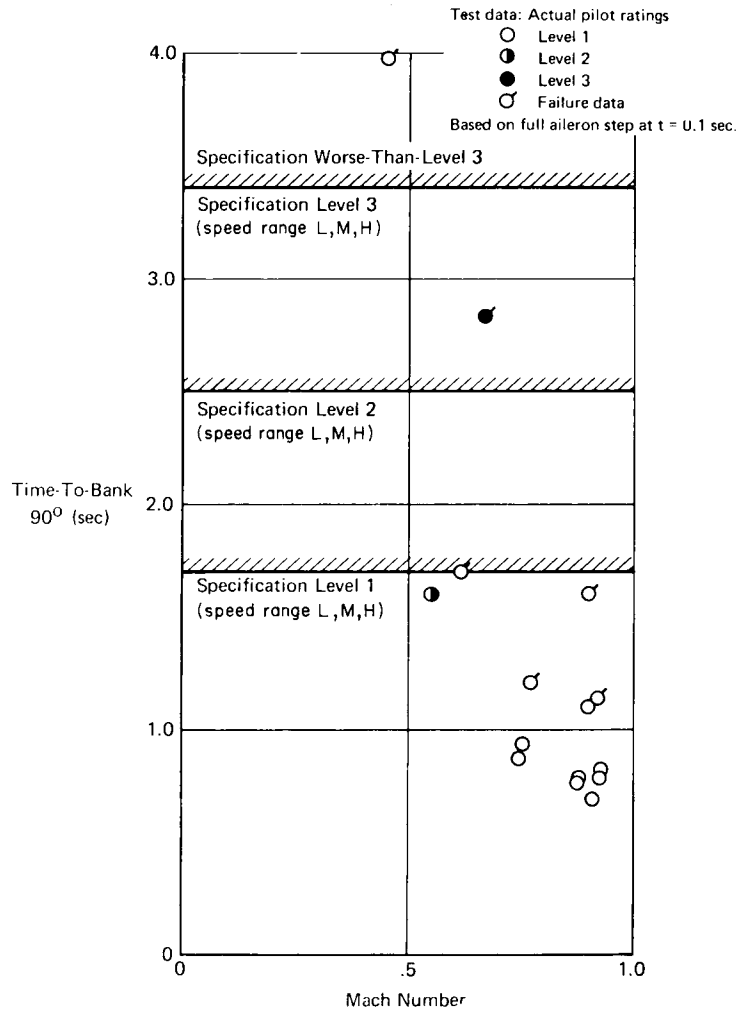

FIGURE 177. F-4 roll control effectiveness, time-to-bank 90° , CR configuration (from AFFFDL-TR-70-155).

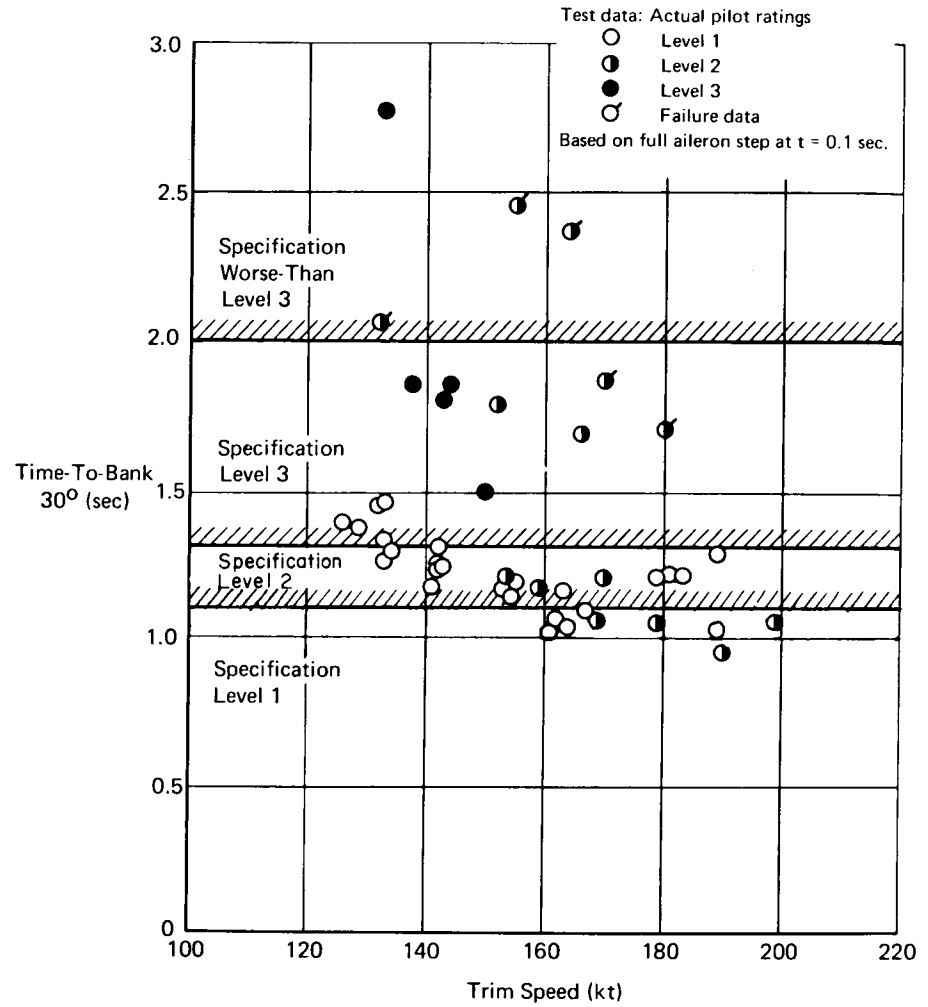
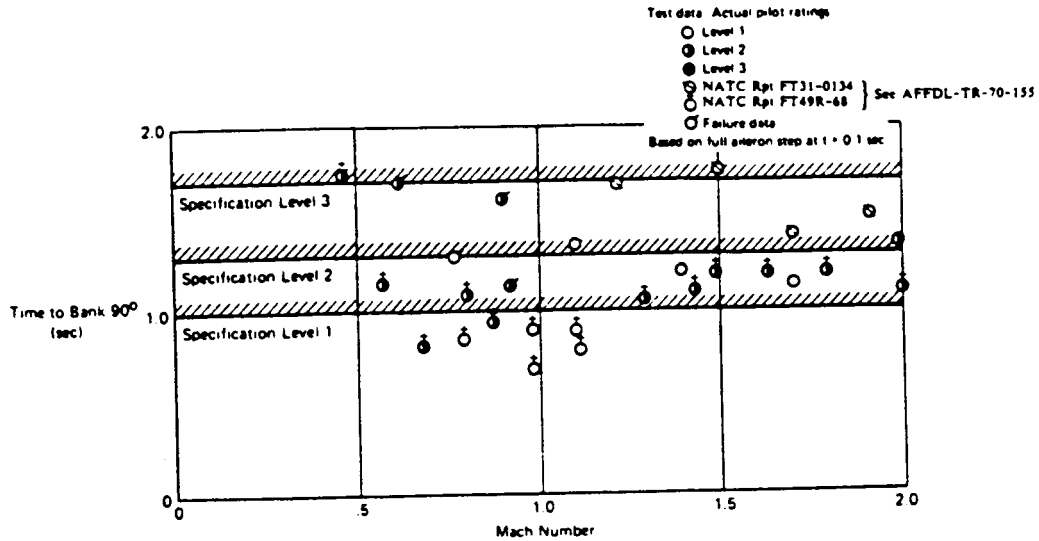
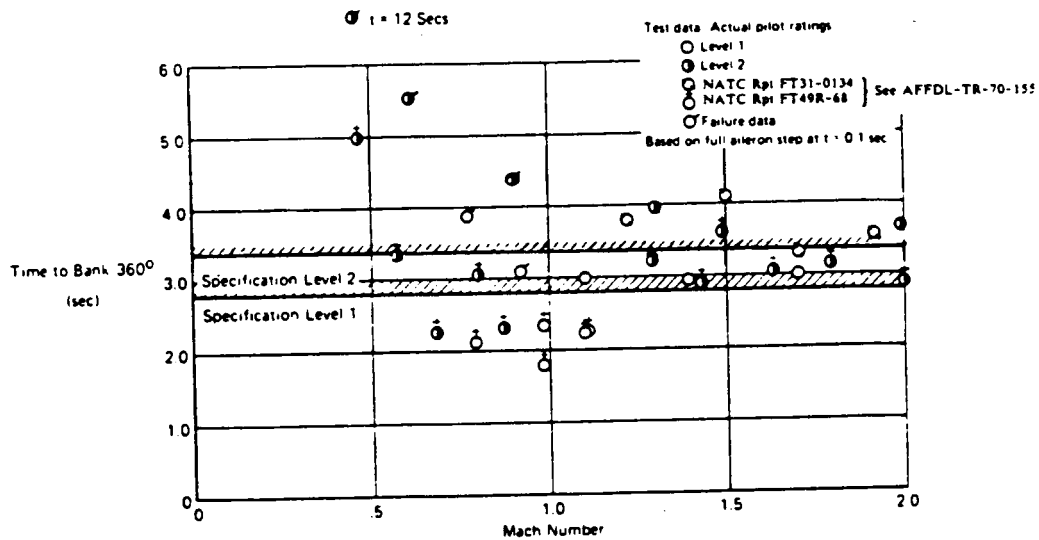

FIGURE 178. F-4 roll control effectiveness, time-to-bank 90° , CR configuration (from AFFFDL-TR-70-155).

MIL-STD-1797A
APPENDIX A



a) Time to Bank 90 deg



b) Time to Bank 360 deg

FIGURE 179. F-4 roll control effectiveness; CO configuration. Limits shown for speed range M, table XXXII (from AFFDL-TR-70-155).

F-5E data (figure 180, from AFFDL-TR-78-171) for Flight Phase CO at elevated load factors do not agree well with the Level 1 limits of table XXXII. The F-5E meets the requirement only in the High Speed Range.

AFFDL-TR-78-171 describes the roll performance as "very satisfactory in operational use," and according to AFFDL-TR-71-134, "the F-5 has exhibited favorable roll performance in air combat situations where both the rudder and ailerons were used at low speed and at high angles of attack."

MIL-STD-1797A
APPENDIX A

NOTE: FILLED SYMBOLS INDICATE MIL SPEC LIMITATION FOR LEVEL 1.
OPEN SYMBOLS ARE F-5E ROLL PERFORMANCE

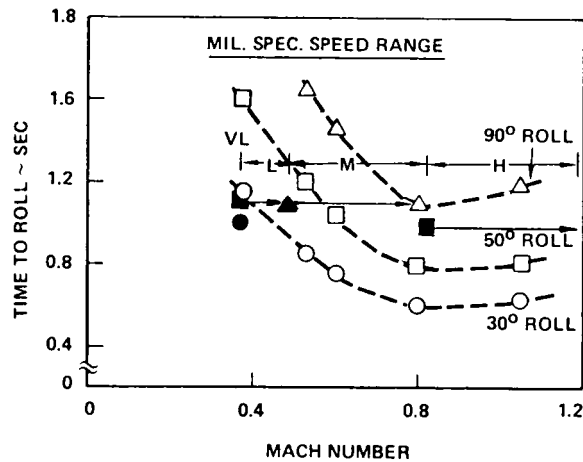

FIGURE 180. F-5E roll performance at 0.8 nL, configuration CO (from AFFDL-TR-78-171).

Flight test data for the F-14A in power approach are shown on figure 181, from navy Rpt No SA-C7R-75. Roll performance in terms of bank angle change in one second suggests that the F-14A would meet the table XXX. Category C requirement of 30 deg in 1.1 sec at low angles of attack, and fail to meet it at high angles of attack. Navy Rpt No. SA-C7R-75 states that "Lateral control effectiveness in the PA configurations was adequate to perform the bank angle changes required during approach."

The F-15C (AFFTC-TR-80-23) meets the Category A Level 1 requirement of 90 deg in 1.3 sec (Speed Range M), as figure 182 shows. Unfortunately, we do not have any pilot ratings or comments relating specifically to F-15 roll performance.

Navy Rpt No SA-14R-81 documents performance and handling qualities testing of a Navy F/A-18A airplane. This test airplane included various control system modifications over the prototype F/A-18A to correct deficiencies in the airplane's roll response. Results of 1-g, 360-deg rolls in cruise configuration are shown on figures 183 and 184. At moderate altitudes and at low speeds, the F/A-18A roll performance is quite good. However, for combinations of low altitude and high speed, the airplane is seen to be extremely sluggish. Steady-state roll rates as low as 50 deg/sec were encountered at 5000 ft altitude. From Navy Rpt No. SA-14R-81,

In that portion of the flight envelope where the time to 90° is less than or equal to 1 sec. the fleet pilot will be able to rapidly and efficiently maneuver the airplane to track an aggressive target as well as perform rapid evasive maneuvers required during air-to-air and air-to-ground tactical maneuvers.... The excessive time to roll to 90° at low to medium altitude, high q flight conditions will preclude the pilot's ability to effectively perform the air-to-air and air-to-ground missions.

MIL-STD-1797A APPENDIX A

SYMBOL	LOADING	GROSS WEIGHT	CG POSITION	ALTITUDE
		LB	PIAC	FT
○	2A	43,200-48,400	13.6-11.6	7500
◐	3B1A	48,500	9.0	5000
△	2B2	49,300	16.0	5000

Partially shaded symbols are requirements of SD-561-1
shaded symbols denote SAS OFF.
Flags denote maneuver direction

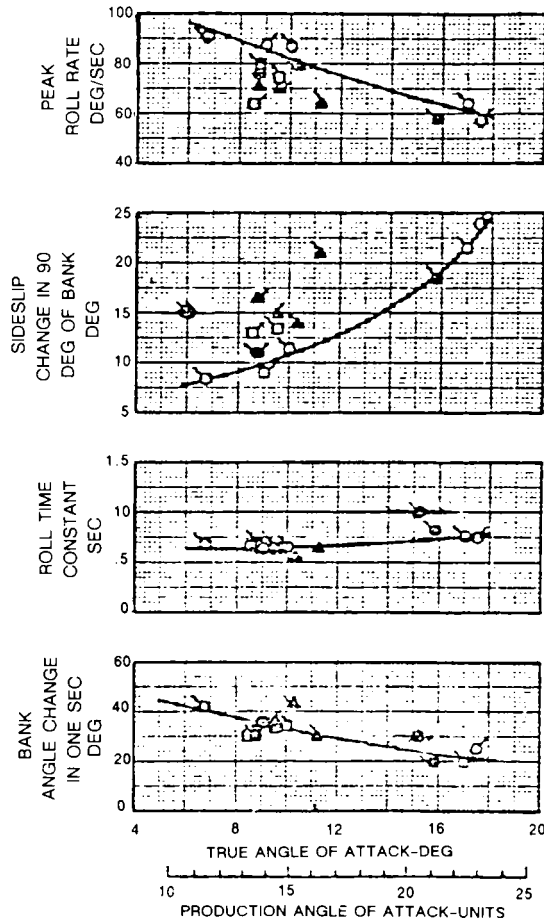

Loading 2A
Four AIM-7 Missiles
Loading 3B1A
Two AIM-54 Missiles
Two AIM-7 Missiles
Two AIM-9 Missiles
Loading 2B2
Four AIM-7 Missiles
Two AIM-9 Missiles

FIGURE 181. F-14A rolling performance in configuration PA; DLC on (from Navy Rpt No. SA-C7R-75).

MIL-STD-1797A
APPENDIX A

CAS-ON
PRCA-AUTO
0.8 to 1.0 Mach Number
Dynamic Pressure ≤ 400 psf

Notes:

- *Fairings were taken from AFFTC-TR-76-48 and represent TF-15A flight test results*
- *Shaded symbols denote power approach configuration obtained from bank-to-bank rolls of 90 deg to -90 deg*

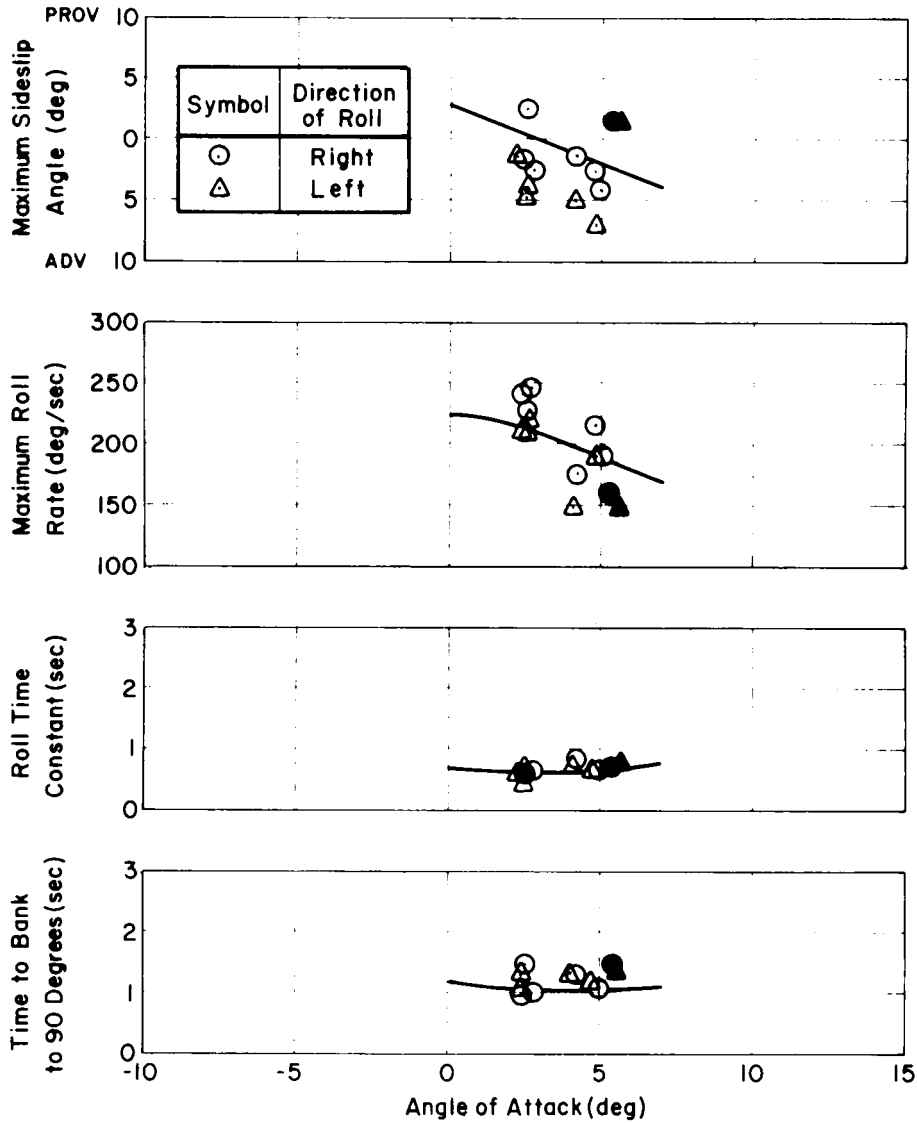

FIGURE 182. F-15C aileron roll characteristics (from AFFTC-TR-80-23).

The difference in time to bank for left versus right rolls (see figures 183 and 184) was due to a lateral trim offset in the F/A-15A tested- "The large positive [control stick] deflection required for 1-g level flight significantly reduced the amount of control deflection change available to command a right roll as opposed

MIL-STD-1797A
APPENDIX A

to a left roll." While figure 183 shows Level 1 roll performance at low airspeeds, fine, precise control was found to be sluggish: "the pilot was unable to perform the fine tracking task at 200 KCAS/2g [15,000 ft altitude] (HQR - 7).... The sluggish lateral response characteristics...rapidly led to an out-of-phase condition and resultant nondivergent lateral PIO." It should be noted, however, that there may have been other problems resulting from T_R (4.5.1.1) or τ_e (4.5.1.5).

F/A-18A roll performance in PA (landing and takeoff) configurations is seen to be marginally Level 1 (figure 185) below 180 kt, i.e., the responses are very close to the required 30 deg in 1.1 sec. See the discussion immediately above for recent experience with the roll requirements. Because these requirements are both difficult and costly to meet, they have generated much argument. Aircraft with large lateral stability ($C_{l\beta}$) at high angle of attack may need more roll control than specified separately here and in the sideslip requirements of 4.5.8.2 and 4.5.8.3 because of sensitivity to lateral gusts. In addition, asymmetric loadings (fuel, stores; intentional or the result of failure or malperformance) should be taken into account.

The roll performance of the YF-16, shown in table XXXIV and figure 186, is comparable with the capabilities of present generation USAF fighter aircraft and is seen to be fairly good in comparison to the roll control power requirements of tables XXX and XXXI, but less than some of the requirements. A roll damper which allows it to stop precisely, more quickly than it can start rolling, appears partly responsible for the satisfactory pilot ratings. F-16 roll performance in 360 deg rolls for the "CR (cruise) configuration" (figure 187) compares quite well with the table XXXI requirements for Flight Phase CO. The F-16 was Level 2 below 180 kt, Level 3 below 155 kt in Power Approach (figure 188). According to AFFTC-TR-79-10, "the pilots were pleased with the F-16A/B CR configuration roll performance. PA configuration roll performance was acceptable."

TABLE XXXIV. YF-16 roll performance (from AFFTC-TR-75-15).

q	V _c	M	H _c	s	ρ_{max}	T ₉₀	T ₃₆₀	$\delta_{a_{av}}$	$\delta_{r_{max}}$
(Psf)	(KCAS)		(ft)	(deg)	(deg/sec)	(sec)	(sec)	(deg)	(deg)
70	135	0.45	36K	14	-155	1.60	3.55	+17	+12
270	300	0.79	30K	5	+187	1.14	2.65	-10	-2
1140	650	1.58	30K	2	-168	1.24	2.90	+10	-4

REQUIREMENT LESSONS LEARNED

Complicating factors in roll performance include adverse or favorable yaw, yaw due to rolling (4.5.1.4, 4.6.2) and cross-axis coupling (4.8.1), control rate limiting may significantly decrease the roll performance. Except for configurations with low $|\phi/\beta|$ and low N_{δ_a} , the roll response may be significantly contaminated by the dutch roll mode. Although crossfeed to the rudder can help, the required crossfeed varies with angle of attack.

MIL-STD-1797A
APPENDIX A

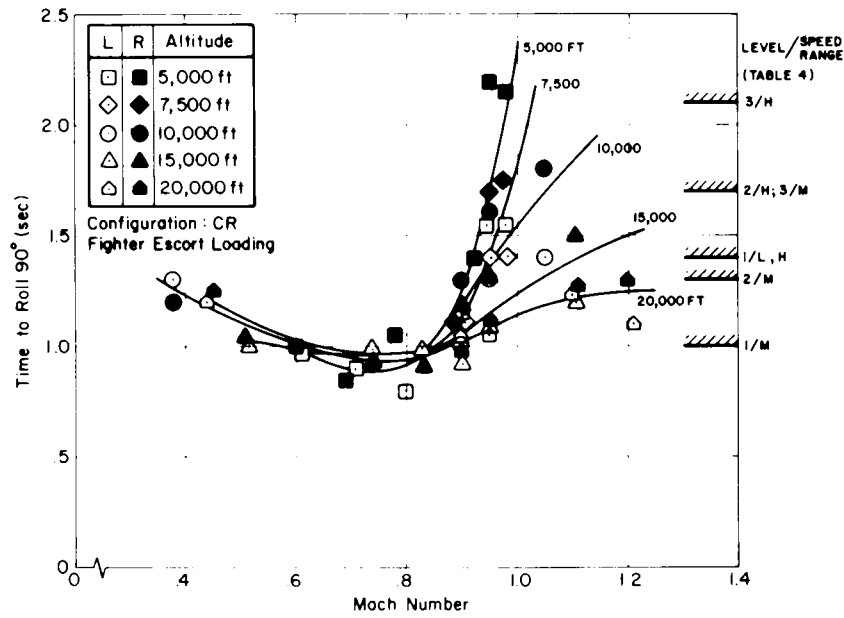

FIGURE 183. Time to roll 90° versus mach for F/A-18A (Navy Rpt No. SA-14R-81).

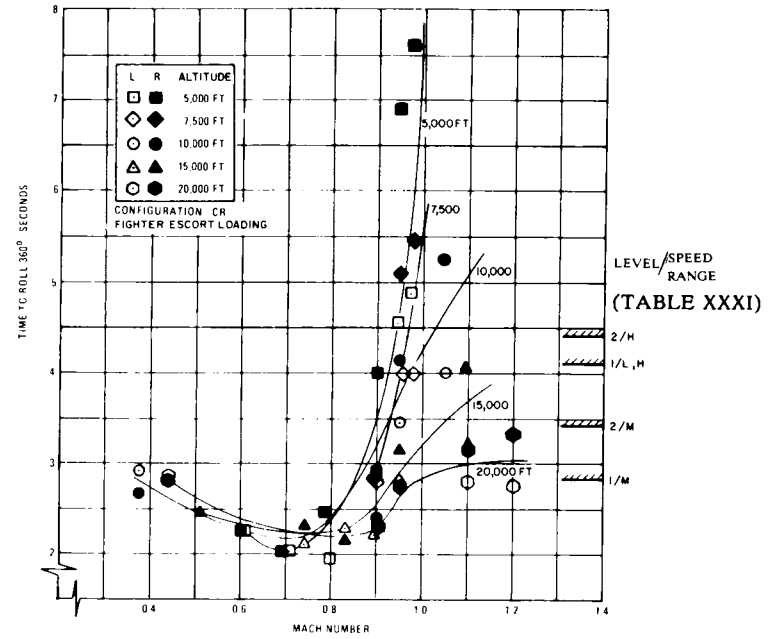

FIGURE 184. Time to roll 360° versus mach for F/A-18A (Navy Rpt No. SA-14R-81).

MIL-STD-1797A
APPENDIX A

MODEL F/A-18 A AIRPLANE

CONFIGURATION: PA AND PA ½
FIGHTER ESCORT LOADING
ALTITUDE: 5000 FT

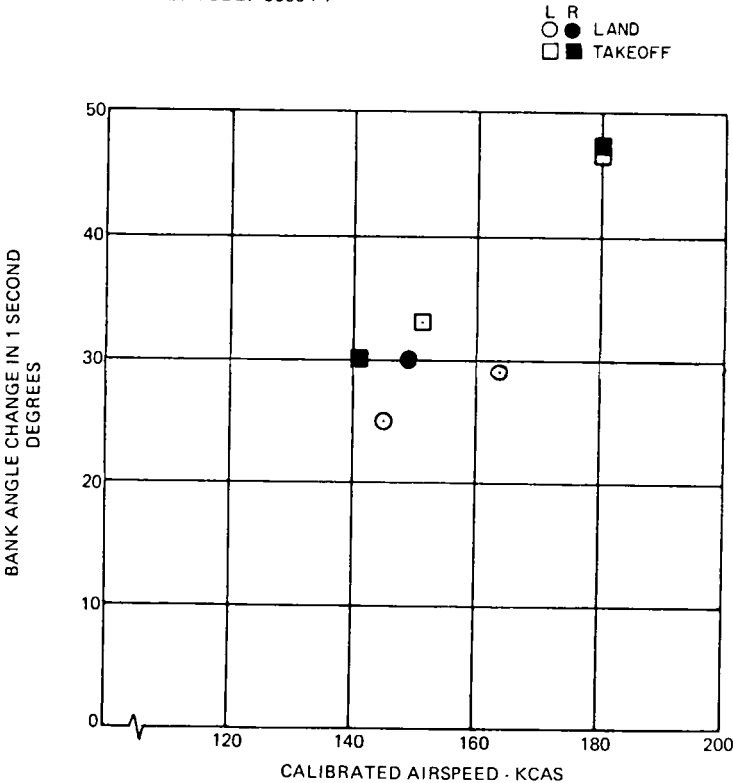

FIGURE 185. Roll performance characteristics in configuration PA (from Navy Rpt No. SA-14R-81).

MIL-STD-1797A
APPENDIX A

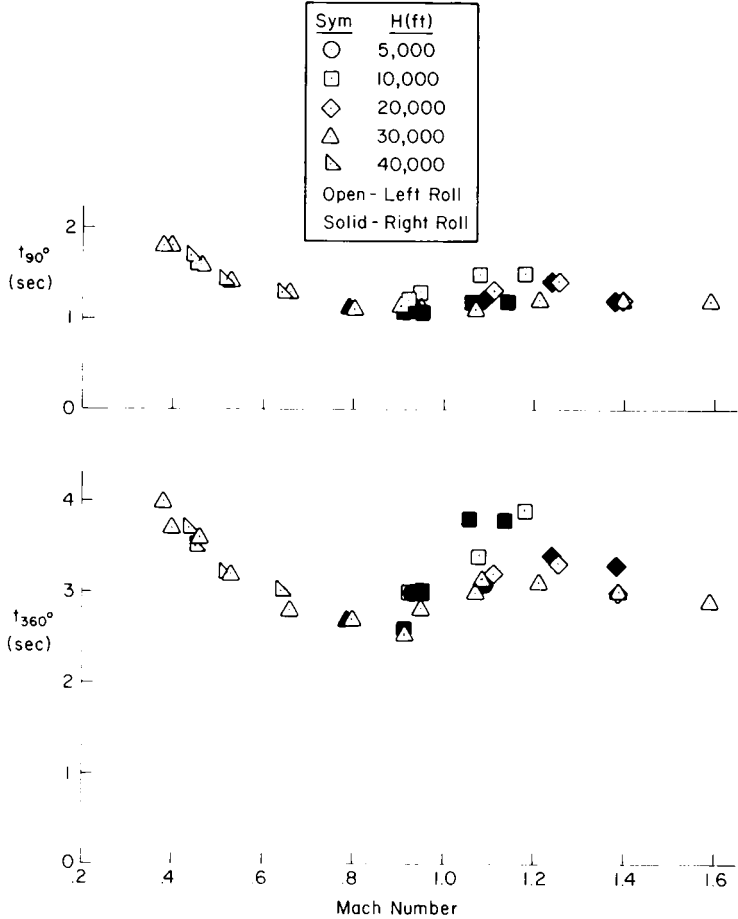

FIGURE 186. YF-16 rolling performance in cruise configuration; AFFTC-TR-75-15.

MIL-STD-1797A
APPENDIX A

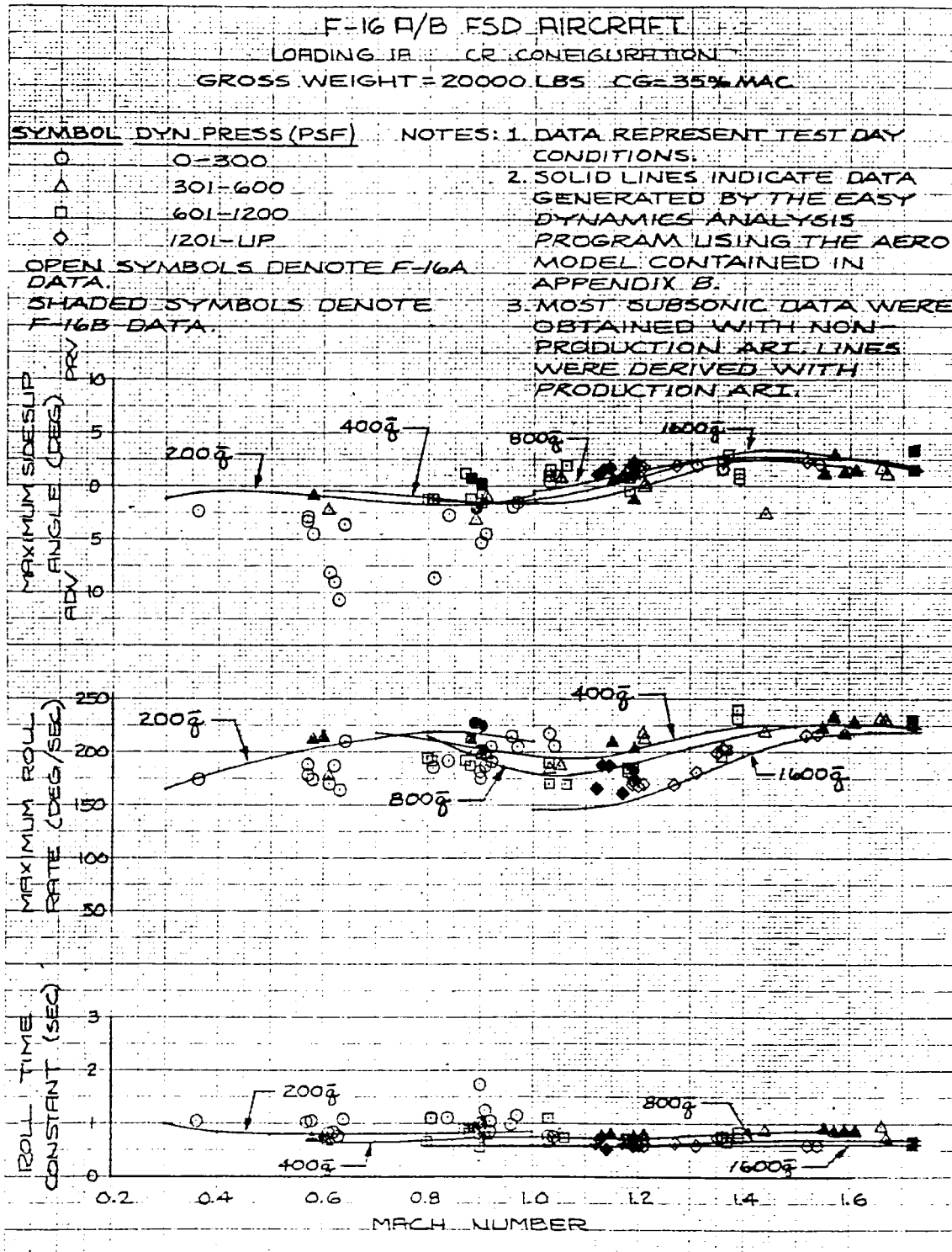

FIGURE 187. Roll performance summary (from AFFTC-TR-79-10).

MIL-STD-1797A
APPENDIX A

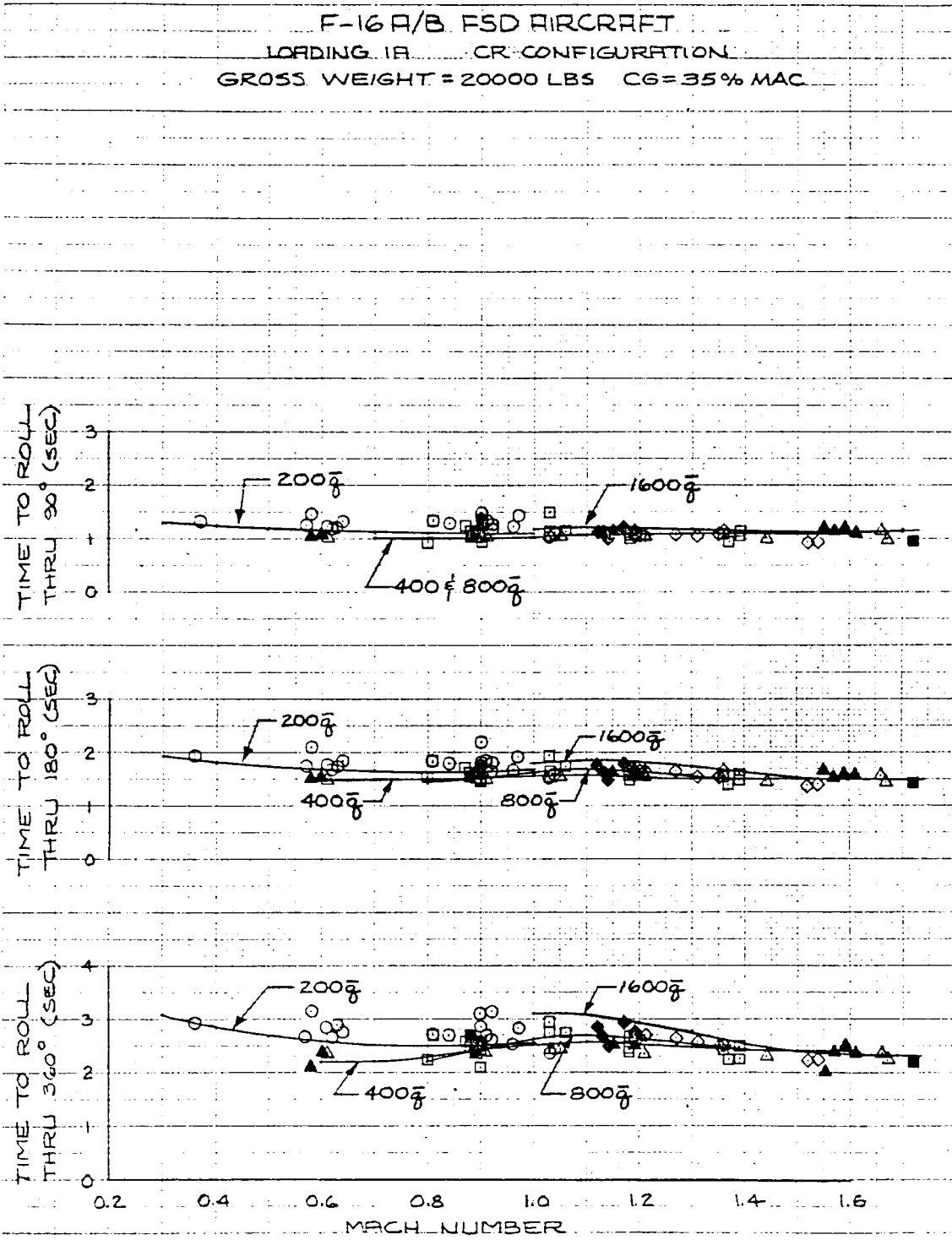

FIGURE 187. Roll performance summary (from AFFTC-TR-79-10)-Continued.

MIL-STD-1797A
APPENDIX A

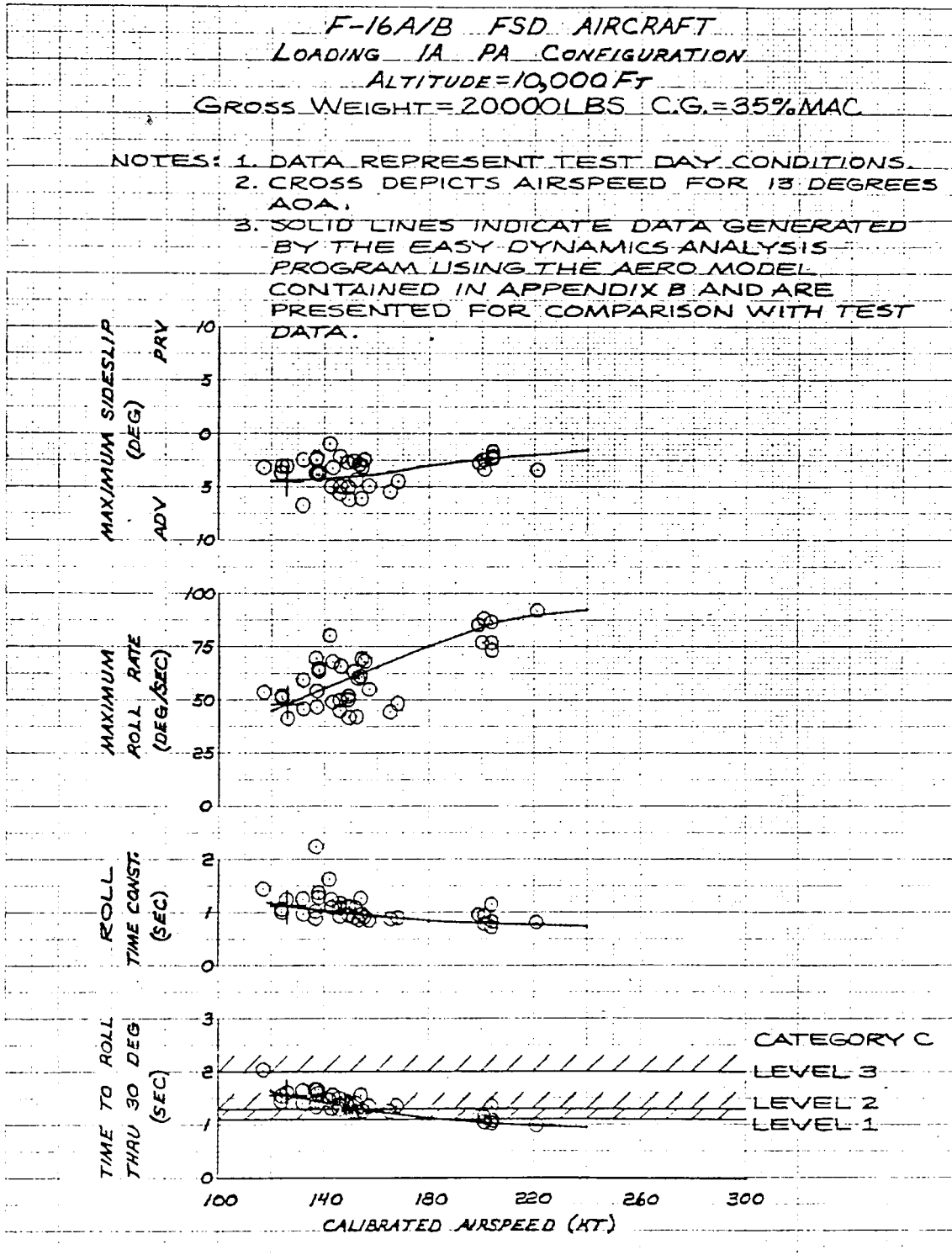

FIGURE. 188. Roll performance summary (from AFFTC-TR-79-10).

5.5.8 Roll axis control power-verification

5.5.8.1 Roll axis response to roll control inputs-verification.

Verification shall be by analysis, simulation and flight test.

VERIFICATION RATIONALE(5.5-8.1)

The requirements apply throughout the normal load factor, as well as the airspeed and altitude range, of each flight envelope. Sharp step controller force inputs get the highest performance, and the technique is to roll through the specified bank-angle change. In buildups, a chain is sometimes used to allow quick, accurate partial deflection of the controller. While a bank-and-stop or sidestep maneuver might be somewhat more representative of operational use, rolling through the given bank angle gives more consistent, repeatable flight test results. Nevertheless, these other maneuvers and also gust response should also be evaluated qualitatively in the course of simulation and flight testing.

VERIFICATION GUIDANCE

Some of these requirements are divided into airspeed regions or relaxed for heavy loadings along the wing. These provisions indicate some important critical factors. Slow surface actuators will lower the roll performance. Note how this effect was approximated on figure 172; it is better, of course, to do the analysis more exactly (Use more degrees of freedom and an actual ramp corresponding to the actuator rate limit) Surfaces used for both roll and pitch may have to give priority to pitch control, thus at some conditions limiting the amount available for roll.

For a step aileron input, with one degree of freedom (implying that $\omega_\phi = \omega_d$, $\zeta_\phi = \zeta_d$ and $T_S \gg T_R$)

$$\phi(t) = \frac{P_\infty}{-L'_p} \left(e^{L'_p t^*} - L'_p t^* - 1 \right)$$

where, accounting for any hinge-moment limitations and approximating a ramped rate-limited step command by a step at the halfway point,

$$t^* = t - \tau_e - 1/2 \delta_{a_{step}} / \delta_{a_{max}}$$

$$L'_p = \frac{L_p + N_p I_{xz} / I_x}{1 - I_{xz}^2 / (I_x I_z)}$$

$$L_p = \frac{\rho V g}{4(W/S) k_x^2} C_{l_p}$$

$$N_p = \frac{\rho V g}{4(W/S) k_z^2} C_{n_p}$$

$$k_x^2 = I_x / (mb^2), \quad k_z^2 = I_z / (mb^2)$$

Also, accounting somewhat for induced sideslip, the steady roll rate is given by

MIL-STD-1797A
APPENDIX A

$$p_{\infty} \approx \frac{-2V C'_{\ell}(\delta_{a_{\max}})}{b C'_{\ell p}} \left[\frac{1 - \frac{C'_{n\delta_a} C'_{\ell\beta}}{C'_{\ell\delta_a} C'_{n\beta}}}{1 - \frac{C'_{np} C'_{\ell\beta}}{C'_{\ell p} C'_{n\beta}}} \right] \approx \frac{2V C'_{\ell}(\delta_{a_{\max}})}{b C'_{\ell p}} \text{rad/sec}$$

where

$$C'_{\ell_i} = \frac{C_{\ell_i} + C_{n_i} I_{xz}/I_z}{1 - I_{xz}^2/(I_x I_z)}, \quad C'_{n_i} = \frac{C_{n_i} + C_{\ell_i} I_{xz}/I_z}{1 - I_{xz}^2/(I_x I_z)}$$

Low speed, high angle of attack (high lateral stability and large aileron yaw) and high dynamic pressure (aeroelastic deformation) are common critical flight conditions.

VERIFICATION LESSONS LEARNED

Since a true step is virtually impossible to achieve in practice, time may be measured from the midpoint of the control input transient, as sketched, for the most abrupt input feasible.

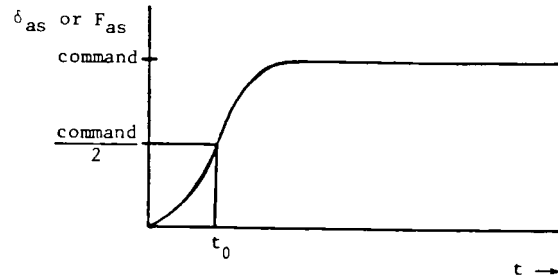

In 360 deg rolls, even test pilots tend to relax the control input before reaching 360 deg bank.

At high angle of attack, pilots of some aircraft (F-4 and F-18 for example) use the rudder pedals to roll, because of the large adverse yaw due to the roll control effectors. Use of an aileron-rudder interconnect, or rudder-to-aileron interconnect, may be necessary to provide satisfactory roll performance at high angles of attack.

MIL-STD-1797A
APPENDIX A

4.5.8.2 Roll axis control power in steady sideslips.

For Levels 1 and 2, positive effective dihedral (right roll control for right sideslip and left roll control for left sideslip) shall never be so great that more than _____ percent of roll control power available to the pilot is required for sideslips which might be encountered in service employment.

REQUIREMENT RATIONALE (4.5.8.2)

This requirement assures adequate roll power for operation in sideslips, with some additional control margin to correct for turbulence, etc.

REQUIREMENT GUIDANCE

The related MIL-F-8785C requirement is paragraph 3.3.6.3.2.

Recommended value: no more than 75 percent of roll power should be required.

This requirement places a limit on dihedral effect in order to assure controllability. The 25 percent margin has generally proved sufficient, although it does not explicitly address gust sensitivity.

The pilot must be able to maneuver and to cope with disturbances, so a control margin is required. The type of controller relates directly to aircraft usage; that is, the size of sideslip that might be experienced in service employment, which varies with aircraft type as well as details of design missions. This requirement alone, however, is not enough to assure that excessive lateral stability will not make the vehicle overly sensitive to lateral gusts.

REQUIREMENT LESSONS LEARNED

5.5.8.2 Roll axis control power in steady sideslips--verification.

Verification shall be by analysis, simulation and flight test.

VERIFICATION RATIONALE

Analysis should reveal any large dihedral effect. If compliance with any of the sideslip requirements is doubtful or marginal, flight testing will need to be more extensive. Otherwise, analytical demonstration verified through qualitative flight testing should be sufficient.

VERIFICATION GUIDANCE

In steady, straight sideslips, for a symmetrical aircraft,

$$\frac{d\delta_a}{d\beta} = \frac{-C_{\ell\beta} + C_{n\beta} C_{\ell\delta_r} / C_{n\delta_r}}{C_{\ell\delta_a} \left(1 - \frac{C_{n\delta_a} C_{\ell\delta_r}}{C_{\ell\delta_a} C_{n\delta_r}} \right)}$$

(See 4.5.5 guidance).

VERIFICATION LESSONS LEARNED

MIL-STD-1797A
APPENDIX A

4.5.8.3 Roll axis control power in crosswinds.

Roll control shall be sufficient to perform the following tasks:

- a. On a dry surface it shall be possible to taxi at any angle to a _____ kt wind.
- b. Roll control power, in conjunction with other normal means of control, shall be adequate to maintain a straight path during the takeoff run and landing rollout in crosswinds up to those specified in 4.6.4.
- c. Roll control power shall be adequate to maintain wings level with up to _____ deg of sideslip in the power approach. For Level 1 this shall require not more than _____ percent of the control power available to the pilot.
- d. Following sudden asymmetric loss of thrust from any factor during takeoff, approach, landing and low-altitude parachute extraction, the aircraft shall be safely controllable in roll in the crosswinds of 4.6.4 from the unfavorable direction.

REQUIREMENT RATIONALE (4.5.8.3)

Roll control power must be available for maneuvering and countering atmospheric disturbances while sideslipping, in the air and on the ground while getting to and from the runway.

REQUIREMENT GUIDANCE

The related MIL-F-8785C requirements are paragraphs 3.3.7.1, 3.3.7.2, 3.3.7.3 and 3.3.9

Recommended values:

Wind speed for taxi:

Class I aircraft: 35 kt

Class II, III, and IV aircraft: 45 kt

For sideslip angles of 10 deg in the power approach, not more than 75 percent of available control power should be required.

The closely related yaw-axis requirement is 4.6.6.1.

The conditions under which it must be possible to taxi have been specified since there is generally no point in being able to take off or land in a given crosswind if the aircraft cannot be taxied. The wind speeds specified are a compromise between what is desired and what is reasonable to require. At some point while taxiing, the aircraft will likely be broadside to the wind, even though the wind tends to be somewhat aligned with the active runway.

Additionally, ability to roll moderately in operational sideslipping, including compensating for a gust disturbance or losing an engine at a critical time, is necessary if flight-safety operational restrictions are to be minimized. Roll control available to the pilot is called out in recognition that flight control system features, for example stability augmentation, may give the pilot less than MI authority at times

4.5.9.5.3 and 4.5.9.5.4 cover similar requirements in terms of roll control forces, and 4.6.6.1 covers yaw control power in these conditions. All should be considered as a group with consistent requirements throughout.

REQUIREMENT LESSONS LEARNED

5.5.8.3 Roll axis control power in crosswinds-verification.

Verification shall be by analysis, simulation and ground and flight test.

VERIFICATION RATIONALE (5.5.8.3)

As discussed above, compliance with these requirements will be demonstrated in the course of verification against several other requirements. Crosswinds will have to be taken advantage of as they come along.

VERIFICATION GUIDANCE

For the first requirement, ground taxi should be performed in winds that are at least close in average magnitude to those specified. Choice of wind conditions should account for variability and gustiness. Dihedral effect will tend to repress the downwind wing.

For discussion of the second and third requirements, the reader is referred to guidance for 5.5.9.5.3.

For the last of these requirements, as for some other requirements on asymmetric thrust (and on crosswinds), generally takeoffs are planned to account for possible loss of an engine; thus reaching any control limit may restrict performance even in normal crosswind takeoff or landing. Crosswind landings performed to demonstrate compliance with 4.5.6 must include simulated asymmetric thrust, with the crosswind blowing in the unfavorable direction (i.e., from the direction of the bad engines). Operation with an engine failure will in most aircraft be Level 2, which implies a pilot rating of only 6-1/2 or better in a 10 kt crosswind. It is clear that the subjective nature of this requirement (safely controllable) allows considerable leeway in its application. Asymmetric loss of thrust may be caused by many factors including engine failure, inlet unstart, propeller failure or propeller-drive failure.

In a steady crosswind of magnitude C at 90 deg to the runway, for takeoff and landing a pilot must align his flight path with respect to the air mass so that it has a component normal to the runway that exactly cancels his drift from the crosswind. Denoting the required angle to the runway by X and the resultant airspeed by V_a. In the nearly level flight and attitude he must make

$$V_a \sin \chi, + C = 0$$

or

$$\chi = \sin^{-1} (-C/V_a)$$

so that the ground speed, V (the inertial velocity) will be along the runway (first sketch). He can do this entirely by crabbing, with zero sideslip; in that case $\psi=\chi$, the yaw deviation angle. When $\chi=0$ the alignment must be entirely by sideslip: $\chi=\beta$ for small ϕ , with the aircraft pointed down the runway centerline but having a side (y) velocity with respect to the air mass equal and opposite to C (assuming that $\cos \phi=1$). The general case, with both crab and sideslip, is illustrated in the second sketch. There it is evident that

$$\chi = \psi + \beta$$

so that

$$\beta = \sin^{-1} (-C/V_a) - \psi$$

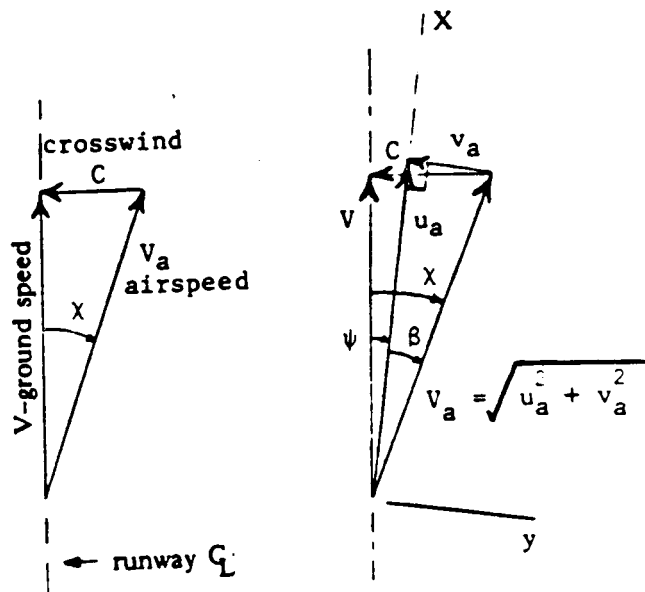

MIL-STD-1797A
APPENDIX A

The third sketch shows arbitrary orientations, when the inertial flight path (V_G) is aligned with the runway.

$$\frac{W}{\sin \varepsilon} = \frac{V_a}{\sin \sigma} = \frac{V_G}{\sin(\psi_w - \psi_G)}$$

$$\chi_a = \psi_G - \varepsilon = \psi_G - \sin^{-1} \left[\frac{W}{V_a} \sin(\psi_w - \psi_G) \right]$$

Using radian measure,

$$\chi_a \approx \psi_G - \frac{W}{V_a} \sin(\psi_w - \psi_G)$$

it can be shown that in stability axes ($\alpha = 0$),

$$\begin{aligned} \sin \beta &= \sin(\chi_a - \psi) \cos \gamma / \cos \phi \\ &\approx \sin(\chi_a - \psi) \end{aligned}$$

for the usually small γ and ϕ . Then

$$\beta \approx (\psi_G - \psi) - \frac{W}{V_a} \sin(\psi_w - \psi_G)$$

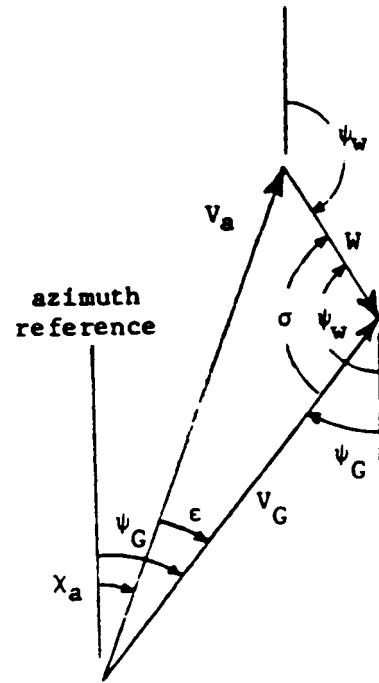

Two extremes of crosswind compensation are wings-level crabbing and sideslipping with zero crab. In the crab, $\beta = 0$ and $\psi = \chi_a$. In the sideslip, to the left (negative) for the case shown--nose to the right of V_a :

$$\beta = -\varepsilon$$

That is,

$$\psi = \chi_a + \varepsilon$$

Heading is along the ground track and sideslip is

$$\beta = -(\psi_w - \psi_R) W/V_a$$

VERIFICATION LESSONS LEARNED

4.5.8.4 Roll axis control power for asymmetric thrust.

Not more than _____ percent of the roll control available to the pilot shall be needed in meeting the steady-state and dynamic requirements of 4.6.5.1, 4.1.11.4 and 4.6.6.2 for asymmetric loss of thrust from any single factor.

REQUIREMENT RATIONALE (4.5.8.4)

For flight safety, a roll control margin must be provided for gentle maneuvering and for countering gusts while coping with a propulsive failure.

REQUIREMENT GUIDANCE

The related MIL-F-8785C requirement is paragraph 3.3.9.2.

Recommended values: Roll power required should be not more than 75 percent. This amount of available roll control is based on judgment and experience, since no hard data are available. See also 4.5.8.3d. The 25 percent margin, though arbitrary, has generally proved sufficient to assure safety of flight when an engine fails. A rational alternative would be to apply a gust at least commensurate with the expected mean value of turbulence ($a = 2.9$ ft/sec., AFFDL-TR-69-72) at the critical time, but that added complication seems unwarranted.

REQUIREMENT LESSONS LEARNED

This requirement may well determine the minimum approach speed for a powered-lift aircraft. While the YC-15 relied on the pilot to retain control, the YC-14 incorporated automatic reconfiguration and control inputs to handle thrust asymmetry. The unlikely event of two critical engines failing has occurred in service often enough to warrant guarding against the resultant loss of an aircraft

5.5.8.4 Roll axis control power for asymmetric thrust -verification.

Verification shall be by analysis simulation, and flight test.

VERIFICATION RATIONALE (5.5-8.4)

Compliance will be determined in connection with 5.6.4.

VERIFICATION GUIDANCE

See 5.6.4. For operation on the ground, this requirement is usually not a critical design factor. While airborne, the necessary steady roll control deflection is

$$\delta_a = \frac{-(C_{\ell\beta} - C_{n\beta} C_{\ell\delta_r} / C_{n\delta_r})\beta - C_{\ell}(\Delta T) + C_n(\Delta T)C_{\ell\delta_r} / C_{n\delta_r}}{C_{\ell\delta_a} \left(1 - \frac{C_{n\delta_a} C_{\ell\delta_r}}{C_{\ell\delta_a} C_{n\delta_r}} \right)}$$

where

$$\beta \doteq \frac{-C_{L1}\phi + [C_n(\Delta T) - C_{\ell}(\Delta T)C_{n\delta_a} / C_{\ell\delta_a}]C_{y\delta_r} / C_{n\delta_r}}{C_{y\beta} - \left(1 - \frac{C_{n\delta_a} C_{\ell\beta}}{C_{\ell\delta_a} C_{n\beta}} \right) \frac{C_{y\delta_r}}{C_{n\delta_r}} C_{n\beta}}$$

MIL-STD-1797A
APPENDIX A

VERIFICATION LESSONS LEARNED

MIL-STD-1797A
APPENDIX A

4.5.8.5 Roll axis control power in dives and pullouts.

Roll control power shall be adequate to maintain wings level without retrimming, throughout the dives and pullouts of 4.2.8.6.3.

REQUIREMENT RATIONALE (4-5.8.5)

For safety, roll control power must be adequate to perform any dive maneuvers, not only within the Service Flight Envelope but also throughout the Permissible Flight Envelope. Outside the Service Flight Envelope, the quantitative requirements of 4.5.8.1 do not apply.

REQUIREMENT GUIDANCE

The related MIL-F-8785C requirement is paragraph 3.3.8. The qualitative nature of this requirement makes it straightforward to apply. Transonic flow phenomena have been responsible for some asymmetric moments.

REQUIREMENT LESSONS LEARNED

F-100 aircraft were lost when the aerodynamically-operated automatic leading-edge slats stuck closed asymmetrically during pullouts from dive-bombing runs. Friction, binding and sideslip were possible causes.

5.5.8.5 Roll axis control power in dives and pullouts-verification.

Verification shall be by analysis, simulation, and flight test.

VERIFICATION RATIONALE (5.5.8.5)

Verification will be in connection with the verification of 4.2.8.6.3. The qualitative nature of this Ask requirement makes it straightforward to apply.

VERIFICATION GUIDANCE

See 5.2.8.6.3. Also, transonic flow phenomena have been responsible for some asymmetric moments.

Aeroelasticity tends to reduce roll control effectiveness at high dynamic pressure. Some other possible contributors to reduced roll effectiveness are compressibility effects, high hinge moments and, with a combined pitch/roll control surface, the pitch control input.

VERIFICATION LESSONS LEARNED

MIL-STD-1797A
APPENDIX A

4.5.8.6 Roll axis control power for asymmetric loading.

When initially trimmed with each asymmetric loading at any speed in the Operational Flight Envelope, and also for hung stores and all asymmetries encountered in normal operation, it shall be possible to maintain a straight flight path throughout the Operational Flight Envelope. For Category A Flight Phases, roll control power with these asymmetric loadings shall be sufficient to hold the wings level at the maximum load factors of 4.2.7.2 with adequate control margin (4.1.11.5).

REQUIREMENT RATIONALE (4.5.8-6)

This requirement is necessary for service employment. It has flight safety implications.

REQUIREMENT GUIDANCE

The related MIL-F-8785C requirement is paragraph 3.3.4.1.2.

The scope has been expanded to cover all applicable Flight Phases. Normal operation commonly encounters the selective firing of weapons or release of stores, and hung stores.

REQUIREMENT LESSONS LEARNED

A critical case for the L-19 was the addition of a wire-laying mission involving carriage of a large reel under one wing. Some airplanes--the F-15 is a recent example--have been prone to develop significant fuel asymmetries due to small differences in head pressure between left and right wing fuel pumps and other fuel system tolerances. Dive pullouts involving elevated load factors will accentuate the effects of loading asymmetries. Some F-100s were lost from asymmetric operation of leading-edge slats (nonpowered, aerodynamically operated on their own, without pilot action) in dive-bombing pullouts.

5.5.8.6 Roll axis control power for asymmetric loading-verification.

Verification shall be by analysis simulation and flight test.

VERIFICATION RATIONALE (5.5.8.6)

Verification is a matter of flying at the envelope boundaries with the contractually-specified and encountered asymmetric loadings.

VERIFICATION GUIDANCE

Low airspeed and high normal load factor will generally be critical; the level of static stability may affect the critical conditions. See the equations for asymmetric thrust.

VERIFICATION LESSONS LEARNED

4.5.9 Roll axis control forces and displacements

The requirements of this section cover broad areas for forces and displacements of roll controllers. Many of the requirements (most specifically, the force limits of 4.5.9.5) set absolute upper limits on allowable control forces in various maneuvers. As with the pitch axis forces of 4.2.8, there is some concern as to whether the limits are reasonable for continuous maneuvering, and whether they are attainable by female pilots. While any substantiating data are scarce, there are some available dealing with maximum forces for single-application tasks (Human Engineering Guide to Equipment Design and AFAMRL-TR-81-39). The purpose of this discussion is to briefly review these data. Since there are many variables involved in developing adequate controller characteristics, no attempt has been made to set any new requirements based upon this information; it is intended only as information.

Figure 189 shows the effect of arm/stick geometry on maximum applied force to the left and to the right for the 5th percentile male, and figure 190 shows the effect of upper arm angle on maximum applied force to the left and to the right for the 5th and 95th percentile male. The data in these illustrations are from Human Engineering Guide to Equipment Design. Single test points from a more recent study by McDaniel (AFAMRL-TR-81-39) are shown on figure 189 as a comparison between male and female strength characteristics for operating an aircraft control stick. Figures 189b and 189c show that the maximum applied force to the left and to the right (depending on arm/stick geometry) varies and is not symmetric. The difference in strength characteristics between men and women (single points from AFAMRL-TR-81-39) shown on figures 189b and 189c is almost a factor of two. There is also a large difference in the forces attained by the men in the two tests (e.g., in figure 189b the data show about 8 lb at the same location where the AFAMRL-TR-81-39 tests show 35 lb). The reason for this difference is not known.

The 5th, 50th, and 95th percentiles of maximum forces exerted on an aircraft control stick by 61 men and 61 women (from AFAMRL-TR-81-39) are summarized in table XXXV.

Figure 191 illustrates the effect of arm position and wheel angle on maximum applied force to the left and to the right for the 5th percentile male.

Human Engineering Guide to Equipment Design discusses one- vs. two-handed operation of controls and some general principles of control design; for example:

...Controls requiring large forces should be operated with two hands (which, for most controls, about doubles the amount of force that can be applied) depending on control type and location and on the kind and direction of movement as follows:

- a. When two hands are used on wheel controls, rotational forces are effectively doubled in most cases
- b. With two hands on stick or lever controls located along the body midline ... push right or left is increased about 50%
- c. When two hands are used on stick or lever controls located on either side of the body midline, at or beyond the shoulder..., pull right on controls located to the left is slightly better with two hands than with only the right hand, and push right on controls located to the right is slightly better with two hands than with only the left hand... For controls requiring single applications of force or short periods of continuous force, a reasonable maximum resistance is half of the operator's greatest strength. For controls operated continuously, or for long periods, resistances should be much lower.

MIL-STD-1797A
APPENDIX A

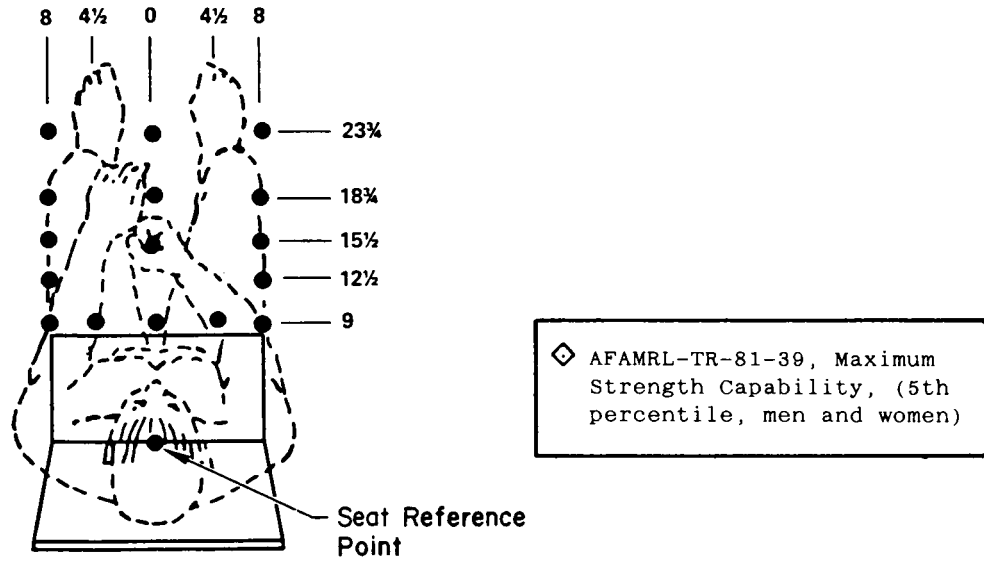

a) Physical Layout For Stick Tests
(stick 13 1/2 inches above seat Reference point)

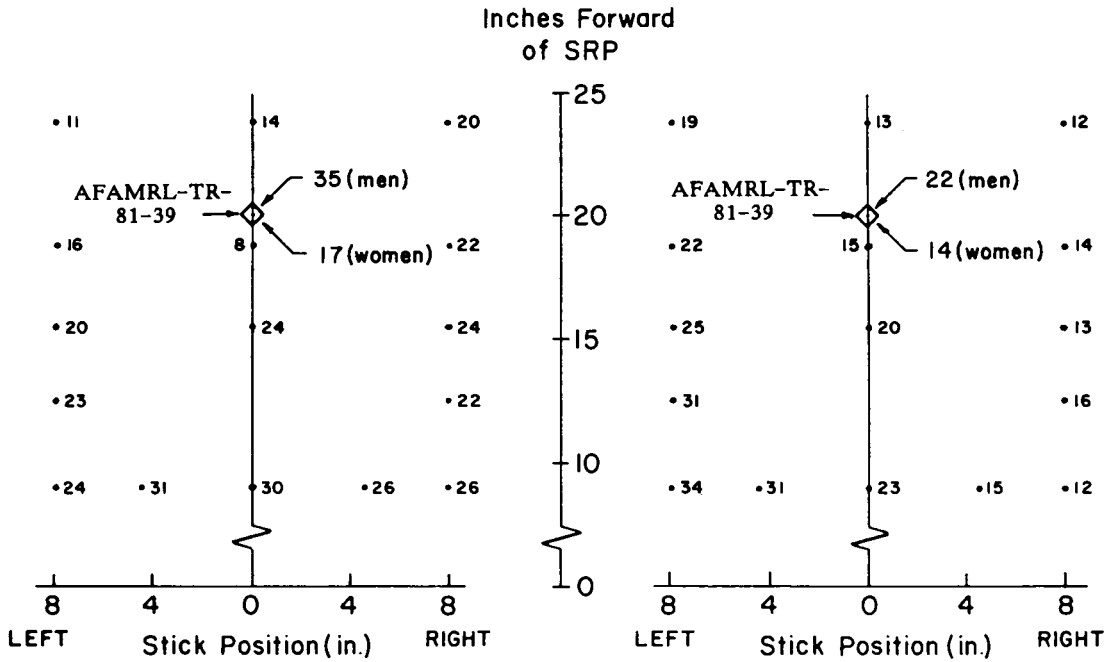

b) Maximum Force to the Left (lb)

c) Maximum Force to the Right (lb)

FIGURE 189. Effect of arm/stick geometry on maximum applied force to the left and to the right by the right arm for the 5th percentile male (Human Engineering Guide to Equipment Design).

MIL-STD-1797A
APPENDIX A

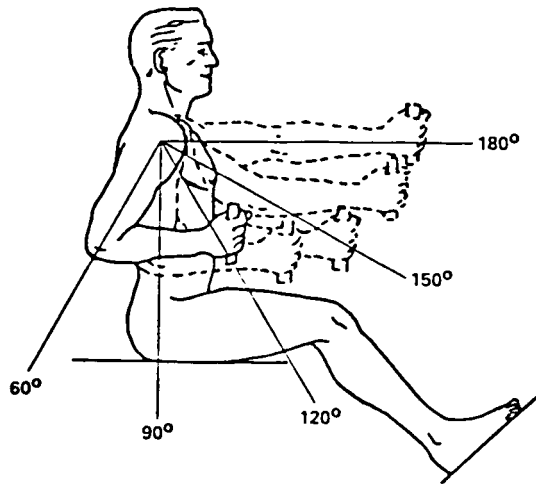

a) Physical Layout Fortest

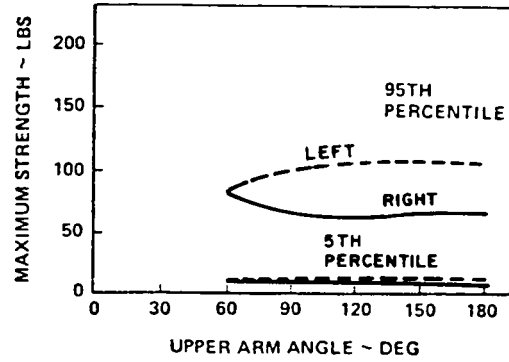

b) Maximum Strength vs. Upper Arm Angle

FIGURE 190. Effect of upper arm angle on maximum applied force to the left and to the right for the 5th and 95th percentile male (from Human Engineering Guide to Equipment Design)

TABLE XXXV. Maximum forces exerted on aircraft control stick (lb) by 61 men and 61 women (AFAMRL-TR-81-39).

CONTROL STICK DIRECTION	MEN			WOMEN		
	PERCENTILE			PERCENTILE		
	5 th	50 th	95 th	5 th	50 th	95 th
Stick left	35	52	74	17	26	35
Stick Tight	22	35	43	14	19	18

MIL-STD-1797A
APPENDIX A

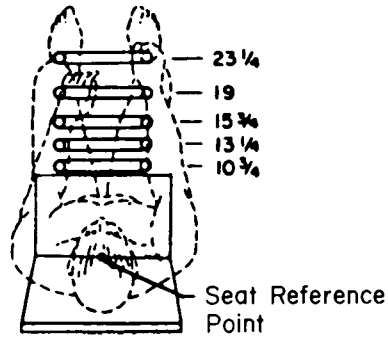

a) Physical layout for Wheel Force Tests
(wheel 18 inches above seat reference point)

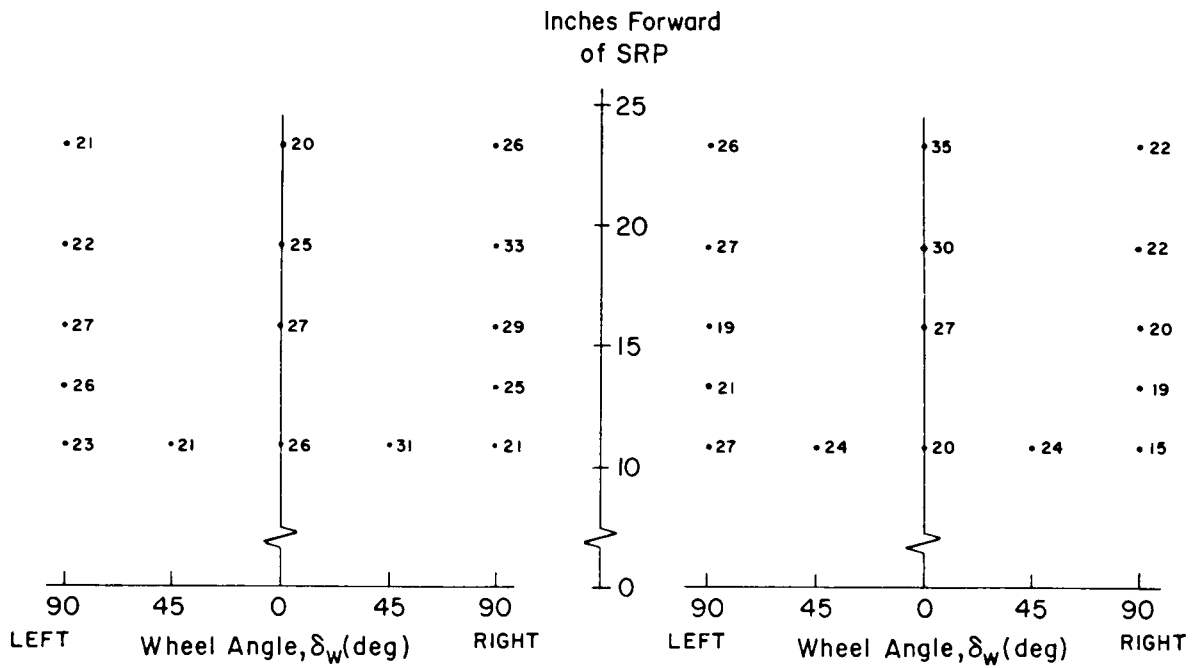

b) Maximum Force to the Left (lb)

c) Maximum Force to the Right (lb)

FIGURE 191. Effect of arm position and wheel angle on maximum applied force to the left and to the right for the 5th percentile male (Human Engineering Guide to Equipment Design).

MIL-STD-1797A
APPENDIX A

4.5.9.1 Roll control displacements.

For aircraft with wheel controllers, the wheel throw necessary to meet the roll performance requirements specified in 4.5.8 through 4.5.8.6 shall not exceed _____ degrees in either direction. For aircraft with stick controllers, no physical interference with the pilot's body, seat, or cockpit structure shall prevent the pilot from obtaining full control authority.

REQUIREMENT RATIONALE (4.5.9.1)

The allowable control wheel angular displacement must be limited to allow proper control in both pitch and roll and to bound the time and effort needed to reach sufficient wheel travel.

REQUIREMENT GUIDANCE

The related MIL-F-8785C requirement is paragraph 3.3.4.5.

Recommended wheel displacement: 60 deg. For completely mechanical systems the requirement may be relaxed to 110 deg.

An upper limit on allowable wheel throw helps assure that undue contortions will not be required to fly the aircraft. If the throw is too small, of course, the aircraft can be overly sensitive to small inputs; however, from a comfort (and safety) standpoint, maximum throw is more crucial. The small throw of 60 deg is attainable in normal, one-handed operation without undue physical effort.

A wheel throw of 110 deg for completely mechanical systems has been specified in deference to the design problem posed by such systems.

As data from NASA-CR-635 indicate (figure 192), to maintain a desirable roll response sensitivity in terms of roll performance per degree of wheel deflection, the smaller the wheel throw, the lower the required roll Ask performance. (This is valid providing roll effectiveness is equal to or greater than the specified roll effectiveness requirements.)

NATO Rpt 508A makes recommendations concerning the amount of wheel throw for one-handed operation. Although the comments pertain to VTOL vehicles, the recommendation may well be of general applicability. The NATO Rpt 508A recommendation is that for one-handed operation the wheel throw should not exceed 60 deg in each direction.

REQUIREMENT LESSONS LEARNED

Pilots have been critical of the larger wheel throws which were prevalent in the past, before the advent of powered controls.

The F-15 has an aileron-rudder interconnect and reduced differential tail/aileron authority for roll performance at high angle of attack. However, ability to use full lateral control stick with large aft stick displacement was limited by interference with the pilot's legs. Therefore, the lateral control system was mechanized such that partial lateral stick deflection provides full rudder and lateral control deflection with large aft stick deflections. (The reduced lateral control surface deflection and the aileron-rudder interconnect prevent roll reversal at high angle of attack.)

5.5.9.1 Wheel control displacements -verification.

Verification shall be by inspection or flight test

VERIFICATION RATIONALE (5.5.9.1)

Normally full wheel or stick throw will meet this requirement. If the roll performance requirements can be met with less than full wheel or stick throw, flight tests will show the throw actually required.

MIL-STD-1797A
APPENDIX A

VERIFICATION GUIDANCE

Stops are normally provided at the column to limit wheel travel.

VERIFICATION LESSONS LEARNED

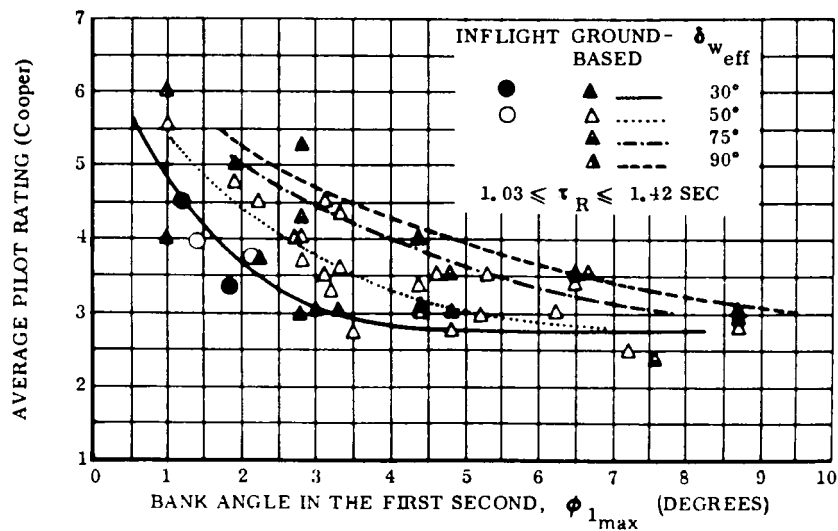

FIGURE 192. Variation of pilot rating with bank angle in the first second for four values of effective angle (from (NASA-CR-635))

MIL-STD-1797A
APPENDIX A

4.5.9.2 Roll axis control forces to achieve required roll performance.

The roll control force required to obtain the rolling performance specified in 4.5.8.1 shall be neither greater than _____ nor less than _____.

REQUIREMENT RATIONALE (4.5.9.2)

Pilot force capabilities must be observed and over sensitivity must be avoided.

REQUIREMENT GUIDANCE

The related MIL-F-8785C requirement is paragraph 3.3.4.3.

TABLE XXXVI. Recommended maximum roll control force.

LEVEL	CLASS	FLIGHT PHASE CATEGORY	MAXIMUM FORCE (pounds)		
			CENTERSTICK	WHEEL	SIDESTICK*
1	I, II-C, IV	A, B	20	40	
		C	20	20	
	II-L, III	A, B	25	50	
		C	25	25	
2	I, II-C, IV	A, B	30	60	
		C	20	20	
	II-L, III	A, B	30	60	
		C	30	30	
3	All	All	35	70	

*No forces are recommended for sidestick controllers at this time. However, forces should not be so large or so small as to be objectionable to the pilot.

Recommended minimum roll control force for all controllers is the sum of the breakout force plus:

Level 1: One-fourth of the Level 1 values in table XXXVI

Level 2: One-eighth of the Level 2 values in table XXXVI

Level 3: Zero

For two-handed operation, the force limits apply to the sum of right- and left-hand forces.

In combination with the roll control power requirements of 4.5.8.1, this paragraph specifies control force gradients for good flying qualities. The maximum and minimum forces are unchanged from MIL-F-8785C.

REQUIREMENT LESSONS LEARNED

MIL-STD-1797A
APPENDIX A

5.5.9.2 Roll axis control forces to achieve required roll performance-verification.

Verification shall be by analysis, simulation, and flight test.

VERIFICATION RATIONALE (5.5.9.2)

Control forces should be found while verifying compliance with 4.5.8.1.

VERIFICATION GUIDANCE

See 5.5.8.1. Unpowered control systems hinge moments, which vary as dynamic pressure, are an additional consideration. For aircraft with centerstick controllers, 4.5.9.3 should be applied along with this requirement.

VERIFICATION LESSONS LEARNED

MIL-STD-1797A
APPENDIX A

4.5.9.3 Roll axis control sensitivity.

The roll control force gradient shall have the following characteristics: _____. In case of conflict between the requirements of 4.5.9.3 and 4.5.9.2. the requirements of 4.5.9.3 shall govern.

REQUIREMENT RATIONALE(4.5.9.3)

For all aircraft, control sensitivity is an important flying qualities factor. Over-sensitivity can cause pilot-induced oscillations. The gradient as well as the maximum force (4.5.9.2) is important. This gradient requirement will tend to be more critical for Class IV aircraft, in Category A Flight Phases.

REQUIREMENT GUIDANCE

The related MIL-F-8785C requirement is paragraph 3.3.4.1.3.

Recommended values are given in table XXXVII.

TABLE XXXVII. Recommended maximum roll control sensitivity for stick - controlled aircraft.

LEVEL	FLIGHT PHASE CATEGORY	MAXIMUM SENSITIVITY (deg in 1 sec)/lb
1	A	15.0
	C	7.5
2	A	25.0
	C	12.5

Although over-sensitivity has also been encountered in wheel-control aircraft, data are insufficient to recommend a quantitative requirement.

The roll power requirements of 4.5.8.1, in combination with the roll forces of 4.5.9.2, effectively specify roll control sensitivity except for aircraft with stick shaping networks such as discussed below. This paragraph is intended to place an absolute, firm upper limit on gradients to prevent excessive sensitivity, which can easily result in a roll PIO. Over-sensitivity has also been encountered on wheel-control aircraft.

Effects of nonlinear force-deflection characteristics should be considered for this requirement, e.g.: it is possible to design a control system which easily meets the limits specified for large inputs, but which still produces unacceptably high local sensitivity for small inputs. Nonlinear stick shaping, stick filters, and minimizing the lateral augmentor gains can circumvent this problem. The following discussion relates to Class IV aircraft.

1. Roll Command Augmentation System (CAS)

The elements of a command augmentation system (CAS)¹⁰ are shown in figure 193. In a roll rate CAS, filtered pilot control inputs are compared directly to actual roll response. CAS authority can be limited, with parallel direct links (e.g., the F-14, F-15, F-18, and B-1); or high command gains can be incorporated with full authority (e.g., the F-16). Examples of both types will be reviewed here.

¹⁰ In the past 'CAS' has also been referred to as control, rather than command, augmentation system. These terms are identical.

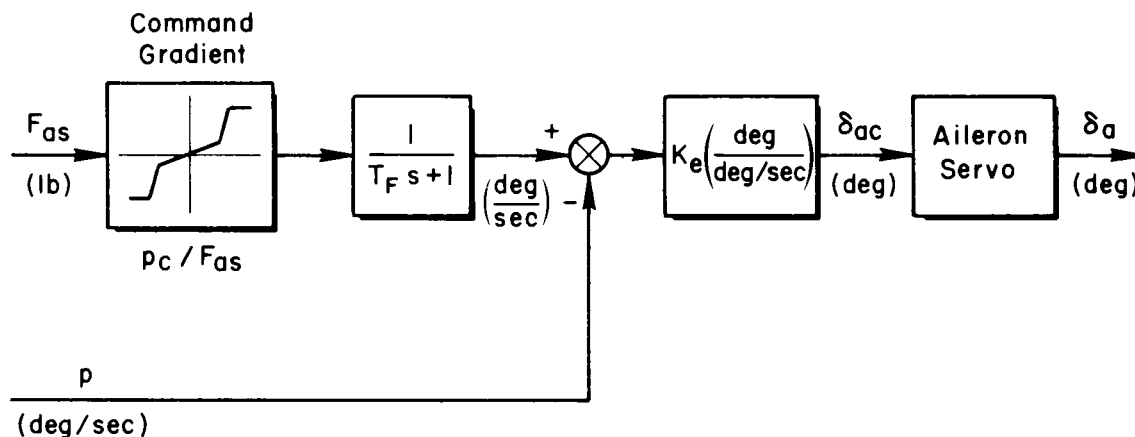

FIGURE 193. Block diagram representation of full-authority roll rate command augmentation systems.

From AFFTC-TR-73-32, AFFTC-TR-75-15, AFFTC-TR-79-10, AFFTC-TD-72-1, AFFTC-SD-69-5, and AFFTC-TR-76-15, with high-authority roll, CAS responses to command inputs are sharp and rapid; control precision can be excellent; in turbulence, hands-off operation is improved. However, some distinct problems have arisen as well: over sensitivity to small control inputs; over control with large inputs; pilot-induced oscillations; and the phenomenon known as roll ratcheting. Causes of and cures for these shortcomings will be discussed.

a. Gradient Shaping

A key element is the gradient between commanded roll rate and stick force, p_c/F_{as} (figure 193). High-gain, high-authority systems have had problems with extreme sensitivity for small inputs and inadequate roll performance with large inputs (AGARD-CP-319); saturation and small T_R contribute. A cure has been to decrease p_c/F_{as} for small inputs via a nonlinear stick shaping network, while allowing a high gradient for larger inputs. The resulting parabolic p_c/F_{as} shaping appears as shown on figure 194. Experience with a limited number of CASs has shown that command networks which fall within the range shown on figure 194 will have acceptable response properties, as long as the roll time constant and roll performance requirements and recommendations are satisfied.

Figure 194 also reflects the range of actual maximum roll rates (achieved) for these command networks. In general, for small inputs (on the order of 1/2 stick travel or less) the commanded roll rates were obtained, but larger force inputs generally did not produce the larger rates commanded; that is, the command was not held in long enough. Possible explanations are actuator rate limiting (which would increase the effective T_R), a relatively small desired bank-angle change and the pilot's inability to stop precisely at the desired bank angle.

In almost all high-performance or high-altitude augmented aircraft a yaw damper minimizes undesirable yawing motions while rolling. These effects on handling qualities and performance will be considered separately.

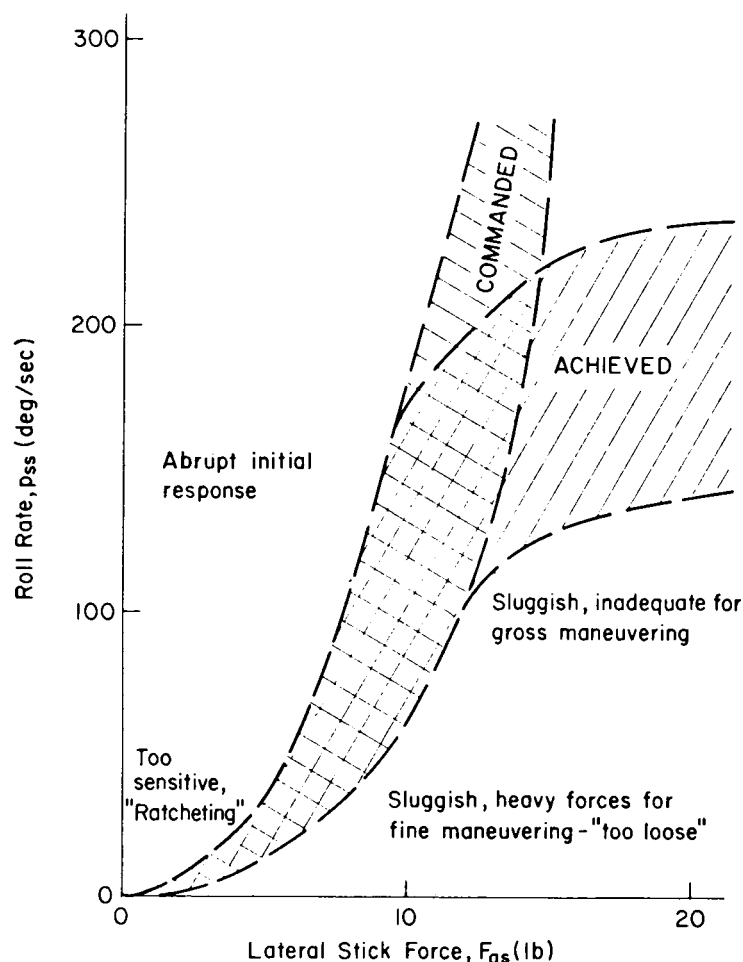

FIGURE 194. Range of acceptable nonlinear roll command shaping networks based on flight tests (Class IV aircraft, Flight Phase Category A, right roll).

b. Roll Responses for Conventional Aircraft

Fighter aircraft with conventional, fully powered hydraulic servos but without CAS (for instance, 1950s-generation fighters) generally have linear stick-to-surface linkages, i.e., S_a response to F_{as} is linear (above breakout). However, wind tunnel and flight tests of these aircraft show that aileron effectiveness is nonlinear with deflection; large deflections produce an incrementally larger rolling moment than do small deflections. The result is a parabolic force/response curve. As an example, figure 195 shows the p_{max}/F_{as} curves for three aircraft, taken from flight or wind tunnel/flight test results. Parabolic p_c/F_{as} networks, therefore, artificially supply to the pilot what some aircraft without CAS have naturally.

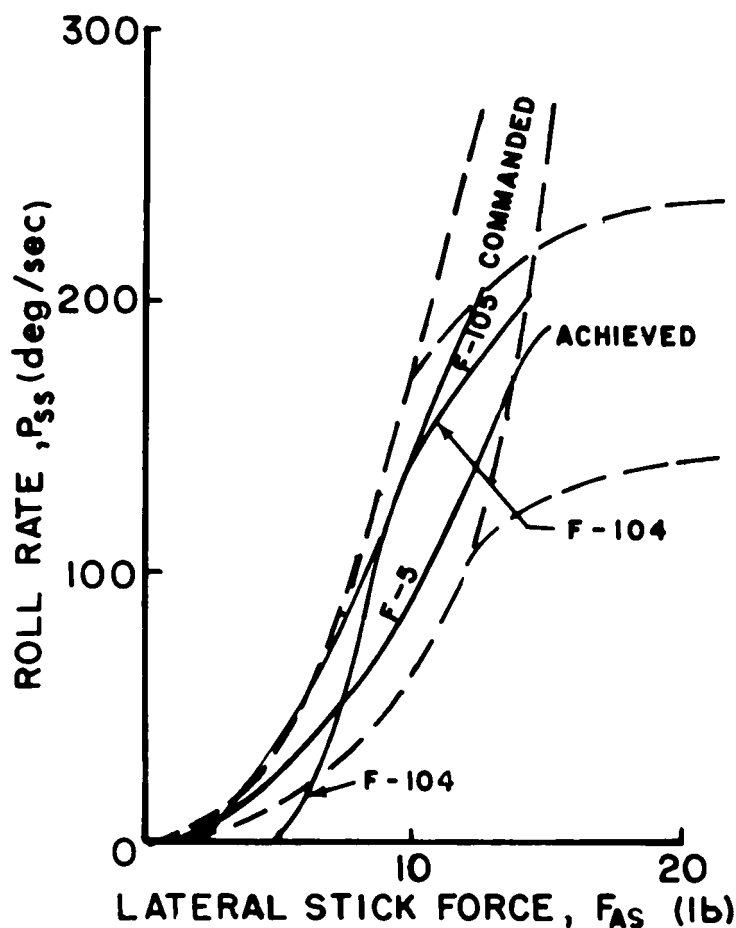

FIGURE 195. Comparison Of P_{max} @ F_{as} for several conventional Class IV aircraft with CAS curves of figure 194.

c. Roll CAS Gradients

Evolution of the F-16 CAS shaping network is a valuable lesson (figure 196). The unique characteristics of the near-isometric sidestick controller undoubtedly played a significant role. Simulations of the YF-16 (AFFTC-TR-75-15) prior to first flight produced a very steep p_c/F_{as} gradient with maximum stick forces of 4 lb. In-flight simulation of YF-16 takeoffs and landings in the USAF/Calspan variable-stability NT-33 resulted in a decrease in the initial gradient by a factor of two. During a high-speed taxi test, a divergent lateral pilot-induced oscillation (PIO) was encountered on the prototype YF-16 after the aircraft inadvertently became airborne (figure 197). The pilot, committed to fly, was then able to back off on his control gain, and the PIO stopped, after which a normal landing was made.

MIL-STD-1797A
APPENDIX A

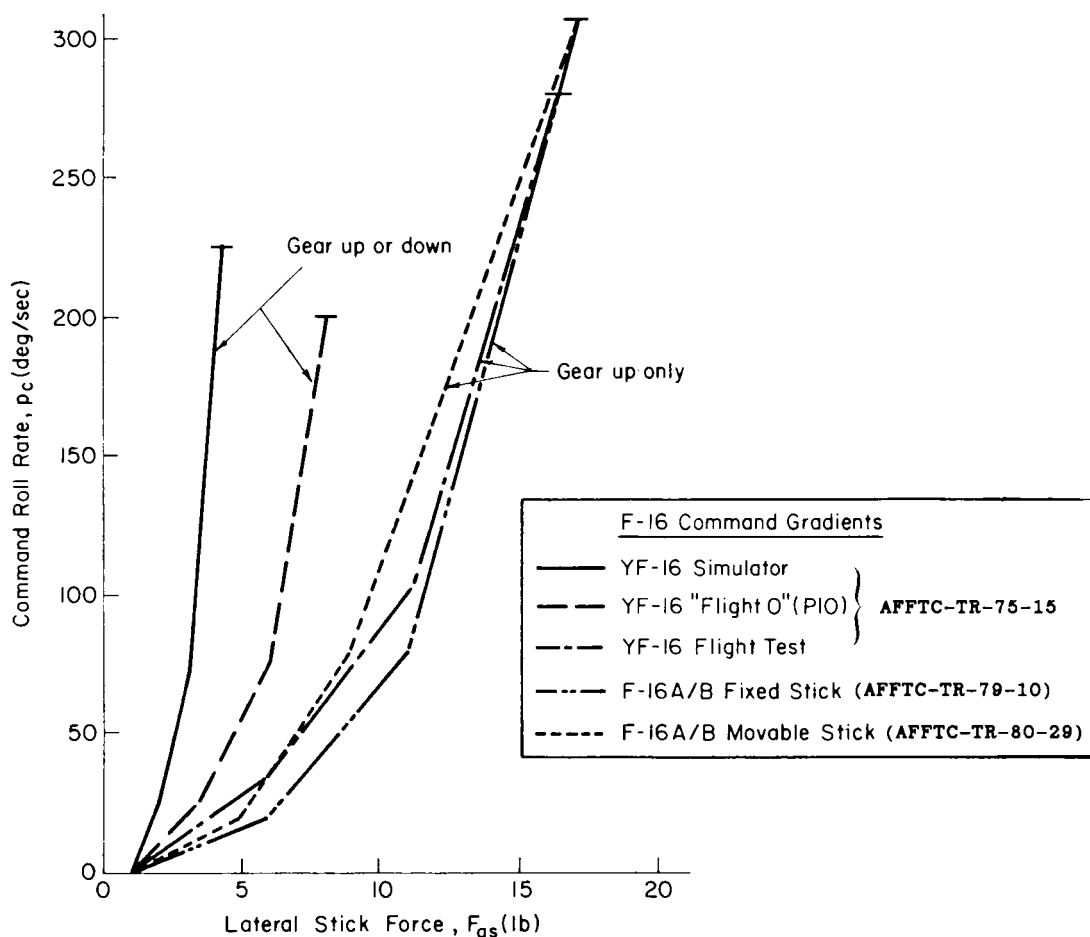

FIGURE 196. Evolution of the F-16 CAS shaping network.

This PIO was directly traceable to excessive stick sensitivity around zero, and after the flight (dubbed "Flight 0") the stick sensitivity was reduced further and the PIO tendency disappeared. The final F-16A/B (fixed-stick) (AFFTC-TR-79-10) gradient was reduced even more. With the latest F-16 variable roll prefilter (AFFTC-TR-80-29), it has been possible to increase the CAS gradient somewhat.

F-16 roll performance is discussed under 4.5.9.1. The final YF-16 command gradient of AFFTC-TR-75-15 (figure 196) produced acceptable response for small, precision stick inputs, though pilot comments indicate that excessive sensitivity "when encountered, was usually related to the small-amplitude, high-frequency inputs associated with the closed-loop, high-gain tasks of formation, refueling, tracking, and landing."

Hence the nonlinear stick shaping and roll damping were reasonably successful in achieving acceptable maximum rolling performance without excessively compromising the small-amplitude precision tracking characteristics.

MIL-STD-1797A
APPENDIX A

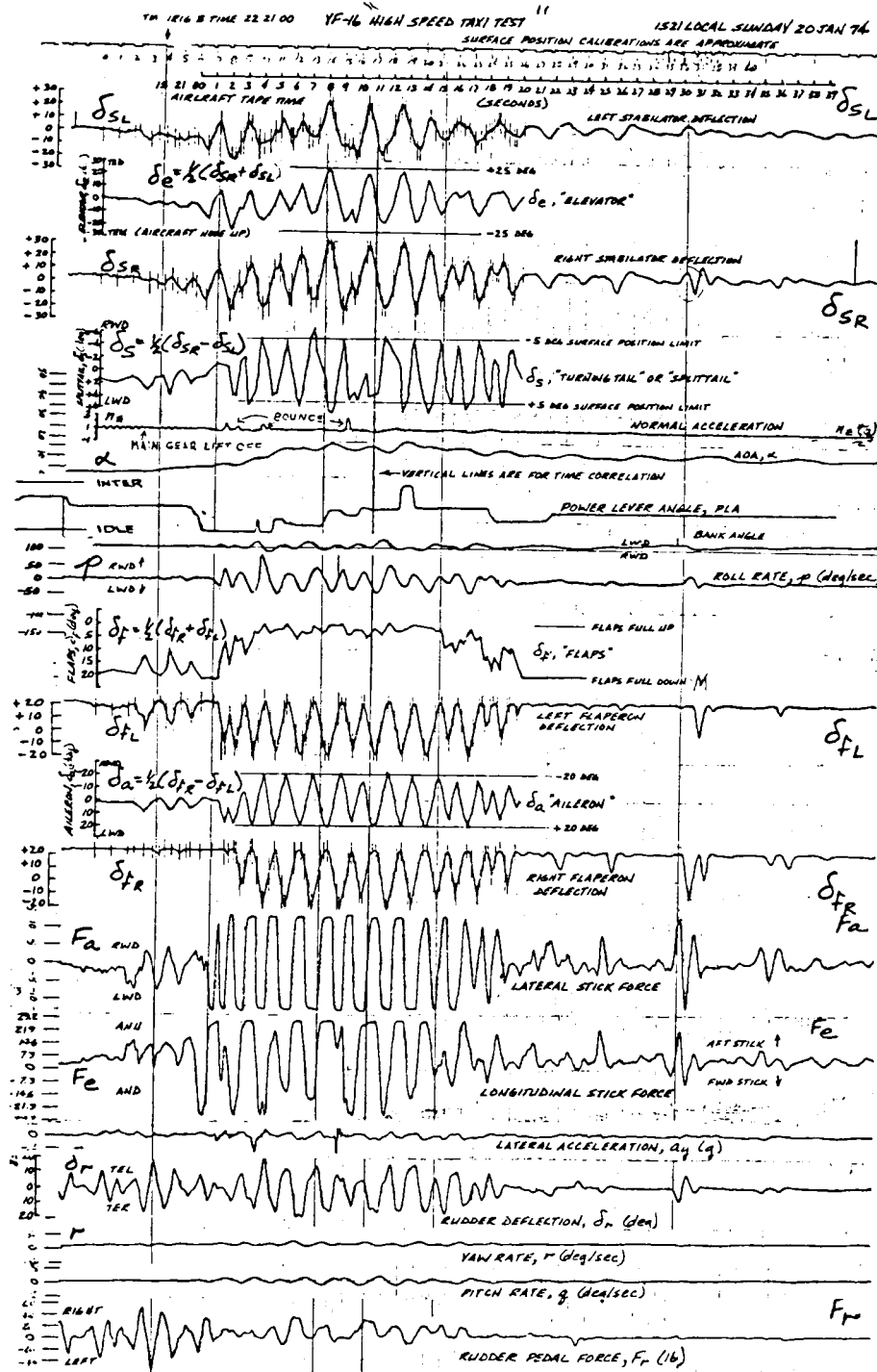

FIGURE 197. YF-16 PIO due to excessive lateral stick sensitivity (from AFFTC-TR-75-15).

MIL-STD-1797A
APPENDIX A

d. Roll Ratcheting

Roll ratcheting has been reported on most CAS-equipped aircraft, including the F-4 SFCS (AFFTC-TR-73-32), YF-16 (AFFTC-TR-75-15), F-16 (AFFTC-TR-79-10), and A-7D DIGITAC (AFFTC-TR-76-15). It was also experienced during the Calspan Lateral High-Order System (LATHOS) program of AFWAL-TR-81-3171. All of these cases will be discussed in detail in the following paragraphs.

An example of DIGITAC roll ratcheting (AFFTC-TR-76-15) shown on figure 198 was encountered during a series of bank-to-bank maneuvers: a limit cycle at a frequency of about 18 rad/sec. The roll CAS is presented in figure 199; p c/F as was Curve 1 in figure 199, indicating that stick shaping is not a cure for this problem: the stick sensitivity is reduced only around zero, allowing ratcheting to occur when the lateral stick force is non-zero, as in figure 198. Figure 199 and table XXXVIII document several of the CAS networks flown on the DIGITAC in developing an optimum CAS. This is an excellent review, since several gradients, prefilter lags, and error gains were evaluated.

As table XXXVIII reflects, CAS 2 with only a reduction by one-half in K_e eliminated the roll sensitivity. However, with the sensitivity reduced, the pilots then noted that the steady-state roll response was much too low (Halving K_e only reduced the steady-state response about 14%). With $K_e = 1.0$ and the prefilter lag time constant increased from 1/10 to 1/3 sec (CAS 3), the roll sensitivity was reduced, although not enough. It was clear from CASs 1-3 that: a) the roll response for large inputs was too low; b) an increase in the prefilter lag helped reduce sharp inputs; c) a reduction in the error gain eliminated ratcheting. Therefore, CAS 4 was evaluated. This involved a new p_c/F_{as} gradient (figure 199), including a 0.75 lb breakout, and lower T_F and K_e (table XXXVIII). It also produced a mild PIO tendency during air-to-air tracking, probably due to the breakout. Finally, a slightly more sensitive gradient with no breakout (Curve 5) was found to be best for all-around response.

TABLE XXXVIII. Descriptions of YA-7D digital CAS networks.

CAS*	ERROR GAIN K_e^* (deg/deg/sec)	PREFILTER LAG $1/T_F$ (rad/sec)	TYPICAL PILOT COMMENTS
1	1.0	10	Much too sensitive to sharp inputs (PR = 7); ratcheting (see figure 200)
2	0.5	10	Eliminated high sensitivity; steady-state response too low
3	1.0	3	Filter reduced sharp inputs, although not enough (PR = 7)
4	0.375	3	Lateral PIO tendency in fine tracking (incl. 0.75 lb breakout)
5	0.375	3	Best all-around response

* - See figure 199.

MIL-STD-1797A
APPENDIX A

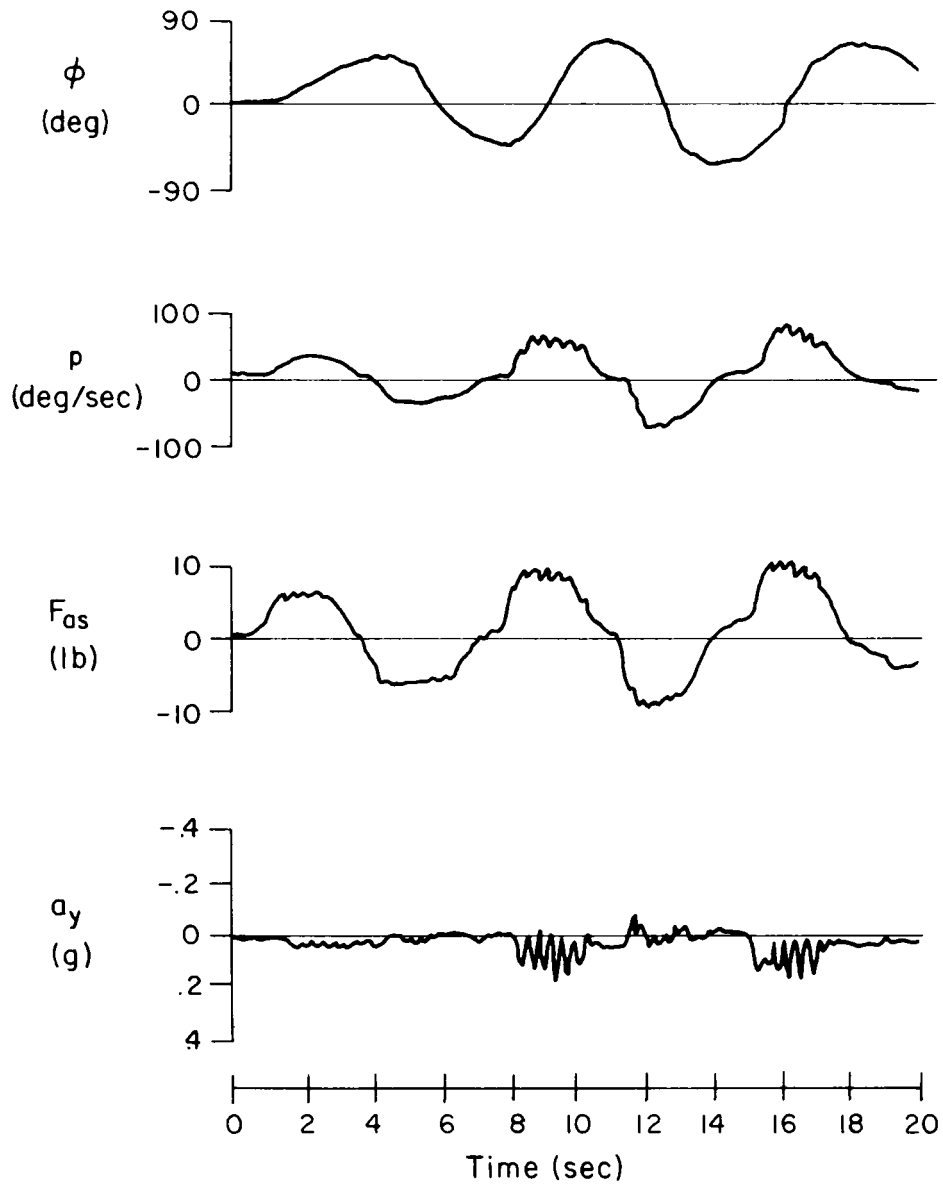

FIGURE 198. Roll ratchet during banking maneuvers (DIGITAC, AFFTC-TR-76-15) $h = 20,000$ ft, $M = 0.75$.

MIL-STD-1797A
APPENDIX A

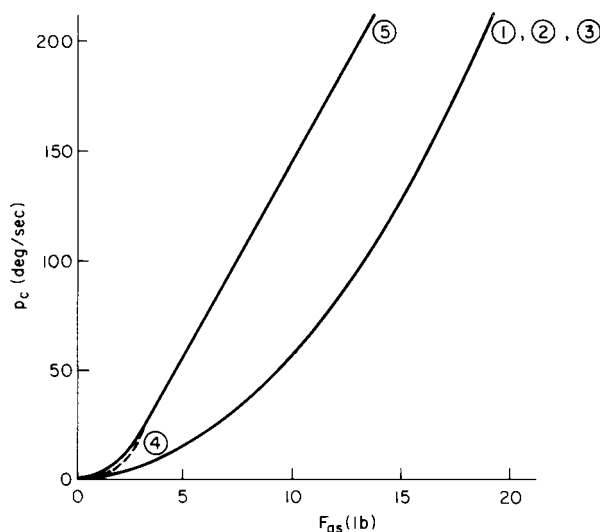
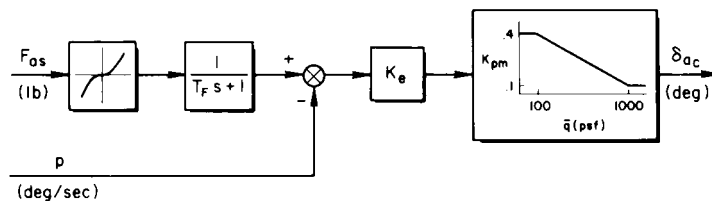

FIGURE 199. Evolution of roll CAS network for YA-7D DIGITAC (AFFTC-TR-76-15).

Another example of roll ratcheting, experienced on the YF-16 (AFFTC-TR-75-15), is given in figure 200. The pilot was attempting a steady roll with less than full control input. The ratcheting is seen to be a lightly damped oscillation at a frequency of about 12 rad/sec. But in the second, later roll on figure 200, the pilot was able to perform a roll without encountering ratcheting: "Full-authority rolls did not involve the oscillation."

The roll ratcheting experienced on the YF-4E SFCS (AFFTC-TR-73-32) was of a somewhat different character, as it occurred primarily during fine maneuvering rather than during large-input rolls. A representative time history is not available, but AFFTC-TR-73-32 describes "an oversensitive roll response which was universally objectionable to the pilots. It tended to manifest itself in uncomfortably high roll accelerations during rolling maneuvering and roll 'ratcheting' or jerkiness around neutral, particularly during tasks involving precise control." One pilot commented that the ratcheting 'becomes less noticeable during up and away flight. However, this problem is definitely noticeable while performing a close task such as formation or air to air tracking."

The final example occurred during flight evaluations on the USAF/Calspan variable-stability NT-33. An investigation of lateral flying qualities of highly augmented fighter aircraft (dubbed LATHOS for Lateral High-Order System, AFWAL-TR-81-3171) represents an excellent data base for detailed discussion on many of the handling quality concerns for modern aircraft.

MIL-STD-1797A
APPENDIX A

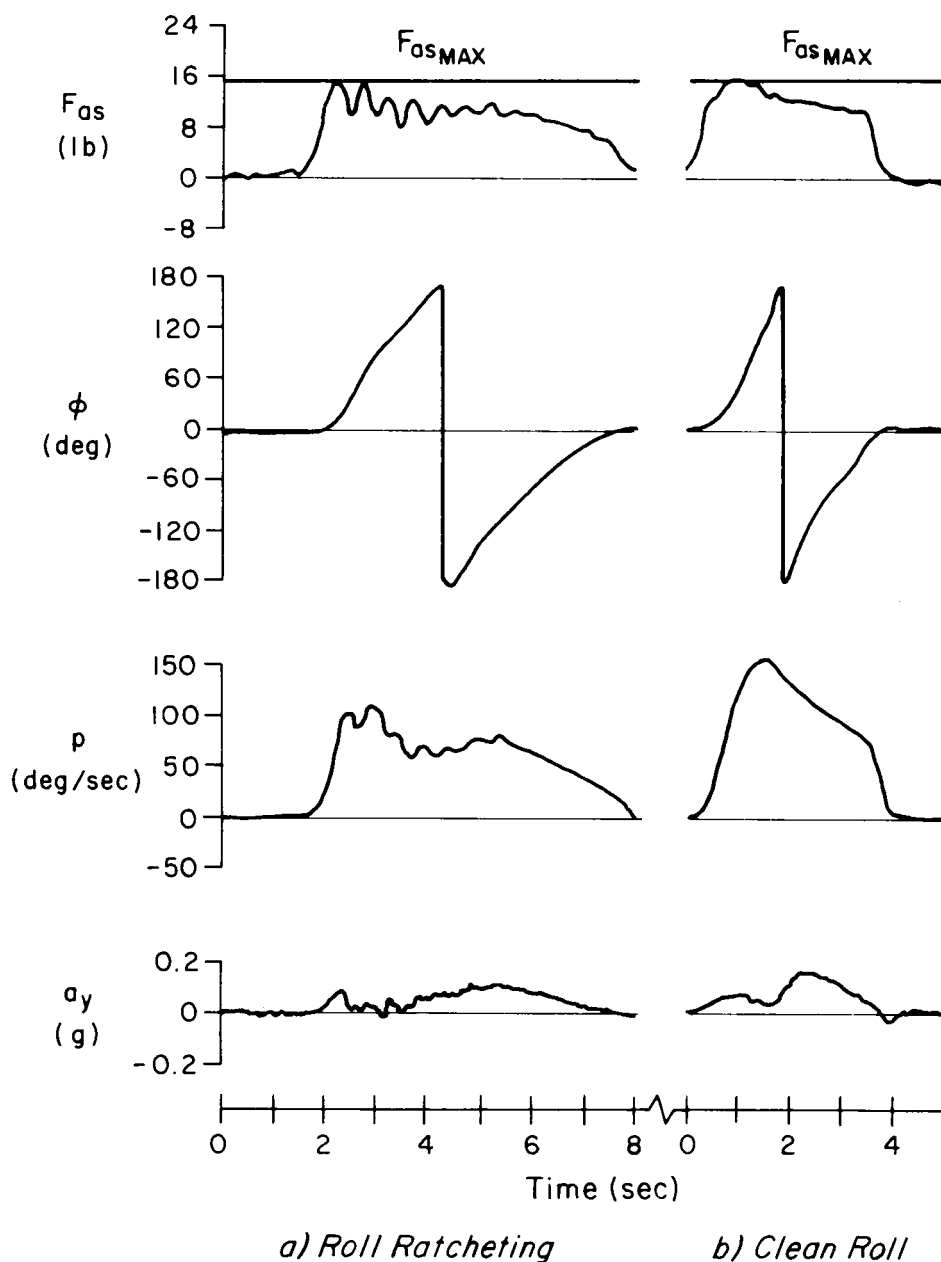

FIGURE 200. Steady rolls on YF-16 (AFFTC-TR-75-15). The roll in (b) was performed 32 seconds after (a) and was satisfactory. $h = 10,000$ ft, $M = 0.80$.

Mechanization of the lateral control was such that it may be considered a CAS. That is, the NT-33 variable-stability system was set up to command a certain ratio of steady-state roll rate to stick force (p_{ss}/F_{as}) with a certain time constant (T_R). Additionally, the spiral and dutch roll modes were suppressed for roll commands ($T_S \doteq \infty$ and $\omega_\phi/\omega_d \doteq 1$). Thus, with a variable prefilter and a time delay to account for actuator lags,

MIL-STD-1797A
APPENDIX A

$$\frac{p}{F_{ss}} \doteq \frac{T_F L'_{F_{as}} e^{-0.28s}}{(s + 1/T_F)(s + 1/T_R)}$$

Ratcheting was noted some times but not others, for T_R values of 0.45 second or less, more often at the higher sensitivities. Figure 201 illustrates the ratcheting from a HUD tracking task. (The very high frequency oscillations at 50-60 rad/sec are aileron buzz, resulting from an instability in the NT-33 variable-stability system with certain high command or feedback gains. In some instances the pilots complained about the buzz. This buzz was noted, when present, in the pilot comment summaries; where it may have influenced pilot ratings that evaluation was discounted.) The ratcheting is best seen in the p and F_{as} traces, at a frequency of about 16 rad/sec.

Figure 202 compares the p_{ss}/F_{as} gradients flown on LATHOS in Category A tasks (air-to-air tracking, HUD tracking, and aerial refueling) with the acceptable range from figure 194. Zero breakout or friction forces were mechanized. Several values of prefilter lag, T_F , were used with Configurations 5-2 and 5-3. Figure 203 shows the influence of T_F on pilot ratings.

For Configuration 5-2 ($p_{ss}/F_{as} = 10$), the roll response for small inputs lies well above the acceptable range on figure 202, while the response for large inputs falls below the range of acceptable gradients. The pilot comments for Configuration 5-2 are consistent with this observation. Typical comments were: "Took off pretty smartly initially, but felt heavy for final response ... Not predictable for fine tasks ... Quick, sharp, ratcheting." Pilot ratings for this case were Level 3 (PR = 7,6,7). These ratings and comments were for $T_F = 0.025$ sec. However, increasing T_F did little to improve the ratings (see figure 203) because of the inadequate response. Pilot comments reflect this: "Gross acquisition sluggish...Sensitivity low ... Took a lot of force."

For Configuration 5-3 ($p_{ss}/F_{as} = 18$, figure 202) the final response is improved, but the small-control-input response is much too sensitive. Pilot comments for the 40 rad/sec filter case ($T_F = 0.025$, figure 203) reflect this: "Gross acquisition -- no problem. Fine tracking was characterized by jerkiness ...Had the perception that the stick was moving in my hand." Prefilters of 3.33-10 rad/sec ($T_F = 0.3$ and 0.10 , figure 203) produced Level 1 pilot ratings, a trend like that found on DIGITAC. With $T_F = 1.0$, however, a PR of 7 was given; this was "Smooth but sluggish ...Wouldn't respond to aggressive inputs "

We note that the LATHOS configurations prone to roll ratcheting were: all of those with $L_{F_{as}} > 50$ (deg/sec²/lb, plus one observation of "slight ratcheting" for $L_{F_{as}} = 40$ and one "beginning" at $L_{F_{as}} = 30$, $T_R = 0.2$. Ratcheting occurred with T_R as long as 0.45 second. (As can be seen in figure 145, the minimum $L_{F_{as}}$ evaluated increased as T_R decreased.)

Finally, two nonlinear gradients (5-3N2 and 5-3N3, figure 202) had the effect of reducing the sensitivity for small inputs while still providing good power for large inputs. For 5-3N2, a pilot rating of 4-1/2 was given due to "Beginning of ratcheting -- not strong ... Jerky even with small inputs." For 5-3N3, a PR of 4 was similarly given because "initial response [was] too abrupt.... Adequate final roll rate for large inputs."

MIL-STD-1797A
APPENDIX A

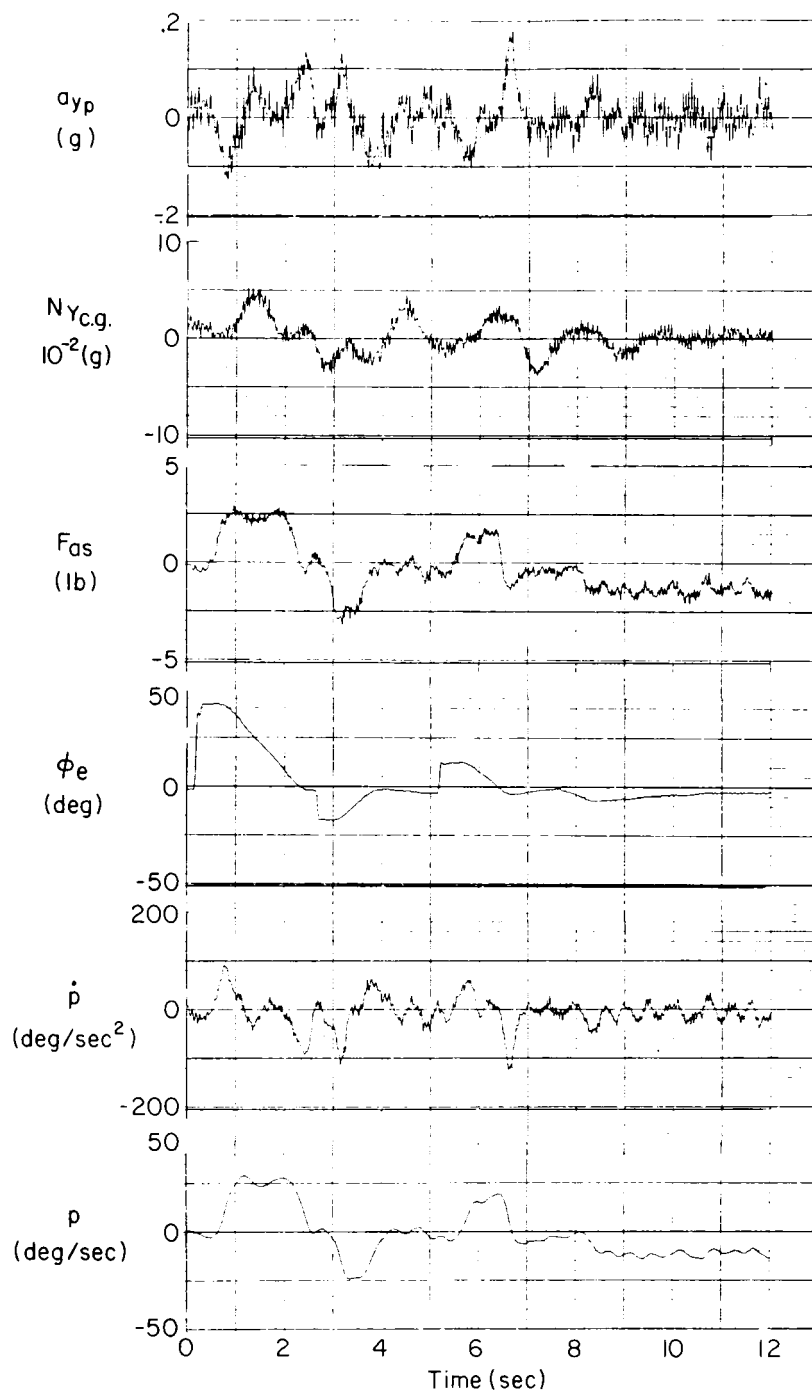

**FIGURE 201. Roll ratcheting experienced on LATHOS (AFWAL-TR-81-3171)
Configuration 5-2.**

MIL-STD-1797A
APPENDIX A

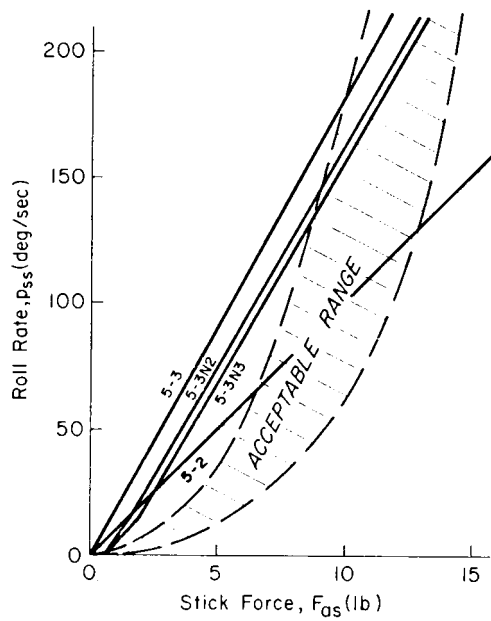

FIGURE 202. Roll gradients for LATHOS configurations 5-2 and 5-3 ($T_R = 0.15$ sec) compared with acceptable range from figure 194.

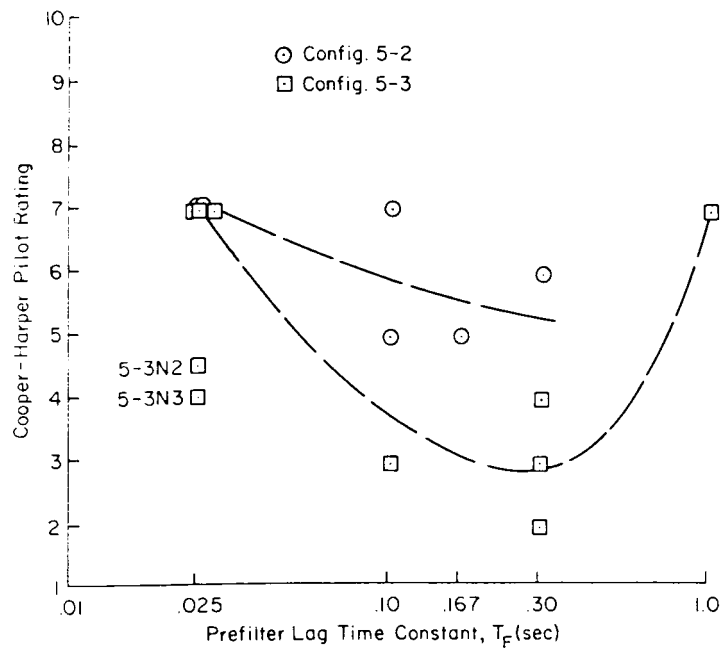

FIGURE 203. Influence of prefilter lag on pilot ratings (AFWAL-TR-81-3171).
 $T_R = 0.15$ sec.

MIL-STD-1797A
APPENDIX A

The LATHOS results are very similar to those for DIGITAC, i.e., ratcheting was reduced by addition of a roll prefilter around 3 rad/sec. However, as discussed in 4.2.1.2. stick prefilters are a major contributor to overall effective time delay, τ_e . For example, figure 18a shows that a 3 rad/sec. prefilter contributes about 0.1 second to the overall time delay in the longitudinal axis. For sophisticated aircraft control systems, with structural filters, sensor filters, etc. included, a prefilter as low as 3 rad/sec. could cause an unacceptably large delay. The prefilter thus should not be looked on as a final solution.

Yet another source of over sensitivity is noted in AGARD-CP-319, as illustrated in figure 204. A current design trend is to use high-gain forward-loop stabilization for robust, fast, stable response, with a prefilter to shape the response to pilot commands as desired. The high gain tends to saturate the actuators, etc. far short of maximum command. When the sensitivity is adjusted for large commands, then, in Navy experience the system can be grossly over sensitive for small inputs.

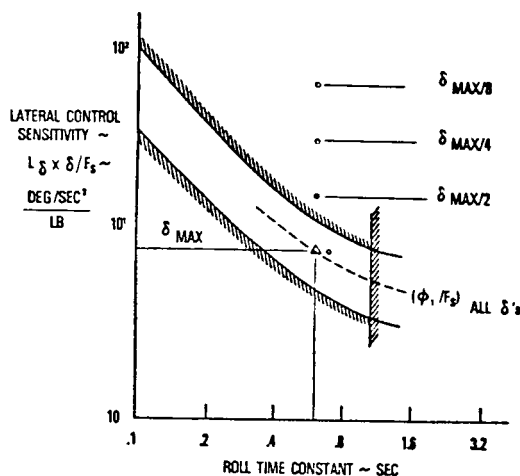

FIGURE 204. Typical roll sensitivity - high gain.

e. Guidance for Acceptable Sensitivity

The following guidelines are offered to obtain adequate roll control power for large control inputs:

Avoid excessive time delay, which is a source of lateral PIO tendencies. Stick filters will eliminate roll ratcheting. However, the break frequency should be carefully evaluated in terms of time delay (see figure 168).

Utilize nonlinear stick shaping in the region specified in figure 194.

Avoid control saturation and excessively large values of $1/T_R$ by minimizing the gain on the roll rate feedback. Figure 145 suggests $1/T_R < 4$.

As a rule of thumb, use no more than half the optimum sensitivity determined in a ground-based simulation (AGARD-C-333).

2. Supporting Data

a. Program of AFFDL-TR-67-98 (Flight Phase Category A)

In this in-flight lateral-directional flying qualities program for a typical fighter mission the pilots were allowed to select the sensitivity of the aileron control. (The spring rate was $F_{as}/\delta_{as} = 3.81 \text{ lb/in.}$). Only the

MIL-STD-1797A
APPENDIX A

resulting optimum sensitivities are shown on figure 205 because most configurations were Level 2 or worse in dutch roll or roll mode characteristics. Many of the points are associated with poor pilot ratings. Hence there is a tacit assumption that the optimum roll sensitivity is the same for Level 1 and 2 values of ω_d and ζ_d .

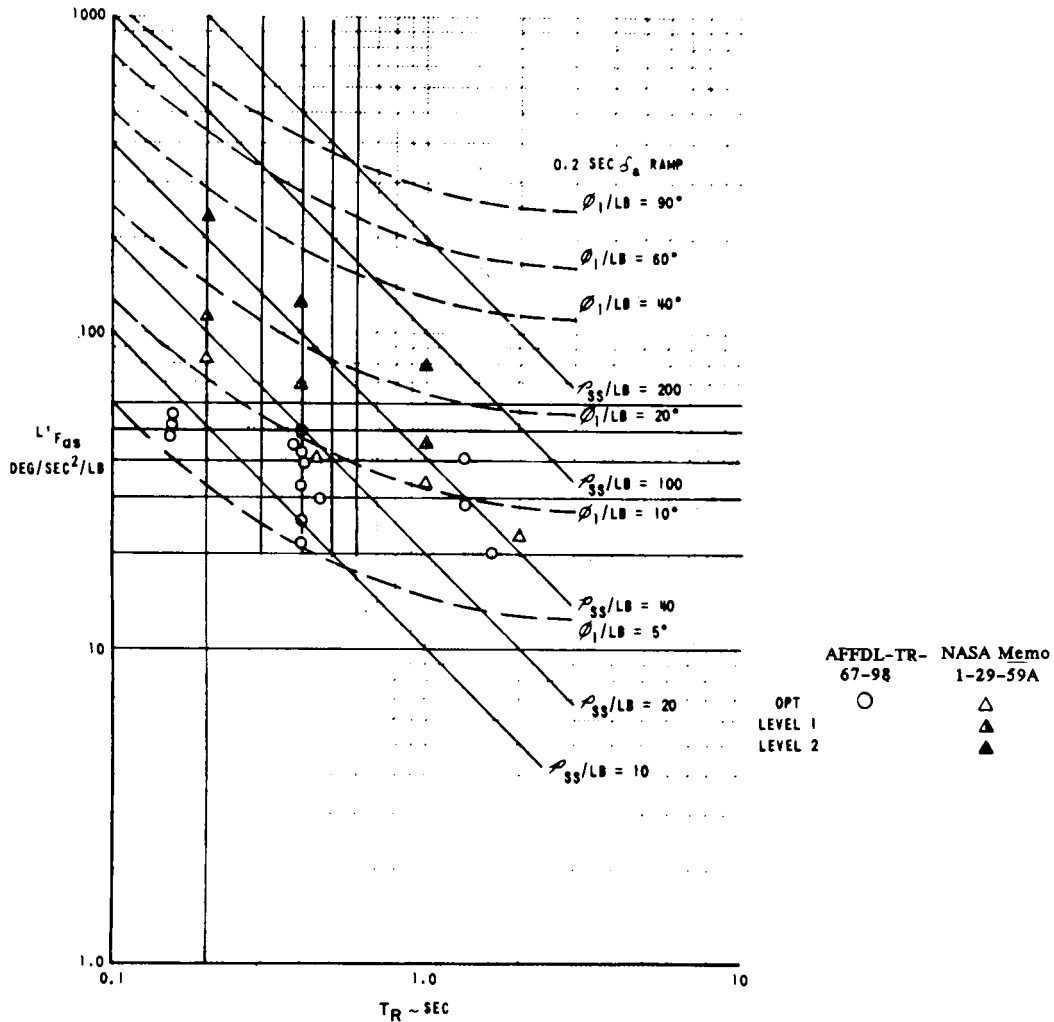

FIGURE 205. Flight Phase Category A - force sensitivity.

b. Program of NASA Memo 1-29-59A (Flight Phase Category A)

In this program, which utilized a rolling simulator and several fighter aircraft, a parametric variation of $L_{\delta_a} \delta_{a_{max}}$ and T_R was made to determine lateral control requirements for fighter aircraft performing fighter missions. The results, then, should be directly comparable to those of AFFDL-TR-67-98. The NASA Memo 1-29-59A data are plotted along with the AFFDL-TR-67-98 data on figure 205. Optimum values and the values corresponding to Level 1 and Level 2 flying qualities are also shown. The spring rate, F_{as}/δ_{as} , was 2 lb/in.

It can be seen from figure 205 that the data points of constant pilot rating lie approximately along lines of constant 40, (bank angle in one second). This suggests that, at least for Class IV aircraft performing fighter missions, roll response sensitivity can be best expressed in terms of ϕ_1/F_{as} (bank angle in 1 second

MIL-STD-1797A
APPENDIX A

per pound). It can further be seen that the data points from NASA Memo 1-29-59A for Level 1 roll response sensitivity be along a curve of $\phi_i/F_{as} = 15$ deg/lb; for Level 2 flying qualities, $\phi_i/F_{as} = 25$ deg/lb. Both sets of data indicate that for optimum roll response sensitivity $401/F_{as}$ should be between 10 and 20 deg/lb. A possible exception is indicated by the low- T_R data of AFFDL-TR-67-98, where the pilots selected somewhat lower optimum roll response sensitivities.

Figure 206 shows actual data from the tests of NASA Memo 1-29-59A. The pilot ratings from the moving-base simulation (figure 206b) clearly support the gradient limits of table XXXVII. Differences between the fixed and rolling simulator results are presumably due to the additional accelerations the pilots sensed in the rolling simulator. These results indicate that evaluations of roll sensitivity should involve a moving-base simulator as a minimum.

c. Program of Princeton Univ Rpt 727 (Flight Phase Category C)

In order to compare the fighter-aircraft data for up-and-away flight with data for the landing approach, consider the in-flight data of Princeton Univ Rpt 727 shown on figure 207. From comparisons of figures 205 and 207 it can be seen that the optimum roll response sensitivity, maximum satisfactory roll response sensitivity (Level 1), and maximum acceptable roll response sensitivity (Level 2), in terms of rolling acceleration per force for the landing approach, are about half those for the respective Levels of flying qualities for Flight Phase Category A. This proportion is reflected in table XXXVII.

REQUIREMENT LESSONS LEARNED

The F-5 roll gradients in both Category A and C flight fall well within the Level 1 limits (AFFDL-TR-71-134). Similarly, flight test data from Navy Rpt No. SA-14R-81 show that gradients for the original F-18A in Category A and C flight phases are within the Level 1 limits.

As discussed in "Guidance for Application," aircraft with high-gain, high authority roll augmentation systems require a parabolic stick shaping network. Such a network makes it possible to maintain the required sensitivity for small stick deflections without giving up rolling performance for large stick deflections. The F-18 has a parabolic stick shaping network and the data quoted represent sensitivities for small stick deflections such as used for precision tracking.

5.5.9.3 Roll axis control sensitivity-verification.

Verification shall be by analysis, simulation, and flight test.

VERIFICATION RATIONALE (5.5.9.3)

Verification will be in connection with buildups and demonstrations of roll performance (5.5.9.1), and evaluations in operational-type maneuvers involving precise tracking.

VERIFICATION GUIDANCE

Roll commands of all sizes need to be investigated for precise control tasks. Both minimum and maximum sensitivity are specified. The critical factors are enumerated and discussed in 4.5.9.3 guidance.

MIL-STD-1797A
APPENDIX A

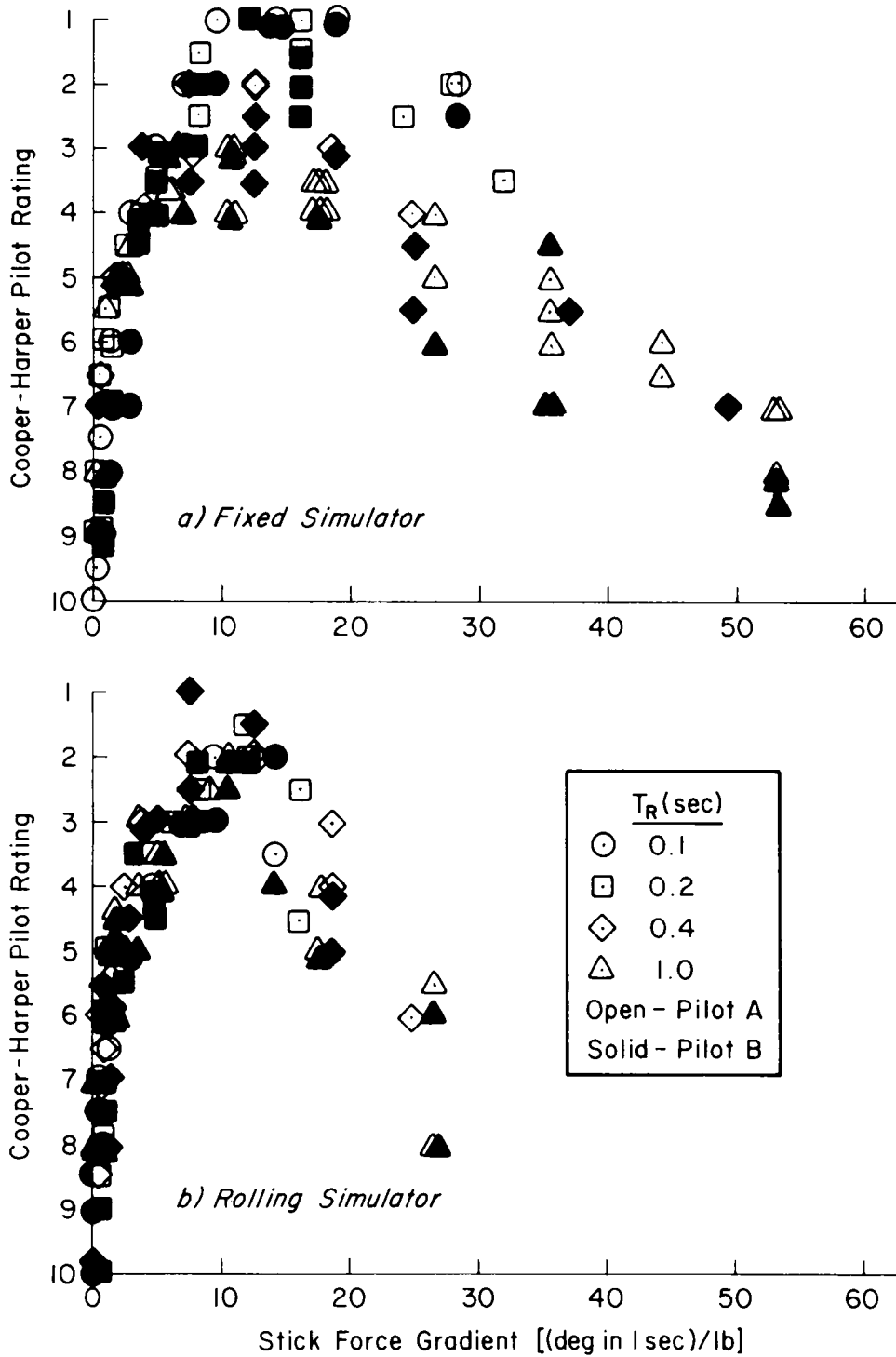

FIGURE 206. Pilot ratings from NASA Memo 1-29-59A (Category A Flight Phase).

MIL-STD-1797A
APPENDIX A

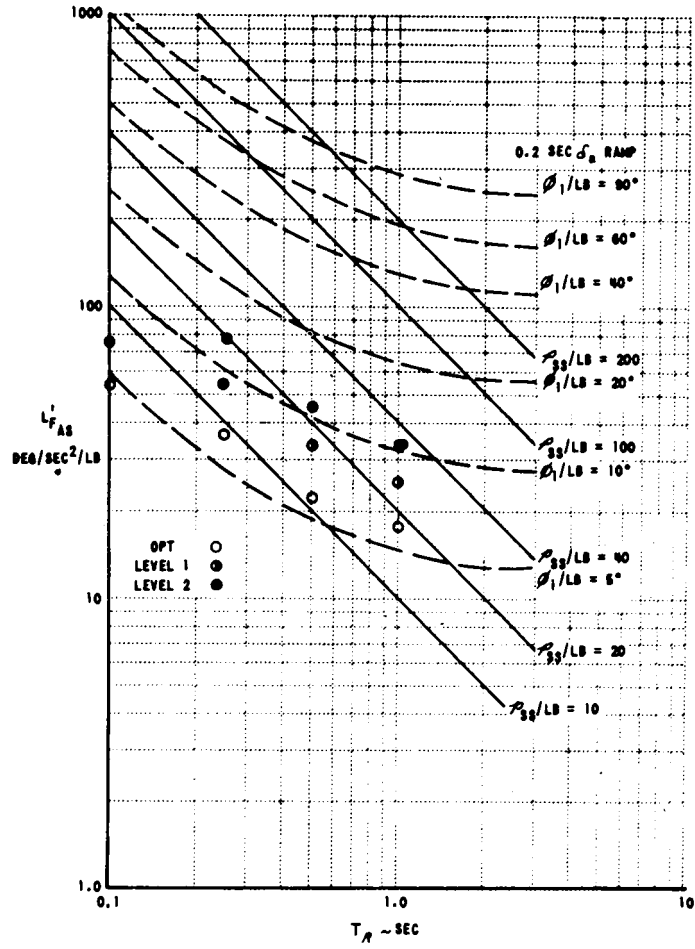

FIGURE 207. Flight Phase Category C - force sensitivity (from Princeton Univ Rpt 727).

VERIFICATION LESSONS LEARNED

MIL-STD-1797A
APPENDIX A

4.5.9.4 Roll axis control centering and breakout forces.

Breakout forces, including friction, preload, etc., shall be within the following limits:

REQUIREMENT RATIONALE(4.5.9.4)

Quantitative limits assure that centering and breakout characteristics of the roll controller will allow effective control without adding unduly to the pilot's workload.

REQUIREMENT GUIDANCE

The related MIL-F-8785C requirement is paragraph 3.5.2.1.

Recommended breakout force limits are given in table XXXIX.

TABLE XXXIX. Recommended allowable breakout forces (lb).

LEVEL	CONTROL	CLASSES I, II-C, IV		CLASSES II-L, III	
		MINIMUM	MAXIMUM	MINIMUM	MAXIMUM
1 and 2	Sidestick	1/2	1		
	Centerstick	1/2	2	1/2	4
	Wheel	1/2	3	1/2	6
3	Sidestick	1/2	4		
	Centerstick	1/2	4	1/2	8
	Wheel	1/2	6	1/2	12

4.1.12.1 has additional, qualitative requirements on control centering and breakout forces. The values in table XXXIX come from a combination of a long history (but unfortunately not well documented) of flight test and operational experience and variable-stability aircraft evaluations. The sidestick breakout forces in table XXXIX are based upon recommendations of AFFDL-TR-79-3126.

REQUIREMENT LESSONS LEARNED

5.5.9.4 Roll axis control centering and breakout forces-verification.

Verification shall be by analysis, simulation and flight test.

VERIFICATION RATIONALE(5.5.9.4)

Measurement of breakout forces on the ground will ordinarily suffice in lieu of actual flight measurement, provided that qualitative agreement between ground measurement and flight observation can be established.

VERIFICATION GUIDANCE

Verification must be performed on the actual flight article. Changes to the flight control system may make it necessary to check the production version as well as the flight test aircraft.

VERIFICATION LESSONS LEARNED

4.5.9.5 Roll axis control force limits

4.5.9.5.1 Roll axis control force limits in steady turns.

For Levels 1 and 2, with the aircraft trimmed for wings-level, straight flight it shall be possible to maintain steady turns in either direction with the yaw controls free at the following combinations of bank angle and roll controller force characteristics:

REQUIREMENT RATIONALE(4.5.9.5.1)

By limiting the amount of uncoordination, this requirement limits the pilot effort required to perform coordinated turns.

REQUIREMENT GUIDANCE

The related MIL-F-8785C requirement is paragraph 3.3.2.6.

Recommended values:

Aircraft Class	Bank Angle (deg)
I and II	45
III	30
IV	60

Maximum roll control forces:

Centerstick controller:	5 lb
Wheel controller:	10 lb

This requirement, in combination with 4.6.7.2, limits the allowable control forces in steady turns. The object is to insure that only modest steady roll control forces need be held when rudder pedals are not used, and consequently that excessive rudder pedal use is not needed for coordination. Retrimming is undesirable. Not only does that add to pilot workload, but the reference for straight flight is then lost.

The steepness of the turn is a function of aircraft Class, to correspond with normal operational use.

This requirement applies to Levels 1 and 2 only, since it is expected that Level 3 operations would not involve prolonged turns at large bank angles.

REQUIREMENT LESSONS LEARNED

5.5.9.5 Roll axis control force limits-verification

5.5.9.5.1 Roll axis control force limits in steady turns-verification.

Verification shall be by analysis, simulation and flight test.

MIL-STD-1797A
APPENDIX A

VERIFICATION RATIONALE(5.5.9.5.1)

Measurement is straightforward in either flight or simulator. Slipstream, engine gyroscopic or other asymmetries may make forces different to the right and to the left.

VERIFICATION GUIDANCE

Flight testing at the specified bank angle and corresponding normal load factor, at maximum operational altitude and minimum operational velocity, generally presents the most potential for large yawing moments and large effective dihedral.

For a steady turn about a vertical axis, from the y-force equation in stability axes,

$$\dot{\psi} = \frac{g}{V_T \cos \beta} \tan \Phi + \frac{n_y}{\cos \gamma \cos \Phi}$$

In a coordinated turn the ball is centered -- that is, n_y is zero. But for a roll-control-only, level turn it can be shown that, with all quantities in stability axes (i.e., $w = 0$) the steady roll control and sideslip are given approximately (for $\beta^2 \rightarrow 0$ and neglecting C_{y_r}) by

$$\begin{bmatrix} C_{\ell_\beta} + \frac{bg}{2V_T^2} C_{y_\beta} \left[\frac{C_{\ell_r}}{C_{L_1}} - 4 \left(k_z^2 - k_y^2 \frac{\bar{c}^2}{b^2} \right) \sin \Phi \tan \Phi \right] & C_{\ell_{\delta_a}} \\ C_{n_\beta} + \frac{bg}{2V_T^2} C_{y_\beta} \left[\frac{C_{n_r}}{C_{L_1}} - 4k_{xz}^2 \sin \Phi \tan \Phi \right] & C_{n_{\delta_a}} \end{bmatrix} \begin{bmatrix} \beta \\ \delta_a \end{bmatrix} = \frac{bg}{V_T^2} \begin{bmatrix} -\frac{1}{2} C_{\ell_r} \sin \Phi + C_{L_1} \left(k_z^2 - k_y^2 \frac{\bar{c}^2}{b^2} \right) \sin^2 \Phi \tan \Phi \\ -\frac{1}{2} C_{n_r} \sin \Phi + C_{L_1} k_{xz}^2 \sin^2 \Phi \tan \Phi \end{bmatrix}$$

where $C_{L_1} = W/(\bar{q} S)$, $k_y^2 = I_y/(m \bar{c}^2)$, $k_z^2 = I_z/(mb^2)$, $k_{xz}^2 = I_{xz}/(mb^2)$; $n_y = C_{y_\beta} \beta / C_{L_1}$.

Roll control deflection is seen to depend on spiral stability (through $C_{n_\beta} C_{\ell_r} - C_{\ell_\beta} C_{n_r}$) and nonlinear inertial terms involving bank angle or, equivalently, turn rate. For the roll and yaw control in coordinated turns see the discussion of 4.6.7.2.

VERIFICATION LESSONS LEARNED

MIL-STD-1797A
APPENDIX A

4.5.9.5.2 Roll axis control force limits in dives and pullouts.

Roll control forces shall not exceed _____ lb in dives and pullouts to the maximum speeds specified in the Service Flight Envelope.

REQUIREMENT RATIONALE(4.5.9.5.2)

Excessive roll control forces in intended symmetric dives and pullouts increase the difficulty of maintaining symmetric flight.

REQUIREMENT GUIDANCE

The related MIL-F-8785C requirement is paragraph 3.3.8.

Recommended values:

Propulsion Type	Maximum Roll Control Force (lb)
Propeller	20
Other	10

As with similar requirements in the yaw axis, this paragraph distinguishes between propeller-driven and all other aircraft because of the normal crossflow effects due to turning propellers.

The applicability of this requirement is dependent upon specification of dives by the procuring activity. Ten pounds of control force can easily be held with one hand, and twenty pounds is manageable.

REQUIREMENT LESSONS LEARNED

5.5.9.5.2 Roll axis control force limits in dives and pullouts-verification.

Verification shall be by analysis, simulation and flight test.

VERIFICATION RATIONALE(5.5.9.5.2)

Flight measurement should be made during the required dives or upset maneuvers.

VERIFICATION GUIDANCE

Slight geometric asymmetries may produce rolling, yawing or hinge moments. Aeroelastic or Mach effects may be involved. Asymmetric loadings, either internal or external, will affect the roll control needed.

VERIFICATION LESSONS LEARNED

MIL-STD-1797A
APPENDIX A

4.5.9.5.3 Roll axis control force limits in crosswinds.

It shall be possible to take off and land in the crosswinds specified in 4.6.4 without exceeding the following roll control forces: _____.

REQUIREMENT RATIONALE(4.5.9.5.3)

This requirement is included to assure that roll control forces in crosswind takeoffs and landings are acceptable, within pilot capabilities and not overly burdensome.

REQUIREMENT GUIDANCE

The related MIL-F-8785C requirement is paragraph 3.3.7.

It is recommended that, as a maximum, roll control forces should be no greater than those specified by table XXXVI.

This is simply a method of insuring that crosswind operations do not require more roll control force than do normal rolling maneuvers. The takeoff and landing techniques, not specified, should be those normally employed in crosswind operation of that aircraft.

REQUIREMENT LESSONS LEARNED

5.5.9.5.3 Roll axis control force limits in crosswinds-verification.

Verification shall be by analysis, simulation and flight test.

VERIFICATION RATIONALE(5.5.9.5.3)

If the force at full roll control deflection is greater than the limit, measurements of sideslip and roll control force in crosswind operation should furnish the verification.

VERIFICATION GUIDANCE

From a safety aspect, actual takeoffs and landings in crosswinds may be impractical for Level 2 operation. However, actual takeoffs and landings need to be made in crosswinds up to the specified values in order to demonstrate compliance in Level 1 operation. At the Air Force Flight Test Center, for one place, there should be little difficulty in finding appropriate crosswinds for a flight-test buildup -- although the winds must be taken as they come.

VERIFICATION LESSONS LEARNED

MIL-STD-1797A
APPENDIX A

4.5.9.5.4 Roll axis control force limits in steady sideslips.

For Levels 1 and 2, positive effective dihedral (right roll control for right sideslip and left roll control for left sideslip) shall never be so great that more than _____ pounds of roll-stick force or _____ pounds of roll-wheel force is required for sideslip angles that might be experienced in service employment. In final approach the roll control forces shall not exceed _____ lb when in a straight, steady sideslip of _____ deg.

REQUIREMENT RATIONALE(4.5.9.5.4)

This requirement is included to insure that the amount of roll control force necessary to achieve a reasonable steady sideslip condition is never tiring for the pilot.

REQUIREMENT GUIDANCE

The related MIL-F-8785C requirements are paragraphs 3.3.6.3.2 and 3.3.7.1.

Maximum recommended control forces in service employment: 10 pounds of roll-stick force, 20 pounds of roll-wheel force.

Maximum recommended control forces in final approach:

Level 1:	10 lb
Levels 2 and 3:	20 lb

Sideslip specified should be same as for 4.6.6.1.

This requirement augments the yaw control power requirement of 4.6.6.1 to assure that coordinating roll forces in sideslips are reasonable.

REQUIREMENT LESSONS LEARNED

5.5.9.5.4 Roll axis control force limits in steady sideslips-verification.

Verification shall be by analysis, simulation and flight test.

VERIFICATION RATIONALE(5.5.9.5.4)

Verification will be in conjunction with 5.6.6.1.

VERIFICATION GUIDANCE

See 5.6.6.1 guidance.

VERIFICATION LESSONS LEARNED

MIL-STD-1797A
APPENDIX A

4.5.9.5.5 Roll axis control force limits for asymmetric thrust.

To meet the steady-state requirements of 4.6.5.1, 4.6.6.2 and 4.1.11.4 shall not require any roll control force greater than _____.

REQUIREMENT RATIONALE(4.5.9.5.5)

This requirement is intended to assure that roll control forces required to counter the effects of a failed engine are within the pilot's capabilities.

REQUIREMENT GUIDANCE

The related MIL-F-8785C requirements are paragraphs 3.3.9.2 and 3.3.9.4.

Recommended values are those specified by 4.5.9.2, according to the Level appropriate before thrust loss, except that with yaw controls free the Level 2 values may be used for Levels 1 and 2.

REQUIREMENT LESSONS LEARNED

5.5.9.5.5 Roll axis control force limits for asymmetric thrust-verification.

Verification shall be by analysis, simulation and flight test.

VERIFICATION RATIONALE(5.5.9.5.5)

Roll control force is to be determined in the course of verifying compliance with 4.6.5.1 and 4.6.6.2

VERIFICATION GUIDANCE

See 5.6.5.1 and 5.6.6.2 guidance.

VERIFICATION LESSONS LEARNED

MIL-STD-1797A
APPENDIX A

4.5.9.5.6 Roll axis control force limits for failures.

The change in roll control force required to maintain constant attitude following a failure in the flight control system shall not exceed _____ pounds for at least five seconds following the failure.

REQUIREMENT RATIONALE(4.5.9.5.6)

This requirement limits the degree of pilot distraction until corrective action can be taken, avoiding a possible flight safety problem.

REQUIREMENT GUIDANCE

The related MIL-F-8785C requirement is paragraph 3.5.5.2.

Recommended value: 10 pounds.

This value is consistent with the data of 4.5.9.

REQUIREMENT LESSONS LEARNED

5.5.9.5.6 Roll axis control force limits for failures-verification.

Verification shall be by analysis, simulation and flight test.

VERIFICATION RATIONALE(5.5.9.5.6)

Verification will be concurrent with verification for 4.6.7.9. Where there is a possibly serious flight safety problem, final verification may be via simulation with flight-authenticated data and actual flight hardware.

VERIFICATION GUIDANCE

The location of critical points in the flight envelope is highly dependent on the aerodynamic and flight control system configurations.

VERIFICATION LESSONS LEARNED

MIL-STD-1797A
APPENDIX A

4.5.9.5.7 Roll axis control force limits for configuration or control mode change.

The control force changes resulting from configuration changes or the engagement or disengagement of any portion of the flight control due to pilot action shall not exceed the following limits: _____.

REQUIREMENT RATIONALE(4.5.9.5.7)

Intentional engagement or disengagement of any portion of the flight control system should never result in unusual or unreasonable demands on the pilot to retain steady flight.

REQUIREMENT GUIDANCE

The related MIL-F-8785C requirement is paragraph 3.5.6.2.

It is recommended that for at least 5 seconds following the change, the change in roll force not exceed 10 pounds.

Trim transients following intentional pilot actions should obviously be small enough not to produce significant distractions. Do not over look such automatic changes as a switch to a different control mode when the pilot selects a particular weapon.

Since this requirement deals with intentional modification, it is implied that no failures have occurred, except where operating procedures call for the crew to switch modes upon experiencing a particular failure. Failures are covered explicitly by 4.5.9.5.5.

Satisfying this requirement requires careful design of the aircraft augmentation systems. This requirement also covers automatic configuration or control mode changes due to pilot action, as by selecting a weapon.

REQUIREMENT LESSONS LEARNED

5.5.9.5.7 Roll axis control force limits for configuration or control mode change-verification.

Verification shall be by analysis, simulation and flight test.

VERIFICATION RATIONALE (5.5.9.5.7)

This requirement supplements the quantitative requirement of 4.1.12.7; measurements should be made during verification of compliance with that requirement.

VERIFICATION GUIDANCE

The critical flight conditions are highly dependent on the aerodynamic and flight control system configurations.

VERIFICATION LESSONS LEARNED

4.6 Flying quality requirements for the yaw axis

4.6.1 Yaw axis response to yaw and side-force controllers

4.6.1.1 Dynamic lateral-directional response.

The equivalent parameters describing the oscillatory response in sideslip, yaw and roll to a yaw control input shall have the following characteristics: _____. These requirements shall be met in trimmed flight with cockpit controls fixed and with them free, and in steady maneuvers, in oscillations of any magnitude that might be experienced in operational use. If the oscillation is nonlinear with amplitude, the requirement shall apply to each cycle of the oscillation.

REQUIREMENT RATIONALE(4.6.1.1)

This requirement assures that any lateral-directional oscillatory (dutch roll) response to yaw controller will be sufficiently stable and well damped.

REQUIREMENT GUIDANCE

The related MIL-F-8785C requirement is paragraph 3.3.1.1.

Recommended minimum dutch roll frequency and damping are given in table XL. The parameters shall be found by matching the higher-order sideslip response to yaw control input to the following lower-order form, typically over the frequency range from 0.1 rad/sec to 10 rad/sec:

$$\frac{\beta}{F_{rp}} = \frac{K_{\beta} e^{-\tau_{e\beta} s}}{s^2 + 2\zeta_d \omega_d s + \omega_d^2}$$

Alternatively, when $|\phi/\beta|_d$ is large the ϕ/F_{as} equivalent-system transfer function of 4.5.1.4 shall be matched simultaneously with the equivalent system β/F_{as} transfer function:

$$\frac{\phi}{\delta_{as} \text{ or } F_{as}} = \frac{A_{\phi} [s^2 + 2\zeta_{\phi} \omega_{\phi} s + \omega_{\phi}^2] e^{-\tau_{e\phi} s}}{(s + 1/T_S)(s + 1/T_R) [s^2 + 2\zeta_d \omega_d s + \omega_d^2]}$$

$$\frac{\beta}{\delta_{as} \text{ or } F_{as}} = \frac{A_{\beta} (s + 1/T_{\beta_1})(s + 1/T_{\beta_2})(s + 1/T_{\beta_3}) e^{-\tau_{e\beta} s}}{(s + 1/T_S)(s + 1/T_R) [s^2 + 2\zeta_d \omega_d s + \omega_d^2]}$$

Use δ_{as} for deflection controls (pilot controller deflection commands the control effectors) and F_{as} for force controls (pilot controller force commands the control effectors).

The algorithms described in Appendix B are useful for the fitting process, although any mutually-agreed matching technique may be used. No limits are set on ϕ or β numerator terms at this time.

When $\omega_d^2 |\phi/\beta|_d$ is greater than 20 (rad/sec)², the minimum $\zeta_d \omega_d$ shall be increased above the $\zeta_d \omega_d$ minimums listed in table XL by:

$$\text{Level 1: } \Delta \zeta_d \omega_d = 0.014 (\omega_d^2 |\phi/\beta|_d - 20)$$

$$\text{Level 2: } \Delta \zeta_d \omega_d = 0.009 (\omega_d^2 |\phi/\beta|_d - 20)$$

MIL-STD-1797A
APPENDIX A

$$\text{Level 3: } \Delta\zeta_d\omega_d = 0.005(\omega_d^2 |\phi/\beta|_d - 20)$$

with ω_d in radians per second.

TABLE XL. Recommended minimum dutch roll frequency and damping.

LEVEL	FLIGHT PHASE CATEGORY	CLASS	MIN ζ_d^*	MIN $\zeta_d\omega_d^*$ (rad/sec)	MIN ω_d (rad/sec)
1	A (CO, GA, RR, TF, RC, FF, AS)	I, II, III, IV	0.4	0.4	1.0
	A	I, IV	0.19	0.35	1.0
		II, III	0.19	0.35	0.4
	B	All	0.08	0.15	0.4
	C	I, II-C, IV	0.08	0.15	1.0
II-L, III		0.08	0.10	0.4	
2	All	All	0.02	0.05	0.4
3	All	All	0	--	0.4

* - The governing damping requirement is that yielding the larger value of ζ_d , except that a ζ_d of 0.7 is the maximum required for Class III.

Allowable dutch roll oscillatory characteristics are specified in terms of minimum values of ζ_d , ω_d , and $\zeta_d\omega_d$; the last is also a function of $|\phi/\beta|_d$ when $|\phi/\beta|_d$ is very large. From examination of supporting data it was apparent that over a wide range of frequencies and $|\phi/\beta|_d$ response ratios, lines of constant damping ratio (ζ_d) fit the data quite well. In determining the minimum frequency (ω_d) boundaries, it was found that the more closely the low-frequency data were examined, the more difficult it became to assess the importance of low dutch roll frequency per se. Not surprisingly, there is support for raising the minimum acceptable value of ζ_d when ω_d is low, i.e., ζ_d and ω_d are not independent. This is reflected by specifying a minimum for the total damping ($\zeta_d\omega_d$).

The total damping has also been made a function of the product $\omega_d^2 |\phi/\beta|_d$. While the data to support this are sparse, there is a clear need to account for possible turbulence effects on aircraft with high dutch roll frequencies and high $|\phi/\beta|_d$.

Limits on τ_{e_β} have not been specified. It is expected that τ_{e_β} is not as critical as delays in the pitch and roll axes, since the pilot does not normally perform high-gain precision tracking of sideslip with the yaw control. The cases in which time delay has been especially important have had aggressive closed-loop tracking inherent to the flying task.

SUPPORTING DATA

Because of the fundamental nature of this requirement there is a reasonably large data base wherein ζ_d , ω_d , and $|\phi/\beta|_d$ have been varied in a systematic manner. However, a review of the pilot ratings reveals that the Level 1 minimum ζ_d ($\zeta_d \geq 0.4$) is not supported. Nevertheless, stability augmentation has allowed the easy

MIL-STD-1797A
APPENDIX A

realization of such large values of ζ_d . Given the option of larger ζ_d values, pilots have found significant improvements in tracking performance, both air-to-air (CO) and air-to-ground (GA) -- hence the recommendation from AFFTC to set ζ_d at 0.4 for these tasks. In our judgment the other Category A Flight Phases also need this higher damping. Similarly for Categories B and C, although not supported by the data presented, some opinion is the 0.08 should be 0.12.

It should also be recognized that recent years have seen a large increase in the emphasis on aggressive pilot behavior in flight test experience, as well as in military operations. This would also be expected to have the effect of increasing the minimum levels of ζ_d which were quite low. It is expected that future experiments will show a need for increasing the minimum ζ_d for other aircraft Classes and Flight Phase Categories. A request never adopted into MIL-F-8785B was to require much greater dutch roll damping in order to prolong fatigue life, based on B-52 experience.

The supporting data that currently exist will be reviewed for each Flight Phase Category in the following paragraphs.

1. Categories A and B

Since most of the available flight test reports involve either open-loop rolling or landing approach tasks, there is very little data for substantiating Category A requirements. As a result, much of the data presented here may be more applicable to Category B Flight Phases. The data will be compared with the limits in table XL for both Flight Phases.

NASA-TN-D-1141 contains some of the pilot ratings that were used to formulate the Category B limit on ζ_d in MIL-F-8785B. As shown on figure 208, the correlation is not very strong. The tasks were essentially open-loop: abrupt coordinated turn entries through 45 to 60 deg bank-angle; abrupt aileron reversals with coordinated rudder; and rudder-fixed and -free 360 deg bank-angle rolls. All that can really be concluded is that for $\omega_d = 1.9$ rad/sec, ζ_d of 0.10 is marginally Level 2. The data are included here only because they were used in AFFDL-TR-69-72 to support the dutch roll requirements.

Equally ambiguous data, obtained from Cornell Aero Lab Rpt TB-574-F-3, are presented in figure 209. The flight test program performed in an F4U-5 airplane, included both Category A and B type tasks-release from a steady sideslip; entry into and recovery from a 45 deg banked turn and a standard-rate turn (in simulated instrument flight); and "tracking of any available target in approximately level flight." Therefore, figure 209 includes the Level 1 boundaries for both Category A and B Flight Phases from table XL. It is seen that the ratings given support the Category B boundary quite well, but do not show support for the Category A boundary. But, again, this is likely a consequence of the test maneuvers.

Fixed-base simulator data from IAS Paper 60-18 (figure 210) are again more supportive of the Category B boundaries. Tasks included entry to and exit from a standard rate turn; abrupt directional kicks and releases; 60 and 90 deg rolls; and abrupt rolls at elevated load factors (3-4 g). (Not surprisingly, the latter maneuvers added little to the pilots' evaluations, since the tests were conducted in a fixed-base simulator.)

MIL-STD-1797A
APPENDIX A

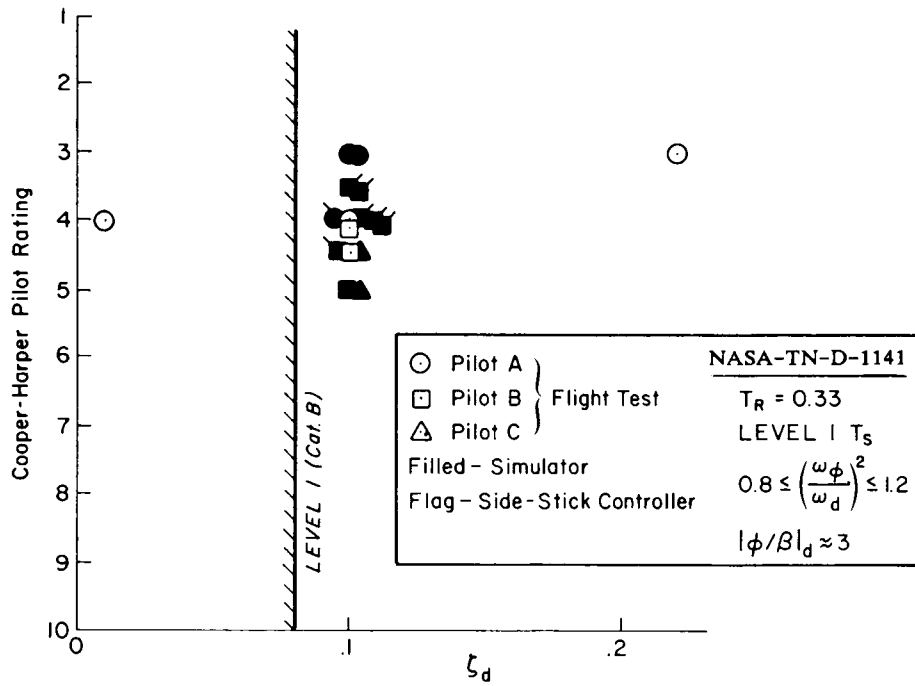

FIGURE 208. Effect Of ζ_d on pilot ratings for in-flight and fixed-base simulations of NASA-TN-D-1141 $\omega_d = 1.78 - 1.90$ rad/sec (Category B).

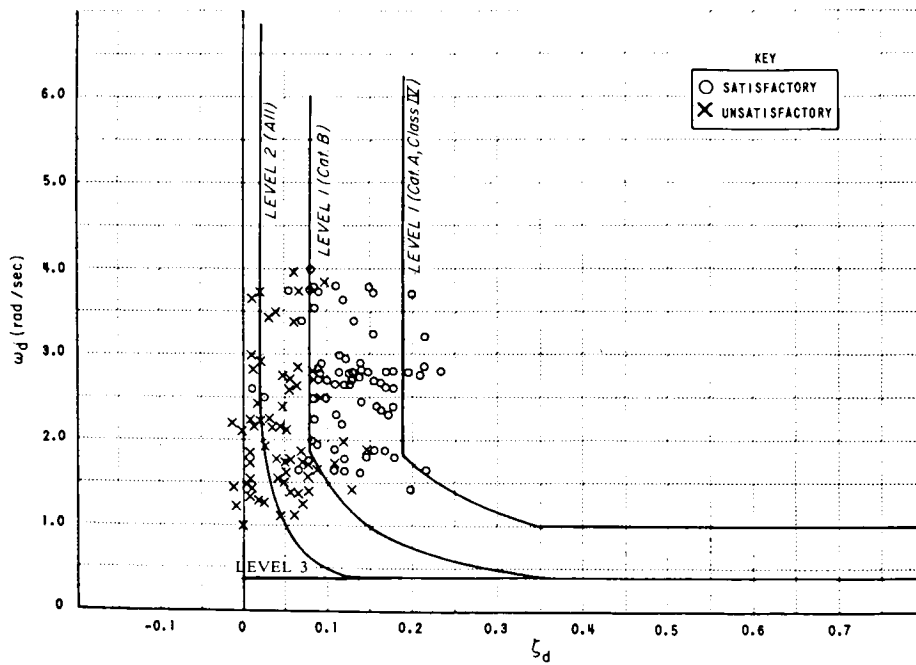

FIGURE 209. Dutch roll data (from Cornell Aero Lab Rpt TB-574-F-3).

MIL-STD-1797A
APPENDIX A

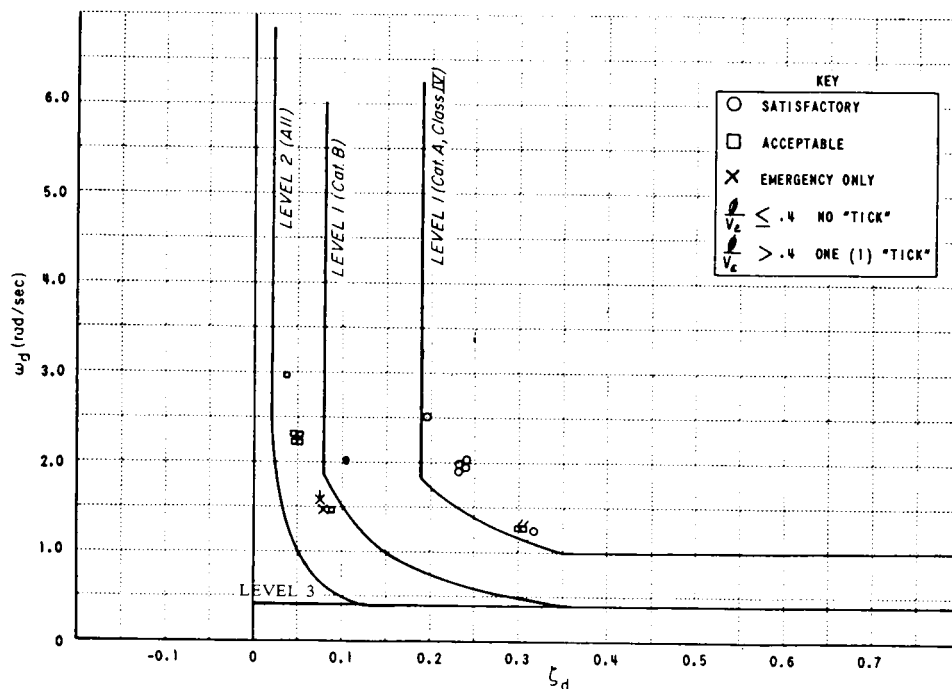

FIGURE 210. Dutch roll data (from IAS Paper 60-18).

Figure 211 shows data from the fixed-base simulations of ASD-TDR-61-362. Based upon the re-entry mission simulated, and upon the specific maneuvers performed, the data should be considered applicable to the Category B Flight Phases. As stated in ASD-TDR-61-362, "The overall mission was described as the re-entry, descent and landing of a re-entry vehicle. In particular, each pilot was told that this mission did not require high maneuverability but did require fairly precise control of attitude." Tasks included straight flight, turning flight with shallow and steeply banked turns of up to 60 deg bank angle, and tracking of roll and sideslip random inputs and minimizing pitch disturbances.

It is not clear from ASD-TDR-61-362 if the pitch disturbances occurred simultaneously with the lateral-directional random inputs, but it is possible that this could have affected pilot ratings.

The data of figure 211 fit the table XL criteria quite well for $\omega_d = 1$ if the Level 1 limits are taken for Category A, and Class IV aircraft. For higher ω_d the Category B Level 1 boundary fits better.

ASD-TDR-61-362 provides data for evaluating the additional damping requirements of table XL. A $\Delta\zeta_d \omega_d$ is specified when the product $\omega_d^2 |\phi/\beta|_d$ is greater than 20 (rad/sec)². The effects of this on the boundaries can be seen by comparing figures 211a through 211d for increasing values of $\omega_d^2 |\phi/\beta|_d$. The data of figures 211b, c and d correlate well with the boundaries drawn. It should be noted, however, that the high $\omega_d^2 |\phi/\beta|_d$ data correlate just as well with the basic boundaries of figure 211a. More data would be desirable to validate this requirement.

MIL-STD-1797A
APPENDIX A

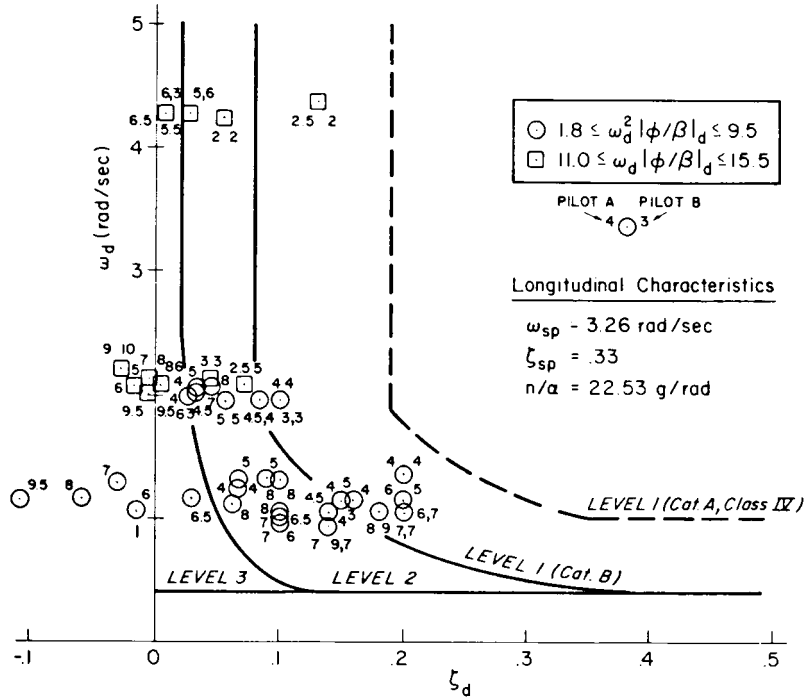

a) $\omega_d^2 |\phi/\beta|_d < 20 (rad/sec)^2$

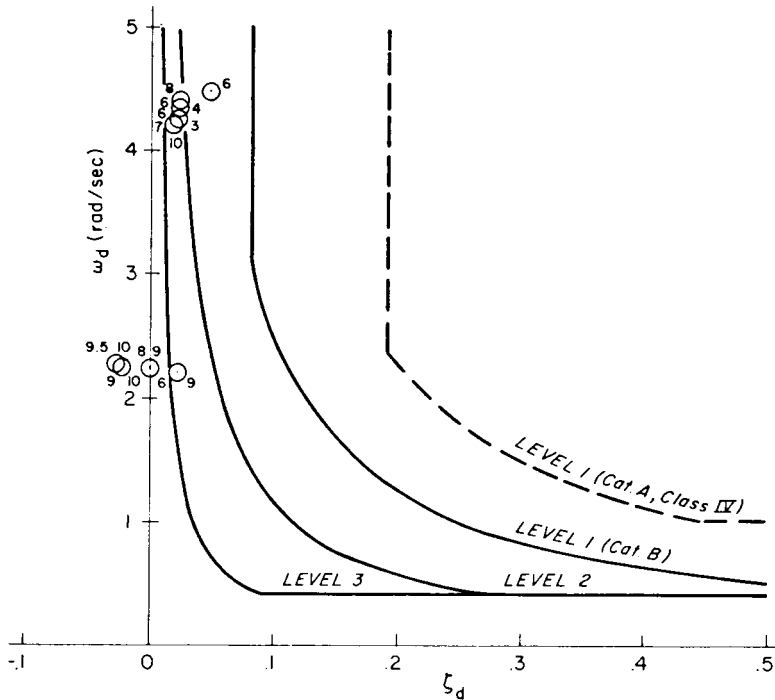

b) $25.0 \leq \omega_d^2 |\phi/\beta|_d \leq 28.8 (rad/sec)^2$; Boundaries Drawn for 27.0

FIGURE 211. Dutch roll data from fixed-base simulation of re-entry task
(ASD-TDR-61-362) $T_R \approx 0.40$ sec, $T_S \approx \infty$.

MIL-STD-1797A
APPENDIX A

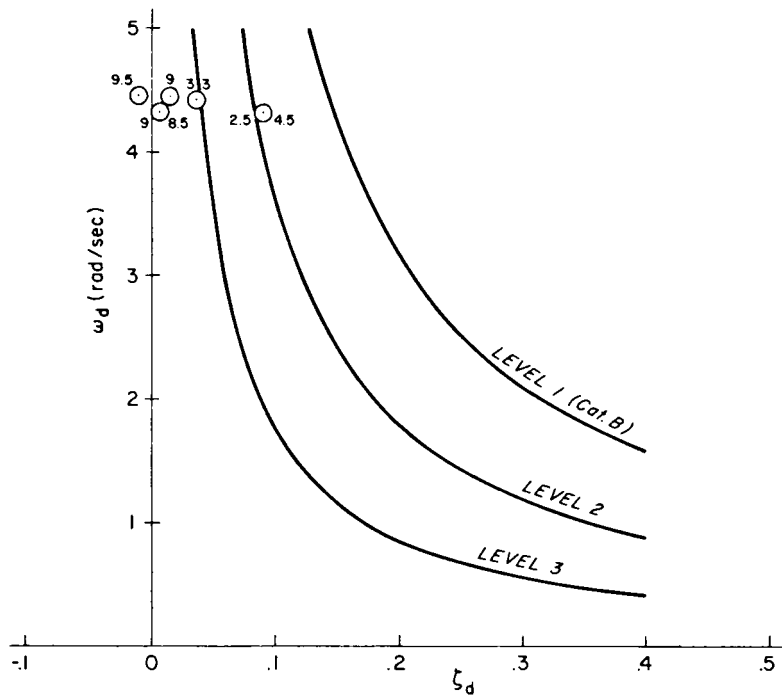

c) $53.5 \leq \omega_d^2 |\phi/\beta|_d \leq 55.5 \text{ (rad/sec)}^2$; Boundaries Drawn for 54.5

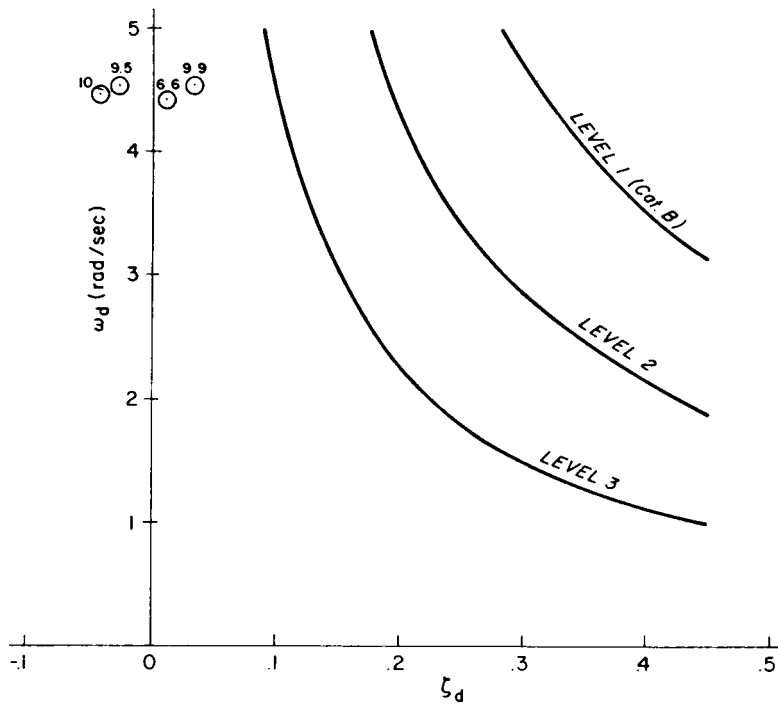

d) $97.9 \leq \omega_d^2 |\phi/\beta|_d \leq 116.5 \text{ (rad/sec)}^2$; Boundaries Drawn for 110.0

FIGURE 211. Dutch roll data from fixed-base simulation of re-entry task (ASD-TDR-61-362) $T_R \approx 0.40 \text{ sec}$, $T_S \approx \infty$ - Continued.

MIL-STD-1797A
APPENDIX A

Data from NASA-CR-778 for fixed-base and in-flight simulations using the USAF/Calspan T-33 are presented in figures 212 and 213. Only those configurations for which the pitch, roll, and spiral characteristics were Level 1, and for which $(\omega_\phi/\omega_d)^2$ was between about 0.8 and 1.2 are plotted. [Multiple ratings in figures 212 and 213 are in some cases due to differing values of $(\omega_\phi/\omega_d)^2$; in general, the best ratings shown for any data point are for $(\omega_\phi/\omega_d)^2 = 1.0$.] The tasks of NASA-CR-778 are clearly Category B, i.e., a re-entry vehicle flown in straight flight and turning flight with shallow (30 deg bank angle) and medium (60 deg) banked turns, and rolling turns of up to 180 deg bank. Additionally, the maneuvers were performed while a random noise signal was fed to the elevator, aileron and rudder actuators. These noise effects caused pilot rating degradations of 0 to 1-1/2 rating points. The data of figure 212 (for low values of 2 the parameter $\omega_d^2 |\phi/\beta|_d$) support the Category B Level 1 damping boundary. Data for large values of $\omega_d^2 |\phi/\beta|_d$ are shown in somewhat different form (figure 213). Only one configuration [the in-flight 2 simulation with $\zeta_d \omega_d = 0.17$ rad/sec, $\omega_d^2 |\phi/\beta|_d = 29.4$ (rad/sec)²] shows support for increasing the damping requirements as $\omega_d^2 |\phi/\beta|_d$ increases. All other data fit the basic requirement ($\zeta_d \omega_d > 0.15$ rad/sec for Level 1).

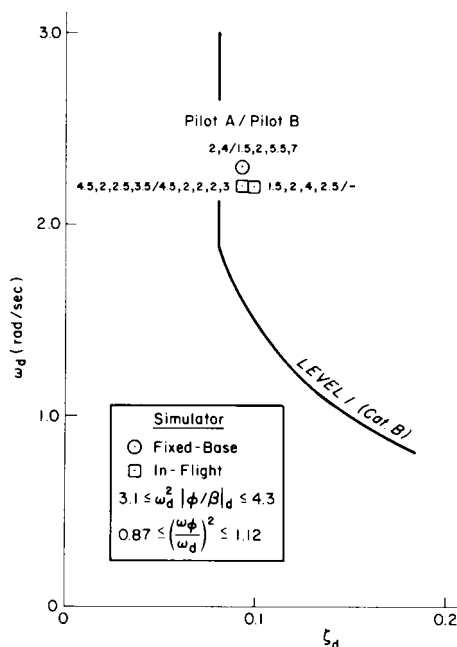

FIGURE 212. Dutch roll data (from NASA-CR-778; low $\omega_d^2 |\phi/\beta|_d$).

Flight-test data of WADD-TR-61-147, again simulating entry vehicles (and using the same maneuvers as for NASA-CR-778), are presented in figures 214 and 215. Figure 214 includes all applicable data from WADD-TR-61-147 [i.e., those data for which t_{ζ_p} , ω_{sp} , T_S and T_R are Level 1, and $(\omega_\phi/\omega_d)^2 = 1$].

The low pilot ratings for cases with low $\omega_d^2 |\phi/\beta|_d$ may be due to variations in other parameters (e.g., roll control effectiveness) rather than to dutch roll characteristics. Most of the data in figure 214 fit the boundaries (drawn for low $\omega_d^2 |\phi/\beta|_d$) quite well. The high $\omega_d^2 |\phi/\beta|_d$ data are reproduced in figure 215 (excluding the cases that are Level 2 or 3 based on the boundaries of figure 214). The points that lie at $\omega_d^2 |\phi/\beta|_d > 79$ (rad/sec)² indicate support for the table XL $\zeta_d \omega_d$ requirements. However, two points at $\zeta_d \omega_d = 0.4 - 0.5$ and $\omega_d^2 |\phi/\beta|_d = 53 - 54$ (PR = 3) suggest that the boundaries may need refinement.

MIL-STD-1797A
APPENDIX A

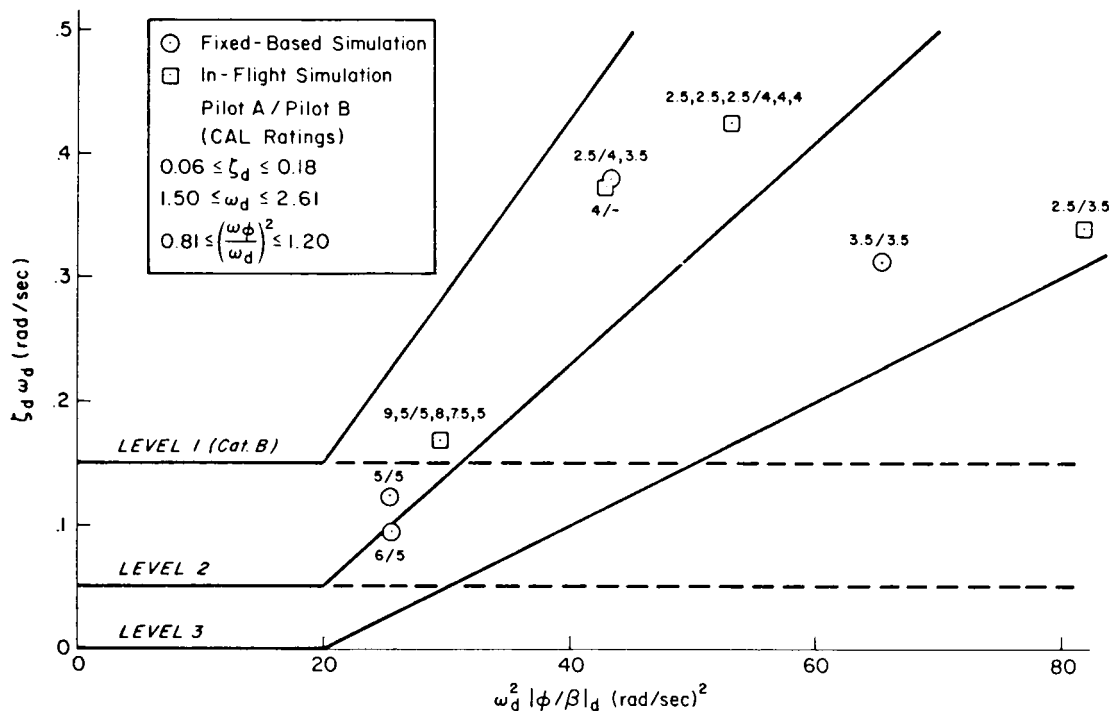

FIGURE 213. Dutch roll data (from NASA-CR-778; high $\omega_d^2 |\phi/\beta|_d$).

Applicable data points from the in-flight simulation of AFFDL-TR-67-98 are shown on figure 216. The maneuvers included straight and turning flight, as well as a bank angle command tracking task and flight with artificial disturbances. Many of the points that lie in the Level 2-to-3 region on figure 216 do not support the boundaries.

Summarizing the Category A/B data presented, there appears to be a definite trend of increased rating with increasing $\omega_d^2 |\phi/\beta|_d$. However, the $\zeta_d \omega_d = 0.15$ points show a scarcity of good data for Category A Flight Phases, especially at low values of ω_d . While the Level 2 and 3 boundaries are reasonably well supported by pilot ratings, some simulation data strongly support it, while other data strongly refute it. (The origins of this requirement will be discussed shortly, after analysis of available Category C data.)

MIL-STD-1797A
APPENDIX A

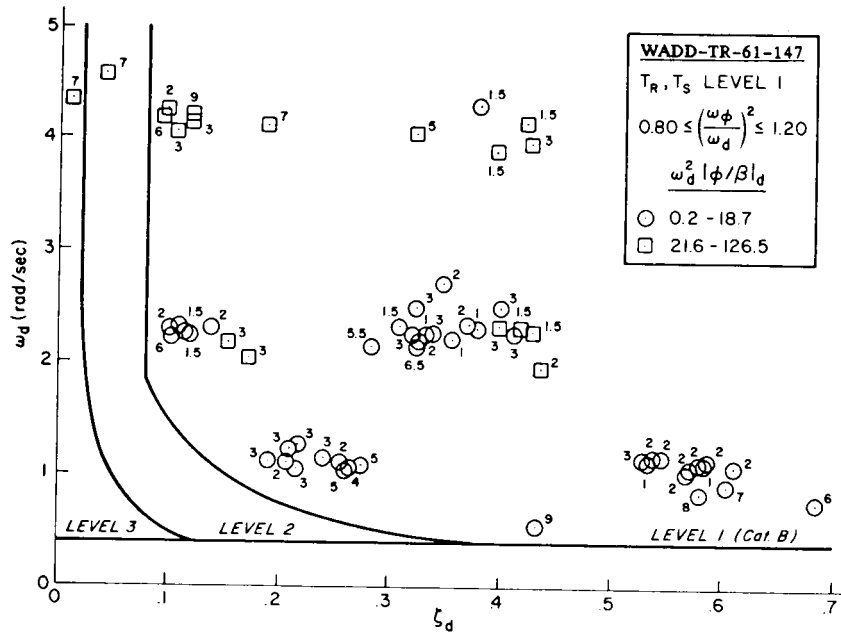

FIGURE 214. Dutch roll data (from WADD-TR-61-147).

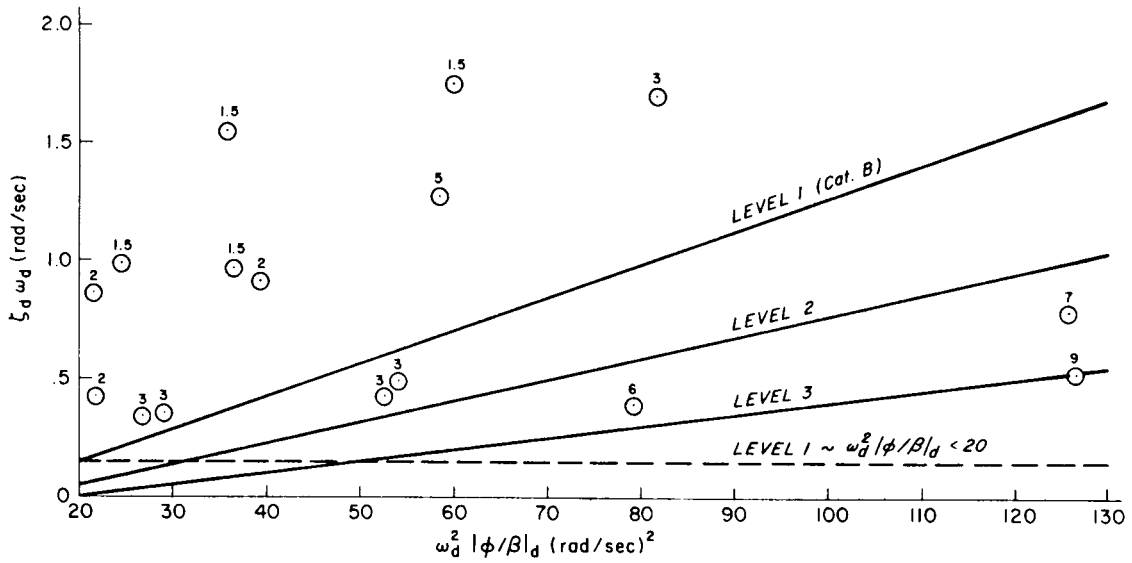

FIGURE 215. Data for high $\omega_d^2 |\phi/\beta|_d$ (from WADD-TR-61-147).

MIL-STD-1797A
APPENDIX A

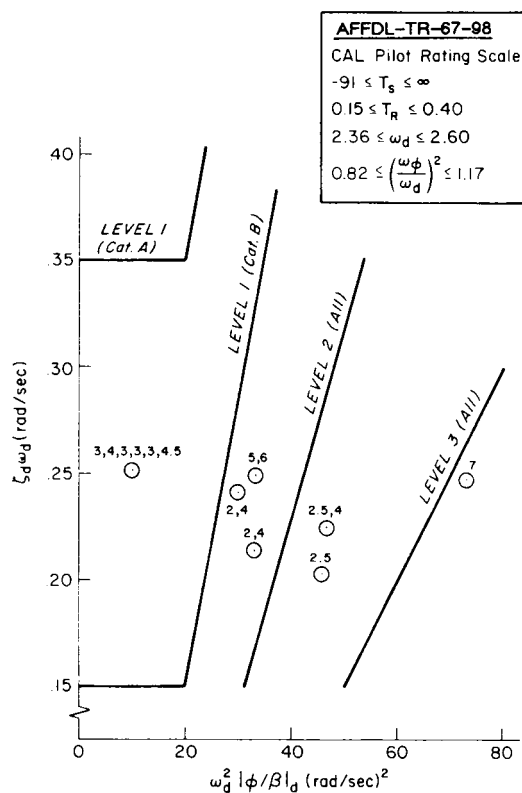

FIGURE 216. Dutch roll data from in-flight simulation of AFFDL-TR-67-98.

2. Category C

The most complete set of data available for Category C Flight Phases comes from NASA Memo 12-10-58A. The flight test program utilized a variable-stability F-86E with seven evaluation pilots. Details of the task are unknown; though the test flight conditions were 10,000 ft altitude at 170 KEAS, the report states that "Ratings were given for the landing-approach condition only." Ratings were based on controls-fixed characteristics, and handling qualities in smooth and simulated rough air. The rough air "corresponded to pilot A's impression of moderate to heavy turbulence." Aileron yaw ($N_{\delta_{as}}$) was optimized by the pilots for each condition. Data are presented in NASA Memo 12-10-58A in terms of oscillation period and time and cycles to half (or double) amplitude. These have been converted to equivalent dutch roll damping ratio and frequency for presentation in figures 217 and 218. The spiral and roll modes, however, are not known, and may have influenced the values of $1/T_{1/2}$ and $1/C_{1/2}$ reported in NASA Memo 12-10-58A. The subscript "equiv" is added to ζ_d and ω_d in figures 217 and 218 to indicate that the equivalent value may include spiral and roll mode effects.

The low- ω_d data of NASA Memo 12-10-58A plotted on figure 217 are seen to correlate with the table XL boundaries quite well. The few data points with large $|\phi/\beta|_d$ generally show a degradation in pilot rating. However, the high- ω_d data (figure 218), for which the parameter $\omega_d^2 |\phi/\beta|_d$ is large, do not show this degradation. In fact, these data strongly support the basic damping requirements of table XL.

MIL-STD-1797A
APPENDIX A

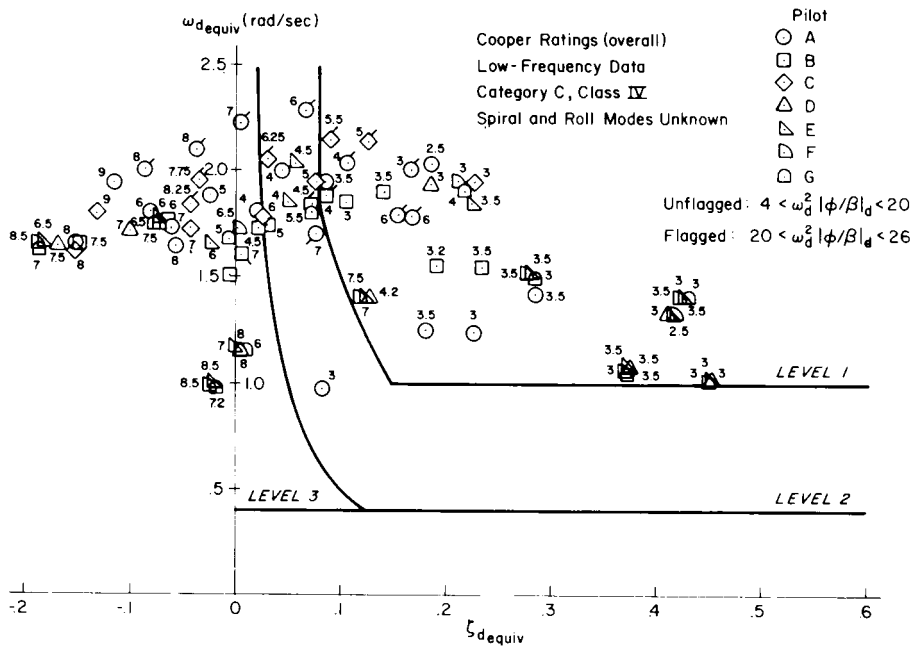

FIGURE 217. Dutch roll data from flight tests of NASA Memo 12-10-58A (F-86E; low-frequency data).

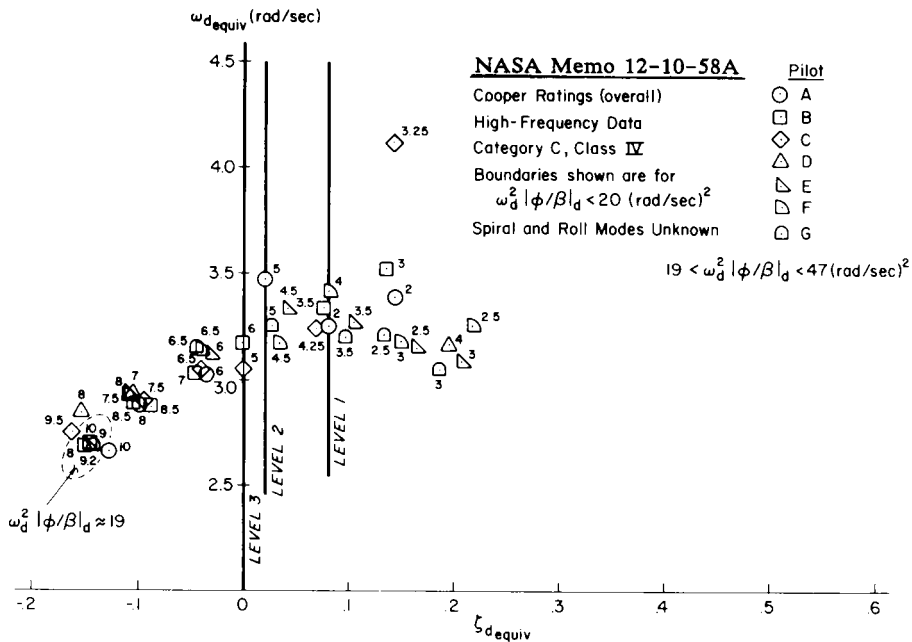

FIGURE 218. Dutch roll data from flight tests of NASA Memo 12-10-58A (F-86E; high-frequency data).

MIL-STD-1797A
APPENDIX A

Power approach tests conducted with the Princeton variable-stability Navion (Princeton Univ Rpt 797) also show limited support for the Category C requirements, figure 219.

In the flight program of AFFDL-TR-70-145, the USAF/Calspan T-33 was flown as a medium-weight Class II aircraft. Cooper-Harper ratings for $N_{\delta_{as}} = 0$ (figure 220) support the boundaries for ζ_d , though the Level 2 limit could possibly be relaxed; but there are no data for $\omega_d < 1.0$ rad/sec, and the few low-frequency points suggest that, for level 1, $\omega_{d_{min}} = 1.0$ rad/sec might be more appropriate. But there is too little data to justify an increase in minimum ω_d from 0.4 to 1.0 rad/sec for Class II-L aircraft. These data show a dramatic effect of turbulence on pilot rating (see * in figure 220). This could be evidence that turbulence is a dominant factor in setting limits on ζ_d . Future experiments should concentrate on this area. Additionally, any evaluation program should include moderate turbulence.

The Category C frequency and damping ratio boundaries for Class III aircraft are supported by moving-base simulator data from NASA-TN-D-3910 (figure 221). Evaluation tasks consisted of turn entries and recoveries, roll reversals, sideslips, and dutch roll oscillations; instrument approaches; and instrument approaches with lateral offsets. Similar tests were flown on the variable-stability B-367-80 transport (including landing). While detailed data are not reported in NASA-TN-D-3910 for the flight tests, pilot ratings for a similar range of ζ_d , ω_d , and $(\omega_{sp}/\omega_d)^2$ show general agreement with the simulator data (figure 220). A major difference is the apparent insensitivity to $(\omega_{sp}/\omega_d)^2$ in flight tests.

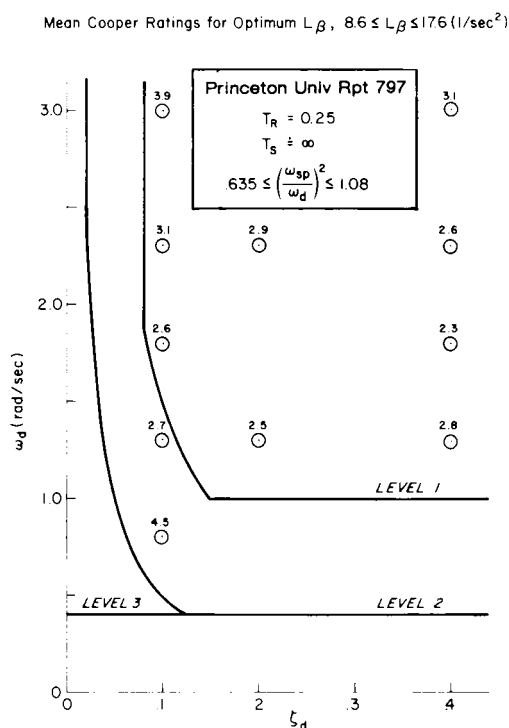

FIGURE 219. Dutch roll data from in-flight simulation of Princeton Univ Rpt 797 (Navion; pilot ratings shown for optimum values of L_{β}).

MIL-STD-1797A
APPENDIX A

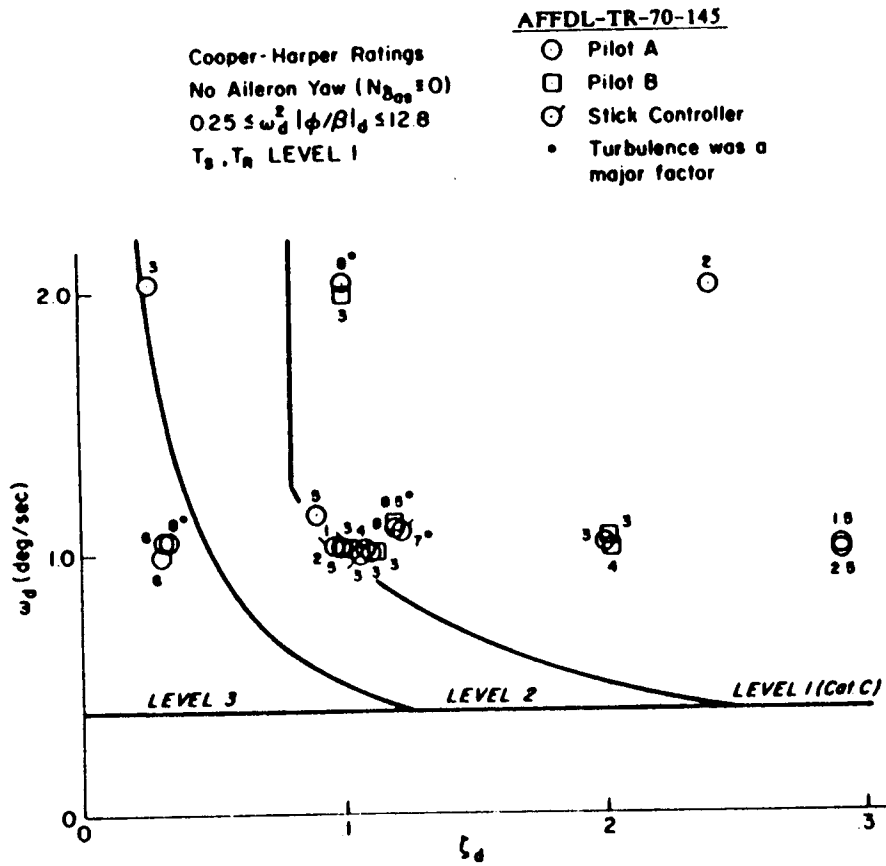

FIGURE 220. Dutch roll data from In-flight simulation of Class II-L airplanes in landing approach (T-33; AFFDL-TR-70-145).

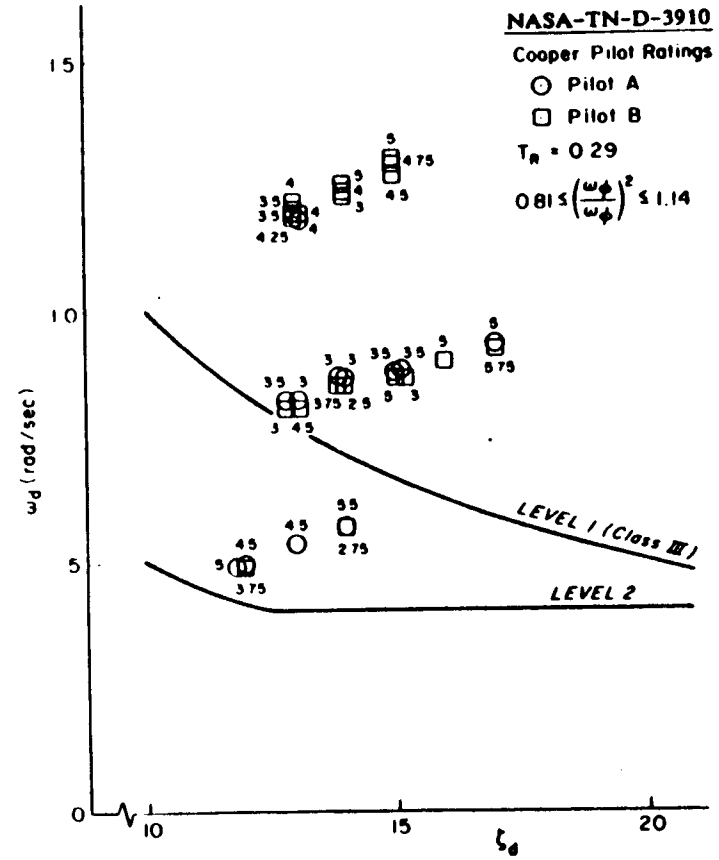

FIGURE 221. Dutch roll data from moving-base - bank simulator tests of NASA-TN-D-391TR-(supersonic transport).

MIL-STD-1797A
APPENDIX A

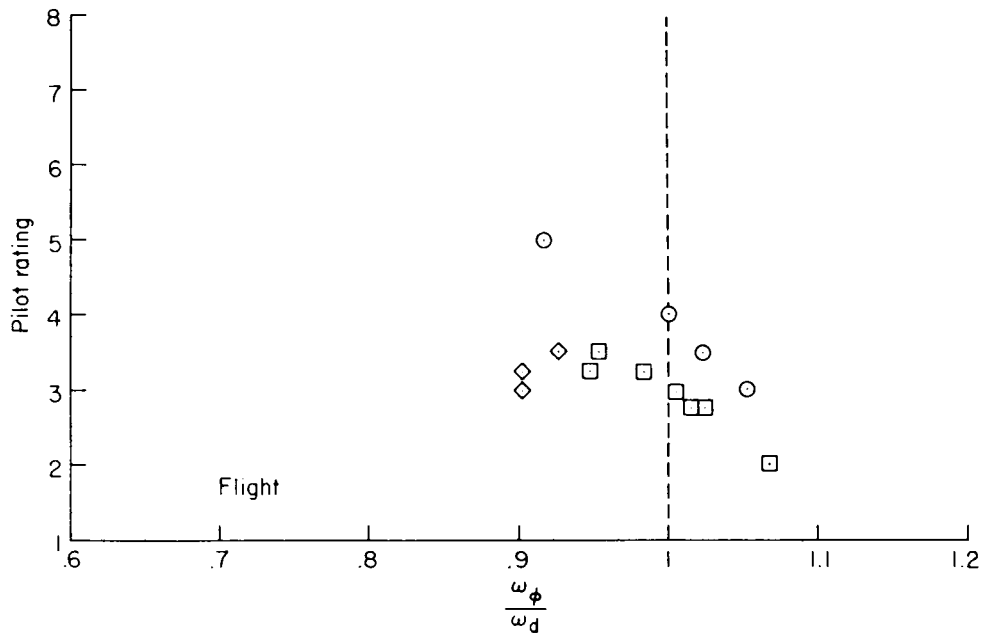
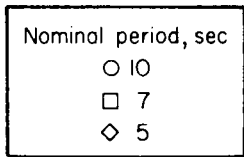
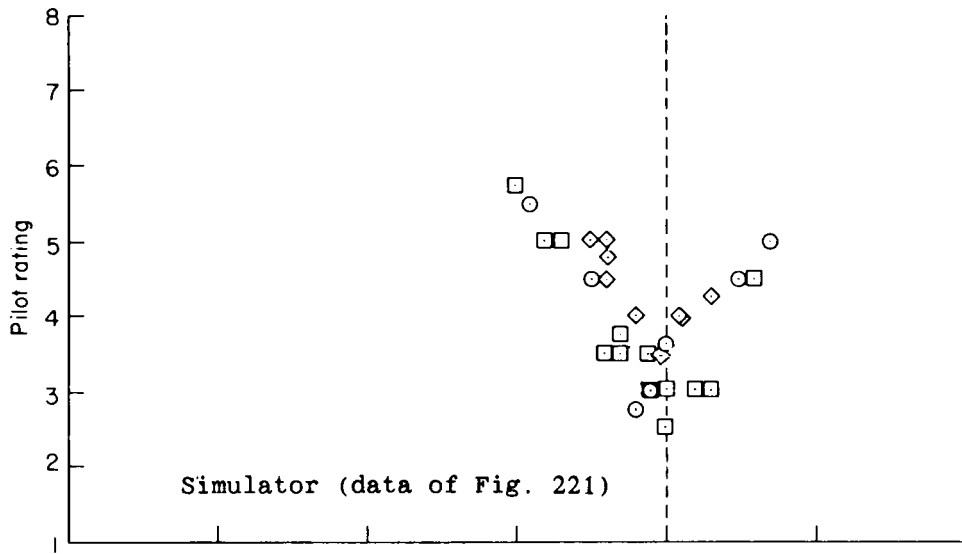

FIGURE 222. Variation of pilot rating with ω_ψ/ω_d for moving-base simulator and flight data $\zeta_d \approx 0.15$ (NASA-TN-D-3910).

MIL-STD-1797A
APPENDIX A

From the preceding review of available Category C data, it is clear that there is a lack of good, solid data; that few tests include touchdown and landing as a task; but that, as for Categories A and B, there is some mild support for the boundaries as they exist. If the table XL limits are to be refined or developed to be consistent and valid, much more testing is necessary.

3. Effect of $\omega_d^2 |\phi/\beta|_d$

The criterion first proposed in AFFDL-TR-65-138, in which the value of $\zeta_d \omega_d$ required to maintain a given pilot rating is made a function of $\omega_d^2 |\phi/\beta|_d$ (figure 223), has been retained in the lateral-directional oscillatory requirements of table XL. It is observed that $\omega_d^2 |\phi/\beta|_d$ is analogous to $|\phi/\beta|_d$. The data upon which the curve of figure 223 is based, from WADC-TR-52-298, are presented in figures 224 and 225.

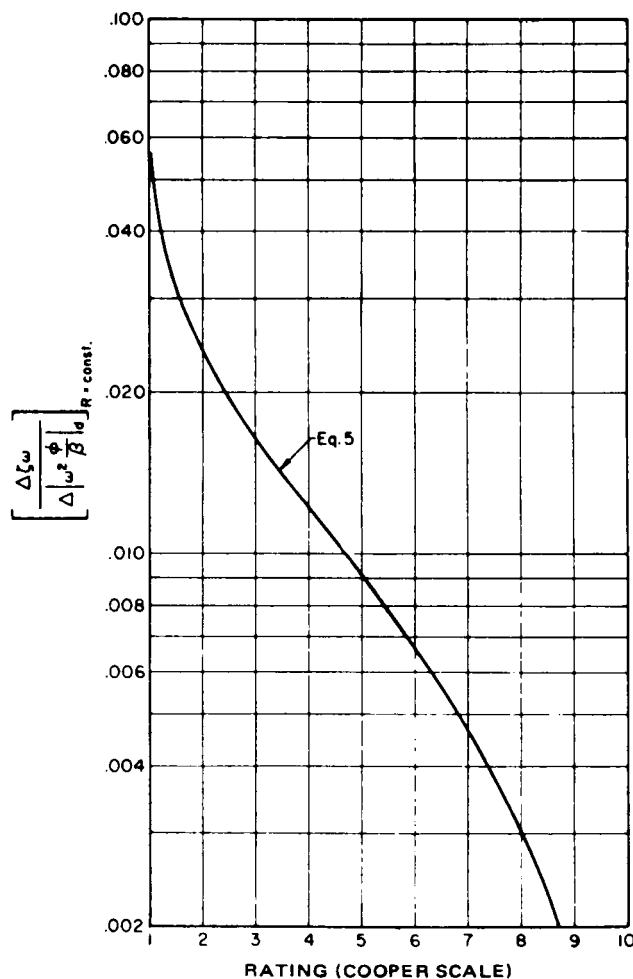

FIGURE 223. $\Delta \zeta \omega / \Delta (\omega_d^2 |\phi/\beta|_d)$ required to maintain a given basic rating (from AFFDL-TR-70-145), based upon data of figures 224 and 225.

MIL-STD-1797A
APPENDIX A

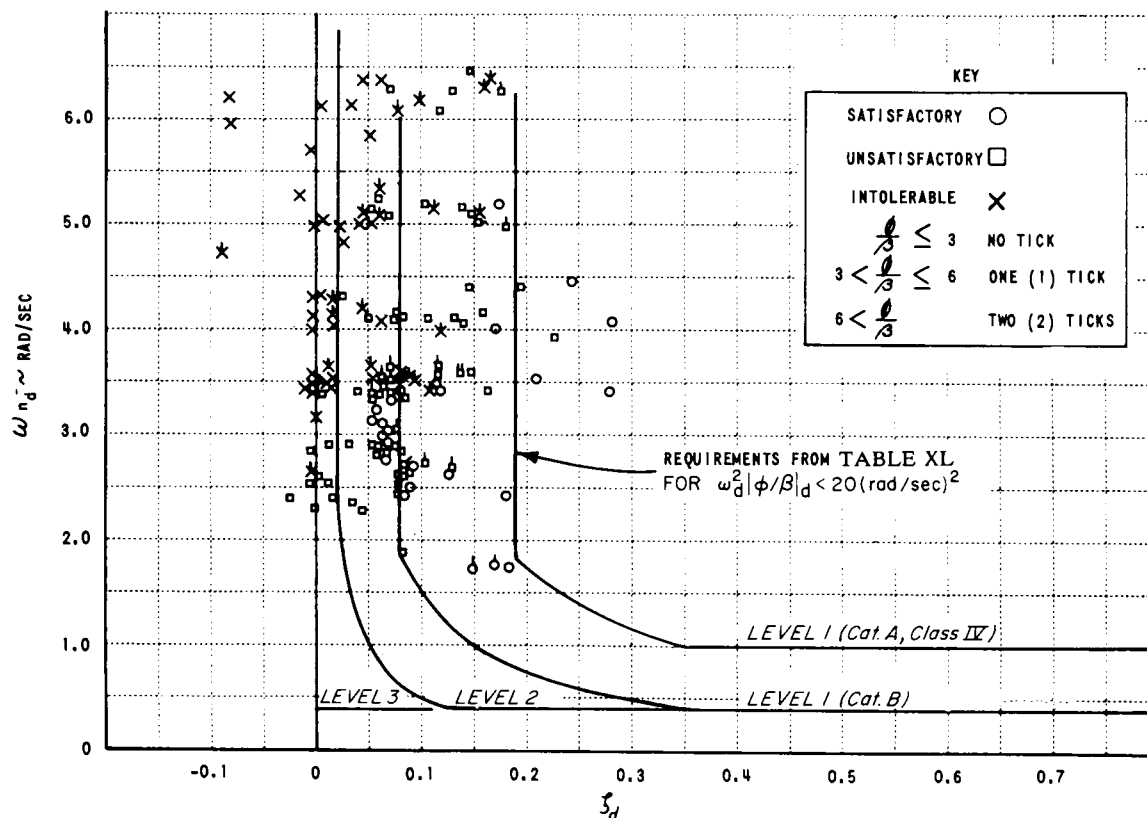
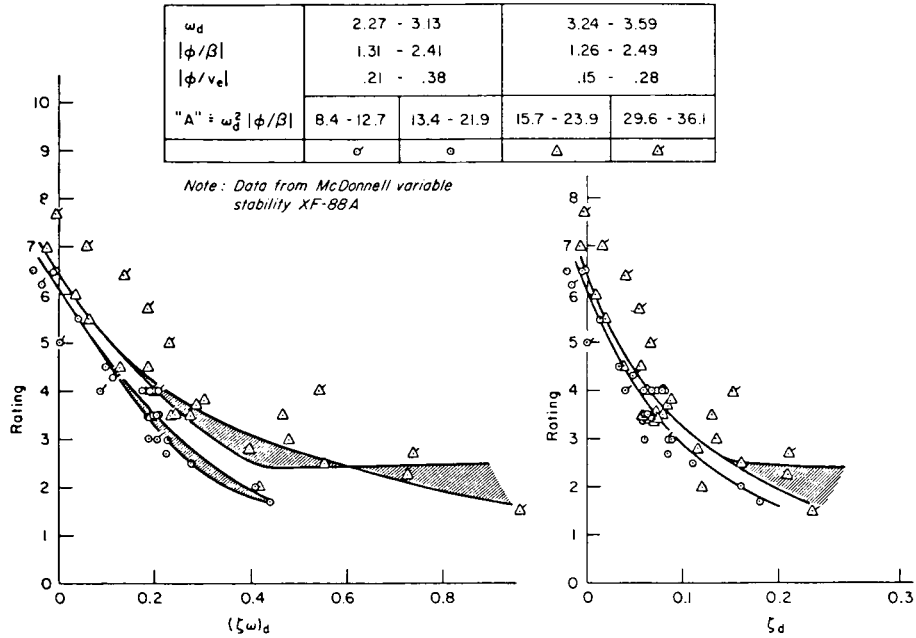

FIGURE 224. Dutch roll data from controls-fixed rudder kicks of WADC-TR-52-298 compared to limits of table XL.

Due in part to the lack of agreement between more recent test data and the $\omega_d^2 |\phi/\beta|_d$ requirements, the basis for these requirements will be reviewed here. The $\Delta\zeta_d\omega_d$ requirements of table XL were determined from rudder kicks, and the dutch roll requirement specifies a yaw disturbance input; but the bulk of existing test data presented in support of the table XL requirements comes from banking tasks. Most of these data do not show very strong support for the $\Delta\zeta_d\omega_d$ requirement (e.g., figures 213, 215, 216, 217, and 218). In fact, for the more than 100 data points shown in figures 211 through 218 with $\omega_d^2 |\phi/\beta|_d > 20$, correlation with either the basic $\zeta_d\omega_d$ or additional $\Delta\zeta_d\omega_d$ requirement is almost identical -- about 60 percent. The big difference is that, of the pilot ratings that do not correlate, 50 percent are better than the basic requirement and 80 percent better than the $\Delta\zeta_d\omega_d$ requirement. (That is, either criterion will generally predict flying qualities at the same confidence level, but the $\Delta\zeta_d\omega_d$ requirement is -- obviously -- the more conservative.)

MIL-STD-1797A
APPENDIX A



a) "Low Frequency"

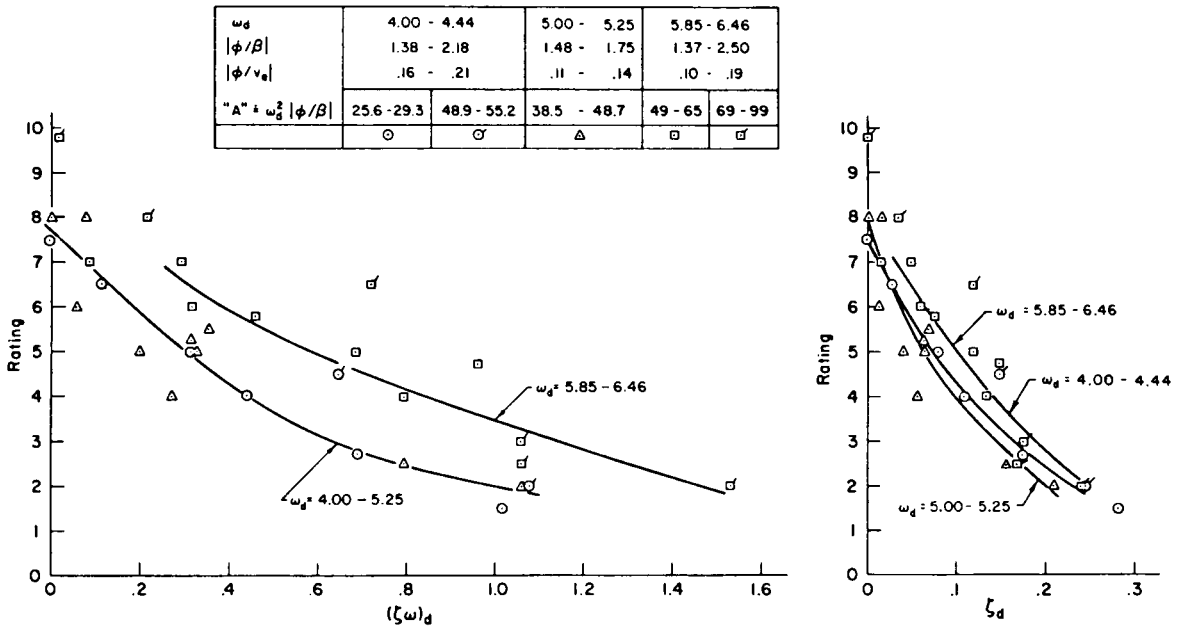

b) "High Frequency"

FIGURE 225. Data upon which relation of figure 223 are based (controls-fixed rudder kicks, WADC-TR-52-298; figure reproduced from AFFDL-TR-65-138).

MIL-STD-1797A
APPENDIX A

It has long been recognized that pilot acceptance of dutch roll oscillations is influenced by $|\phi/\beta|_d$, and it is for this reason that the $\Delta\zeta_d\omega_d$ requirements have been retained. However, the inconsistency of the supporting data should serve as a reminder that a better method is needed for dealing with aircraft with large $|\phi/\beta|_d$ ratios. But so far nothing adequate has been suggested. The 4.5.1.4 limits on roll rate oscillations do place one lower bound on ζ_d as a function of ω_ϕ , ω_d and roll-sideslip phasing.

REQUIREMENT LESSONS LEARNED

Figure 226 illustrates the range of dutch roll damping and frequency found on some existing airplanes (AGARD-CP-17). Airplanes include the B-52, B-58, B-70, C-130, C-141, C-5A, F-104, F-105, F-4D, A-7D, F-111, Boeing 707-300, 720B, 727, and an SST design. The symbols shown are for several different flight conditions.

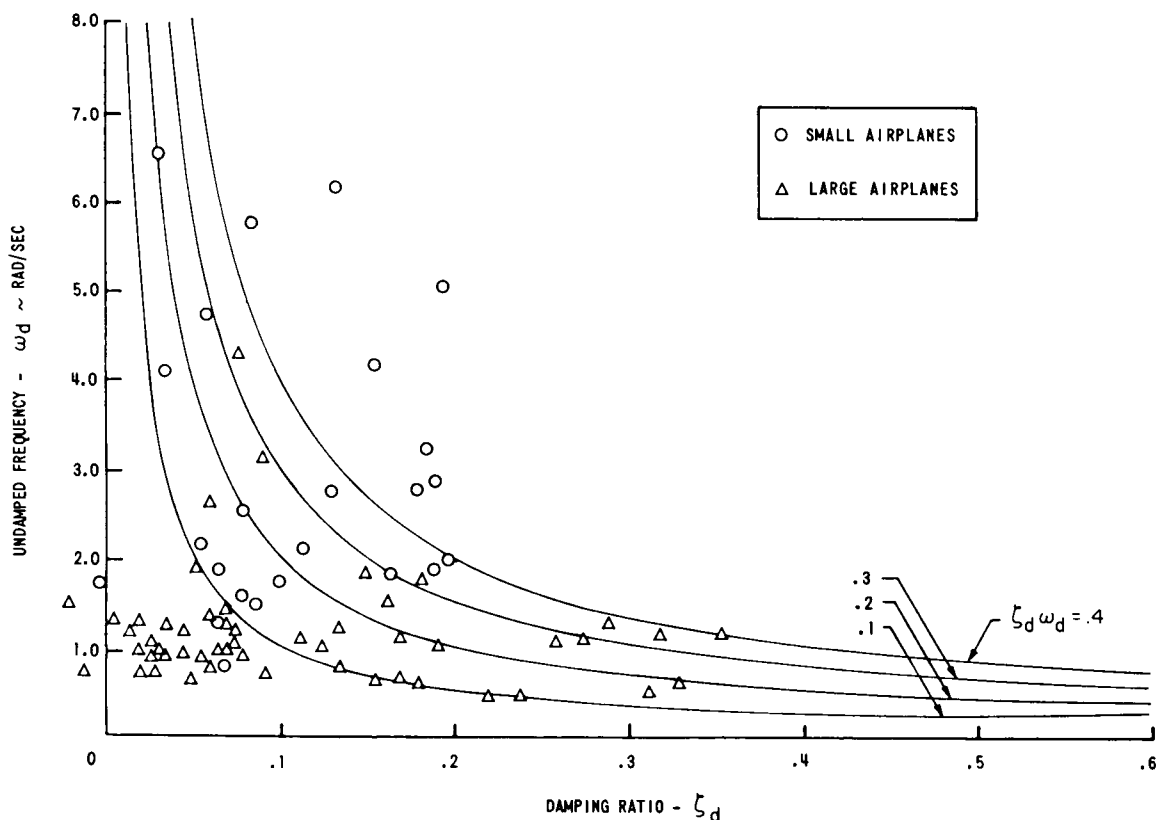
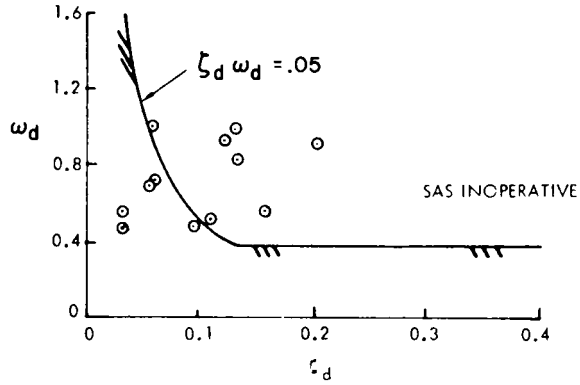

FIGURE 226. Dutch roll data on existing airplanes (from AGARD-CP-17).

Characteristics for the Lockheed C-5A, C-141A, YC-141B, and L-1011 (AFFDL-TR-78-171) are plotted on figure 227 for the Category B Flight Phase with yaw damper inoperative. The L-1011 meets the minimum requirements for Level 2 operation, while the C-5A, C-141A, and YC-141B all fail the Level 2 damping requirements. AFFDL-TR-78-171 discusses these results for the C-141A and C-5A:

MIL-STD-1797A
APPENDIX A

C-5A
CATEGORY B
LEVEL 2



C-141A & YC-141B
CATEGORY B
LEVEL 2

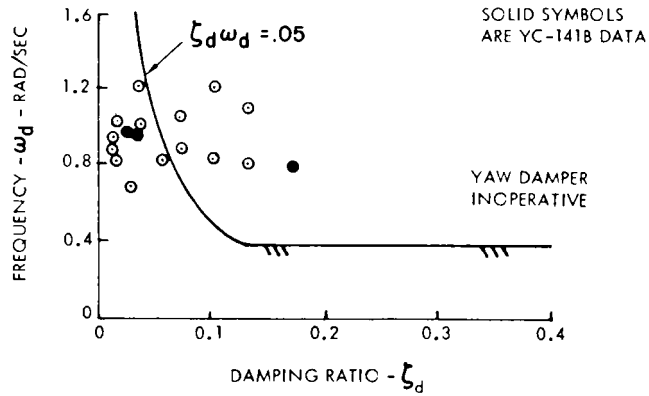

L-1011
CATEGORY B
LEVEL 2

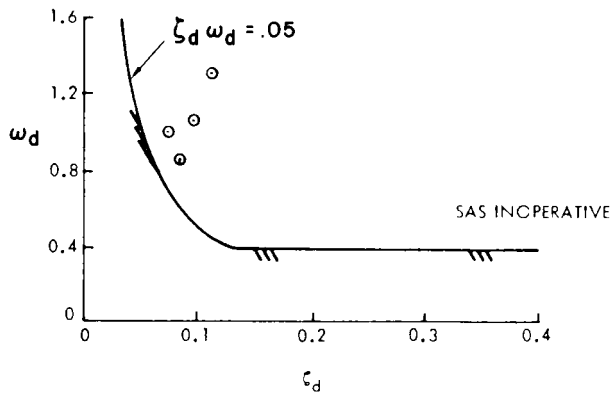

FIGURE 227. Lateral directional damping for some Class III airplanes (from AFFDL-TR-78-171).

MIL-STD-1797A
APPENDIX A

An evaluation of the C-141A dutch-roll recovery techniques with the yaw damper inoperative was conducted by the Air Force Flight Test Center in February 1977. Results of the tests ["C-141A Dutch Roll Recovery," AFFTC Technical Letter Report, by Picha and Klein] show Harper-Cooper rating values ranging from 2.0 to 5.0, using aileron only for recovery, which is the recommended Flight Handbook procedure. Over 100 dutch-roll maneuvers were accomplished during the evaluation, which consisted of regaining control of the aircraft and returning to a wings-level attitude from bank angles as high as 45 degrees. It should also be noted that evaluating pilots do not rate operation of the C-SA with the stability augmentation system off below [worse than] the suggested Level 2 guidelines (6.5 Harper-Cooper rating scale). These data strongly indicate that the Level 2 minimum $\zeta_d \omega_d$ requirement of 0.05 rad/sec is too stringent.

Comments by SPOs on the application of dutch roll requirements show the opposite trend: minimum allowable values of ζ_d have been increased for some current aircraft. Concern also was raised over applicability of the dutch roll requirements to augmented aircraft. The following table summarizes these comments for specific airplanes:

F-16	Parameters in this section are not easily applied to highly augmented aircraft.
F-15, F-16, C-141	ζ_d was increased to 0.30 for Category A.
AMST, B-1	Values for ζ_d were increased on AMST for Level 1 Category B and C (0.08 to 0.20) and Levels 2 and 3 (0.02 to 0.08); the minimum values of ω_d were also increased; a requirement that addresses higher dynamic modes that are present with augmentation needs to be defined.
A-10	Increased ζ_d above that required by MIL-F-8785B was the key to achieving good air-to-ground accuracy, as told in 3.2 Lessons Learned.

Considerations other than flying qualities may determine the acceptability of dutch roll characteristics: ride qualities in turbulence or in aileron rolls, or structural fatigue, for example.

5.6 Flying qualities requirements for the yaw axis-verification

5.6.1 Yaw axis response to yaw and side-force controllers-verification

5.6.1.1 Dynamic lateral-directional response-verification.

Verification shall be by analysis, simulation and flight test.

VERIFICATION RATIONALE(5.6.1.1)

It is intended that equivalent values of ζ_d and ω_d be used for augmented aircraft as well as those with simpler control systems. Inasmuch as there has been little work done to develop lower-order equivalent systems for the dutch roll response, guidance on this area is limited. To determine the equivalent ζ_d and ω_d , for cases where τ_e is small, simple measurements from a time response of sideslip to rudder kick will frequently be sufficient. A pair of sustained directional and lateral control pulses or doublets has been found to yield good identification without a large departure from trim. When $|\phi/\beta|_d$ is large, a significant portion of the dutch roll response occurs in roll, so that it may be desirable to match equivalent sideslip and roll responses simultaneously in order to best match pilots' impressions. Classical time response measures should be sufficient to extract ζ_d and ω_d from the sideslip time histories.

MIL-STD-1797A
APPENDIX A

VERIFICATION GUIDANCE

For most aircraft an appropriate lower-order equivalent system for sideslip response to a rudder input is adequate:

$$\frac{\beta}{F_{rp}} \doteq \frac{K_{\beta} e^{-\tau_{e\beta} s}}{s^2 + 2\zeta_d \omega_d s + \omega_d^2}$$

This is a simplification of the more complete three-degree-of-freedom classical form

$$\frac{\beta}{F_{rp}} = \frac{A_{\beta}(s + 1/T_{\beta_1})(s + 1/T_{\beta_2})(s + 1/T_{\beta_3})}{(s + 1/T_S)(s + 1/T_R)[s^2 + 2\zeta_d \omega_d s + \omega_d^2]}$$

where typically (but not necessarily) one zero is very large, one is small of the order of $1/T_S$ and the other is close to $1/T_R$ (see Aircraft Dynamics and Automatic Control). Approximations for ζ_d and ω_d are:

$$\omega_d^2 \doteq \frac{g}{C_{L_1} k_z^2 b} C'_{n_{\beta}}$$

$$2\zeta_d \omega_d \doteq -\frac{\rho V g}{2(W/S)} \left[C_{y_{\beta}} + \frac{1}{2k_z^2} C'_{n_r} - \frac{k_z^2}{k_x^2} \frac{C'_{\ell\beta}}{C'_{n_{\beta}}} \left(C_{L_1} - \frac{1}{2k_z^2} C'_{n_p} \right) \right]$$

$|\phi/\beta|_d$ is the ratio of amplitudes of the roll and sideslip envelopes in the dutch roll mode and $C_{L_1} = W/(\bar{q} S)$. The dutch-roll envelope of roll rate, p , is shown in figure 228 from AFFDL-TR-69-72, for a step command. Since the ratio is invariant with time, any suitable instant may be chosen.

Compliance must be demonstrated through flight testing at the minimum and maximum specified operational altitudes, over the range of service airspeeds, with the aircraft configured for maximum yawing moment of inertia to get the lowest ω_d .

Factors affecting the stability derivatives include: angle of attack, Mach number, and aerodynamic pressure. Aerodynamic directional stability may deteriorate noticeably as the c.g. moves aft.

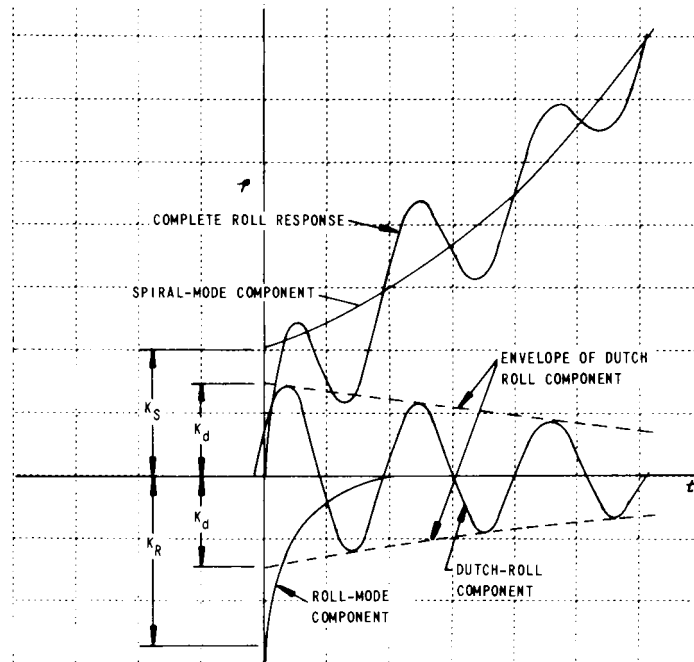

FIGURE 228. Finding the dutch roll envelope.

VERIFICATION LESSONS LEARNED

MIL-STD-1797A
APPENDIX A

4.6.1.2 Steady sideslips.

The long-term response to yaw-control-pedal deflections shall have the following characteristics: _____ . This requirement applies to yaw-and-roll-control-induced steady, upright, zero-yaw-rate sideslips with the aircraft trimmed for wings-level straight flight, at sideslip angles up to those produced or limited by:

- a. Full yaw-control-pedal deflection, or
- b. 250 pounds of yaw-control-pedal force, or
- c. Maximum roll control or surface deflection,

except that for single-propeller-driven aircraft during waveoff (go-around), yaw-control-pedal deflection in the direction opposite to that required for wings-level straight flight need not be considered beyond the deflection for a 10 deg change in sideslip from the wings-level straight flight condition.

Right yaw-control-pedal force and deflection shall produce left sideslips, and left yaw-control-pedal force and deflection shall produce right sideslips. For Levels 1 and 2 the following requirements shall apply. The variation of sideslip angle with yaw-control-pedal deflection shall be essentially linear for sideslip angles between _____ and _____ degrees. The variation of sideslip angle with yaw-control-pedal force shall be essentially linear for sideslip angles between _____ degrees and _____ degrees. For larger sideslip angles, an increase in yaw-control-pedal force shall always be required for an increase in sideslip.

REQUIREMENT RATIONALE(4.6.1.2)

This requirement is intended to provide static directional stability for reasonable sideslip angles, and to prevent rudder lock at any possible rudder deflection.

REQUIREMENT GUIDANCE

The related MIL-F-8785C requirements are paragraphs 3.3.6 and 3.3.6-1.

Recommended sideslip angle ranges are ± 15 deg for β/δ_{rp} , ± 10 deg for β/F_{rp} . Essentially linear, it should be noted, is qualitative rather than absolute.

This requirement regulates against the classical rudder lock problem with unpowered controls, wherein pedal force reverses at large sideslip angles (see Perkins and Hage, "Airplane Performance Stability and Control"). Controls-free static directional stability for small sideslip angles is implied by the 4.6.1.1 requirement that ω_d be greater than zero -- except that a favorable product-of-inertia effect can make up dynamically for a certain amount of static instability. However, generally verification of the dynamic requirement is limited to small or moderate sideslip angles. Although meeting the static stability requirement does not necessarily assure dynamic stability, it does tend to promote it while at least insuring against an unnatural steady-state response.

The recommended requirements are very straightforward in interpretation and application. It is sensible to insure static stability over the given range, which may go beyond the range of sideslips in normal operation (but that still might reasonably be encountered occasionally), and that the response to yaw controls not be unnatural. A requirement for positive rudder deflection gradients with β provides a cue to the pilot of increasing sideslip in normal operations. Rudder lock in larger sideslips, which creates difficulty in recovering, is prohibited. Rudder lock results from a reversal of rudder floating tendency (with unpowered controls) at large sideslip angles; a dorsal fin is a useful fix. See, e.g., Airplane Performance Stability and Control.

A complementary roll-axis requirement will be found in 4.5.5.

MIL-STD-1797A
APPENDIX A

REQUIREMENT LESSONS LEARNED

5.6.1.2 Steady sideslips-verification.

Verification shall be by analysis, simulation and flight test.

VERIFICATION RATIONALE(S.6.1.2)

In order to totally remove the effects of aerodynamic damping from this static stability requirement, the requirement is stated for straight flight, with no yawing. Therefore, generally in the sideslips the wings will not be level. Thus there may be some small but probably insignificant difference from the wings-level sideslips specified by the FARs. Measurements should cover rudder deflections from zero to maximum (which may be a function of flap deflection or landing gear position, dynamic pressure, etc.) and any differences between right and left sideslips need to be determined.

VERIFICATION GUIDANCE

The most critical trimmed flight condition will be at the most aft center of gravity with any destabilizing external stores. Test conditions should cover the service speed range at the minimum, intermediate, and maximum operational altitudes.

Over the sideslip range for linear aerodynamics,

$$\frac{d\delta_r}{d\beta} = -\frac{C_{n_\beta}}{C_{n_{\delta_r}}} \left(\frac{1 - \frac{C_{n_{\delta_a}} C_{\ell_\beta}}{C_{\ell_{\delta_a}} C_{n_\beta}}}{1 - \frac{C_{n_{\delta_a}} C_{\ell_{\delta_r}}}{C_{\ell_{\delta_a}} C_{n_{\delta_r}}}} \right)$$

$$\frac{d\delta_a}{d\beta} = -\frac{C_{\ell_\beta} - C_{n_\beta} C_{\ell_{\delta_r}} / C_{n_{\delta_r}}}{C_{\ell_{\delta_a}} \left(1 - \frac{C_{n_{\delta_a}} C_{\ell_{\delta_r}}}{C_{\ell_{\delta_a}} C_{n_{\delta_r}}} \right)}$$

$$\frac{d\phi}{d\beta} = -\frac{C_{y_\beta}}{C_{L_1}} \left[1 - \frac{C_{y_{\delta_r}} C_{n_\beta}}{C_{n_{\delta_r}} C_{y_\beta}} \left(\frac{1 - \frac{C_{n_{\delta_a}} C_{\ell_\beta}}{C_{\ell_{\delta_a}} C_{n_\beta}}}{1 - \frac{C_{n_{\delta_a}} C_{\ell_{\delta_r}}}{C_{\ell_{\delta_a}} C_{n_{\delta_r}}}} \right) - \frac{C_{y_{\delta_a}} (C_{\ell_\beta} - C_{n_\beta} C_{\ell_{\delta_r}} / C_{n_{\delta_r}})}{C_{\ell_{\delta_a}} C_{y_\beta} \left(1 - \frac{C_{n_{\delta_a}} C_{\ell_{\delta_r}}}{C_{\ell_{\delta_a}} C_{n_{\delta_r}}} \right)} \right]$$

Modified "effective" derivatives can account for crossfeeds and simple feedbacks which are not washed out. As an example, with lateral acceleration feedback to the rudder, the commanded rudder deflection ($\delta_r = \delta_{rc} + a_y \cdot \partial\delta_r / \partial a_y$) is

MIL-STD-1797A
APPENDIX A

$$\frac{d\delta_{rc}}{d\beta} = -\frac{C_{n\beta}}{C_{n\delta_r}} \left[1 - \frac{C_{n\delta_a} C_{\ell\beta}}{C_{\ell\delta_a} C_{n\beta}} \right] + \frac{\partial\delta_r}{\partial a_y} \cdot \frac{g}{C_{L_1}} C_{n\delta_r} \left[\frac{C_{y\beta}}{C_{n\beta}} - \frac{C_{y\delta_r}}{C_{n\delta_r}} \left(1 - \frac{C_{n\delta_a} C_{\ell\beta}}{C_{\ell\delta_a} C_{n\beta}} \right) \right]$$

Since $C_{L_1} = (W/S)/\bar{q}$, a given a_y feedback gain is higher at high speed, lower at low speed in terms of β .

VERIFICATION LESSONS LEARNED

MIL-STD-1797A
APPENDIX A

4.6.1.3 Wings-level turn.

For a wings-level-turn mode of control, the following requirements apply:

a. Dynamic response to direct force control (DFC) input: The bandwidth of the open-loop response of heading or lateral flight path angle to the DFC input shall be greater than _____ for Flight Phase _____. Turns shall occur at approximately zero sideslip angle and zero or constant small bank angle when using the DFC controller.

b. Steady-state response to direct force control input: Maximum DFC inputs shall produce at least _____.

c. Direct force control forces and deflections: Use of the primary DFC shall not require use of another control manipulator to meet the above dynamic response requirement. The controller characteristics shall meet the following requirements: _____.

d. Crew acceleration: Abrupt, large DFC inputs shall not produce pilot head or arm motions which interfere with task performance. Crew restraints shall not obstruct the crew's normal field of view nor interfere with manipulation of any cockpit control required for task performance.

REQUIREMENT RATIONALE

This requirement is included to specify the response characteristics of aircraft utilizing an extra DFC mode for wings-level turns. This mode, allowing changes in heading to occur at zero bank angle, is sometimes referred to as the "A_y" mode (see, for example, AIAA Paper 77-1119); a sketch of the aircraft motions and a summary of the useful features is given below:

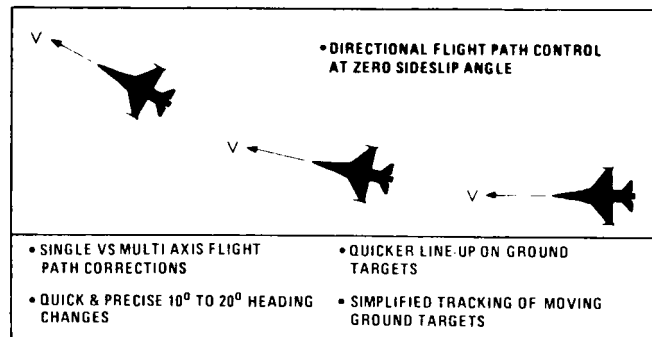

REQUIREMENT GUIDANCE

The related MIL-F-8785C requirement is paragraph 3.4.11.

Recommended values (Part a): The recommended values of required bandwidth depend on the piloting task associated with certain missions and mission phases as shown in table XLI.

The parameters subject to the bandwidth limitation in table XLI are given in table XLII.

MIL-STD-1797A
APPENDIX A

TABLE XLI. Recommended bandwidth limits for wings-level turn mode.

TASK	REQUIRED BANDWIDTH (rad/sec)	
	LEVEL 1	LEVEL 2
Tracking (Cat. A) Air-to-air gunnery Strafing Dive bombing	1.25	0.60
Path Deviation (Cat. A, C) Formation Air-to-air refueling Approach	0.30	0.12

TABLE XLII. Aircraft parameters subject to bandwidth limitation for wings-level turn mode.

TASK	CONTROL VARIABLE
Air-to-air tracking	Heading angle if sideslip is not an important factor for weapon release Lateral path angle if sideslip must be small for weapon release
Air-to-ground tracking Pointing tasks Strafing Flight path tasks Dive bombing	Heading angle Lateral path angle, or lateral velocity

Recommended values (Part b) to be determined by analysis, ground and in-flight simulation based upon task requirements. Recommended values (Part c): When the rudder pedals are to be used as the direct force controller, the requirements of 4.6.7 may be used as a guide. If a special-purpose controller such as a thumb switch or lever is to be used, acceptable characteristics should be determined in flight test.

The bandwidth criterion used in this requirement makes the fundamental assumption that the primary factor in the pilot's evaluation of a DFC mode is his ability to exert tight control to minimize errors and thereby improve closed-loop tracking performance. The criterion originates from an old, well-accepted idea -- that a measure of the handling qualities of an aircraft is its response characteristics when

MIL-STD-1797A APPENDIX A

operated in a closed-loop compensatory tracking task.

The bandwidth (ω_{BW}) is a measure of the maximum frequency at which such closed-loop tracking can take place without requiring the pilot to supply favorable dynamic compensation and without threatening stability. It follows that aircraft capable of operating at a large value of bandwidth will have superior performance, readily achieved. An implicit characteristic of the requirement is that inter-axis coupling or contamination, regardless of type or source, affects the pilot opinion only insofar as it affects the bandwidth. This is a highly desirable feature of the requirement because the very large varieties of coupling that can occur would make it virtually impossible to classify and set limits on each type of coupling.

The bandwidth criterion was also used to set limits on pitch attitude dynamics in 4.2.1.2.

For additional background on the use of bandwidth as a criterion for DFC modes the reader is referred to AFWAL-TR-81-3127, AFFDL-TR-76-78, and AFFDL-TR-78-9.

Definition of Bandwidth

The bandwidth frequency, ω_{BW} , to be used in table XLI is defined from the frequency response plot of heading or lateral flight-path angle to cockpit direct-force control input (i.e., χ/F_{DFC} or ψ/F_{DFC}). Specifically, it is the lower of two frequencies: the frequency at which the phase margin is 45 deg, or the frequency for a gain margin of 6 dB (figure 229). In order to apply this definition, first determine the frequency for neutral closed-loop stability (180 deg phase angle) from the phase portion of the Bode plot (ω_{180}). The next step is to note the frequency at which the phase margin is 45 deg. This is the bandwidth frequency defined by phase, $\omega_{BW\text{phase}}$. Then, note the amplitude corresponding to ω_{180} and add 6 dB to it. The frequency at which this value occurs on the amplitude curve is $\omega_{BW\text{gain}}$. Finally, the bandwidth, ω_{BW} , is the lesser of $\omega_{BW\text{phase}}$ and $\omega_{BW\text{gain}}$.

If $\omega_{BW} = \omega_{BW\text{phase}}$, the system is said to be phase-margin limited. On the other hand, if $\omega_{BW} = \omega_{BW\text{gain}}$ the system is gain-margin limited; that is, the aircraft is driven to neutral stability when the pilot increases his gain by 6 dB (a factor of 2). Gain-margin-limited aircraft may have a great deal of phase margin, Φ_M , but then increasing the gain slightly causes Φ_M to decrease rapidly. Such systems are characterized by frequency-response amplitude plots that are flat, combined with phase plots that roll off rapidly, such as shown on figure 229.

Control Sensitivity

Some guidance regarding DFC sensitivity may be found in AFWAL-TR-81-3027 flight tests of the wings-level turn mode. The in-flight simulator was set up so that DFC sensitivity could be varied. The pilots were asked to vary the control sensitivity of each new configuration to determine the optimum value, thereby eliminating it as a variable in the problem. It was found that the pilot ratings were not dependent on small variations in control sensitivity for either uncoupled or adversely coupled configurations.

The acceptability of configurations with large values of favorable yaw or roll coupling tended to be significantly more dependent on control sensitivity. This is shown by comparing figure 231 for high favorable yaw coupling and figure 232 for very high favorable roll coupling with figure 230 for low coupling. It is interesting to note that the nominal value of control sensitivity used with low coupling (0.008 g/lb) was found to be unacceptably high for the favorable coupling cases. The scatter in the data shown on figure 232 is primarily due to pilot MP. In order to help explain why MP's ratings are higher, his comments have been annotated near the appropriate data points on figure 232. It is clear that his poor ratings are based on his fundamental objection to utilizing roll coupling to improve tracking bandwidth, although his comments for the lowest-sensitivity case indicate that adequate performance could be obtained in this mode.

MIL-STD-1797A
APPENDIX A

Bandwidth is the lesser of two frequencies $\omega_{BW_{phase}}$ and $\omega_{BW_{gain}}$

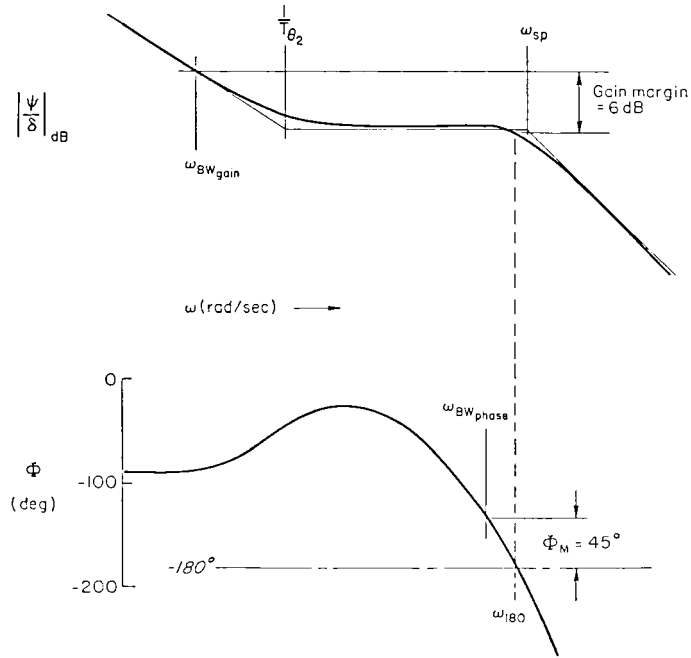

FIGURE 229. Definition of bandwidth frequency.

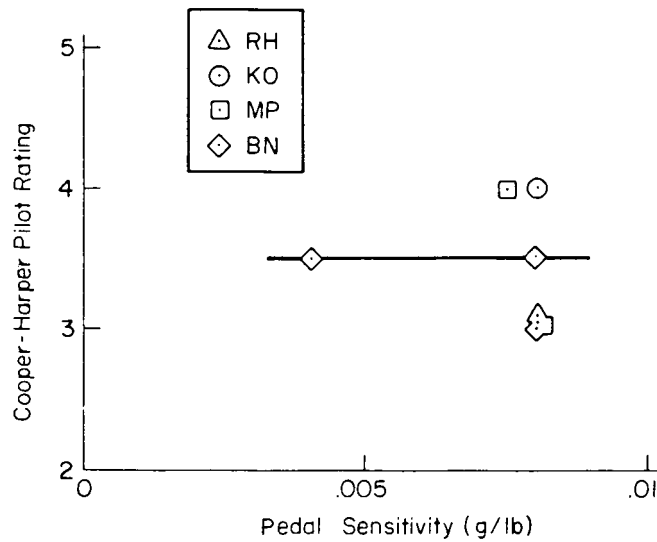

FIGURE 230. Effect of DFC manipulator sensitivity configuration WLT1 (very low coupling) (from AFWAL-TR-81-3027).

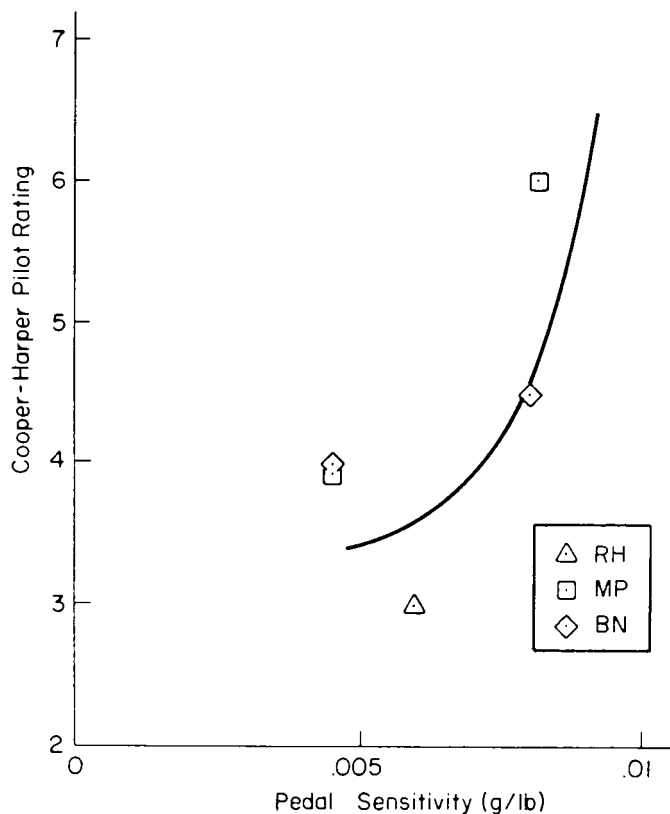

FIGURE 231. Effect of DFC manipulator sensitivity configuration WLT5 (high favorable yaw coupling) (from AFWAL-TR-81-3027).

One interpretation is that pilot MP's rating of 5 was given to discourage intentional design of proverse roll coupling to improve tracking bandwidth. Hence, even though large values of favorable roll coupling may be inferred as acceptable to produce Level 1 flying qualities, the designer is cautioned against using such coupling to overcome an inherently low bandwidth. This is especially pertinent for configurations having a cockpit farther from the roll axis (than in the Navion) and therefore subjecting the pilot to more roll-induced lateral acceleration.

SUPPORTING DATA

The variable-stability flight test experiment of AFWAL-TR-81-3027 provides supporting data, for both limiting values of bandwidth and validity of bandwidth as a criterion for DFC modes.

The Cooper-Harper pilot ratings from the AFWAL-TR-81-3027 experiment are plotted versus heading bandwidth on figure 233 for the air-to-air tracking task using the wings-level turn mode. The open symbols on figure 233 indicate that variations in heading bandwidth were achieved via yaw coupling. That is, the crossfeed gain from DFC control (pedal) to the rudder was increased above its nominal value to achieve favorable yaw coupling and reduced below its nominal value to achieve unfavorable yaw coupling. For solid symbols on figure 233 the heading bandwidth was varied via changes in roll coupling, i.e., the DFC to aileron gain.

MIL-STD-1797A
APPENDIX A

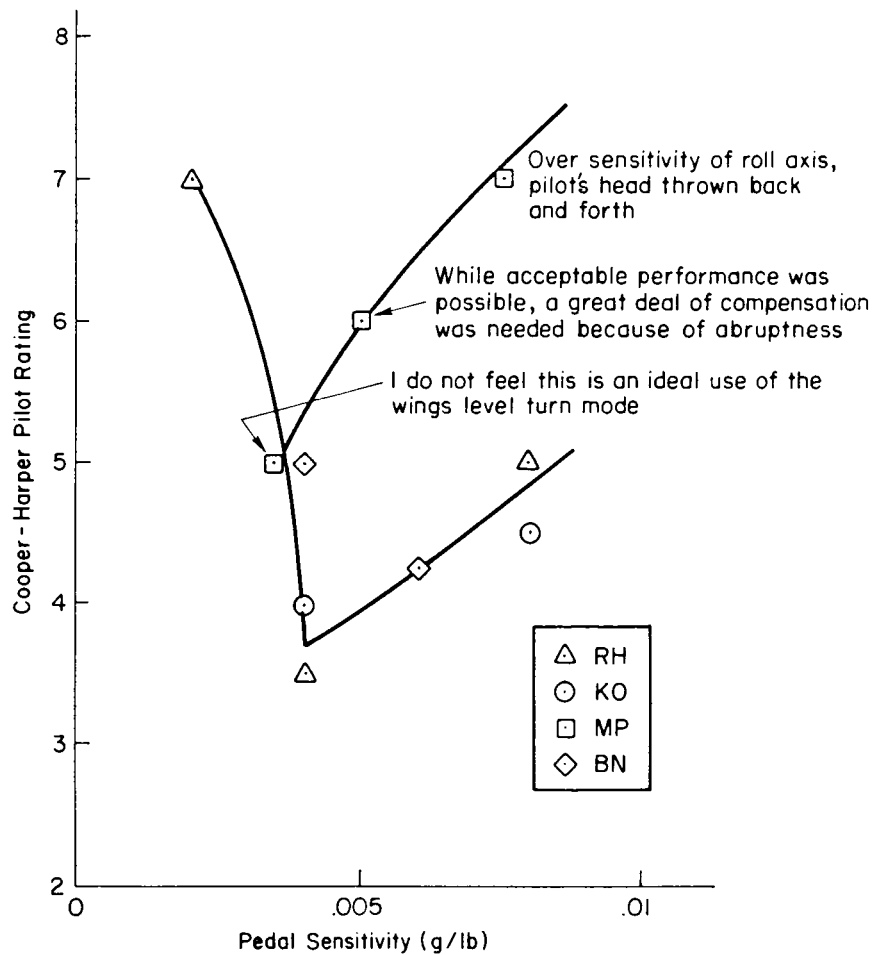

FIGURE 232. Effect of DFC manipulator sensitivity -- configuration WLT12 (very high favorable roll coupling) (from AFWAL-TR-81-3027).

To the pilot, favorable yaw coupling appears as a tendency for the nose to move abruptly in the direction of the commanded turn, whereas unfavorable yaw coupling is a tendency for the nose initially to swing away from the commanded turn. When flying a configuration with favorable roll coupling, the pilot will observe a tendency for the aircraft to roll in the direction of the commanded wings-level turn, thereby augmenting the yaw response (provided roll is not too large). Finally, adverse roll coupling is a tendency for the aircraft to bank away from the commanded wings-level turn. The validity of bandwidth as a criterion for DFC is supported by the following observations from figure 233:

The pilot ratings for Configurations WLT4 and WLT15 (adverse yaw coupling) are approximately the same as the pilot rating for Configuration WLT13 (adverse roll coupling). As can be seen from figure 233, all of these configurations have approximately the same heading bandwidth of between 0.7 and 0.8 rad/sec.

Configuration WLT3 (slight adverse yaw coupling) has approximately the same pilot rating as Configuration WLT14 (slight adverse roll coupling). The bandwidths of these configurations are both approximately 1.1 rad/sec.

MIL-STD-1797A
APPENDIX A

Configurations WLT10 and WLT12 have significant favorable roll coupling and correspondingly high values of heading bandwidth. Configuration WLT5 also has a large value of heading bandwidth (4.10 rad/sec) by virtue of its highly proverse yaw coupling. Figure 233 indicates that these configurations are all rated approximately the same.

The above examples provide strong evidence to indicate that satisfactory wings-level turn flying qualities depend primarily on the ability of the pilot to increase his tracking bandwidth to some established level by tightening up on the controls.

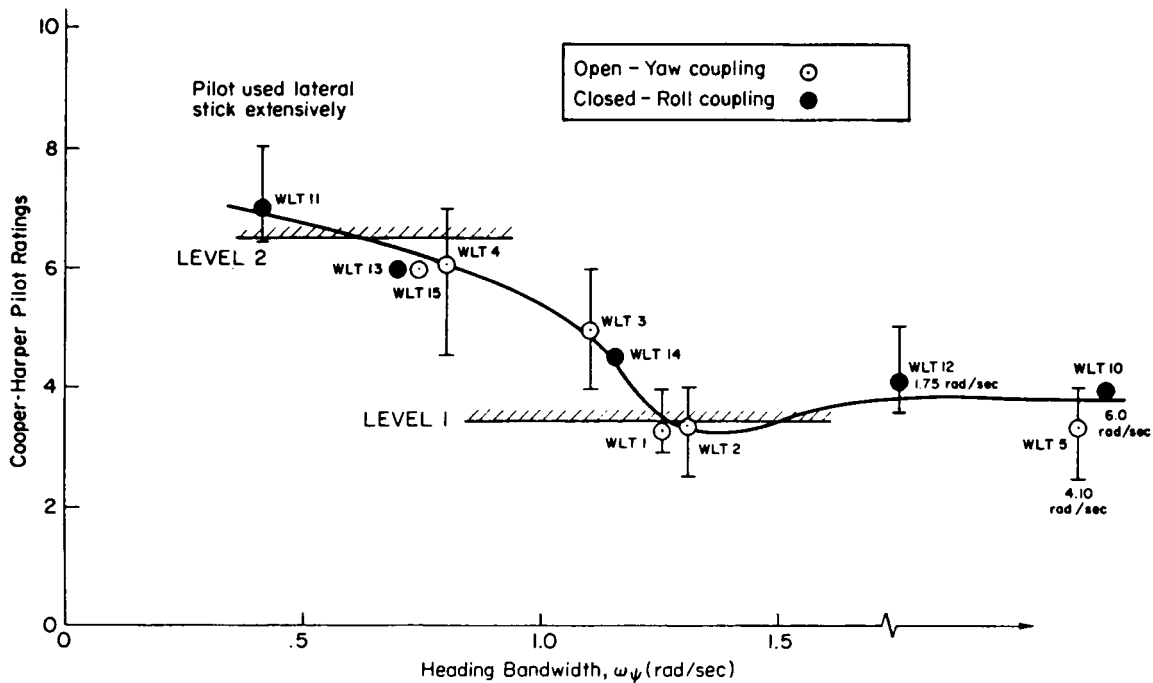

FIGURE 233. Correlation of pilot ratings with heading bandwidth; wings-level turn mode; air-to-air tracking task.

The variable-stability aircraft was a Princeton University Navion, which has an operational speed of 105 kt. This resulted in lateral accelerations that were a factor of 5 lower than would occur at typical air combat speeds. However, recent AFAMRL centrifuge data (Investigation of the Effects of g_y and g_z on AFTI/F-16 Control Inputs, Restraints, and Tracking Performance) indicate that pilots can track in a lateral acceleration environment of 2.5 g when properly constrained; whereas the Navion was limited to 0.5 g, had no side restraint.

The rating data on figure 233 indicate that even the best wings-level turn configurations barely meet the classical definition of Level 1 flying qualities (e.g., Cooper-Harper pilot rating equal to or better than 3-1/2). However, when one considers that the task involves tracking a target undergoing large and rapid bank angle reversals, it is difficult to conceive of any configuration that would correspond to the adjectival descriptions of a pilot rating of 3 (i.e., "minimal pilot compensation required for desired performance"). The pilot commentary in AFWAL-TR-81-3027 indicates that the WLT1 configuration had very acceptable flying qualities and that the desired performance in tracking was easily attained (but apparently involved more than minimal compensation). Hence, the inability to attain average pilot ratings better than 3 is felt to be attributable not to the configuration but rather to the difficulty of the task involved. Pilot ratings of 2 for the wings-level turn mode were obtained in AIAA-80-1628-CP. The tracking task in that case was a

MIL-STD-1797A
APPENDIX A

ground target that performed a discrete step change in position, a significantly less demanding task than the air-to-air tracking utilized in AFWAL-TR-81-3027.

The use of secondary controls was allowed in AFWAL-TR-81-3027. That is, the pilots were specifically instructed to utilize the centerstick to improve tracking if such control techniques seemed warranted. This was done for consistency with the real-world situation in which pilots might well use the wings-level turn mode for fine tuning and the basic aircraft controls for gross maneuvering. Such control usage was found to conform to the normal pilot-centered requirements for separation of controls, i.e., only one control can be utilized at the primary closed-loop frequency, with all other controls limited to performing trimming-like functions. In the AFWAL-TR-81-3027 experiments, the pilots utilized the centerstick any time the target bank angle appeared excessively large so that the DFC side force generators were approaching their limit. Such low-frequency secondary control usage was found to be entirely acceptable. However, attempts to utilize the secondary control to improve the tracking bandwidth of the primary DFC were unsuccessful.

The bandwidth requirements stated for the path deviation task (Cat. C in table XLI) are based on the lateral translation mode results given in AFWAL-TR-81-3027, as well as heading control results obtained for conventional aircraft in previous programs. An example of such results is shown on figure 234, taken from NASA-CR-2017. Figure 234 indicates that most points below a heading bandwidth of 0.3 rad/sec are Level 2 or worse. For lack of any better data, the Level 2 boundary was defined (from figure 234) as 0.12 rad/sec.

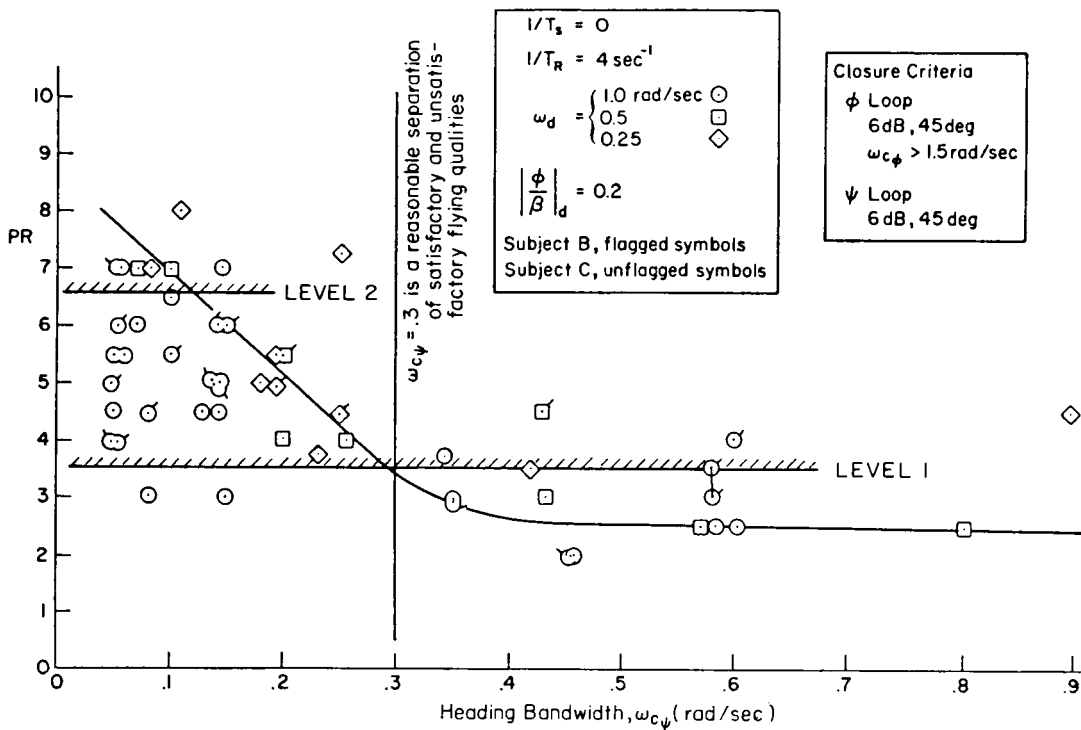

FIGURE 234. Correlation of pilot ratings with heading bandwidth for conventional aircraft; ILS approach task.

Part (b) of the requirement relates to the turn rate or lateral acceleration necessary to accomplish the desired task. AFFDL-TR-76-78 indicated that 1 lateral g was sufficient for air-to-ground and AFWAL-TR-81-3027 indicated that 2.5 lateral g would be required for air combat maneuvering. Obviously, some form of lateral pilot restraint will be required. As mentioned previously, recent results from the AFAMRL

MIL-STD-1797A
APPENDIX A

centrifuge (Investigation of the Effects of g_y and g_z on AFTI/F-16 Control Inputs, Restraints and Tracking Performance) have indicated that a restrained pilot can track up to about 2.5 lateral g. At this time, however, the operational usefulness of such large lateral acceleration has not been established.

"Criteria for Side Force Control in Air-to-Ground Target Acquisition and Tracking", elaborating on the NASA Ames FSAA results of NASA TM 81266 and AIAA Paper 80-1628-CP for a dive-bombing task, recommends a bandwidth of at least 2.3 rad/sec for a Level 1 wings-level turn mode, almost double the AFWAL-TR-81-3027 recommendation adopted here. Different tasks, simulators and pilots may have contributed to this difference in results.

REQUIREMENT LESSONS LEARNED

The F-16 CCV utilized a wings-level turn mode (AIAA Paper 77-1119) with considerable success. Pilots found the mode particularly useful for air-to-ground missions. The aircraft was capable of approximately 0.8 g, and at least one pilot reported that this would not be excessive providing adequate lateral pilot restraints could be provided. Two DFC controllers were tried: the conventional rudder pedals and a CCV thumb button. The rudder pedals were the favored controller (see AFFDL-TR-78-9).

When mechanizing a wings-level turn mode, consideration should be given to the impact of the particular mechanization on aircraft flying qualities and performance degradation. A large drag rise can occur when deflecting aerodynamic surfaces to generate the wings-level turn causing a rapid airspeed bleedoff. The loss of aircraft velocity may offset any tactical advantage gained from using the mode.

5.6.1.3 Wings-level turn -verification.

Verification shall be by analysis, simulation and flight test.

VERIFICATION RATIONALE(5.6.1.3)

Compliance with Part (d) can only be determined in flight test, since the necessary combination of visual and lateral acceleration cues cannot be obtained in a ground-based simulator.

VERIFICATION GUIDANCE

The lateral acceleration produced by a given DFC deflection will vary with dynamic pressure, \bar{q} .

A discussion of Fast Fourier Transform procedures that can be used to generate frequency response (Bode) plots from flight test or simulator data is given in 5.2.1.2 guidance. Once the Bode plots of heading or lateral flight path angle to DFC input are obtained it is a simple matter to determine the bandwidth as shown in figure 235.

VERIFICATION LESSONS LEARNED

MIL-STD-1797A
APPENDIX A

4.6.2 Yaw axis response to roll controller.

The sideslip excursions to step roll control inputs shall meet the following criteria: _____. Yaw controls shall be free and, in initial steady turns, fixed at the deflection for zero sideslip in the turn.

REQUIREMENT RATIONALE (4.6.2)

This requirement is intended to insure that any yaw control needed to coordinate turn entries and recoveries/reversals is not objectionable to the pilot. Alternative requirements use the value of sideslip angle that accompanies roll control inputs as the measure of acceptance or place limits directly on the rudder pedal required for turn coordination.

REQUIREMENT GUIDANCE

The related MIL-F-8785C requirements are paragraphs 3.3.2.4 and 3.3.2.4.1.

The requirements presented apply to sideslip excursions. Other related motions of interest, but on which we cannot now lay any requirements, are lateral acceleration (at the pilot station) and the initial yawing response.

The rationale for zero sideslip is given in footnote 12, Guidance for 4.6.2.

COORDINATION IN TURN ENTRY AND EXIT: ALTERNATIVE 1

a. The amount of sideslip following a small step roll control command shall be within the limits shown in figure 235 for Levels 1 and 2. This requirement applies for step roll control commands up to the magnitude that causes a 60 degree bank angle change within T_d or 2 seconds, whichever is longer.

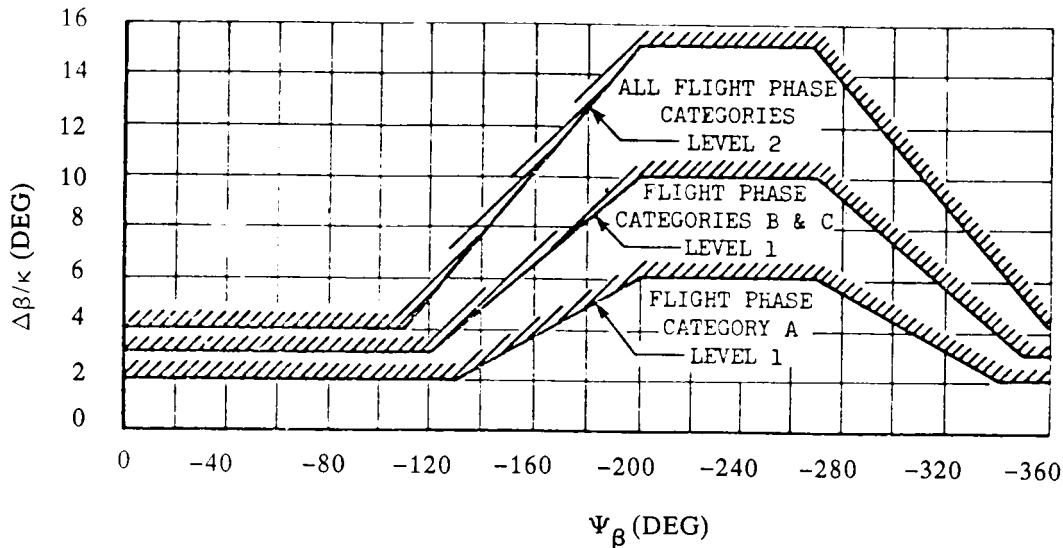

FIGURE 235. Sideslip excursion limitations for small roll control commands.

b. Following larger step roll control commands, the ratio of the sideslip increment, $\Delta\beta$, to the parameter k (3.4.6) should be less than the values specified in table XLIII. The roll command shall be held fixed until the bank angle has changed at least 90 degrees.

MIL-STD-1797A
APPENDIX A

TABLE XLIII. Recommended maximum sideslip excursions for large roll control commands.

LEVEL	FLIGHT PHASE CATEGORY	ADVERSE SIDESLIP (RIGHT ROLL COMMAND CAUSES RIGHT SIDESLIP)	PROVERSE SIDESLIP (LEFT ROLL COMMAND CAUSES RIGHT SIDESLIP)
1	A	6 degrees	2 degrees
	B and C	10 degrees	3 degrees
2	All	15 degrees	4 degrees

This requirement was first introduced in MIL-F-8785B. The following discussion is reprinted from AFFDL-TR-69-72.

The primary source of data from which the sideslip requirement evolved is the low $|\phi/\beta|_d$ (= 1-5) configurations of AFFDL-TR-67-98 (figure 236). Analysis of the data revealed that the amount of sideslip that a pilot will accept or tolerate is a strong function of the phase angle of the dutch roll component of sideslip. When the phase angle is such that β is primarily adverse (out of the turn which is being rolled into), the pilot can tolerate quite a bit of sideslip. On the other hand, when the phasing is such that β is primarily proverse (into the turn), the pilot can only tolerate a small amount of sideslip because of difficulty of coordination.

There is more to coordination, however, than whether the sideslip is adverse or proverse: the source and phasing of the disturbing yawing moment also significantly affect the coordination problem. If the yawing moment is caused by aileron and is in the adverse sense, then in order to coordinate the pilot must phase either right rudder with right aileron or left rudder with left aileron. Since pilots find this technique natural they can generally coordinate well even if the yawing moment is large. If, on the other hand, the yawing moment is in the proverse sense or is caused by roll rate, coordination is far more difficult. For proverse yaw due to aileron the pilot must cross control; and for either adverse or proverse yaw due to roll rate, required rudder inputs must be proportional to roll rate and also phased with respect to it. Pilots find these techniques unnatural and difficult to perform. Since yawing moments may also be introduced by yaw rate, it can be seen that depending on the magnitude and sense of the various yawing moments, coordination may be either easy or extremely difficult. If coordination is sufficiently difficult that pilots cannot be expected to coordinate routinely, the flying qualities requirements must restrict unwanted motions to a size acceptable to pilots.

Analysis further revealed that it was not so much the absolute magnitude of the sideslip that bothered the pilot, but rather the maximum change in sideslip. The latter was a better measure of the amount of coordination required. Thus, the data from this program were plotted on figure 237 as the maximum change in sideslip occurring during a rudder-pedals-fixed rolling maneuver, $\Delta\beta$, versus the phase angle of the dutch roll component of the sideslip, (Note that the dutch roll damping ratio is Level 2 for the data of figure 237.)

The phase angle ψ_β , is a measure of the sense of the initial sideslip response, whether adverse or proverse, while $\Delta\beta$ is a measure of the amplitude of the sideslip generated. Both the sense and the amplitude affect the coordination problem.

MIL-STD-1797A
APPENDIX A

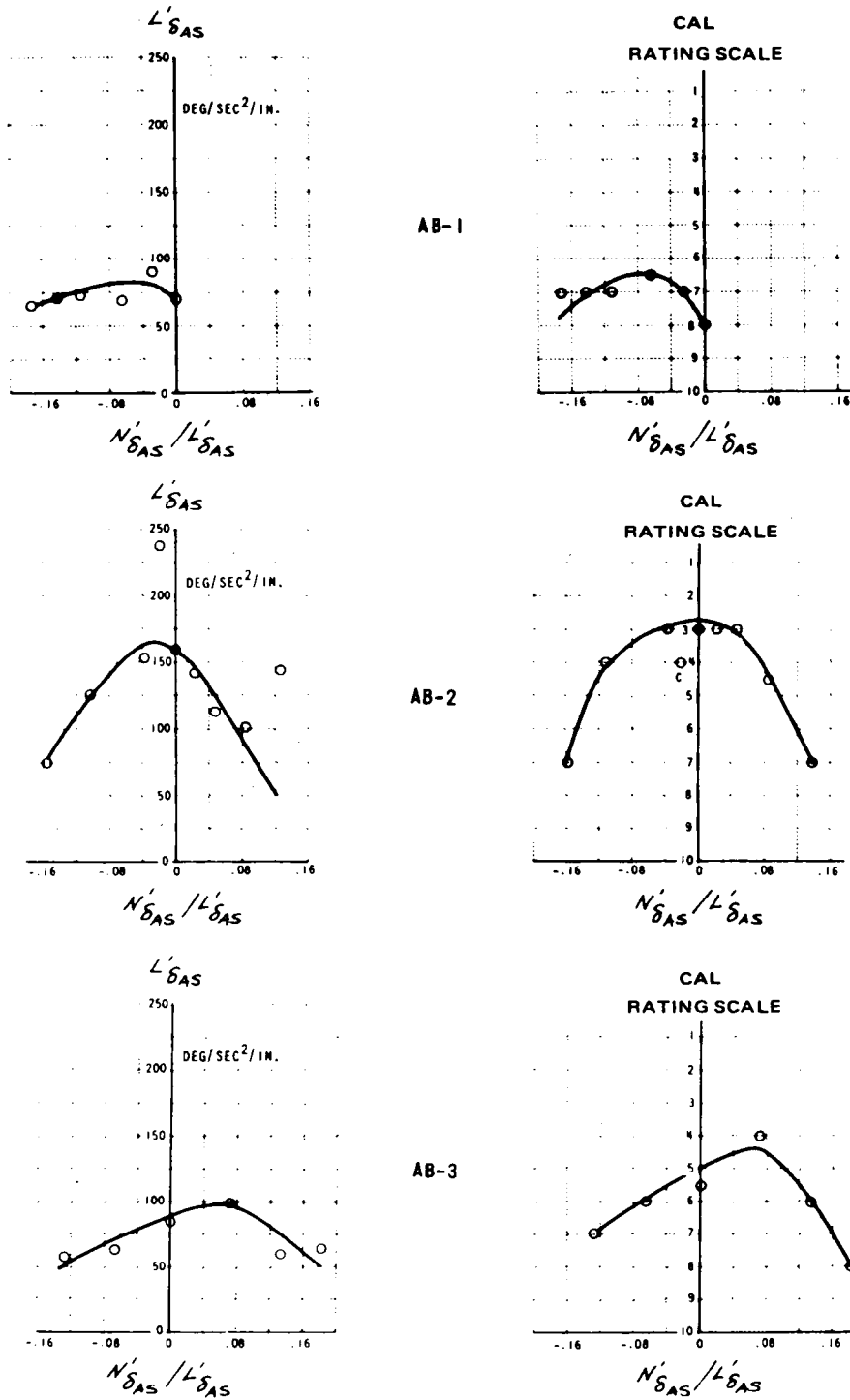

FIGURE 236. Pilot ratings and optimum aileron sensitivity (low $|\phi/\beta|_d$, medium T_R) (AFFDL-TR-67-98).

MIL-STD-1797A
APPENDIX A

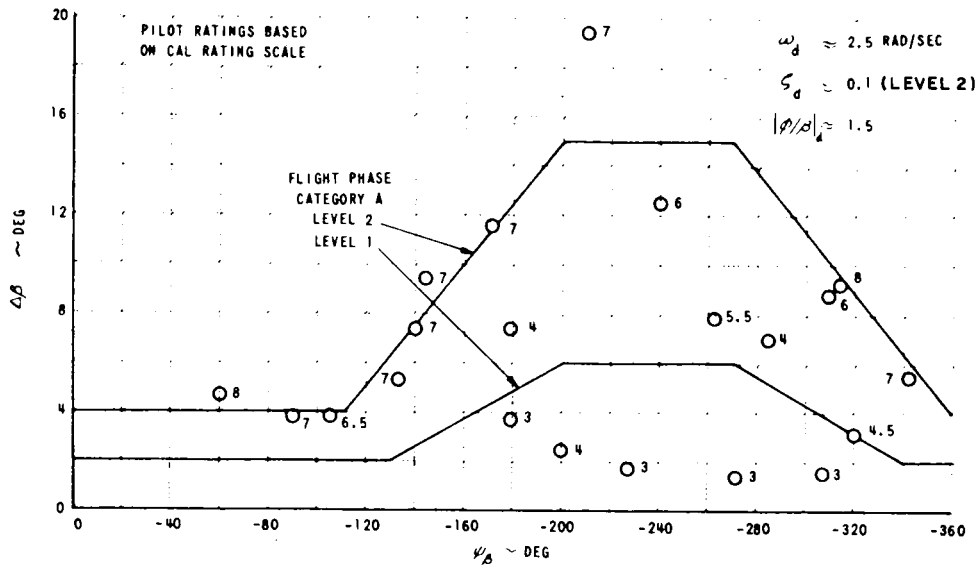
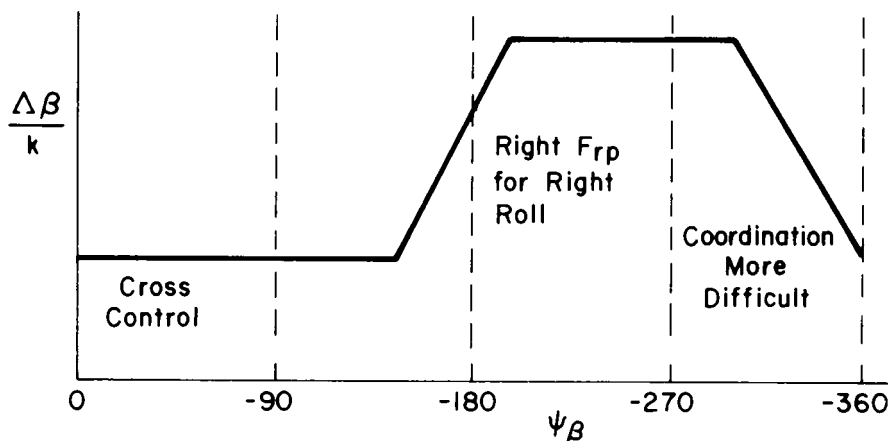

FIGURE 237. Flight Phase Category A data from AFFDL-TR-67-98.

It was observed from examination of the low $|\phi/\beta|_d$ data plotted on figure 237 that the break points in curves of iso-pilot ratings occurred at almost exactly the same values of ψ_β as for the moderate $|\phi/\beta|_d$ configurations (see the discussion of 4.5.1.4), even though the degradation of flying qualities was due to sideslip problems with the low $|\phi/\beta|_d$ configurations and to bank angle problems with the moderate $|\phi/\beta|_d$ configurations. Since the break points were so close and since the figures describe different manifestations of the same phenomena, the break points were made identical for both the low $|\phi/\beta|_d$ configurations ($\Delta\beta$ versus ψ_β) and moderate $|\phi/\beta|_d$ configurations (p_{osc}/p_{av} versus ψ_β).

The sideslip excursions criteria were thus presented in the form shown in the sketch:



As with the p_{osc}/p_{av} requirement, it can be seen from this sketch that the specified value of $\Delta\beta$ varies significantly with ψ_β . This difference is almost totally due to the differences in ability to coordinate during

MIL-STD-1797A
APPENDIX A

turn entries and exits. Since ψ_β is a direct indicator of the difficulty a pilot will experience in coordinating a turn entry, variation of allowable $\Delta\beta$ with ψ_β is to be expected. For $-180 \text{ deg} < \psi_\beta < -260 \text{ deg}$, the pilot may coordinate; that is, right rudder pedal for right rolls. Thus, even if large sideslip excursions occur, by coordinating in the normal manner sideslip oscillations can readily be minimized. As ψ_β varies from -270 deg to -360 deg , coordination becomes increasingly difficult, and in the range $-360 \text{ deg} < \psi_\beta < 90 \text{ deg}$ cross controlling is required to effect coordination. Since pilots do not normally cross control and, if they must, have great difficulty in doing so, for $-360 \text{ deg} < \psi_\beta < -90 \text{ deg}$, oscillations in sideslip either go unchecked or are amplified by the pilot's efforts to coordinate with rudder pedals.

The parameter k relates the amount of allowable sideslips without rudder-pedal use to the roll performance requirements. Through this tie to roll performance requirements, the effect of Class and some of the effects of Flight Phase and Level are taken into consideration. While $\Delta\beta$ is relatively straightforward, the parameter k is a function of Flight Phase, aircraft Class, speed range, and actual roll performance. In addition, questions arise about the influence of the yaw controller, since the roll performance requirements of 4.5.8.1 allow use of yaw controls in some instances. While here $\Delta\beta$ is found with feet on the floor except from steady turns requiring rudder-pedal coordination, k is a measure of roll response with combined roll and yaw controls.

Because the required ϕ_t values of 4.5.8.1 are different for Levels 1, 2, and 3, use of k ($\phi_{t \text{ command}} / \phi_{t \text{ requirement}}$) has in the past involved separate values of $\phi_{t \text{ requirement}}$ for comparison with the Level 1 boundary and with the Level 2 boundary of $\Delta\beta/k$. The supporting data for this requirement do not show a need for such special treatment: the proper value of $\phi_{t \text{ requirement}}$ to use is that specified for Level 1 in 4.5.8.1 with rudder use if permitted there, and the proper value of $\phi_{t \text{ command}}$ will be the value obtained by performing the tests of 5.5.8.1. The idea is to limit roll-control-only sideslip to a value which is (a) proportional to the roll control used and (b) stated in terms of the amount of roll control needed to meet the Level 1 roll performance requirement.

As a result, the correct way to compute k is with the commanded value assuming rudder use as permitted by 4.5.8.1 and the required Level 1 ϕ_t value obtained from 4.5.8.1. The resulting $\Delta\beta/k$, whether Level 1 or not, is then compared to the requirements of 4.6.2. As shown in Supporting Data and Lessons Learned, this is a perfectly adequate way to define the parameters.

The need for a requirement limiting yaw response to roll controller is a result of dutch roll excitation for aircraft with low to moderate $|\phi/\beta|_d$. If $|\phi/\beta|_d$ is large, the dutch roll will be most noticeable in roll rate, and p_{osc}/p_{av} is the important criterion (see 4.5.1). In general, the available data suggest that $\Delta\beta/k$ is not as useful as p_{osc}/p_{av} when $|\phi/\beta|_d > 3.5 - 5.0$ (see Supporting Data).

Finally, some of the shortcomings discussed for p_{osc}/p_{av} in 4.5.1 are relevant here as well: for example, for very low dutch roll frequencies, the step roll control inputs must be very small (see AFFDL-TR-72-4 1). However, although an unstable spiral mode causes divergence in all lateral-directional degrees of freedom, the small amount of sideslip in that mode makes the dutch roll mode easier to sort out in the sideslip response than it is in the roll response (see Aircraft Dynamics and Automatic Control).

MIL-STD-1797A
APPENDIX A

SUPPORTING DATA

As was discussed, the data of AFFDL-TR-67-98 were the basis for developing the sideslip excursion requirements of MIL-F-8785B. Figure 237 shows the data as presented in AFFDL-TR-69-72; on figure 238, these data are compared directly to the $\Delta\beta/k$ versus ψ_β requirements of figure 235.¹¹

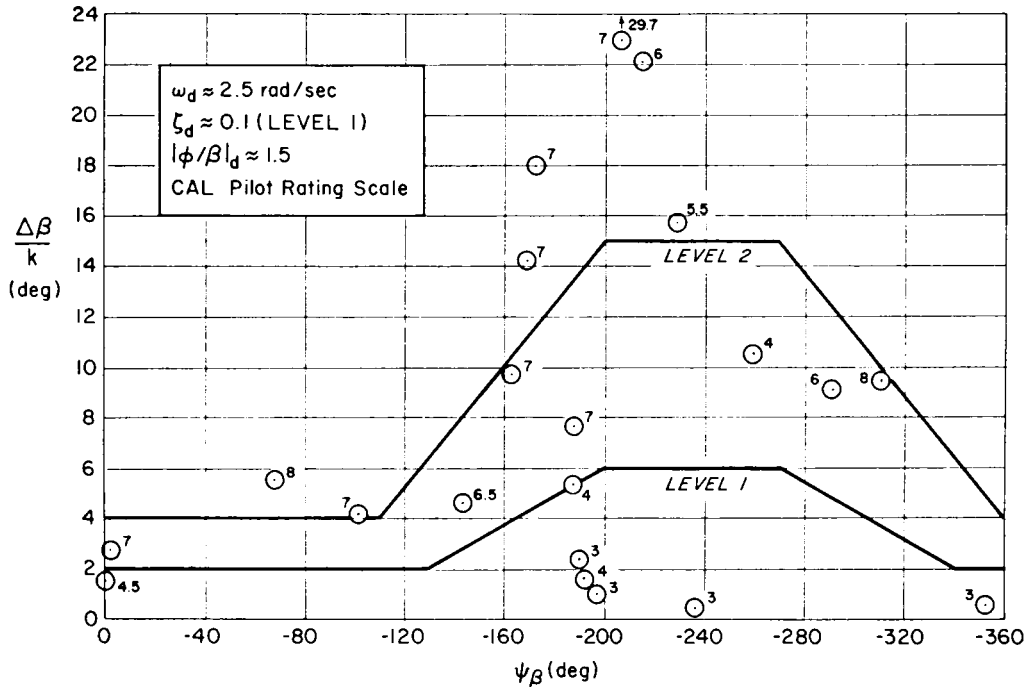

FIGURE 238. Flight Phase Category A data from AFFDL-TR-67-98 (AOIk, from AFFDL-TR-72-41).

The configurations of AFFDL-TR-72-36 that meet Level 1 dutch roll mode and p_{osc}/p_{av} requirements are illustrated on figure 239. The Cooper-Harper pilot ratings generally agree with the Level 1 and 2 boundaries. Note that the data with the highest value of $|\phi/\beta|_d$ ($= 5.0$) correlate well with the boundaries. However, it is generally true that larger values of $|\phi/\beta|_d$ result in small $\Delta\beta/k$, and any roll-yaw coupling problems would more likely show up only on the p_{osc}/p_{av} requirements of 4.5.1.

Figure 240 compares relevant Category B data of WADD-TR-61-147 with the boundaries of figure 235. Again, only those data for which T_S , T_R , ζ_d , ω_d , and p_{osc}/p_{av} are all Level 1 are shown. The low- $|\phi/\beta|_d$ data of figure 240a were used in AFFDL-TR-69-72 to develop the Category B boundaries. Figure 240b shows high- $|\phi/\beta|_d$ data; clearly, when $|\phi/\beta|_d$ is large, sideslip excursions are not a problem.

¹¹ The values of ψ_β in figures 237 and 238 do not agree for all data points. The ψ_β and $\Delta\beta/k$ of figure 238 were taken from AFFDL-TR-72-41, as was much of the data used in the following figures. No attempt has been made to account for the differences in ψ_β , or to decide which is the correct set of data. The more recent data (figure 238) result in a slightly poorer correlation with the boundaries than the earlier data (figure 237) which were used to define the boundaries in the first place.

MIL-STD-1797A
APPENDIX A

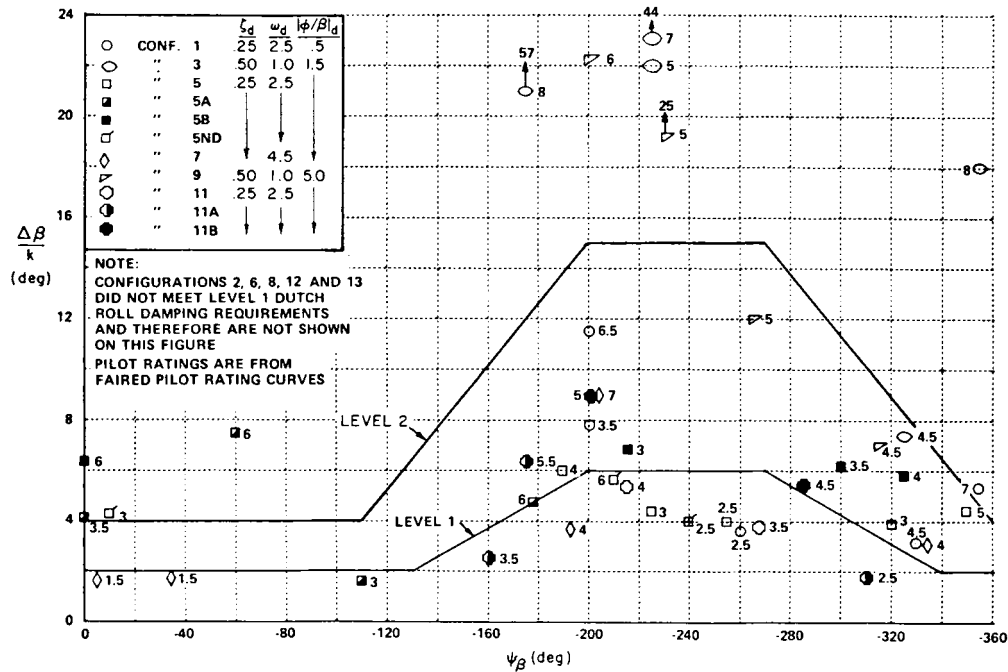

FIGURE 239. $\Delta\beta_{\max}/k$ versus ψ_β for evaluation points that meet Level 1 $p_{\text{osc}}/p_{\text{av}}$ criteria, Category A data (from AFFDL-TR-72-36).

Category C data from Princeton Univ Rpt 727 (also utilized in AFFDL-TR-69-72 to define the Category C limits) are given in figure 241. The few data points above the Level 1 boundary do not show very good correlation.

Figure 242 shows data from AFFDL-TR-70-145, and again correlation is poor: configurations in the Level 2 to 3 regions received Cooper-Harper ratings of 2, 2.5, and 3.

In summary, the supporting data for $\Delta\beta/k$ versus ψ_β appear to show a need for such a criterion for Category A and B Flight Phases; however, from the available data for Category C, other lateral-directional requirements sufficiently define acceptable flying qualities. For $|\phi/\beta|_d$ above some nominal value (≈ 5.0), $\Delta\beta/k$ adds little to the specification of flying qualities, and $p_{\text{osc}}/p_{\text{av}}$ is the important parameter.

As with the roll rate oscillation requirements of 4.5.1.4, the sideslip requirements of figure 235 are applicable for small inputs only, as in fine tracking. In order to be able to test for large control inputs, an additional but more lenient requirement has been specified. In this way the more comprehensive requirement of figure 235 on sideslip limitations can be incorporated without losing validity with large control inputs.

Comparisons of operational aircraft with the sideslip excursion requirements can be obtained from four AFFDL-sponsored validation reports (AFFDL-TR-72-141, AFFDL-TR-75-3, AFFDL-TR-70-155, and AFFDL-TR-71-134) as summarized in the following paragraphs.

MIL-STD-1797A
APPENDIX A

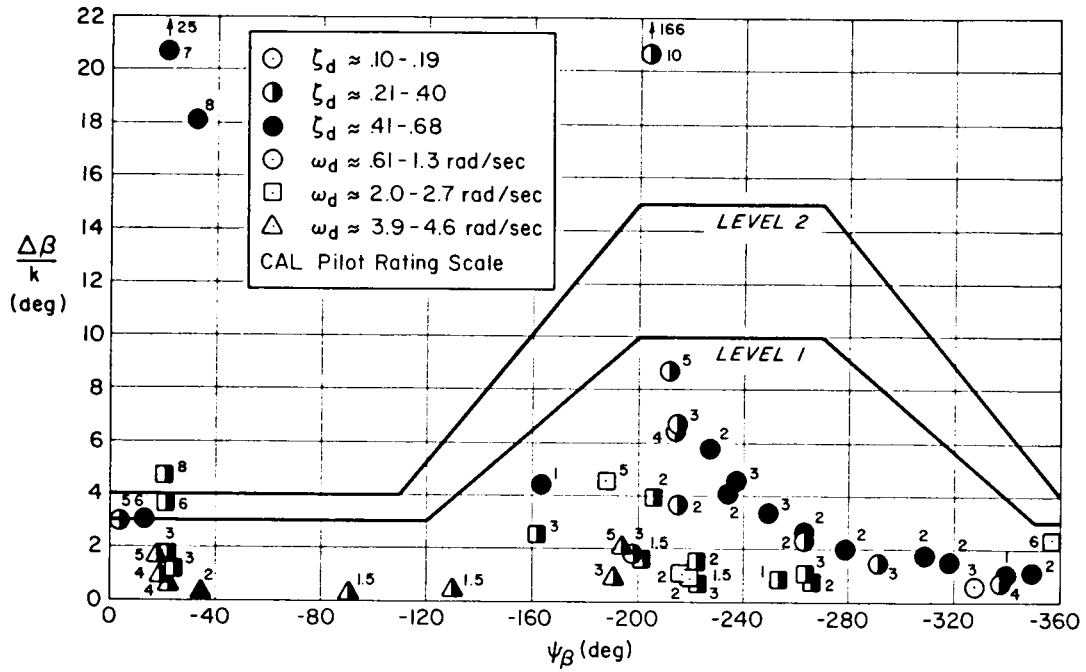

a) $|\phi/\beta|_d < 2.6$

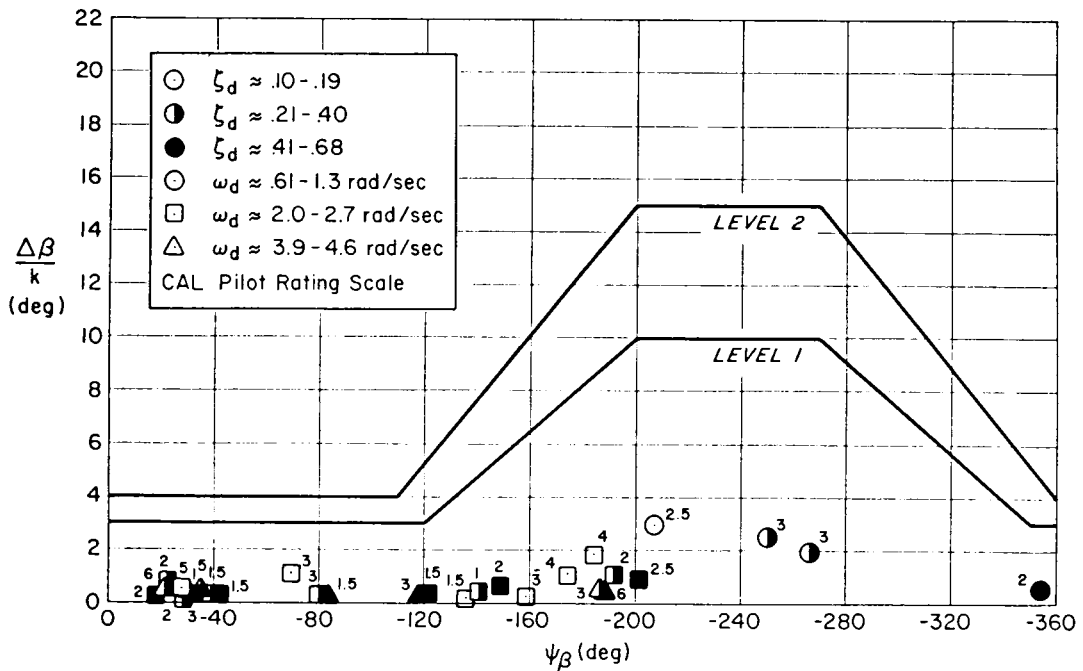

b) $2.9 < |\phi/\beta|_d < 7.5$

FIGURE 240. Category B data of WADD-TR-61-147.

MIL-STD-1797A
APPENDIX A

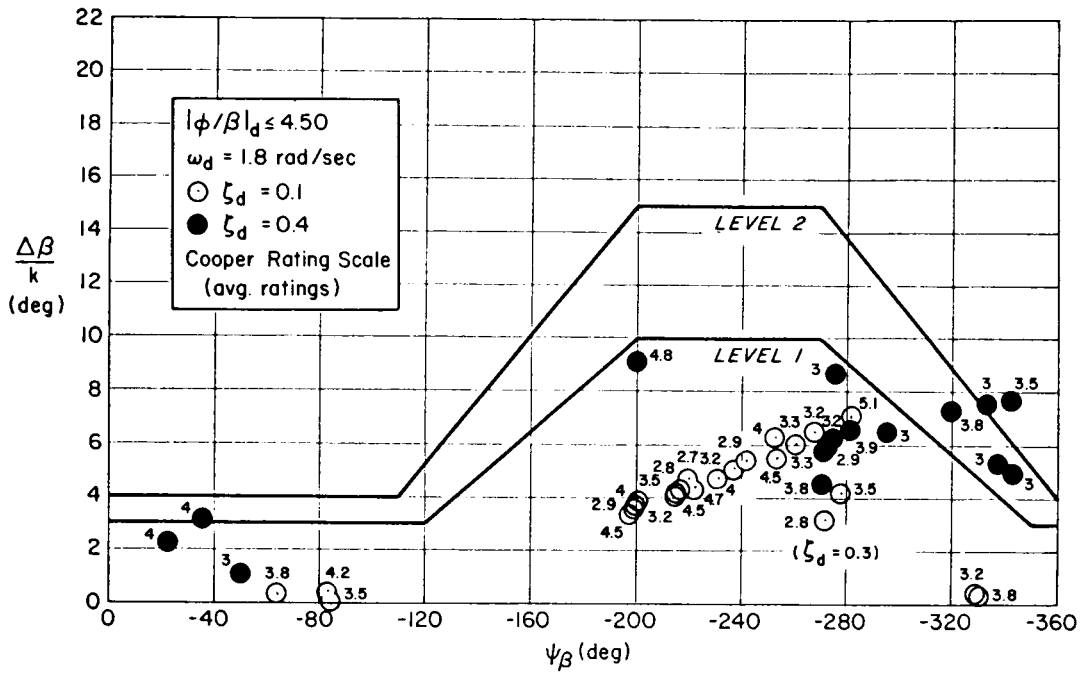

FIGURE 241. Category C configurations of Princeton Univ Rpt 727 ($\Delta\beta/k$, ψ_β from AFFDL-TR-72-41).

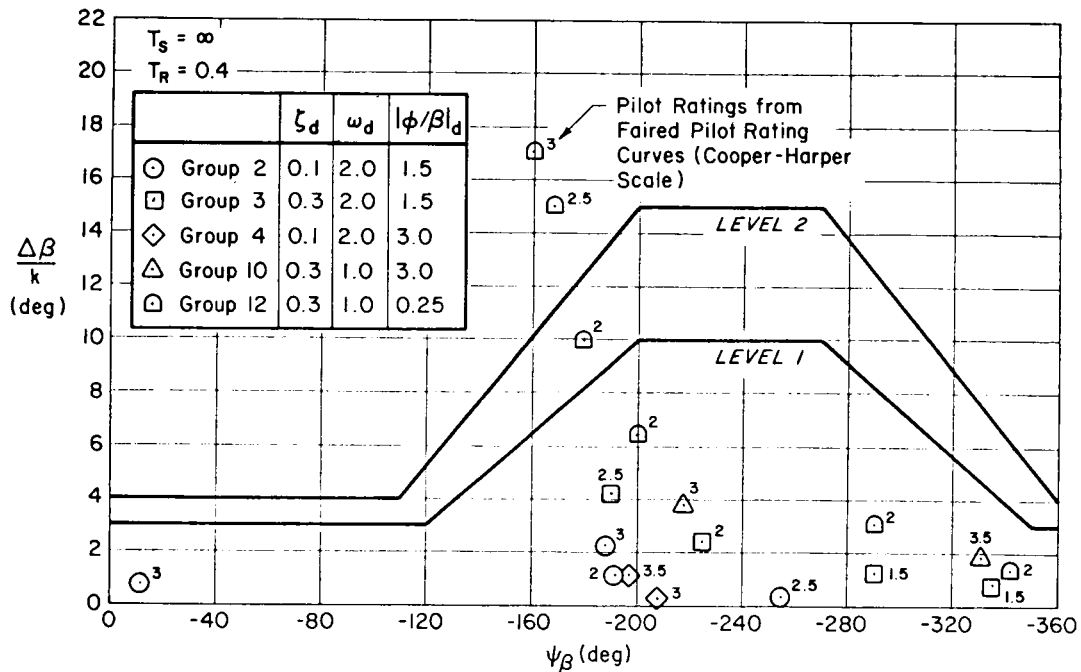

FIGURE 242. $\Delta\beta_{\max}/k$ versus ψ_β for configurations that meet Level 1 $p_{\text{osc}}/p_{\text{av}}$, ζ_d , and $\zeta_d\omega_d$ criteria (from AFFDL-TR-70-145).

MIL-STD-1797A
APPENDIX A

P-3B (Class III)

AFFDL-TR-72-141 discusses the characteristics of the P-3B and correlation with the large-input sideslip excursion requirements:

In PA, the adverse yaw observed ranged between about 12 degrees at 120 KEAS to a minimum of 3 degrees at about 170 KEAS [$k = 1.0$]. The pilot commentary indicated Level 1 flying qualities were associated with these results.... The results are felt to substantiate the Level 1 requirement of the specification for Category C Flight Phases.

The [Category A] results...revealed that the adverse yaw characteristics of the aircraft failed to meet the Level 1 requirements of the current specification between 130 KEAS ($\Delta\beta/k = 25^\circ$) and 190 KEAS ($\Delta\beta/k = 6^\circ$). In addition, the aircraft failed to meet the current Level 1 requirement in Flight Phase AS between 140 KEAS ($\Delta\beta/k = 13^\circ$) and about 180 KEAS ($\Delta\beta/k = 6^\circ$) while meeting the Level 1 requirement up to 360 KEAS ($\Delta\beta/k = 2^\circ$).... The comments which were received indicate that pilots would normally go ahead and coordinate the turn with pedal and would not be annoyed at the pedal coordination requirement.

C-5A (Class III)

Figure 243 shows C-5A flight test results compared with the large-input requirements. According to AFFDL-TR-75-3:

The sideslip excursions are not considered undesirable. Hence, the uniform applicability of the requirements to all classes of aircraft is questioned.... The requirement to hold the aileron command fixed until the bank angle has changed at least 90 degrees is unnecessary for Class III aircraft. The aileron command should be held long enough to establish the parameters, $\phi_{t_command}$ and $\Delta\beta$

Additional data for the C-141A, YC-141B, and C-5A are shown on figure 244 from AFFDL-TR-78-171. As described there:

Pilot rating data obtained during the YC-141B flight test program show a value of 2 (Harper-Cooper Rating Scale) with augmentation operative and 4 with the augmentation inoperative. These data indicate that the handling characteristics correspond to Level 1 conditions even though the data fall outside Level 1 requirements at the lower airspeeds.

It should be noted that the L-1011 nearly complies with roll performance requirements, but the sideslip excursions created as a result, as shown herein, exceed allowable limits (figure 244). The L-1011 sideslip excursions have not prompted comments of objection from flight test or airline pilots.

F-4 (Class IV)

Flight test data for the F4H-1 (F-4B) are shown on figure 245, from AFFDL-TR-70-155:

MIL-STD-1797A
APPENDIX A

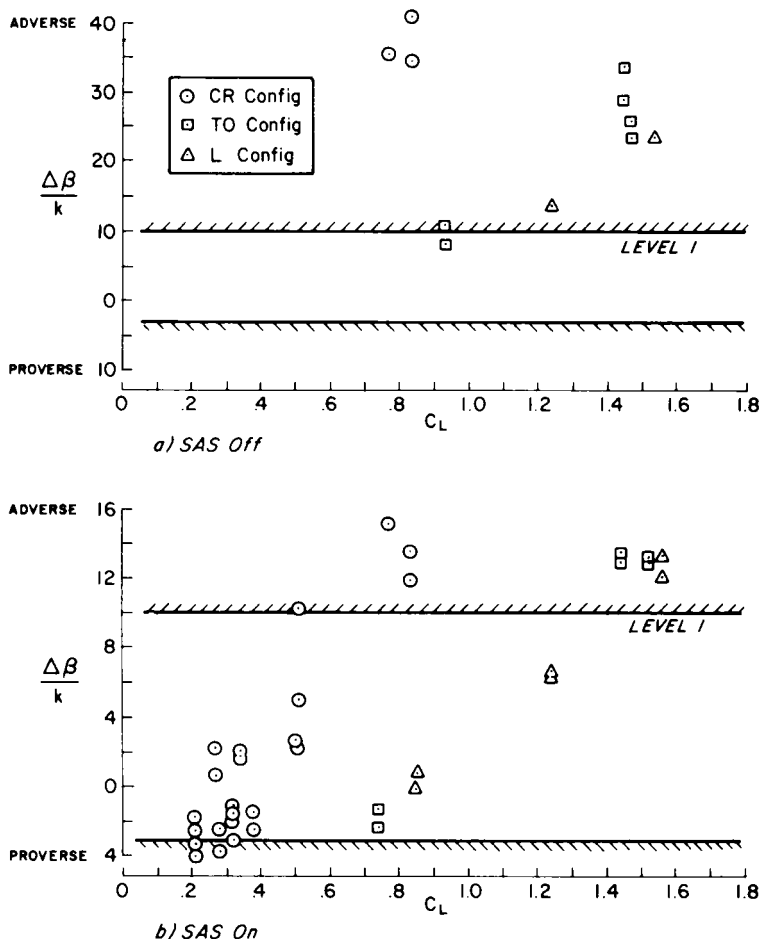

FIGURE 243. C-5A flight test data (from AFFDL-TR-75-3).

The Category A data (figure 245a)...provide good validation of the Level 1 adverse and proverse boundaries with the exception of two test points in which the roll command has induced proverse sideslip. These two points were rated Level 1 but fall outside the Level 1 proverse boundary. Available data do not permit evaluation of the Level 2 boundaries.

The PA data -- Category C -- [with 5 deg ARI authority, figure 245b] did not correlate as well. These data were given a blanket rating of Level 2, however a significant number of test points met the specification Level 1 requirements. Each of these had relatively high roll performance resulting in a higher k and a correspondingly higher allowable b. Adverse sideslip was in the low range compared to the other data.

The data of [figure 245b] -- in which the PA configuration lateral-directional characteristics were modified by increasing ARI rudder authority to $\pm 15^\circ$ -- provide inconclusive results. From the pilot comment, an estimated Level 1 was given to all the data. However, approximately half of the data are Level 2 according to the requirement.

When the PA configuration data...are combined as shown in figure [245b], there is some indication that the Level 1 adverse boundary may be a function of airspeed.

MIL-STD-1797A
APPENDIX A

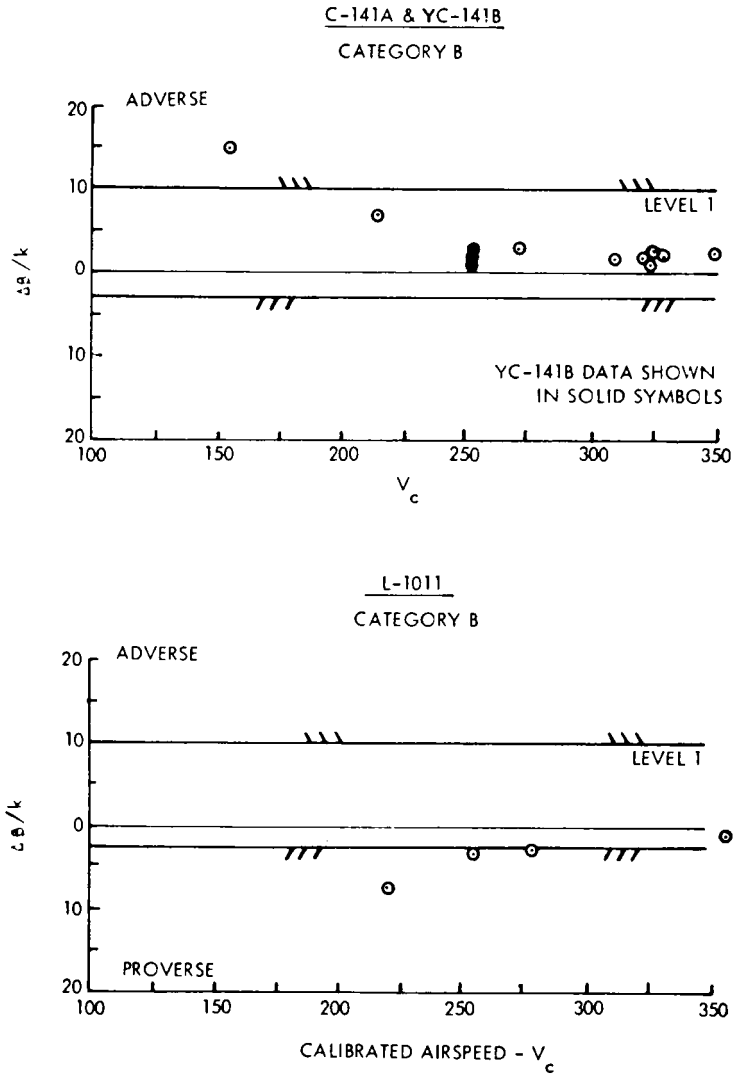

FIGURE 244. Sideslip excursion data for Class III aircraft in Category B Flight Phases (from AFFDL-TR-78-171)

F-5A (Class IV)

Test data for the F-5A are compared to the small-input requirements on figure 246a, and the large-input requirements on figure 246b, from AFFDL-TR-71-134. The F-5A is seen to comply with the limits, though no pilot rating information is given.

Possible Revision

Calspan proposed a revision to the requirement in AFFDL-TR-72-41. The new handling quality parameters proposed are:

$$\frac{1}{\omega_d} \frac{V_T}{g} \frac{|\Delta\beta|_{t < 1.2T_d}}{\hat{\phi}_1} \quad \text{versus } \psi_{\beta_{\text{impulse}}}$$

MIL-STD-1797A
APPENDIX A

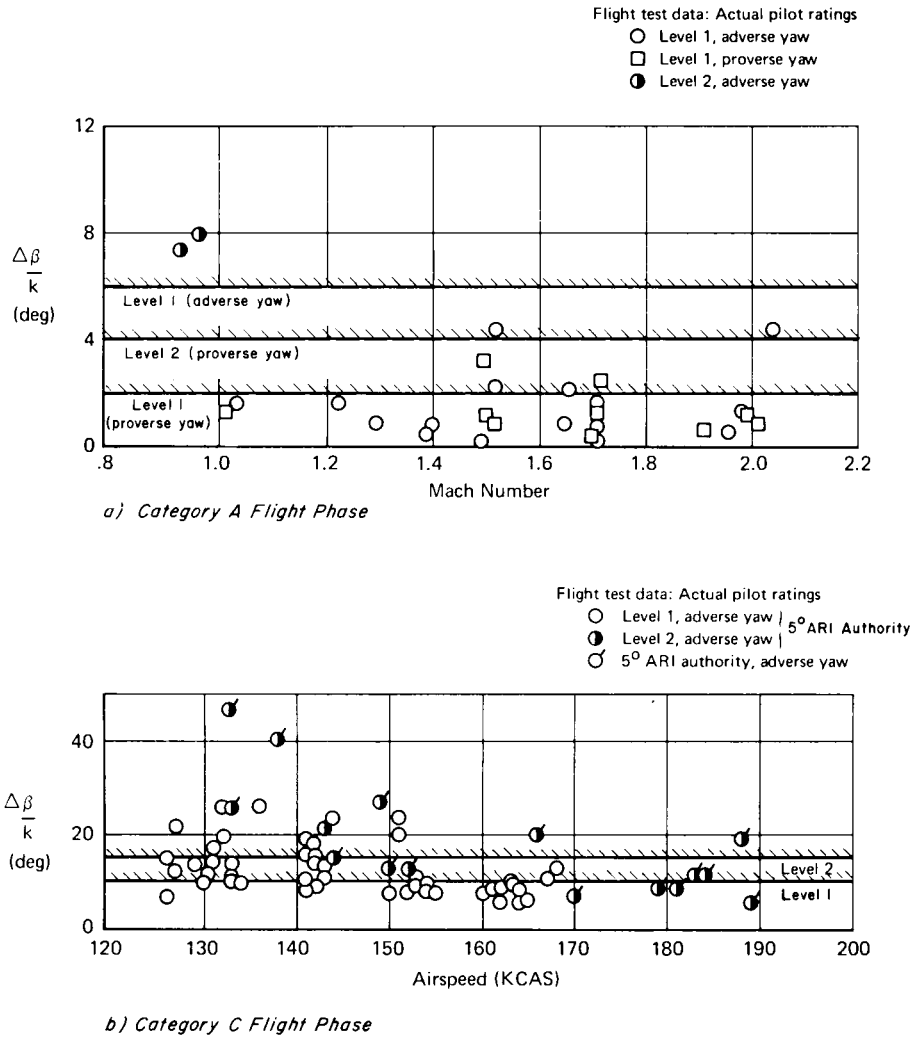

FIGURE 245. Sideslip excursions for F4H-1 airplane (from AFFDL-TR-70-155).

where again the hat (^) indicates that the spiral mode has been deleted from the time history before measurement of ϕ_1 . The above-noted trend with airspeed is seen to be included in the requirement.

Data comparisons with AFFDL-TR-72-41 parameters show insufficient justification for adopting them. For example, using the data of AFFDL-TR-67-98 (Category A), correlations are almost identical for the Calspan proposal as for $\Delta\beta/k$ vs. ψ_β (48% vs. 46%). Likewise, AFFDL-TR-70-145 data (Category C) show no real improvement (70% vs. 66%). Some such parameters may be necessary, but more work is needed to develop criteria which correlate more highly with pilot evaluation data.

MIL-STD-1797A
APPENDIX A

Configuration	Altitude (ft)	MN	Entry N_z (g)	Sym
—————	35,000	.61	1.0	○
—————	10,000	.70	3.0	○
—————	10,000	.80	3.5	●
—————	20,000	.90	3.0	●
○ — ○ — ○	10,000	.92	4.0	△
○ — ○ — ○	20,000	.80	4.0	△
○ — ○ — ○	20,000	.92	4.0	▲
○ — ○ — ○	35,000	.925	-0.2	▲
○ — ○ — ○	9,900	.79	2.7	□
○ — ○ — ○	10,000	.80	1.0	△

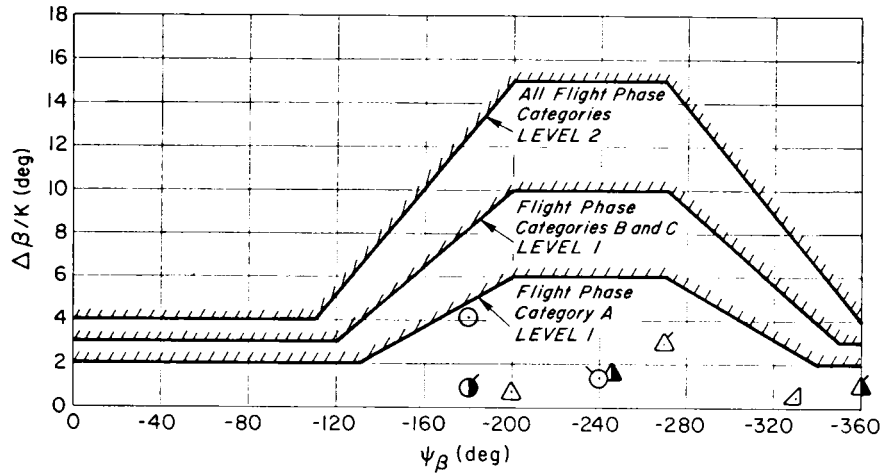

a) Small Inputs

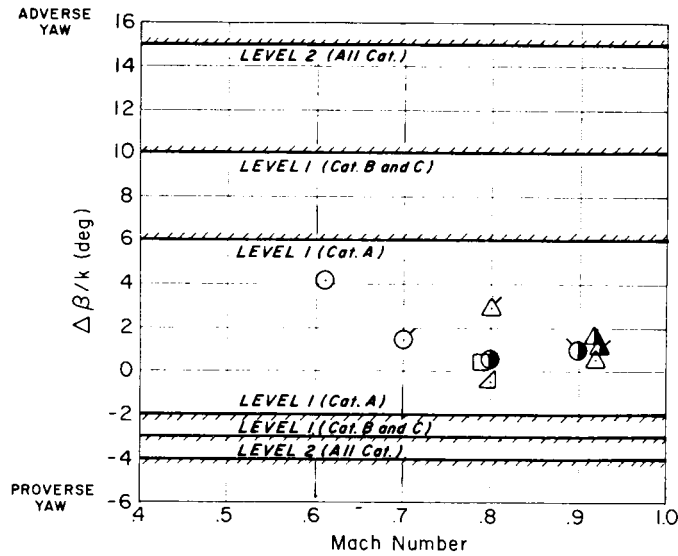

b) Large Inputs

FIGURE 246. F-5A flight test data.

MIL-STD-1797A
APPENDIX A

COORDINATION IN TURN ENTRY AND EXIT -- ALTERNATIVE 2

There is no such alternative requirement in MIL-F-8785C.

The yaw control crossfeed necessary to maintain zero sideslip shall result in a ratio of initial yawing acceleration to initial rolling acceleration for a step roll control input, \dot{r}_0/\dot{p}_0 , within the limits shown on figure 247 for Levels 1 and 2. In addition, for values of $|\dot{r}_0/\dot{p}_0|$, less than 0.07, the crossfeed parameter $\delta'_{rp}(3)$ must be within the limits of table XLIV.

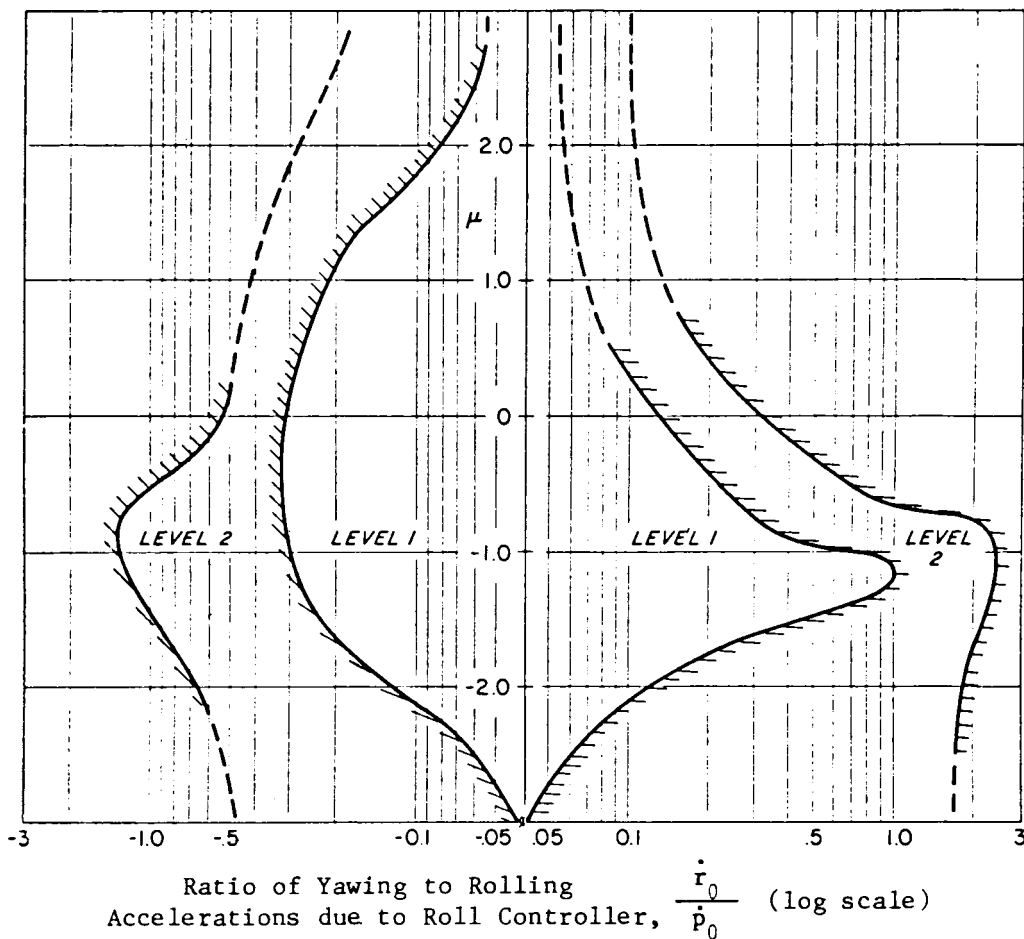

FIGURE 247. Crossfeed parameter boundaries.

TABLE XLIV. Limits on $\delta'_{rp}(3)$ for $|\dot{r}_0/\dot{p}_0| < 0.07$.

LEVEL	ADVERSE YAW	PROVERSE YAW
1	-0.39	0.11
2	-1.15	0.78

This requirement is offered as an alternative to bounds on sideslip excursions, $\Delta\beta/k$ versus ψ_β . It is stated directly in terms of the magnitude and shaping of rudder pedal inputs needed to coordinate turns. Hence it is intended as analytical guidance.

MIL-STD-1797A
APPENDIX A

The ability to make precise changes in aircraft heading is a key factor in pilot evaluation of lateral-directional handling qualities. With the other qualities (e.g., adequate roll response, yaw frequency/damping, etc.) assumed to be good, any deficiencies in heading control are directly traceable to excitation of the dutch roll mode due to roll-yaw cross-coupling effects. It is a commonly accepted piloting technique to reduce these excursions by appropriate use of the aileron and rudder, usually referred to as "coordinating the turn." The problem is that existing criteria for heading control ($\Delta\beta/k$, or AFFDL-TR-72-41, FAA-RD-70-61, or WP-189-3) are based on aileron-only parameters, and the effects of rudder control are only indirectly apparent as they may have influenced individual pilot ratings. That these criteria are not satisfactory is shown in NASA-CR-2017, where several configurations that violated boundaries based on aileron-only parameters were given good to excellent pilot ratings. The approach taken here is that for an otherwise acceptable aircraft the aileron-rudder shaping necessary to coordinate the turn is a dominant factor in pilot evaluation of heading control. In this regard it is important to recognize that heading control is basically an outer loop and cannot be satisfactory if the inner bank angle loop is unsatisfactory. Table XLV contains a set of requirements intended to serve as a checklist for good roll control.

A. Analysis and Basic Concept

In general, coordinated flight implies minimum yaw coupling in roll entries and exits, which can be quantified in many ways, e.g.: a) zero sideslip angle ($\beta = 0$); b) zero lateral acceleration at the c.g.; c) turn rate consistent with bank angle and speed ($r = g\phi/U_0$); and d) zero lateral acceleration at the cockpit (ball in the middle).

TABLE XLV. Ground rules for application of rating data to heading control criteria.

1) T_R meets the Level 1 requirements of 4.5.1.1
2) ω_d meets the Level 1 requirements of 4.6.1.1
3) ζ_d meets the Level 1 requirements of 4.6.1.1
4) $ \phi/\beta _d < 1.5$ when turbulence is a factor and $ N'_{\delta_{as}}/L'_{\delta_{as}} (\dot{r}_o/\dot{p}_o) > 0.03$ or
5) Meets L'_β vs. ω_d boundaries when $ \dot{r}_o/\dot{p}_o \leq 0.03$ (figure 248)
6) Meets Level 2 p_{osc}/p_{av} according to 4.5.1.4

Conditions a through c are equivalent when the side forces due to lateral stick, $Y_{\delta_{as}}$, and rudder pedal, $Y_{\delta_{rp}}$, are very small, which is usually the case. The fourth turn coordination criterion is complicated by pilot location effects which, however, appear to be more associated with ride qualities than with heading control itself (NASA-CR-2017). Based on these considerations it appears that sideslip angle is an appropriate indicator of turn coordination.¹² Accordingly, the following formulation undertakes to identify the parameters that govern the aileron-rudder shaping required to maintain coordinated flight as defined by zero sideslip angle ($\beta = 0$).

¹² It has been suggested that pilots are taught to center the ball in turns and therefore a_y would be the more correct parameter. However, the real objective is to keep sideslip near zero so that the aircraft tracks bank angle. In fact, when turn coordination is critical, as on the AV-8 Harrier, a yaw string is used to display β to the pilot. Also, glider pilots use a yaw string because turn coordination is a critical factor in these aircraft. (Generally, sideslip bias at the nose due to steady yaw rate is small). Therefore, the proponents of β feel that β and not a_y is the appropriate parameter. For most flight conditions -- even for most aircraft -- the difference between a_y and β is very small.

MIL-STD-1797A
APPENDIX A

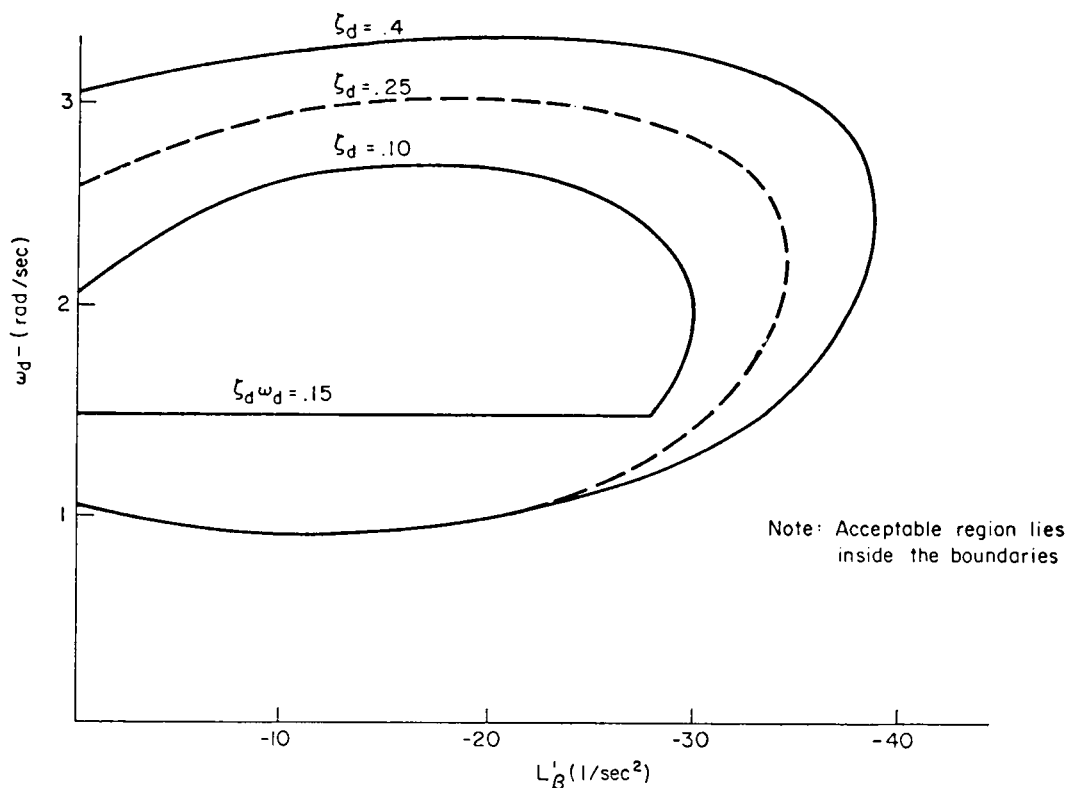

FIGURE 248. Pilot rating boundaries for acceptable roll control in turbulence with $|\dot{r}_o/\dot{p}_o| \leq 0.03$ (from Princeton Univ Rpt 797).

With an aileron stick or wheel crossfeed to the rudder pedals, Y_{CF} , the rudder pedal deflection produced is

$$\Delta\delta_{rp} = Y_{CF} \delta_{as} \quad (1)$$

where δ_{as} is the lateral stick (or wheel) deflection at the pilot's grip. For the assumed ideal (zero sideslip) coordination, in terms of the β/δ_{as} and β/δ_{rp} transfer functions:

$$\beta = \left(\frac{N_{\delta_{as}}^{\beta}}{\Delta} + Y_{CF} \frac{N_{\delta_{rp}}^{\beta}}{\Delta} \right) \delta_{as} = 0 \quad (2)$$

At large bank angles and high roll rates the equations of motion become nonlinear, with possibilities that trigonometric functions or higher-order terms will be of significant size. Nevertheless, the character of the motion generally will be shown by the linear analysis. $N_{\delta_{as}}^{\beta}$ and $N_{\delta_{rp}}^{\beta}$ are the numerators of the indicated transfer functions and Δ the denominator, as in Aircraft Dynamics and Automatic Control. Therefore the ideal crossfeed is:

$$Y_{CF} = \frac{\delta_{rp}}{\delta_{as}} = -\frac{N_{\delta_{as}}^{\beta}}{N_{\delta_{rp}}^{\beta}} \quad (3)$$

MIL-STD-1797A
APPENDIX A

For augmented aircraft these numerators are of high order and cannot be generalized. However, aircraft with complex augmentation systems represented by higher-order systems (HOS) tend to respond to pilot inputs in a fashion similar to conventional unaugmented aircraft or low-order systems (LOS). In fact, experience with longitudinal pitch dynamics (see 4.2.1.2 and "Handling Qualities of Aircraft with Stability and Control Augmentation Systems - A Fundamental Approach") has shown that a HOS which cannot be fit to a LOS form generally is unsatisfactory to the human pilot.

Based on the approximate factors for conventional aircraft obtained from Aircraft Dynamics and Automatic Control, the appropriate LOS form for Y_{CF} is, in its usual factored form, with time constants T_i :

$$Y_{CF} = \frac{N'_{\delta_{as}} [s + A_{as}(g/U_0)] [s + (1/T_{\beta_{as}})]}{Y_{\delta_{rp}}^* [s + A_{rp}(g/U_0)] [s + (1/T_{\beta_{rp}})] [s - (N'_{\delta_{rp}}/Y_{rp}^*)]} \quad (4)$$

where

$$Y_{\delta_{rp}}^* = (\delta Y / \delta_{rp}) / (mU_0) = \rho g U_0 / [2(W/S)] \cdot C_{y_{\delta_{rp}}}$$

$$L'_j = \frac{L_j + N_j I_{xz} / I_x}{1 - I_{xz}^2 / (I_x I_z)} \quad N'_j = \frac{N_j + L_j I_{xz} / I_z}{1 - I_{xz}^2 / (I_x I_z)}$$

$$A_i = \frac{L'_r - (L'_{\delta_i} / N'_{\delta_i}) N'_r}{L'_p - (L'_{\delta_i} / N'_{\delta_i}) [N'_p - (g/U_0)]}$$

$$1/T_{\beta_i} = -L'_p + (L'_{\delta_i} / N'_{\delta_i}) [N'_p - (g/U_0)]$$

and $i = as$ (aileron stick) or rp (rudder pedal). For the frequency range of interest, i.e., excluding both low and high frequencies [$A_i (g/U_0) \ll \omega \ll N'_{\delta_{rp}} / Y_{\delta_{rp}}^*$], Y_{CF} generally is of first order:

$$Y_{CF} = \frac{N'_{\delta_{as}} [s + 1/T_{\beta_{as}}]}{N'_{\delta_{rp}} [s + 1/T_{\beta_{rp}}]} \quad (5)$$

We would expect the approximation to hold in a great many cases. Whether or not this is a good approximation in any given case, it seems reasonable that pilots would dislike to use a crossfeed more complicated than this. Now, the rudder sensitivity can be optimized separately and does not usually represent a basic airframe limitation, so it is appropriate to remove that from consideration. But even though the magnitude of δ_{rp} required for coordinating a roll command can be dispensed with thus, the size of the uncoordinated yaw response is of course a pilot concern. A suitable "gain" parameter, then, is $\dot{r}_o / \dot{p}_o = N'_{\delta_{as}} / L'_{\delta_{as}}$. By this immediate cue a pilot can judge his need to add crossfeed for a step roll command. Accordingly, the LOS crossfeed parameter, Y'_{CF} , is given as¹³:

¹³ All derivatives are in the stability axis system.

MIL-STD-1797A
APPENDIX A

$$Y'_{CF} = \frac{N'_{\delta_{as}} \left[s + 1/T_{\beta_{as}} \right]}{L'_{\delta_{as}} \left[s + 1/T_{\beta_{rp}} \right]} \quad (6)$$

Equation 6 indicates that the aileron-to-rudder shaping required to maintain coordinated flight ($\beta = 0$) is directly related to the separation between the aileron (wheel or stick) and rudder (pedal) sideslip zeros.

As a basis for direct correlation with pilot opinion, a "rudder shaping parameter," μ , is arbitrarily defined as the separation between $1/T_{\beta_{rp}}$ and $1/T_{\beta_{as}}$, normalized by $1/T_{\beta_{rp}}$, i.e.,

$$\mu = \frac{(1/T_{\beta_{as}}) - (1/T_{\beta_{rp}})}{1/T_{\beta_{rp}}}$$

which simplifies to

$$\mu = (T_{\beta_{rp}}/T_{\beta_{as}}) - 1 \quad (7)$$

Then, from either equation 5 or equation 6, $(1 + \mu)$ is the ratio of steady δ_{rp} to the initial δ_{rp} . The frequency response characteristics of Y'_{CF} , equation 6, as a function of the sign of $N'_{\delta_{as}}/L'_{\delta_{as}}$ and the value of μ , are shown on figure 249. The shaping of the rudder response is determined by μ . These parameters are summarized in terms of their analytical and pilot-centered functions in table XLVI.

The parameters \dot{r}_o/\dot{p}_o or $N'_{\delta_{as}}/L'_{\delta_{as}}$ and μ are a natural choice for correlation of heading-control pilot rating data since they, plus the value of $T_{\beta_{rp}}$, completely define the approximate aileron-to-rudder crossfeed necessary for turn coordination ($T_{\beta_{rp}}$ often is approximately the same value as T_R). Such an ideal crossfeed is difficult to isolate with simple flight test procedures, but is nevertheless considered a viable correlation concept because the rationale is straightforward and the parameters can be extracted from flight data via parameter identification techniques. Correlation with available data is shown subsequently.

MIL-STD-1797A
APPENDIX A

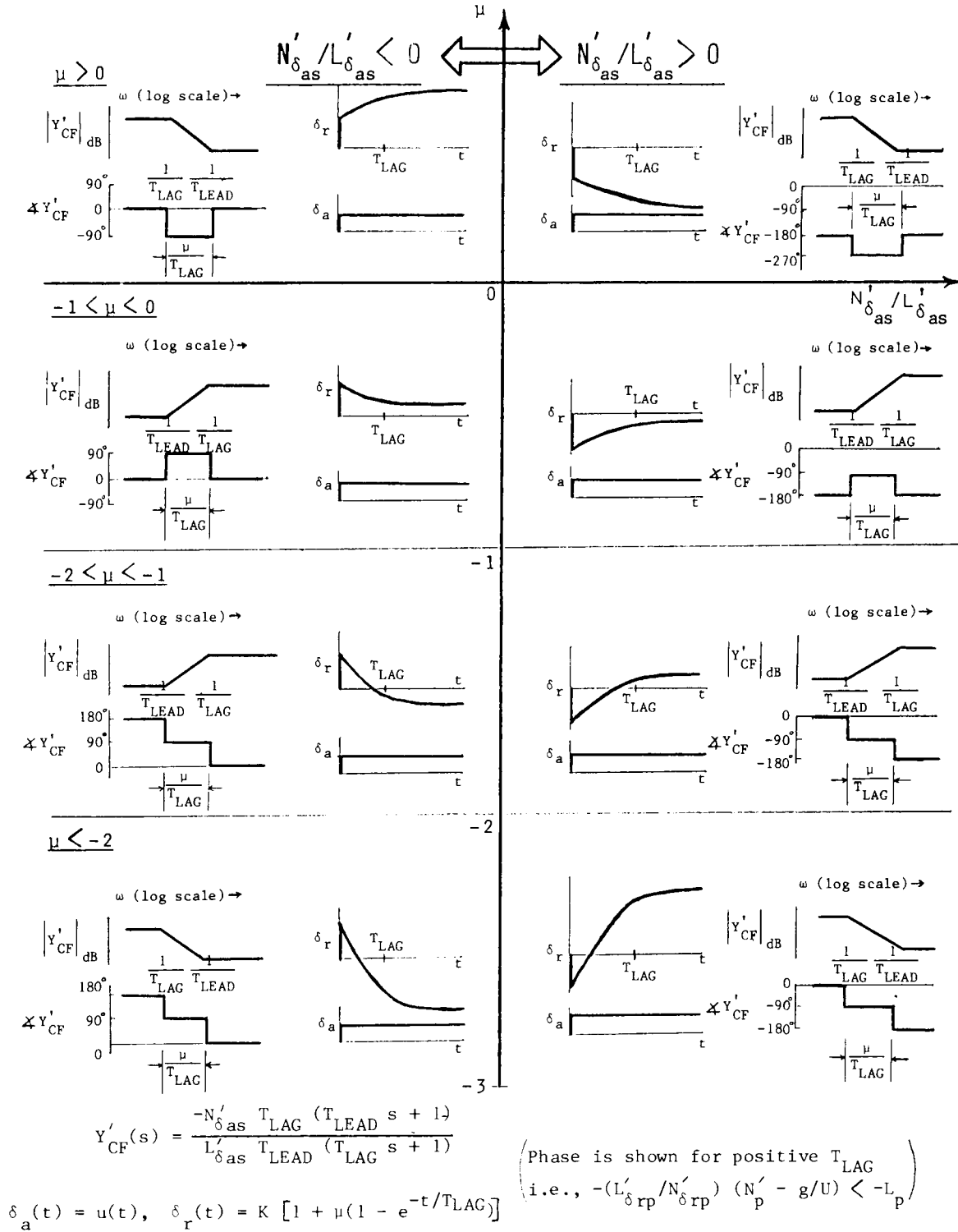

FIGURE 249. Bode asymptotes and time response of crossfeed.

MIL-STD-1797A
APPENDIX A

TABLE XLVI. Parameters defining the LOS representation of the aileron-rudder crossfeed.

PARAMETER	ANALYTICAL FUNCTION	PILOT-CENTERED FUNCTION
μ	Defines shape of Y_{CF}	Determines complexity of rudder activity necessary for ideally coordinated turns. Also, defines phasing of heading response when rudder is not used.
\dot{r}_o/\dot{p}_o or $N'_{\delta_{as}}/L'_{\delta_{as}}$	Defines magnitude of Y_{CF}	Determines high-frequency yawing induced by aileron inputs.

The rudder-pedal time history required to coordinate a unit step wheel or stick input is:

$$\delta_{rp}(t) = \left[1 + \mu \left(1 - e^{-t/T_{\beta rp}} \right) \right] N'_{\delta_{as}} / N'_{\delta_{rp}} \quad (8)$$

so

$$\delta_{rp}(t \rightarrow \infty) / \delta_{rp}(t \rightarrow 0+) = 1 + \mu$$

Note that $\delta_{rp}(t)$ refers to the rudder pedal motion (other surface inputs are flight control system crossfeeds and SAS). The criterion value of t is properly set by the lower limit on the frequency range of interest for piloted heading control. The simulation experiments of NASA CR-239 indicated that a minimum heading crossover frequency of about 1/3 rad/sec was necessary for desirable handling qualities. Therefore, a time of 3 sec rather than infinity was selected as pertinent to a pilot-centered characterization of crossfeed properties. (While this makes little difference for the approximation to g , it may be significant for the exact solution.) Recognizing further (equation 4) that $T_{\beta rp} \doteq -1/L_p$ approximately equals the roll mode time constant, T_R , and that the latter must generally be less than 1.0 to 1.4 sec for acceptable roll control (4.5.1.1) sets the following limits on the exponential in Equation 8:

AIRCRAFT	T_R	e^{-3/T_R}
Small, light or highly maneuverable	< 1.0 sec	< 0.049
Medium to heavy weight, low to medium maneuverability	< 1.4	< 0.117

Accordingly, equation 9 reduces within a maximum error of 5-10 percent, depending on aircraft class, to

$$\mu \doteq \delta_{rp}(3) - 1 \quad (10)$$

for a $\delta_{rp}(0)$ of 1. This simple relationship was used to compute μ for the pilot rating correlations shown under "Supporting Data." It should also be noted that, since the high-frequency gain is set to unity by normalizing with respect to $\delta_{rp}(0)$, the normalized rudder parameter, $\delta_{rp}(3)$, may be calculated from Y_{CF} (Equation 3, 4, or 5) or Y'_{CF} (equation 6).

MIL-STD-1797A
APPENDIX A

However, before this simple formula can be applied it is necessary to avoid the high-frequency responses that occur due to pairs of roots that frequently occur with complex SAS installations having associated higher-order β numerators. For example, a simple washed-out yaw rate feedback and a first-order lagged aileron/rudder crossfeed results in seventh-order β numerators of otherwise unaugmented aircraft. Most of the zeros of these polynomials occur at very high frequency, having negligible effect on the dynamics near the pilot's crossover frequency, and therefore should not be accounted for in the shaping function μ . The standard procedure utilized to compute the values of g was to eliminate all roots of the β parameters above values of 6 rad/sec in pairs, i.e., keeping their order relative to each other the same (e.g., a third over fourth order would be reduced to a second over third order, etc.). Roots above 6 rad/sec which do not occur in pairs are left unmodified. The point of deleting the high-frequency root pairs is just to find the rudder/aileron crossfeed ratio that the pilot should apply.

The following example illustrates a typical computation of μ and the effect of removing the high-frequency roots from equation 2. The aileron/rudder crossfeed for one of the AFFDL-TR-69-41 configurations used in the pilot rating correlations is given as:

$$\frac{\delta_{rp}}{\delta_{as}} = \frac{.19 (s - .102)(s - .922)(s + 605.2)}{(s - .057)(s + 5.6)(s + 109.9)} \quad (11)$$

As discussed above, all roots above 6 rad/sec are removed in pairs and the high-frequency gain (0.19) is set to unity, resulting in the following equation:

$$\frac{\delta_{rp}}{\delta_{as}} = \frac{(s - .102)(s - .922)}{(s - .057)(s + 5.6)} \quad (12)$$

The rudder time responses to a unit wheel input for equations 11 and 12 are plotted on figure 250. Removal of the high-frequency roots is seen to replace the initial rapid rudder reversal with a unity initial condition. These responses are essentially equivalent to the pilot, who sees the necessity to use immediate rudder with aileron inputs (which must be removed 1/2 sec later). The value of g corresponding to this response is $\delta_{rp}(3) - 1 = -1.17$. In this case apparently we also could have removed the low-frequency pole and zero with no ill effect.

B. Physical Interpretation

A physical interpretation is that δ_{rp} is the sum of an initial amount to counter $N'_{\delta_{as}} \delta_{as}$ and a variable amount proportional to $N'_p p$. The possibilities are enumerated in table XLVII.

The iso-opinion lines on figure 247 indicate that some values of the rudder shaping parameter, μ , are more desirable than others in that they are less sensitive to an increase in aileron yaw. The following observations help to explain this trend in terms of pilot-centered considerations:

1. Moderately high proverse (positive) $N'_{\delta_{as}}$ is acceptable in the region where $\mu \doteq -1$. Physically, this corresponds to a sudden initial heading response in the direction of turn followed by decreasing rudder requirements. (Required steady-state rudder is zero when $\mu = -1$, see figure 249). It is felt that the pilots are accepting the initial proverse yaw as a heading lead and are not attempting to use cross-control rudder.
2. The allowable values of proverse $N'_{\delta_{as}}$ decrease rapidly as μ becomes more negative than -1. Physically this corresponds to an increase in the need for low-frequency rudder activity (see figure 249). A requirement for cross control is particularly objectionable.

MIL-STD-1797A
APPENDIX A

3. The pilot ratings are less sensitive to the required rudder shaping when $N'_{\delta_{as}}$ is negative (adverse yaw, negative \dot{r}_o/\dot{p}_o). Recall that adverse yaw is consistent with conventional piloting technique (rudder with the turn to augment roll into the turn).

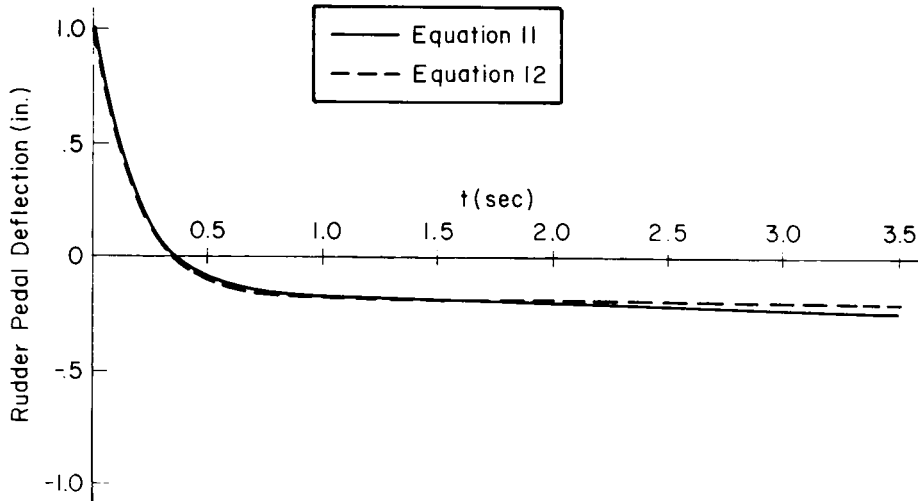

FIGURE 250. Effect of removing high-frequency roots from numerators.

TABLE XLVII. Physical interpretation of μ .

VALUE OF RUDDER SHAPING PARAMETER	ROLL-YAW CROSS-COUPLING CHARACTERISTICS
$\mu > 0$	$N'_{\delta_{as}}$ and N'_p are additive, indicating that the cross-coupling effects increase with time after an aileron input
$\mu = 0$	$N'_p = g/U_0$, indicating that all roll-yaw cross-coupling is due to $N'_{\delta_{as}}$. The aileron-rudder crossfeed is therefore a pure gain.
$-1 < \mu < 0$	$N'_{\delta_{as}}$ and N'_p are opposing. Initial cross-coupling induced by $N'_{\delta_{as}}$ is reduced by N'_p as the roll rate builds up. Exact cancellation takes place when $\mu = -1$, resulting in a zero rudder requirement for steady rolling.
$\mu < -1$	Low-frequency and high-frequency cross-coupling effects are of opposite sign, indicating a need for rudder reversals for coordination. If rudder is not used, the nose will appear to oscillate during turn entry and exit.

C. \dot{r}_o/\dot{p}_o Near Zero

Control cross-coupling effects are obviously not a factor when $|N'_{\delta_{as}}/L'_{\delta_{as}}|$ ($|\dot{r}_o/\dot{p}_o|$) is small. This may occur when the basic control cross-coupling is negligible or with augmentation systems that result in ideal crossfeed, Y_{CF} , having denominators of higher-order dynamics than numerators (e.g., the augmented $N'_{\delta_{as}}$ is Zero). When $|N'_{\delta_{as}}/L'_{\delta_{as}}|$ is identically zero, for unaugmented conventional aircraft the required aileron-rudder crossfeed takes the form

$$Y'_{CF} = \frac{N'_{\delta_{rp}}}{L'_{\delta_{rp}}} \cdot Y_{CF} = \frac{-(N'_p - g/U_0) [s + (g/U_0)N'_r / (N'_p - g/U_0)]}{s(s + 1/T_{\beta_{rp}})} \quad (13)$$

The Bode asymptotes are shown on figure 251. The rudder magnitude required to coordinate mid-frequency and high-frequency aileron (wheel) inputs is seen to be dependent on the roll cross-coupling, $g/U_0 - N'_p$, whereas low-frequency rudder requirements are dependent on N'_r . The required rudder shaping has the characteristics of a rate system (ramp δ_{rp} to step δ_{as} input) at low and high frequency. Accordingly, aileron-rudder shaping per se is not the essence of the problem, which reduces instead to concern with the general magnitude of the required rudder crossfeed.

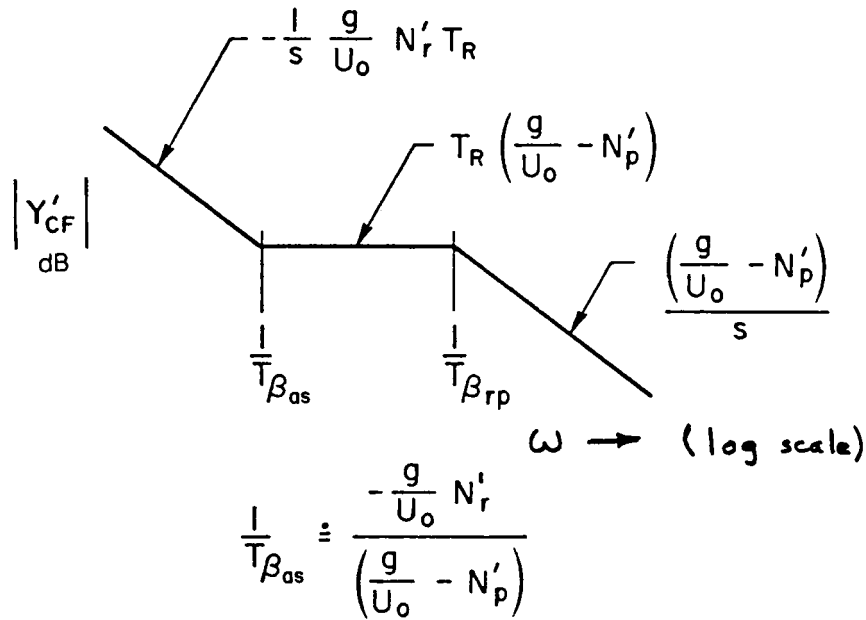

FIGURE 251. Required crossfeed for $\dot{r}_o = 0$.

From figure 251 it is seen that $g/U_0 - N'_p$ provides a good measure of such magnitude; and, in fact, correlation of pilot rating data (for $|N'_{\delta_{as}}/L'_{\delta_{as}}| < 0.03$) with $g/U_0 - N'_p$ is quite good. However, difficulties associated with estimating an effective $g/U_0 - N'_p$ for augmented airframes present practical problems which make this parameter somewhat unattractive. Also, for configurations with $1/T_{\beta_{as}}$ as close to $1/T_{\beta_{rp}}$ the effects due to N'_r (see figure 251) can be important. A more general approach is to compute a time

MIL-STD-1797A
APPENDIX A

history based on a unit step aileron stick input into Y_{CF} . Physically, this represents the required rudder magnitude for coordination of a unit step aileron control input; that is (from Equations 5 and 6):

$$\delta'_{rp} = Y'_{CF} \delta_{as} = \frac{N'_{\delta_{rp}}}{L'_{\delta_{as}}} \delta_{rp} \quad (14)$$

Utilizing the same response time considerations as in the computation of μ , δ'_{rp} (3) is suggested as the correlating parameter when $|N'_{\delta_{as}}/L'_{\delta_{as}}|$ is small or when the denominator of Y_{CF} is of higher order than the numerator. What specifically constitutes a small value of $N'_{\delta_{as}}/L'_{\delta_{as}}$ has proven to be somewhat difficult to quantify. Reasonably good correlations were found by plotting the $|N'_{\delta_{as}}/L'_{\delta_{as}}| < 0.03$ pilot ratings versus δ'_{rp} (3) as shown on figure 252. More recent experience in utilizing the parameter has revealed that $|N'_{\delta_{as}}/L'_{\delta_{as}}| < 0.07$ results in better correlations. When $|N'_{\delta_{as}}/L'_{\delta_{as}}|$ is between 0.03 and 0.7, both figure 247 and table XLIV should be checked and the most conservative result utilized.

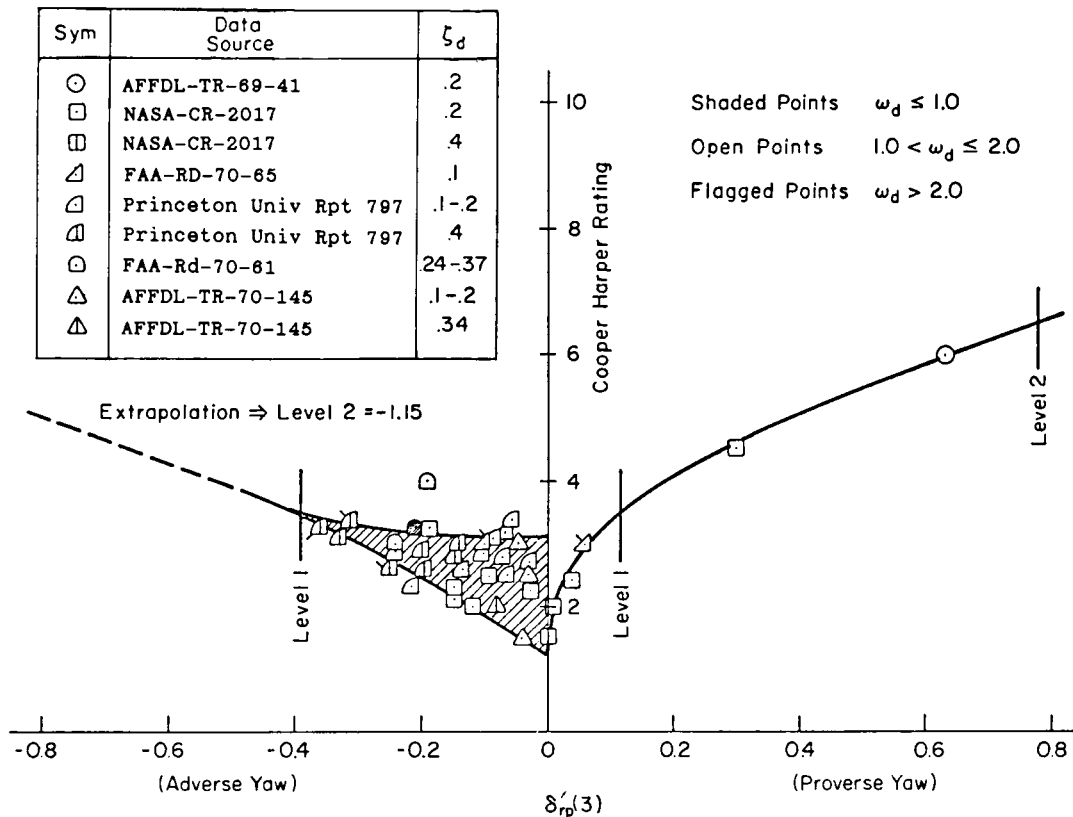

FIGURE 252. Pilot rating correlations when \dot{r}_o/\dot{p}_o is small.

In summary, δ'_{rp} (3) is calculated by obtaining the response of a unit step input into the transfer function Y_{CF} (Equation 3) at $t = 3$ sec. This result is multiplied by $N'_{\delta_{as}}/L'_{\delta_{as}}$ as to give δ'_{rp} (3).

MIL-STD-1797A
APPENDIX A

D. Complex Rudder Shaping

As discussed earlier, reasonable fits of the HOS to the LOS form implicit in equation 9 presume that the required aileron-to-rudder shaping is at least monotonic (or with at most one reversal) in the region of piloted control. This assumes that if the required rudder coordination to a step aileron input is of significant size and non-monotonic in the region of control, pilot opinion will be poor. Since we have been unable to find any configurations having such a non-monotonic shape which have been tested for pilot opinion of heading control, we cannot yet quantify the mismatch effects.

SUPPORTING DATA

A summary of the data sources considered is given in table XLVIII. Each of the data points found to be applicable to heading control (i.e., met the ground rules) is plotted and faired on a logarithmic grid of \dot{r}_o/\dot{p}_o versus μ on figure 253. Only in-flight and moving-base simulator data were considered. With the exception of one or two points the data from all the sources in table XLVIII correlate quite nicely with the criterion (figure 253). The few points that do not fit are rated better than the other data in the same region.

TABLE XLVIII. Summary of current data.

TYPE OF AIRCRAFT SIMULATED	DESCRIPTION OF SIMULATOR	TOTAL REFERENCE	NUMBER OF DATA POINTS	NUMBER OF POINTS MEETING GROUND RULES
Executive jet and military Class II	Variable stability T-33	AFFDL-TR-70-145	84	16
STOL	Variable stability helicopter	Systems Tech Inc., WP-189-3	109	30
General aviation (light aircraft)	Variable stability Navion	FAA-RD-70-65 Part 2	26	6
Jet fighter- carrier approach	Variable stability Navion	Princeton Univ Rpt 797	36	22
Space Shuttle vehicle	6 DOF moving- base	NASA CR-2017	52	52
STOL	3 DOF moving-base	FAA-RD-70-61	8	7

It is significant that the pilot rating correlations are not dependent on the type of aircraft and in fact are shown to be valid for vehicles ranging from light aircraft to fighter, STOL, and Space Shuttle configurations. This result indicates that good heading control characteristics are dependent on a fundamental aspect of piloting technique (aileron-rudder coordination) and that such factors as aircraft size, weight, approach speed, etc. can be neglected for all practical purposes. It is felt that the invariance of ratings with aircraft configuration is related to the pilot's ability to adapt to different situations and to rate accordingly. Finally, the excellent correlations of pilot ratings with the aileron-rudder crossfeed characteristics indicate that the required ruder coordination is indeed a dominant factor in pilot evaluation of heading control.

MIL-STD-1797A
APPENDIX A

The rudder shaping parameter is attractive as a heading control criterion because the handling quality boundaries are easily interpreted in terms of pilot-centered considerations. Its shortcoming is centered about determining parameter values.

A review of the data sources for figure 253 indicates that the requirement as devised is applicable primarily to low-speed flight, and especially to Category C (approach and landing) Flight Phases. Large $N'_{\delta_{as}}$ or N'_p , however, are unlikely at high speed. Further work is necessary in this area to determine any refinements for the other Categories. However, since low-speed flight with a high-gain lateral task defines the most extreme condition for control coordination, the requirement of figure 247 covers the worst cases.

REQUIREMENT LESSONS LEARNED

Figure 254 (from Systems Technology, Inc., TR-1090-1) compares the rudder shaping parameter for several aircraft with the figure 247 requirements. Available pilot rating data for the F-111 with and without adverse yaw compensatory (AYC) support the boundaries. The pilot ratings are from Systems Technology, Inc., TR-199-1, where it is stated that "the F-111B without the adverse yaw compensatory lies in an unacceptable region[The] rudder sequencing criteria...for the F-111 B with and without AYC...are in agreement with the actual ratings it received."

5.6.2 Yaw axis response to roll controller-verification.

Verification shall be by analysis, simulation and flight test.

VERIFICATION RATIONALE(5.6.2)

To determine sideslip excursions, small step roll commands are called for in straight flight and in steady turns. To determine k, rolls are to be made with rudder use according to 4.5.8. The verification of 5.6.2, however, calls for rudder-pedals-fixed rolls from turns. With powered controls, generally there will be no difference here between controls fixed and controls free.

Note from 3.4.6 that AR is the total excursion during the stated time period. Thus if β reverses during that time, the sum of right and left excursion magnitudes is called for.

Clearly, application of the rudder shaping criterion can only be through analysis, necessitating a good analytical model of the numerators of the augmented aircraft. With these, application of the criterion is straightforward. Values derived from wind-tunnel tests and estimates should be updated or verified by flight-test parameter identification wherever roll-induced yawing is a problem.

The rules for application of this shaping criterion are summarized as follows, recalling that $\dot{r}_o/\dot{p}_o = N'_{\delta_{as}}/L'_{\delta_{as}}$:

1. If $|N'_{\delta_{as}}/L'_{\delta_{as}}| < 0.03$, skip to Step 6.
2. Formulate Y_{CF} by taking the ratio of the β/δ_{as} and the β/δ_{rp} transfer functions. For augmented aircraft the transfer functions must include the effects of augmentation: $Y_{CF} = \left(N_{\delta_{as}}^{\beta} / N_{\delta_{rp}}^{\beta} \right)_{aug}$.
3. Remove all roots greater than 6 rad/sec in pairs, keeping the relative numerator and denominator order of Y_{CF} constant. Roots above 6 rad/sec that do not occur in pairs are left unmodified. Set the high-frequency gain of Y_{CF} equal to unity (as in equation 12).

MIL-STD-1797A
APPENDIX A

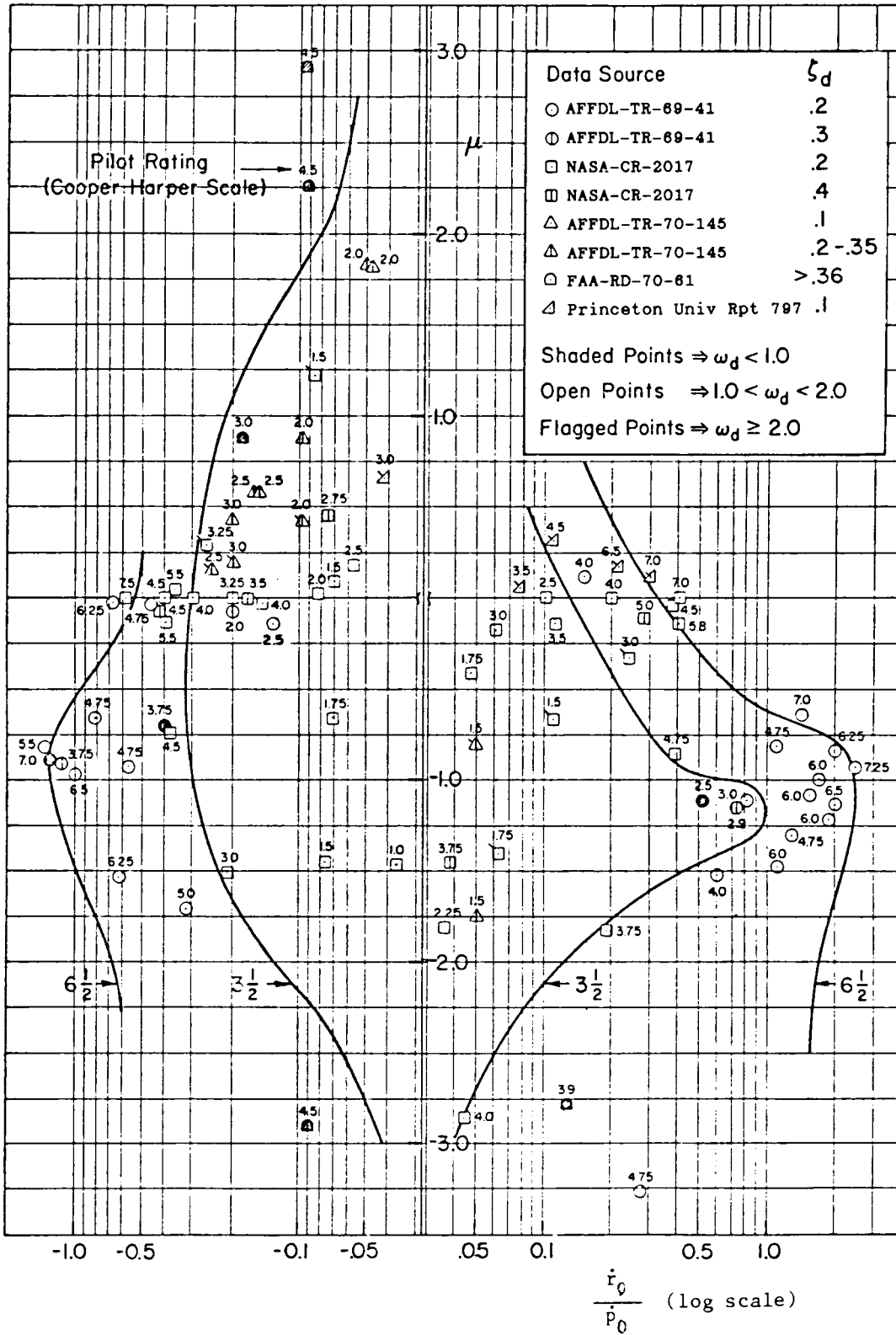

FIGURE 253. Pilot rating correlation with crossfeed parameters.

MIL-STD-1797A
APPENDIX A

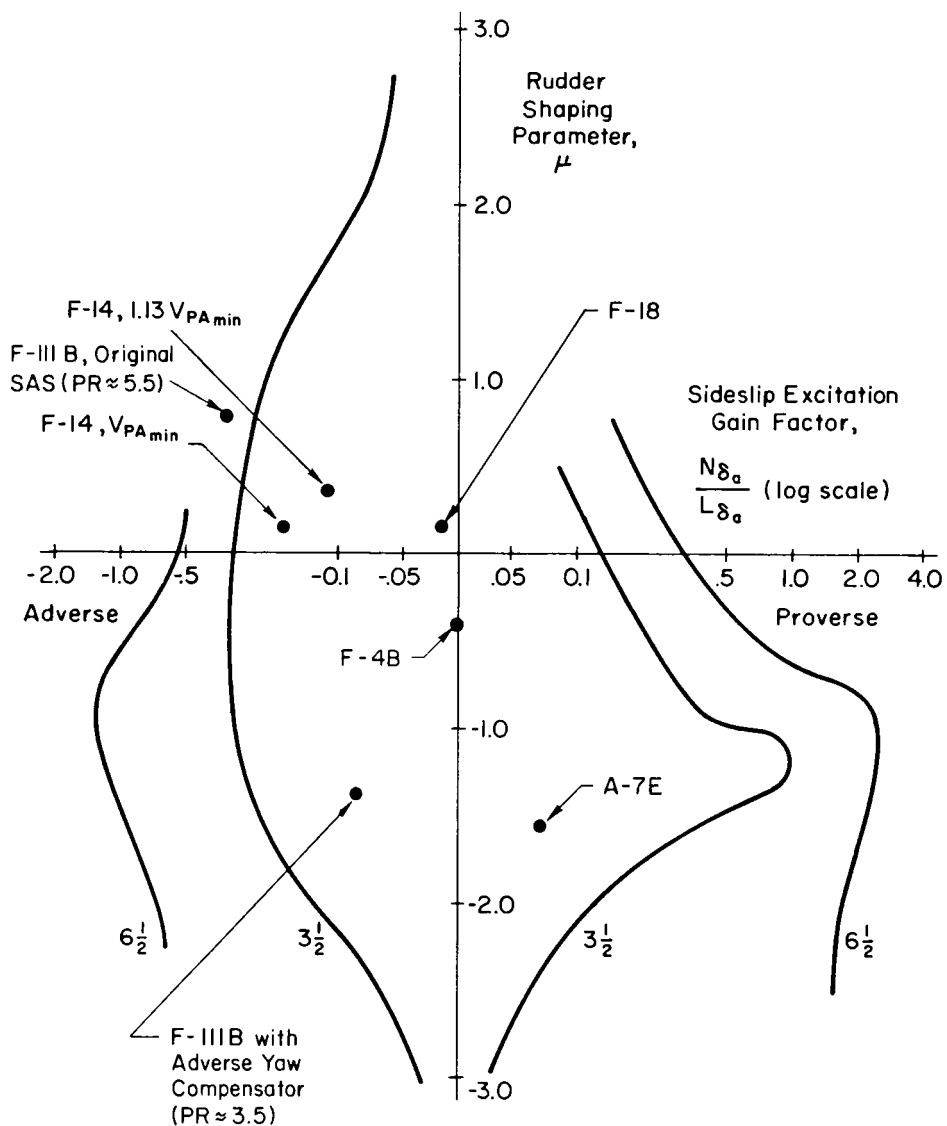

FIGURE 254. Required aileron-rudder sequencing for several operational aircraft, SAS/CAS ON (from Systems Technology, Inc., TR-1090-1).

4. Calculate $\delta_{rp}(3)$ from the time response of Y_{CF} (as modified by step 3) to a unit step input, i.e., $\delta_{rp}(3) = \ell^{-1}\{(1/s)Y_{CF}(s)\}$ evaluated at $t = 3$ sec.
5. Calculate μ as: $\mu = \delta_{rp}(3) - 1$ and plot on figure 247.
6. If $\left| \frac{N'_{\delta_{as}}}{L'_{\delta_{as}}} \right| \leq 0.07$, calculate the normalized rudder required, as follows:
 1. Calculate the magnitude at $t = 3$ sec. of the time response of Y_{CF} (from Step 2) to a unit step input

MIL-STD-1797A
APPENDIX A

2. Multiply the result by $N'_{\delta_{rp}}/L'_{\delta_{as}}$, i.e., $\delta'_{rp}(3) = Y_{CF}(3) \cdot N'_{\delta_{rp}}/L'_{\delta_{as}}$
3. Compare $\delta'_{rp}(3)$ with table XLIV
7. If $0.03 < |N'_{\delta_{as}}/L'_{\delta_{as}}| \leq 0.07$, utilize the more conservative result from steps 5 and 6.
8. If the configuration does not meet the requirements, see figure 249 and table XLVII to determine the type of expected piloting problems.
9. In the end, the transfer functions should be identified from flight data.

VERIFICATION GUIDANCE

The flight testing to obtain $\Delta\beta$ and ϕ_t command should cover the range of operational altitudes and service speeds. As with roll rate oscillations (4.5.1.4), the critical flight conditions for compliance with this requirement should in general become apparent during the roll performance testing of 4.5.5.1. The most important flight conditions for compliance demonstration of either alternative are those with low $|\phi/\beta|_d$, less than 6.

An approximation for $|\phi/\beta|_d$ is

$$\left| \frac{\phi}{\beta} \right|_d \approx \left[\frac{(L'_\beta + Y_\beta L'_r)^2 + 2\zeta_d \omega_d L'_r (L'_\beta + Y_\beta L'_r) + \omega_d^2 L_r'^2}{\omega_d^2 [L_p'^2 + 2\zeta_d \omega_d L_p' + \omega_d^2]} \right]^{1/2} \approx$$

$$\frac{k_z^2 C'_{\ell_\beta} \left[1 - \frac{\rho g b}{4(W/S)} \left[C_{y_\beta} + \frac{1}{2k_z^2} C'_{n_r} - \frac{k_z^2 C'_{\ell_\beta}}{k_x^2 C'_{n_\beta}} \left(C_{L_1} - \frac{1}{2k_z^2} C'_{n_p} \right) \right] \frac{C'_{\ell_r}}{C'_{\ell_\beta}} + \frac{\rho g b}{8(W/S) k_z^2} \left(\frac{C'_{\ell_r}}{C'_{\ell_\beta}} \right)^2 C'_{n_\beta} \right]}{k_x^2 C'_{n_\beta} \left[1 - \frac{\rho g b}{4(W/S) k_x^2} \left[C_{y_\beta} + \frac{1}{2k_z^2} C'_{n_r} - \frac{k_z^2 C'_{\ell_\beta}}{k_x^2 C'_{n_\beta}} \left(C_{L_1} - \frac{1}{2k_z^2} C'_{n_p} \right) \right] \frac{C'_{\ell_p}}{C'_{n_\beta}} + \frac{\rho g b}{8(W/S) k_x^2} \frac{C'_{\ell_p}}{C'_{n_\beta}} \right]} \right]^{1/2}$$

VERIFICATION LESSONS LEARNED

MIL-STD-1797A
APPENDIX A

4.6.3 Pilot-induced yaw oscillations.

There shall be no tendency for sustained or uncontrollable yaw oscillations resulting from efforts of the pilot to control the aircraft in the air or on the ground. Specifically, _____.

REQUIREMENT RATIONALE (4.6.3)

This requirement, in addition to the general requirement of 4.1.11.6, is inserted to provide more specific criteria for any task that might involve high-bandwidth control in yaw or lateral acceleration. An example might be yaw pointing for fine tracking.

REQUIREMENT GUIDANCE

The related MIL-F-8785C requirement is paragraph 3.3.3.

Due to the lack of a reliable quantitative measure, the requirement is written in terms of subjective evaluations. It is of course hoped that meeting the (other) quantitative requirements of this standard will prevent a lateral PIO. This requirement is identical to the roll-axis requirement of 4.5.2.

This requirement should apply to all flight conditions and tasks, and to all Levels, since zero or negative closed-loop damping is to be avoided under any flight condition or failure state. High-bandwidth yaw-control tasks are uncommon. The dynamic yaw response requirement (4.6.2.1) is designed to account for the need of rudder pedal in rolling, but may not cover all contingencies. Some direct sideforce modes may involve high-bandwidth yaw control; see AFWAL-TR-81-3027 and Sammonds, et al., for example.

REQUIREMENT LESSONS LEARNED

The pitch-axis PIO requirement, 4.2.2, discusses some causes of PIOs. Factors known to contribute to lateral-directional PIOs are large effective or equivalent time delays, excessive friction or hysteresis in the flight control system, and the " ω_ψ/ω_d " effect described at length in AFFDL-TR-69-72 (See 4.5.1.4 discussion). Depending upon the cause, ground-based simulation may or may not prove a useful investigation technique -- often it does not.

5.6.3 Pilot-induced yaw oscillations-verification.

Verification shall be by analysis, simulation and flight test.

VERIFICATION RATIONALE (5.6.3)

A precision closed-loop task, performed aggressively, is needed.

VERIFICATION GUIDANCE

The existence of a PIO tendency is difficult to assess. Therefore, no specific flight conditions or tasks are recommended, though a high-stress task such as approach and landing with a lateral offset, terrain following, air-to-ground tracking, or in-flight refueling (receiver) may reveal PIO proneness.

VERIFICATION LESSONS LEARNED

MIL-STD-1797A
APPENDIX A

4.6.4 Yaw axis control for takeoff and landing in crosswinds.

It shall be possible to take off and land with normal pilot skill and technique in 90 deg crosswinds from either side, for velocities up to _____.

REQUIREMENT RATIONALE (4.6.4)

This requirement assures good yaw-axis flying qualities in crosswind takeoffs and landings.

REQUIREMENT GUIDANCE

The related MIL-F-8785C requirement is paragraph 3.3.7.

Recommended crosswind values are given in table XLIX. Either roll or yaw control may be critical, depending upon the aircraft design.

TABLE XLIX. Recommended minimum crosswind velocity requirements.

LEVEL	CLASS	CROSSWIND
1 and 2	I	20 kt
	II, III, and IV	30 kt
	Water-based aircraft	20 kt
3	All	One half the values for Levels 1 and 2

The crosswind specified herein will affect not only this requirement, but also the asymmetric thrust (4.6.5.1), roll control power (4.5.6 and 4.5.8.3), and force (4.5.9.5.3), yaw control power (4.6.6.1) and force (4.6.7.4) requirements, all of which should be reviewed at the same time. In addition, the identical requirement for the roll axis (4.5.6) should be considered.

The side-load capacity of the landing gear is normally intended to allow for the expected dispersion in crab angle at touchdown, rather than to allow keeping much crab intentionally. Crosswind landing gear of one sort or another is a design option, of course, but taxiing must not be made too difficult.

Both crabbing and sideslipping techniques have been used effectively for landing approach. With sideslip, the aircraft heading with respect to the runway is small; with crabbing, a timely rudder kick (supplemented if necessary by aileron) must reduce the crab angle to a small value at touchdown. Landing in a level, crabbed attitude, the main-gear friction force gives a stabilizing, restoring moment for a nose-gear configuration.

Appendix II of AFFDL-TR-69-72 presents a survey of wind data from which the values were derived. While the "requirement could be relaxed to 25 knots and still achieve at least 99.5 percent operational effectiveness," specific airfields such as the Azores are more troubled by crosswinds. Also the values given are averages over one-minute intervals (at about 15 feet height), taken hourly over a 5 to 10 year period. "There are large time and space variations in wind speed and terrain features exert a large influence "

The SAE ARP 842B crosswind is 30 percent of $V_S(L)$ or 40 knots, half of that when there are two failures. One Air Force meteorologist has commented that 35 knots is about as much crosswind as is ever seen.

MIL-STD-1797A
APPENDIX A

REQUIREMENT LESSONS LEARNED

On the ground, other factors in addition to aircraft aerodynamics enter: acceleration/deceleration, symmetric and differential braking, nose-wheel steering, thrust reversing, and any drag parachute. The capabilities and limitations of all these factors play a part. Drag chutes can be particularly troublesome in a crosswind after touchdown. Keeping the nose high for aerodynamic braking keeps down the load on the main gear, thus limiting the effectiveness of differential braking.

From "Reengined KC-135 Shows Performance Gains in Test":

Changes in the nose-wheel steering system on the KC-135R also have been evaluated. Pilots said the combined rudder pedals and "tiller" steering are superior to the small hand wheel used on the KC-135A, particularly during crosswind takeoffs and landings. Takeoff procedures used in the older KC-135A required the pilot to steer the aircraft with his left hand via a small hand wheel, keeping his right hand on the control column yoke. The copilot operates the throttles until the aircraft reaches rudder effectiveness speed and the nosewheel steering control is no longer needed for directional control. At that point, the pilot switches his left hand to the control yoke and his right hand on the throttle quadrant.

By connecting the nosewheel steering to the rudder pedals on the KC-135R, the pilot can control the aircraft's direction with his feet, simplifying normal and crosswind takeoffs. A tiller has replaced the old nosewheel steering control wheel and is used for maneuvering into and out of ramp parking spaces.

5.6.4 Yaw axis control for takeoff and landing in crosswinds-verification.

Verification shall be by analysis, simulation and flight test.

VERIFICATION RATIONALE (5.6.4)

Flight tests must deal with crosswinds as they come during the program. Further, flight testing in 90 degree crosswinds of the specified velocity may be unacceptably hazardous for Level 2 and 3 operations, especially with the gustiness that often accompanies winds of that magnitude. Thus, buildups to large crosswinds are advisable, with some use of flight-validated simulation. Some indication of aircraft crosswind capabilities can be obtained from tests at altitude or low approaches, and crosswind evaluations can be carried as alternate flight cards for target of opportunity testing.

VERIFICATION GUIDANCE

For crabbing and sideslipping see 5.5.8.3 guidance. For bank angle and control deflections in steady sideslips see 5.6.1.2 guidance.

The rudder-pedal-to-aileron crossfeed to decrab with $\dot{p} = 0$ is

$$-\delta_a / \delta_{rp} = C'_{\ell_{\delta_r}} / C'_{\ell_{\delta_a}}$$

so that

$$\dot{r}_o = \left(1 - \frac{C'_{n_{\delta_a}} C'_{\ell_{\delta_r}}}{C'_{\ell_{\delta_a}} C'_{n_{\delta_r}}} \right) \cdot \frac{g}{k_z^2 b C_{L_1}} \cdot \delta_r$$

MIL-STD-1797A
APPENDIX A

and the time to decrab is roughly

$$\Delta t \doteq \sqrt{2\Delta\psi / \dot{r}_o}$$

using step rudder and aileron inputs.

On the ground, directional stability is influenced by dihedral effect. The rolling moment generated by sideslip loads the downwind landing gear, tending to roll the aircraft about it. A wide main-gear track helps a lot.

VERIFICATION LESSONS LEARNED

4.6.5 Yaw axis response to other inputs

4.6.5.1 Yaw axis response to asymmetric thrust.

Asymmetric loss of thrust may be caused by many factors including engine failure, inlet unstart, propeller failure or propeller-drive failure. The requirements apply for the appropriate Flight Phases when any single failure or malperformance of the propulsive system, including inlet, exhaust, engines, propellers, or drives causes loss of thrust on one or more engines or propellers, considering also the effect of the failure or malperformance on all subsystems powered or driven by the failed propulsive system. It shall be possible for the pilot to maintain directional control of the aircraft following a loss of thrust from the most critical propulsive source, allowing a realistic time delay of _____ seconds, as follows:

- Takeoff run: During the takeoff run it shall be possible to maintain a straight path on the takeoff surface without deviations of more than _____ ft. from the path originally intended, following sudden asymmetric loss of thrust. For the continued takeoff, the requirement shall be met when thrust is lost at speeds from the refusal speed (based on the shortest runway from which the aircraft is designed to operate) to the maximum takeoff speed, with takeoff thrust maintained on the operative engine(s); without depending upon release of the pitch, roll, yaw or throttle controls; and using only controls not dependent upon friction against the takeoff surface. For the aborted takeoff, the requirement shall be met at all speeds below the maximum takeoff speed; however, additional controls such as nose wheel steering and differential braking may be used. Automatic devices that normally operate in the event of a thrust failure may be used in either case
- Airborne: After lift-off it shall be possible without a change in selected configuration to achieve straight flight following the critical sudden asymmetric loss of thrust at speeds from $V_{\min}(\text{TO})$ to $V_{\max}(\text{TO})$, and thereafter to maintain straight flight throughout the climb-out and to perform 20-degree-banked turns with and against the inoperative propulsive unit. Automatic devices that normally operate in the event of a thrust failure may be used, and for straight flight the aircraft may be banked up to 5 degrees away from the inoperative engine
- Waveoff/go-around: At any airspeed down to $V_{\min}(\text{L})$ it shall be possible to achieve and maintain steady, straight flight with waveoff (go-around) thrust on the remaining engines following sudden asymmetric loss of thrust from the most critical factor. Configuration changes within the capability of the crew while retaining control of the aircraft, and automatic devices that normally operate in the event of a propulsion failure, may be used
- Crosswinds: The aircraft response requirements for asymmetric thrust in takeoff and landing apply in the crosswinds of 4.6.4 from the adverse direction
- General: The static directional stability shall be such that at all speeds above _____, with the critical asymmetric loss of thrust while the other engine(s) develop(s) normal rated thrust, the aircraft with yaw control pedals free may be balanced directionally in steady straight flight. The trim settings shall be those required for wings-level straight flight prior to the failure.

REQUIREMENT RATIONALE (4.6.5.1)

The transient and steady-state effects of asymmetric thrust must be limited to amounts which can be compensated by pilot control action.

MIL-STD-1797A
APPENDIX A

REQUIREMENT GUIDANCE

The corresponding MIL-F-8785C requirements are paragraphs 3.3.9, 3.3.9.1, 3.3.9.2, 3.3.9.3 and 3.3.9.4.

Recommended values for runway operation:

Minimum time delay:	1 second
Maximum path deviation during takeoff:	30 ft
Minimum speed, yaw controls free:	1.4 V_{min}

Considering variations in pilot alertness to possible failure, 2 seconds may be a more representative time delay. One second should be regarded as an absolute minimum. Also consult 4.1.11.4 guidance for realistic time delay. For operation at forward bases, narrower runways may have to be a design consideration in combination with the main-gear track.

This requirement contains portions of several paragraphs from MIL-F-8785C. It assures directional control by the pilot under adverse conditions (i.e., crosswinds), and insures a match between upsetting yawing moments due to asymmetric thrust and restoring moments from static directional stability. The requirement for adequate control of the ground path insures that, following loss of thrust during the takeoff run, the pilot can either safely abort or safely continue the takeoff. Similarly, the requirement insures that following thrust loss after takeoff the pilot can safely go around or continue climbout. The intent is that $V_{0min}(TO)$ normally should be set by other considerations and adequate control provided down to that speed. Five degrees is about the greatest bank angle possible without significantly reducing the vertical component of lift.

A requirement for turn capability, similar to FAR 25.147(c), addresses the need to ensure maneuvering capability in airport environments to avoid obstacles that become a threat due to the heading change likely incurred with the loss of an engine.

The requirement with rudder pedals free is intended to preclude the consequences of stalling the vertical tail in case of an engine failure. Larger bank and sideslip angles generally will be needed.

4.6.6.2 has an additional requirement on a second propulsive failure. Related requirements on control power and forces are 4.5.8.4, 4.5.9.5.5, 4.6.6.2, and 4.6.7.8.

Failure of any automatic compensation device is a consideration. A rational ground-rule would be to include the probability of such failure in the calculations for 4.1.7.3 or 4.9.4 by assuming a probability of 1 that the critical engine failure occurs, and adding any failures which result in nuisance actuation of the device.

REQUIREMENT LESSONS LEARNED

In B-1B flight testing it was found that other alternatives to the 5-degree bank angle limitation, such as reducing the asymmetry or accelerating, were acceptable.

5.6.5 Yaw axis response to other inputs-verification

5.6.5.1 Yaw axis response to asymmetric thrust-verification.

Verification shall be by analysis, simulation and flight test.

VERIFICATION RATIONALE (5.6-5.1)

Simulated engine failures must be performed in flight, covering at least the critical conditions specified by the procuring activity and the contractor, and covering the range of service speed and altitude for the pertinent Flight Phases. Fuel cutoff is a representative way to simulate many critical propulsion failures.

MIL-STD-1797A
APPENDIX A

Any limitations imposed by this requirement must be observed during the entire flight-test program, including demonstration of compliance with performance requirements.

Generally, all the possible consequences of propulsion system failures must be considered. For example, inlet unstart may cause a disturbance in all axes. Another kind of failure is represented by damage to other parts of the aircraft caused by thrown turbine blades: for example, hydraulic lines should be routed (or enough armor used) so that thrown engine, fan, or propeller parts cannot sever all hydraulic systems needed for flight control (Analysis and simulation, rather than flight test, are of course in order for such considerations). At high speeds, a structural limit may be the critical factor.

VERIFICATION GUIDANCE

Of primary importance in applying this requirement is choice of the most critical flight conditions. From a safety-of-flight standpoint, the most sensitive airborne condition in most cases should be at V_{MC} , the airborne minimum control speed. The following excerpt from FAR Part 25 (paragraph 25.149) serves as a reasonable guideline for designing for V_{MC} :

(b) V_{MC} is the calibrated airspeed, at which, when the critical engine is suddenly made inoperative, it is possible to recover control of the airplane with that engine still inoperative, and maintain straight flight either with zero yaw or, at the option of the applicant, with an angle of bank of not more than 5 degrees.

(c) V_{MC} may not exceed $1.2 V_S$ with --

- (1) Maximum available takeoff power or thrust on the engines;
- (2) The most unfavorable center of gravity;
- (3) The airplane trimmed for takeoff;
- (4) The maximum sea level takeoff weight (or any lesser weight necessary to show V_{MC});
- (5) The airplane in the most critical takeoff configuration existing along the flight path after the airplane becomes airborne, except with the landing gear retracted; and
- (6) The airplane airborne and the ground effect negligible; and
- (7) If applicable, the propeller of the inoperative engine --
 - (i) Windmilling;
 - (ii) In the most probable position for the specific design of the propeller control; or
 - (iii) Feathered, if the airplane has an automatic feathering device...

Except for some extreme wartime situations, aircraft operations will be limited to conditions deemed safe in the event of an engine failure.

For equilibrium at any given bank angle ϕ , after a thrust change ΔT .

MIL-STD-1797A
APPENDIX A

$$\beta = \frac{-[C_{L_1}\phi + C_y(\Delta T)] \left[1 - \frac{C_{n_{\delta_a}} C_{\ell_{\delta_r}}}{C_{\ell_{\delta_a}} C_{n_{\delta_r}}} \right] + \frac{C_{y_{\delta_r}}}{C_{n_{\delta_r}}} \left[C_n(\Delta T) \left(1 - \frac{C_{n_{\delta_a}} C_{\ell_{\delta_r}}}{C_{\ell_{\delta_a}} C_{n_{\delta_r}}} \right) - C_\ell(\Delta T) \left(\frac{C_{n_{\delta_a}}}{C_{\ell_{\delta_a}}} - \frac{C_{y_{\delta_a}} C_{n_{\delta_r}}}{C_{\ell_{\delta_a}} C_{y_{\delta_r}}} \right) \right]}{C_{y_\beta} \left(1 - \frac{C_{n_{\delta_a}} C_{\ell_{\delta_r}}}{C_{\ell_{\delta_a}} C_{n_{\delta_r}}} \right) - C_{n_\beta} \frac{C_{y_{\delta_r}}}{C_{n_{\delta_r}}} \left(1 - \frac{C_{n_{\delta_a}} C_{\ell_\beta}}{C_{\ell_{\delta_a}} C_{n_\beta}} \right) - \frac{C_{y_{\delta_a}}}{C_{\ell_{\delta_a}}} \left(C_{\ell_\beta} - \frac{C_{\ell_{\delta_r}}}{C_{n_{\delta_r}}} C_{n_\beta} \right)}$$

$$\approx \frac{-C_{L_1}\phi + \frac{C_{y_{\delta_r}}}{C_{n_{\delta_r}}} \left[C_n(\Delta T) \left(1 - \frac{C_{n_{\delta_a}} C_{\ell_{\delta_r}}}{C_{\ell_{\delta_a}} C_{n_{\delta_r}}} \right) \right]}{C_{y_\beta} - \frac{C_{y_{\delta_r}}}{C_{n_{\delta_r}}} C_{n_\beta} \left(1 - \frac{C_{n_{\delta_a}} C_{\ell_\beta}}{C_{\ell_{\delta_a}} C_{n_\beta}} \right)}$$

$$\delta_r = \frac{-C_{n_\beta} \left(1 - \frac{C_{n_{\delta_a}} C_{\ell_\beta}}{C_{\ell_{\delta_a}} C_{n_\beta}} \right) \beta - C_n(\Delta T) + \frac{C_{n_{\delta_a}}}{C_{\ell_{\delta_a}}} C_\ell(\Delta T)}{C_{n_{\delta_r}} \left(1 - \frac{C_{n_{\delta_a}} C_{\ell_{\delta_r}}}{C_{\ell_{\delta_a}} C_{n_{\delta_r}}} \right)}$$

For δ_a , see 5.5.8.4 Guidance.

More approximately yet, when $C_n(\Delta T) = -y_T \Delta T$ and $C_\ell(\Delta T) = 0$, derivatives are invariant with angle of attack, and rudder control for static balance is critical, the airborne minimum control speed is given by

$$V_{MC} = 17.2 \cdot \sqrt{\left[\frac{-0.0873(W/S) + \frac{y_T}{b} \cdot \frac{\Delta T}{S} \cdot \frac{C_{y_\beta}}{C_{n_\beta} \left(1 - \frac{C_{n_{\delta_a}} C_{\ell_\beta}}{C_{\ell_{\delta_a}} C_{n_\beta}} \right)}}{\left(\frac{C_{y_\beta} C_{n_{\delta_r}}}{C_{n_\beta} \left(1 - \frac{C_{n_{\delta_a}} C_{\ell_\beta}}{C_{\ell_{\delta_a}} C_{n_\beta}} \right)} - C_{y_{\delta_r}} \right) \delta_{r_{max}}} \right]} \quad \begin{matrix} \text{kt} \\ \text{EAS} \end{matrix}$$

with $\phi = 5$ deg in the failed-engine-up sense (For $\phi = 0$, delete the W/S term). Either force or deflection limits may determine $\delta_{r_{max}}$.

Yaw controls free: with linear rudder hinge moments,

MIL-STD-1797A
APPENDIX A

$$\beta = \frac{-C_n(\Delta T)}{C_{n\beta}^*} \left(\frac{1 - \frac{C_{n\delta_a} C_\ell(\Delta T)}{C_{\ell\delta_a} C_n(\Delta T)}}{1 - \frac{C_{n\delta_a} C_{\ell\beta}^*}{C_{\ell\delta_a} C_{n\beta}^*}} \right)$$

$$\delta_a = \frac{\frac{C_{\ell\beta}^*}{C_{n\beta}^*} C_n(\Delta T) - C_\ell(\Delta T)}{C_{\ell\delta_a} \left(1 - \frac{C_{n\delta_a} C_{\ell\beta}^*}{C_{\ell\delta_a} C_{n\beta}^*} \right)}$$

$$\sin \phi = \left(\frac{1}{C_{L1}} \right) \left[-C_y(\Delta T) + \left(\frac{1 - \frac{C_{y\delta_a} C_{\ell\beta}^*}{C_{\ell\delta_a} C_{n\beta}^*}}{1 - \frac{C_{n\delta_a} C_{\ell\beta}^*}{C_{\ell\delta_a} C_{n\beta}^*}} \right) \frac{C_{y\beta}^*}{C_{n\beta}^*} C_n(\Delta T) + \left(\frac{C_{y\delta_a} - \frac{C_{y\beta}^*}{C_{n\beta}^*} C_{n\delta_a}}{1 - \frac{C_{n\delta_a} C_{\ell\beta}^*}{C_{\ell\delta_a} C_{n\beta}^*}} \right) \frac{C_\ell(\Delta T)}{C_{\ell\delta_a}} \right]$$

where

$$C_{y\beta}^* = C_{y\beta} - C_{y\delta_r} C_{hr\beta} / C_{hr\delta_r}$$

$$C_{n\beta}^* = C_{n\beta} - C_{n\delta_r} C_{hr\beta} / C_{hr\delta_r}$$

$$C_{\ell\beta}^* = C_{\ell\beta} - C_{\ell\delta_r} C_{hr\beta} / C_{hr\delta_r}$$

VERIFICATION LESSONS LEARNED

To minimize the danger (in event of another failure) of flight testing near the ground, tests might be conducted down to the minimum safe attitude, extrapolated to sea level - accounting for any derivative changes with angle of attack or thrust coefficient - and spot checked at the lower altitude. This technique has worked well with some airplanes, but not so well for the B-1.

MIL-STD-1797A
APPENDIX A

4.6.5.2. Yaw axis response to failures.

With controls free, the yawing motions due to failures shall not exceed _____ for at least _____ seconds following the failure.

REQUIREMENT RATIONALE (4.6.5.2)

This requirement limits the severity of failures on controllability in the yaw axis.

REQUIREMENT GUIDANCE

The related MIL-F-8785C requirements are paragraphs 3.4.8, 3.4.9 and 3.5.5.1.

Recommended values: The yaw excursions should not exceed the following limits for at least 2 seconds following the failure:

Levels 1 and 2 (after failure)	0.5 g incremental lateral acceleration at the pilot's station, except that structural limits shall not be exceeded. In addition, for Category A, lateral excursions of 5 ft.
Level 3 (after failure)	No dangerous attitude or structural limit is reached and no dangerous alteration of the flight path results from which recovery is impossible.

The severity of transients due to the failure must be small enough to allow the pilot to regain control; and, having done so, to operate at least adequately to terminate the mission (this is implied by requiring Level 3 or better flying qualities following any single failure).

REQUIREMENT LESSONS LEARNED

5.6.5.2 Yaw axis response to failures-verification.

Verification shall be by analysis, simulation, and flight test.

VERIFICATION RATIONALE (5.6.5.2)

The test aircraft may need special provisions for introducing specific failures in flight. Analysis or simulations should precede flight tests in order to avoid excessively risky combinations of failure and flight condition.

For those failures and flight conditions judged too hazardous to evaluate in flight, demonstration likely will be by simulation.

VERIFICATION GUIDANCE

Any failures specified under 4.1.7.4 should be evaluated in flight testing at the appropriate critical flight conditions. Other failures and worst-case flight conditions will be found in the failure mode and effect analyses of 4.1.7.3. Adequate motion cues should be available to simulate the acceleration environment with one-to-one fidelity for at least 2 seconds following the failure.

VERIFICATION LESSONS LEARNED

MIL-STD-1797A
APPENDIX A

4.6.5.3 Yaw axis response to configuration or control mode change.

With controls free, the transients resulting from configuration changes or the engagement or disengagement of any portion of the flight control system due to pilot action shall not exceed _____ for at least _____ seconds following the transfer. This requirement applies only for Aircraft Normal States, within the Service Flight Envelope.

REQUIREMENT RATIONALE (4.6.5.3)

Yaw transients due to intentional mode switching must not cause excessive distraction.

REQUIREMENT GUIDANCE

The related requirements of MIL-F-8785C are paragraphs 3.5.6 and 3.5.6.1.

Recommended transient motions (within first 2 seconds following transfer): the lesser of 5 degrees sideslip and the structural limit.

Since the intent of a stability or control augmentation system is to improve the aircraft response characteristics -- whether measured by improved flying qualities or by increased mission effectiveness -- any system which can be chosen by the pilot should not cause noticeable transient motions.

REQUIREMENT LESSONS LEARNED

5.6.5.3 Yaw axis response to configuration or control mode change-verification.

Verification shall be by analysis, simulation and flight test.

VERIFICATION RATIONALE (5.6-5.3)

Limited analytical and ground-based simulation may be used to supplement actual flight testing, especially in the early stages of development; but flight testing is ultimately required.

VERIFICATION GUIDANCE

Flight testing must include the corners of the expected operational envelopes for any control systems (e.g., a SAS for power approach must be switched at the highest and lowest airspeeds for engagement, at low altitudes).

VERIFICATION LESSONS LEARNED

MIL-STD-1797A
APPENDIX A

4.6.6 Yaw axis control power.

Directional stability and control characteristics shall enable the pilot to balance yawing moments and control yaw and sideslip.

REQUIREMENT RATIONALE (4.6.6)

This qualitative requirement is based on the fundamental necessity to establish equilibrium in the yaw axis in the presence of disturbances. Specific requirements are given in 4.6.5.1 through 4.6.5.3.

REQUIREMENT GUIDANCE

The related MIL-F-8785C requirement is paragraph 3.3.5.

Note that some of the limits on yaw axis control forces, subparagraphs under 4.6.7, also effectively specify yaw control power.

The yaw controller must always be sufficiently powerful to overcome any anticipated yawing moment. This requirement allows for directional stability (i. e., $C_{n\dot{\rho}}$) to augment the control power (i.e., $C_{n\delta_{rp}}$).

REQUIREMENT LESSONS LEARNED

5.6.6 Yaw axis control power-verification.

Verification shall be by analysis, simulation and flight test.

VERIFICATION RATIONALE (5.6.6)

Flight testing will be required, emphasizing steady sideslips at all conditions.

VERIFICATION GUIDANCE

The requirement should be applied during all phases of development. Parameters of possible significance are indicated by:

$$\bar{q} S b C_n(\delta r, \delta a, \beta, \delta T, \dot{\beta}, P, R, \alpha, m \dots) = I_{z\dot{r}} - I_{xz} (\dot{\rho} + QR) + (I_y - I_x) PQ$$

VERIFICATION LESSONS LEARNED

MIL-STD-1797A
APPENDIX A

4.6.6.1 Yaw axis control power for takeoff, landing, and taxi.

The following requirements shall be met:

- a. It shall be possible to taxi on a dry surface at any angle to a _____ knot wind.
- b. In the takeoff run, landing rollout, and taxi, yaw control power in conjunction with other normal means of control shall be adequate to maintain a straight path on the ground or other landing surface. This applies to calm air and in crosswinds up to the values specified in 4.6.4, on wet runways, and on _____. For very slippery runways, the requirement need not apply for crosswind components at which the force tending to blow the aircraft off the runway exceeds the opposing tire-runway frictional force with the tires supporting all of the aircraft's weight.
- c. If compliance with (b) is not demonstrated by test under the adverse runway conditions of (b), directional control shall be maintained by use of aerodynamic controls alone at all airspeeds above _____ kt.
- d. Yaw axis control power shall be adequate to develop _____ degrees of sideslip in the power approach.
- e. All carrier-based aircraft shall be capable of maintaining a straight path on the ground without the use of wheel brakes, at airspeeds of 30 knots and above, during takeoffs and landings in a 90-degree crosswind of at least $0.1 V_S(L)$.

REQUIREMENT RATIONALE (4.6.6.1)

This requirement defines yaw control power for operations on or near the ground, accounting for expected crosswinds.

REQUIREMENT GUIDANCE

The related MIL-F-8785C requirements are paragraphs 3.3.7.1, 3.3.7.2, 3.3.7.2.1, 3.3.7.2.2 and 3.3.7.3.

Recommended values:

Wind speeds for taxi:

Class I aircraft:	35 kt
Class II, III, and IV aircraft:	45 kt
Minimum sideslip in power approach:	10 deg
Minimum controllable speeds with aerodynamic controls alone:	
Class IV	50 kt
Others	30 kt

Other runways: snow-packed and icy runways

Application of this requirement as stated is straightforward; however, some caution should be exercised in applying the crosswinds specified in 4.5.6, since actual crosswinds normally include unsteady gusts, and designing to just meet this requirement might not leave a margin for safety in real crosswinds. The crosswinds for taxiing are somewhat higher, since taxiing must be possible in any direction. The closely related roll-axis requirement is 4.5.8.3. Also, see 4.6.4 Guidance.

MIL-STD-1797A
APPENDIX A

REQUIREMENT LESSONS LEARNED

Landing-gear characteristics, for example nose-wheel centering and castering, affect ground handling. Some cross-wind gears have made taxiing difficult.

5.6.6.1 Yaw axis control power for takeoff, landing, and taxi-verification.

Verification shall be by analysis, simulation and flight test.

VERIFICATION RATIONALE (5.6.6.1)

As with all requirements on control power, it is desirable to show compliance through actual testing. However, as with all crosswind requirements, suitable conditions can be difficult to find. Operation in some level of crosswind that falls within the maximum specified in 4.5.6 should provide some indication of trends. Careful analysis to extrapolate these results to the limits of this paragraph may then be accepted in lieu of further testing.

VERIFICATION GUIDANCE

An aft center of gravity will put less weight on the nose gear, a consideration for nose-wheel steering. At touchdown, since lifting forces are high, the landing-gear ground reactions may be low; thus it may be necessary to depress the upwind wing as in a steady sideslip to achieve balanced lateral forces.

When lateral control is lost at lower speeds and it is no longer possible to hold the wings level, the resulting lateral component of lift may cause a large unbalance of lateral forces. Although it may be possible to maintain heading, the aircraft skids downwind. Application of upwind brake to counteract the skidding may or may not be successful. A full analysis gets rather involved, but AFFDL-TR-65-218 gives some simplified equations. Also, see 5.6.4 Guidance.

VERIFICATION LESSONS LEARNED

MIL-STD-1797A
APPENDIX A

4.6.6.2 Yaw axis control power for asymmetric thrust.

Yaw control power shall be sufficient to meet the requirements of 4.6.5.1. In addition, at the one-engine-out speed for maximum range with any engine initially failed, upon failure of the most critical remaining engine the yaw control power shall be adequate to stop the transient motion and thereafter to maintain straight flight from that speed to the speed for maximum range with both engines failed. Further, it shall be possible to effect a safe recovery at any service speed above $V_{o_{min}}$ (CL) following sudden simultaneous failure of the two critical engines.

REQUIREMENT RATIONALE (4.6.6.2)

This requirement provides an additional assurance of flight safety, including the more remote but possible event of two sequential or simultaneous propulsive failures.

REQUIREMENT GUIDANCE

The related MIL-F-8785C requirements are paragraphs 3.3.9 through 3.3.9.5.

The Federal Aviation Regulations, among other sets of requirements, have similar requirements.

REQUIREMENT LESSONS LEARNED

5.6.6.2 Yaw axis control power for asymmetric thrust-verification.

Verification shall be by analysis, simulation and flight test.

VERIFICATION RATIONALE (5.6.6.2)

The specialized nature of the requirement, as well as the general, qualitative terms in which it is worded, makes it straightforward to apply. Buildups may be advisable in flight testing.

VERIFICATION GUIDANCE

Flight testing at altitudes covering the operational envelope will be at conditions stated by the requirements, e.g., for two engines out the airspeeds will be either speed for maximum range with one engine out or representative speeds at and above $V_{o_{min}}$ (CL). At high speeds, structural limits may govern the allowable excursions.

VERIFICATION LESSONS LEARNED

MIL-STD-1797A
APPENDIX A

4.6.6.3 Yaw axis control power with asymmetric loading.

Yaw control power shall be sufficient to meet 4.5.8.6.

REQUIREMENT RATIONALE (4.6.6.3)

This requirement assures adequate yaw control power to compensate for any specified condition of asymmetric loading.

REQUIREMENT GUIDANCE

The related MIL-F-8785C requirement is paragraph 3.3.5.1.1.

This requirement is intended to be applied in conjunction with 4.6.7.5. 4.5.8.6 calls for ability to maintain a straight path throughout the Operational Flight Envelope with all the asymmetric loadings called out in the contract.

REQUIREMENT LESSONS LEARNED

5.6.6.3 Yaw axis control power with asymmetric loading-verification.

Verification shall be by analysis, simulation and flight test.

VERIFICATION RATIONALE (5.6.6.3)

Yaw control should be noted during verification of compliance with 4.5.8.6.

VERIFICATION GUIDANCE

Low airspeed generally will be critical.

VERIFICATION LESSONS LEARNED

MIL-STD-1797A
APPENDIX A

4.6.7 Yaw axis control forces.

Sensitivity to yaw control pedal forces shall be sufficiently high that directional control and force requirements can be met and satisfactory coordination can be achieved without unduly high control forces, yet sufficiently low that occasional improperly coordinated control inputs will not cause a degradation in flying qualities Level.

REQUIREMENT RATIONALE (4.6.7)

This qualitative requirement is a preliminary to the quantitative requirements that follow.

REQUIREMENT GUIDANCE

The related MIL-F-8785C requirement is paragraph 3.3.5.

The quantitative rudder pedal force requirements of this Standard are only on maximum forces, not on gradients. There are little data for defining a quantitative requirement on yaw control force/position gradients; and this issue has seldom been critical.

The qualitative gradient requirement, together with the quantitative force limits, are thought sufficient. From the basic nature of this requirement it is clear that it should be easily met by proper control design in the early stages of development. Note that in specifying pedal force limits for certain operations, the requirements that follow also specify yaw control effectiveness.

REQUIREMENT LESSONS LEARNED

5.6.7 Yaw axis control forces-verification.

Verification shall be by analysis, simulation and flight test.

VERIFICATION RATIONALE (5.6.7)

In general, flight testing for compliance with the rest of the yaw axis requirements should reveal any problems with meeting this requirement. Special attention should be given when testing for compliance with the maximum force requirements that follow, since these can be considered subsets of this general statement.

VERIFICATION GUIDANCE

See Verification Guidance for the subparagraphs that follow.

VERIFICATION LESSONS LEARNED

MIL-STD-1797A
APPENDIX A

4.6.7.1 Yaw axis control force limits in rolling maneuvers.

In the maneuvers described in 4.5.8.1, directional-control effectiveness shall be adequate to maintain zero sideslip with pedal force not greater than _____ lb.

REQUIREMENT RATIONALE (4.6.7.1)

This requirement is aimed at insuring adequate yaw-control effectiveness for coordination during rapid turn entries and exits as well as during steady rolls, without extreme rudder-pedal forces.

REQUIREMENT GUIDANCE

The related MIL-F-8785C requirement is paragraph 3.3.2.5.

Recommended values:

CLASS	FLIGHT PHASE CATEGORY	LEVEL	MAXIMUM PEDAL FORCE, LB
IV	A	1	50
		2-3	100
IV	B, C	All	100
All others	All	All	100

The coordinated, banked turn is a basic flight maneuver. This requirement is either a companion to 4.6.2 (if the alternative rudder crossfeed requirement is used for roll-sideslip coupling) or the requirement on coordination in turn entry and exit. In the latter case it serves as a control effectiveness requirement as well -- though usually not a critical one. For parametric expressions of the required rudder pedal deflections, see the 4.6.2 guidance.

REQUIREMENT LESSONS LEARNED

5.6.7.1 Yaw control force limits in rolling maneuvers-verification.

Verification shall be by analysis, simulation and flight test.

VERIFICATION RATIONALE (5.6.7.1)

Yaw pedal forces should be recorded during testing for compliance with 4.5.8.1 in which rudder pedals are used to reduce adverse yaw. Analytically, sideslip can be suppressed and the required pedal force and deflection determined.

VERIFICATION GUIDANCE

During tests of roll performance and roll-yaw coupling, any critical flight conditions for this yaw-control requirement will become evident.

VERIFICATION LESSONS LEARNED

MIL-STD-1797A
APPENDIX A

4.6.7.2 Yaw axis control force limits in steady turns.

It shall be possible to maintain steady coordinated turns in either direction, using _____ deg of bank with a pedal force not exceeding _____ lb, with the aircraft trimmed for wings-level straight flight. These requirements constitute Levels 1 and 2.

REQUIREMENT RATIONALE (4.6.7.2)

The object of this requirement is to insure that high yaw pedal forces are not required to be held in steady coordinated turns.

REQUIREMENT GUIDANCE

The related MIL-F-8785C requirement is paragraph 3.3.2.6.

Recommended values:

AIRCRAFT CLASS	BANK ANGLE (DEG)	MAXIMUM PEDAL FORCE (LB)
I, II	45	40
III	30	40
IV	60	40

The maximum allowable pedal forces should be relatively small for banked turns, where the forces may be sustained for some time. Retrimming is undesirable. Not only is it an added workload, but the reference for straight flight is lost. Good design practice would dictate considerably lower forces than these upper limits -- ideally zero.

This requirement applies to Levels 1 and 2 only. It is expected that Level 3 operations would not involve steady, large-bank-angle turns; since, these limits exceed pilots' force capabilities.

A related requirement on roll control in steady turns with yaw control free is 4.5.9.5.1.

REQUIREMENT LESSONS LEARNED

5.6.7.2 Yaw axis control force limits in steady turns-verification.

Verification shall be by analysis, simulation and flight test.

VERIFICATION RATIONALE (5.6.7.2)

Yaw control forces for turn coordination should be recorded at any flight conditions where high forces are noted in the course of the flight test program.

VERIFICATION GUIDANCE

Flight testing at the specified bank angle, at the minimum operational velocity, presents the most potential for large yawing moments.

In a coordinated turn ($n_y = 0$) the equilibrium equations are, for stability axes ($C_{y_{\delta a}}$ is usually negligible).

MIL-STD-1797A
APPENDIX A

$$\begin{bmatrix} C_{y\beta} & 0 & C_{y\delta_r} \\ C_{\ell\beta} & C_{\ell\delta_a} & C_{\ell\delta_r} \\ C_{n\beta} & C_{n\delta_a} & C_{n\delta_r} \end{bmatrix} \begin{pmatrix} \beta \\ \delta_a \\ \delta_r \end{pmatrix} = \frac{g}{V} \cdot \frac{b}{2V} \cdot \sin \phi \cdot \begin{bmatrix} C_{y_p} \sin \theta / \cos \phi - C_{y_r} \cos \theta \\ C_{\ell_p} \sin \theta / \cos \phi - C_{\ell_r} \cos \phi + 2C_{L_1} \cos \theta \sin \phi \tan \phi \left[\left(k_z^2 - k_y^2 \bar{c}^2 / b^2 \right) \cos \theta + k_{xz}^2 \sin \theta / \cos \phi \right] \\ C_{n_p} \sin \theta / \cos \phi - C_{n_r} \cos \theta + 2C_{L_1} \cos \theta \sin \phi \tan \phi \left[\left(k_x^2 - k_y^2 \bar{c}^2 / b^2 \right) \sin \theta / \cos \phi + k_{xz}^2 \cos \theta \right] \end{bmatrix}$$

where

$$C_{L_1} = W / (\bar{q}S), \quad k_x^2 = I_x / (mb^2), \quad k_y^2 = I_y / (m\bar{c}^2), \quad k_z^2 = I_z / (mb^2), \quad k_{xz}^2 = I_{xz} / (mb^2)$$

which can be solved to find β , δ_a and δ_r as functions of Φ , evaluating the aerodynamic and inertial coefficients at the trim angle of attack corresponding to $n_z \doteq \cos \theta / \cos \Phi$. The right-hand side simplifies for $\gamma = 0$. In any case the right-hand column consists of constants corresponding to Φ . Calling the right hand column $(0 \ C_2 \ C_3)^T$ (neglecting C_{y_p} and C_{y_r}):

$$\begin{aligned} \beta &= \frac{gbC_{y\delta_r} \sin \Phi}{2V^2 \Delta} (C_2 C_{n\delta_a} - C_3 C_{\ell\delta_a}) \\ \delta_a &= \frac{gb \sin \Phi}{2V^2 \Delta} [C_2 (C_{y\beta} C_{n\delta_r} - C_{n\beta} C_{y\delta_r}) - C_3 (C_{y\beta} C_{\ell\delta_r} - C_{\ell\beta} C_{y\delta_r})] \\ \delta_r &= \frac{gbC_{y\beta} \sin \Phi}{2V^2 \Delta} (C_3 C_{\ell\delta_a} - C_2 C_{n\delta_a}) \end{aligned}$$

where

$$\Delta = C_{\ell\delta_a} C_{n\delta_r} \left[C_{y\beta} \left(1 - \frac{C_{n\delta_a} C_{\ell\delta_r}}{C_{\ell\delta_a} C_{n\delta_r}} \right) - C_{n\beta} \frac{C_{y\delta_r}}{C_{n\delta_r}} \left(1 - \frac{C_{\ell\beta} C_{n\delta_a}}{C_{n\beta} C_{\ell\delta_a}} \right) \right]$$

For a zero-sideslip turn, such expressions are not available. However, the difference in results will be small. In a turn with $a_y = 0$, sideslip is generally very small except at very low airspeed.

VERIFICATION LESSONS LEARNED

MIL-STD-1797A
APPENDIX A

4.6.7.3 Yaw axis control force limits during speed changes.

When initially trimmed directionally with symmetric power, the trim change with speed shall be such that wings-level straight flight can be maintained over a speed range of ± 30 percent of the trim speed or ± 100 kt equivalent airspeed, whichever is less (except where limited by boundaries of the Service Flight Envelope) with yaw-control-pedal forces not greater than _____ lb without retrimming.

REQUIREMENT RATIONALE (4.6.7.3)

This requirement is included to insure that speed effects on yawing moment are not unduly distracting.

REQUIREMENT GUIDANCE

The related MIL-F-8785C requirement is paragraph 3.3.5.1.

Recommended values:

PROPULSION TYPE	LEVEL	MAXIMUM PEDAL FORCE(LB)
Propeller	1 and 2	100
	3	180
All Others	1 and 2	40
	3	180

The maximum allowable forces are stated by type of propulsion. The large forces associated with sidewash and asymmetric blade loading make a relaxation of the requirement advisable for propeller-driven aircraft. But the stated maximum values (taken from MIL-F-8785C) may be found objectionably large by many pilots and beyond the capability of some.

REQUIREMENT LESSONS LEARNED

5.6.7.3 Yaw axis control force limits during speed changes-verification.

Verification shall be by analysis, simulation and flight test.

VERIFICATION RATIONALE (5.6.7.3)

Acceleration/deceleration runs performed for 4.4.1 can also be used to check compliance with this requirement. Testing should be accomplished in all operational configurations.

VERIFICATION GUIDANCE

Low speed or transonic phenomena may be critical.

VERIFICATION LESSONS LEARNED

MIL-STD-1797A
APPENDIX A

4.6.7.4 Yaw axis control force limits in crosswinds.

It shall be possible to take off and land in the crosswinds specified in 4.6.4 without exceeding the following yaw control forces: _____.

REQUIREMENT RATIONALE (4.6.7.4)

This requirement is included to limit the yaw pedal forces required for crosswind takeoffs and landings to tolerable values.

REQUIREMENT GUIDANCE

The related MIL-F-8785C requirement is paragraph 3.3.7.

Recommended values:

LEVEL	MAXIMUM PEDAL FORCE (LB)
1	100
2 and 3	180

The allowable maximum pedal forces for crosswind operations are somewhat high, but this is a result of the fact that such operations are generally of very short duration.

4.6.4, specifies the crosswind component to be applied for this requirement. The recommended limits are taken directly from MIL-F-1711C, However, they are felt to be quite high for continuous maneuvering and may be excessive for female pilots. It is recommended that the procuring activity consider lower limits on new aircraft. AFAMRL-TR-81-39 shows that of 61 men and 61 women tested in a short-duration (4 second) force test, almost all could exert 180 lb to rudder pedals. However, continuous maneuvering would likely be difficult for male or female pilots.

REQUIREMENT LESSONS LEARNED

5.6.7.4 Yaw axis control force limits in crosswinds-verification.

Verification shall be by analysis, simulation and flight test.

VERIFICATION RATIONALE (5.6.7.4)

Compliance should be demonstrated by performing takeoffs and landings in the actual crosswinds stated in 4.6.4. The use of simulation is not recommended because of the difficulty in developing an accurate model of the landing gear dynamics.

VERIFICATION GUIDANCE

See 5.6.4 Guidance.

VERIFICATION LESSONS LEARNED

MIL-STD-1797A
APPENDIX A

4.6.7.5 Yaw axis control force limits with asymmetric loading.

When initially trimmed directionally with each asymmetric loading specified in 4.1.1 at any speed in the Operational Flight Envelope, it shall be possible to maintain a straight flight path throughout the Operational Flight Envelope with yaw-control-pedal forces not greater than _____ lb without retrimming.

REQUIREMENT RATIONALE (4.6.7.5)

This requirement is included to insure that asymmetric loadings do not result in excessive yaw pedal force demands on the pilot.

REQUIREMENT GUIDANCE

The related MIL-F-8785C requirement is paragraph 3.3.5.1.1.

Recommended values:

LEVEL	MAXIMUM PEDAL FORCE(LB)
1 and 2	100
3	180

Again, these limits are quite high for prolonged application; but then retrimming would be expected. If asymmetric loadings are expected to be encountered regularly, the procuring activity may want to reduce the yaw control force limits. The recommended limits have been taken from MIL-F-8785C and 180 lb seems unreasonably high (see 4.6.7.4).

REQUIREMENT LESSONS LEARNED

5.6.7.5 Yaw axis control force limits with asymmetric loading-verification.

Verification shall be by analysis, simulation and flight test.

VERIFICATION RATIONALE (5.6.7.5)

Flight testing with the aircraft configured as specified in 4.1.1 should be conducted throughout the Operational Envelope.

VERIFICATION GUIDANCE

For internal mass asymmetries, low airspeed is generally critical.

VERIFICATION LESSONS LEARNED

MIL-STD-1797A
APPENDIX A

4.6.7.6 Yaw axis control force limits in dives and pullouts.

Throughout the dives and pullouts of 4.2.8.6.3, yaw-control-pedal forces shall not exceed _____ lb in dives and pullouts to the maximum speeds in the Service Flight Envelope.

REQUIREMENT RATIONALE (4.6.7.6)

Excessive yaw in dives presents both control and structural problems, so any required rudder pedal forces must be within the pilot's capability.

REQUIREMENT GUIDANCE

The related MIL-F-8785C requirement is paragraph 3.3.8.

Recommended values:

PROPULSION TYPE	MAXIMUM PEDAL FORCE (LB)
Propeller	180
All Others	50

Although 4.6.7.3 limits the rudder pedal forces needed to maintain straight flight over this speed range, pullouts may be a more severe test. This relaxed requirement is intended to assure controllability in extreme cases. As for 4.6.7.3, the maximum pedal forces are much larger for propeller-driven aircraft because of torque and slipstream effects. The recommended limits seem unreasonably high for female pilots (see 4.6.7.4).

REQUIREMENT LESSONS LEARNED

5.6.7.6 Yaw axis control force limits in dives and pullouts-verification.

Verification shall be by analysis, simulation and flight test.

VERIFICATION RATIONALE (5.6.7.6)

Check during the dives of 5.2.8.6.3.

VERIFICATION GUIDANCE

See 5.2.8.6.3 guidance.

VERIFICATION LESSONS LEARNED

MIL-STD-1797A
APPENDIX A

4.6.7.7 Yaw axis control force limits for waveoff (go-around).

The response to thrust, configuration and airspeed change shall be such that the pilot can maintain straight flight during waveoff (go-around) initiated at speeds down to VS (PA) with yaw control pedal forces not exceeding _____lb when trimmed at $V_{o_{min}}$ (PA). The preceding requirements apply for Levels 1 and 2. The Level 3 requirement is to maintain straight flight in these conditions with yaw control pedal forces not exceeding _____ lb. Bank angles up to 5 deg are permitted for all Levels.

REQUIREMENT RATIONALE (4.6.7.7)

The possibility of large, transient yaw pedal force being needed on initiation of go-arounds necessitates a limit.

REQUIREMENT GUIDANCE

The related MIL-F-8785C requirement is paragraph 3.3.5.2.

Recommended values:

	MAXIMUM PEDAL FORCE (LB)
Levels 1 and 2	
Propeller-driven Class IV, and all propeller-driven carrier-based aircraft	100
All others	40
Level 3	
All.....	180

Pedal forces tend to be very high during a go-around due to the large change in configuration that occurs between the approach and go-around. The requirement values were taken directly from MIL-F-8785C. To accommodate female pilots, and even males, lower limits are warranted if appropriate data can be made available.

This very important requirement should be applied for all aircraft, at various weights and loadings, to assure that go-arounds will not overtax the pilot at a very stressful, busy time.

REQUIREMENT LESSONS LEARNED

5.6.7.7 Yaw axis control force limits for waveoff (go-around)-verification.

Verification shall be by analysis, simulation and flight test.

VERIFICATION RATIONALE (5.6.7.7)

This is one of several flying qualities to be checked during go-arounds. Go-arounds may be simulated at a safe (but low) altitude, covering the speed range specified.

VERIFICATION GUIDANCE

Aft center of gravity, low airspeed, low weight and high airspeed, high weight should be checked.

VERIFICATION LESSONS LEARNED

MIL-STD-1797A
APPENDIX A

4.6.7.8 Yaw axis control force limits for asymmetric thrust during, takeoff.

The following requirements shall be met:

Takeoff run: During the takeoff run, to stay within the allowable path deviation of 4.6.5.1, yaw-control forces shall not exceed _____ lb.

Airborne: For the continued takeoff, to achieve straight flight following sudden asymmetric loss of thrust and then maintain straight flight throughout the climb-out, as in 4.6.5.1, shall not require a yaw control pedal force greater than _____ lb.

REQUIREMENT RATIONALE (4.6.7.8)

Safe operation in the event of a propulsive failure is a critical consideration for multi-engine aircraft. Yaw control force is one important aspect.

REQUIREMENT GUIDANCE

The related MIL-F-8785C requirements are paragraphs 3.3.9.1 and 3.3.9.2.

Recommended values:

Maximum yaw pedal forces: 180 lb for both takeoff run and airborne

This requirement is a companion to 4.6.5.1. The object is to insure that, following loss of thrust during the takeoff run, the pilot can either safely abort or safely continue the takeoff and climbout without losing directional control.

Again, 120 lb may be a more satisfactory, safer upper limit considering the capabilities of the entire pilot population. Pending further data, that limit (as in FAR Part 23 for prolonged operation) might be used here.

REQUIREMENT LESSONS LEARNED

5.6.7.8 Yaw axis control force limits for asymmetric thrust during takeoff-verification.

Verification shall be by analysis, simulation and flight test.

VERIFICATION RATIONALE (5.6.7.8)

Verification should be accomplished during demonstration of compliance with 4.6.5.1.

VERIFICATION GUIDANCE

See 5.6.5.1 guidance. With the aircraft configured at its lightest weight, simulated engine failures during takeoff must be performed in the conditions specified. Simulation is not recommended for ultimate verification of compliance with the ground roll portion of this requirement because of the known problems with developing an accurate landing gear model.

VERIFICATION LESSONS LEARNED

MIL-STD-1797A
APPENDIX A

4.6.7.9 Yaw axis control force limits with flight control failures.

The change in yaw control force required to maintain constant attitude following a failure in the flight control system shall not exceed _____ lb for at least 5 seconds following the failure.

REQUIREMENT RATIONALE (4.6.7.9)

Limits must be placed on the maximum force to counter the yaw trim change after a failure of any portion of the primary flight control system.

REQUIREMENT GUIDANCE

The related MIL-F-8785C requirement is paragraph 3.5.5.2.

Recommended value:

Maximum yaw control force: 50 lb

It seems reasonable to state a time limit during which this requirement applies. Zero to two seconds generally should be a rational range of times for the pilot to react (whether he is set for the failure or taken unawares), and it should be possible to retrim after 5 seconds.

REQUIREMENT LESSONS LEARNED

5.6.7.9 Yaw axis control force limits with flight control failures-verification.

Verification shall be by analysis, simulation and flight test.

VERIFICATION RATIONALE (5.6.7.9)

Where safety considerations preclude flight testing for verification, simulation is a suitable alternative. See the 5.6.5.2 discussion.

VERIFICATION GUIDANCE

All failures investigated in accordance with section 4.1.7 need to be examined, at the most critical flight conditions.

VERIFICATION LESSONS LEARNED

MIL-STD-1797A
APPENDIX A

4.6.7.10 Yaw axis control force limits -- control mode change.

The change in yaw control force required to maintain zero sideslip following configuration changes or engagement or disengagement of any portion of the primary flight control system due to pilot action in stabilized flight shall not exceed the following limits: _____. These requirements apply only for Aircraft Normal States.

REQUIREMENT RATIONALE (4.6.7.10)

Any unnecessary distractions and added workload can interfere with a pilot's mission performance.

REQUIREMENT GUIDANCE

The related MIL-F-8785C requirement is paragraph 3.5.6.2.

It is recommended that for at least 5 seconds following the mode change, the change in yaw control force shall not exceed 10 lb above the basic controller breakout force.

For minimal disruption, the transfer to an alternate control mode should occur with a negligible transient. The recommended value is a reduction from the 50 lb used in MIL-F-8785C, which seems unreasonably large. While there are no hard data upon which to base this number, it is given as a recommended value only to show that a significant transient when transferring control modes is not acceptable.

This requirement has been of minimal importance in the past; however, with development of direct force control augmentation (for example, 4.6.1.3), the impact of this requirement will increase.

REQUIREMENT LESSONS LEARNED

5.6.7.10 Yaw axis control force limits -- control mode change-verification.

Verification shall be by analysis, simulation and flight test.

VERIFICATION RATIONALE (5.6.7.10)

This is needed to verify the control mode change.

VERIFICATION GUIDANCE

Demonstration will involve mode switching at representative altitudes throughout the Operational Flight Envelope, focusing on those areas of airspeed, altitude, and task that would produce the largest transients between the two modes involved.

VERIFICATION LESSONS LEARNED

MIL-STD-1797A
APPENDIX A

4.6.7.11 Yaw axis breakout forces.

Yaw-control breakout forces, including friction, preload, etc., shall be within the following limits: _____ . These values refer to the cockpit control force required to start movement of the surface.

REQUIREMENT RATIONALE (4.6.7.11)

The cockpit control should not respond to very small inadvertent pilot commands, yet proportional controls must transmit pilot commands precisely.

REQUIREMENT GUIDANCE

The related MIL-F-8785C requirement is paragraph 3.5.2.1.

Recommended Level 1 and 2 values for yaw-control pedals are:

CLASS	MINIMUM	MAXIMUM
I, II-C, IV	1 lb	7 lb
II-L, III	1 lb	14 lbs

For Level 3 these values may be doubled.

These limits have been derived from long experience, although comprehensive documentation is lacking. Pilots have objected to higher breakout forces on some aircraft.

REQUIREMENT LESSONS LEARNED

5.6.7.11 Yaw axis breakout forces-verification.

Verification shall be by test.

VERIFICATION RATIONALE (5.6.7.11)

In most cases, measurement of breakout forces on the ground will suffice.

VERIFICATION GUIDANCE

It is possible that vibration, temperature, pressurization, etc. effects may influence the results. If there is any question, flight measurement in the critical environment will be definitive.

VERIFICATION LESSONS LEARNED

MIL-STD-1797A
APPENDIX A

4.7 Flying qualities requirements for the lateral flight path axis

4.7.1 Dynamic response for lateral translation.

The following requirements shall be met:

- a. Dynamic response to direct force control input: The bandwidth of the open-loop response of lateral position to lateral translation control input shall be greater than _____ for Flight Phase _____. Lateral translations shall occur at essentially zero bank angle and zero change in heading
- b. Steady-state response to lateral translation control input: Maximum control force input shall produce at least _____ degrees of sideslip
- c. Lateral translation control forces and deflections: Use of the primary lateral translation control shall not require use of another control manipulator to meet requirement a. The controller characteristics shall meet the following requirements: _____
- d. Crew accelerations: Abrupt, large control inputs shall not produce pilot head or arm motions which interfere with task performance. Crew restraints shall not obstruct the crew's normal field of view nor interfere with manipulation of any cockpit control required for task performance.

REQUIREMENT RATIONALE (4.7.1)

This requirement specifies the useful range of response characteristics of aircraft that utilize direct force control (DFC) in the lateral translation mode, which changes aircraft lateral velocity at zero bank angle and constant heading. A sketch of the airplane motions, with a summary of useful features of this mode, is given below (taken from AIAA Paper 77-1119).

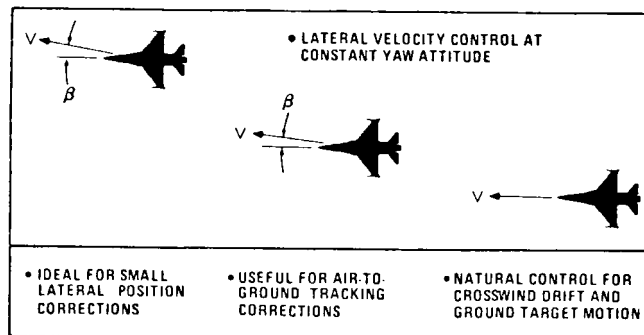

REQUIREMENT GUIDANCE

The related MIL-F-8785C requirement is paragraph 3 4.11.

Recommended values (Part a): There are no data of sufficient quality upon which to set a lower limit on lateral position bandwidth. Until the required data become available, the following qualitative requirement should be applied: Lateral translation response to control inputs shall be acceptable to the crew in performing the mission tasks.

Recommended values (Part b) It is recommended that it should be possible to generate at least 4 deg of sideslip at the flight conditions where lateral translation is to be utilized. Analysis and simulation of task performance may yield a better-suited value.

MIL-STD-1797A
APPENDIX A

Recommended values (Part c): If conventional cockpit controls are to be used as the DFC controller, the requirements for these controls provide some guidance, i.e., 4.6.7 for rudder pedals and 4.5.9 for stick.

Part d requirements are for the pilot's restraints. From the references cited, 0.5g is about the maximum tolerable lateral acceleration without special restraints.

The rationale for using a bandwidth criterion for DFC modes is given in the discussion of 4.6.1.3. Procedures to be followed in applying the bandwidth criterion are given there.

SUPPORTING DATA

The only supporting data available are the F-16 CCV (AIAA Paper 77-1119) and two configurations flight tested in AFWAL-TR-81-3027. The AFWAL-TR-81-3027 data are shown below in table L. Unfortunately, the control sensitivities were not optimized, which tended to obscure the results. Hence it was not possible to define specific limits on bandwidth for the lateral translation mode. However, the results are presented here to provide some insight.

TABLE L. Summary of Cooper-Harper pilot ratings for lateral translation mode.

CONFIGURATION	BANDWIDTH (rad/sec)	FORMATION				AIR TO AIR			
		MP	WN	RH	KO	MP	WN	RH	KO
LT1	1.5	2.5	2.5		3	6	4	5	4
LT1Y	4.0	5			3.5		5	2.5	2.5

Configuration LT1Y was developed to test the bandwidth hypothesis by increasing the inherent bandwidth of Configuration LT1 via favorable yaw coupling. Unfortunately, the control sensitivities were not systematically varied for the LT1Y configuration. A review of the pilot comments indicated that the primary deficiency of the LT1Y mode was the jerky or abrupt nature of heading changes to CCV control inputs. Such comments are typical for aircraft with excessive control sensitivity, and the evaluation of Configuration LT1Y cannot be confidently ascribed to its dynamics or compared directly with Configuration LT1. The scatter in pilot ratings for LT1Y in table L is probably a measure of the degree to which each pilot objected to excessive control sensitivity.

The F-16 CCV lateral translation mode was simply a decoupling of axes so that pure translation resulted from DFC inputs. From AFWAL-TR-81-3027 (page 13) the lateral velocity response for a perfectly decoupled aircraft is

$$\frac{\dot{y}}{\delta_{DFC}} = \frac{Y_{\delta_{SF}}}{s - Y_v}$$

It follows that the basic response of the lateral translation mode is limited by the inverse time constant Y_v , which tends to be a small number, on the order of 0.2 to 0.3 for contemporary aircraft (0.25 for the F-16 at the test condition). Physically this means that even with perfect decoupling the lateral translation mode could require a special piloting technique due to a tendency for the aircraft to continue drifting laterally for a time upon release of the CCV control. An example of this is quoted below from AIAA Paper 77-1119 (CCV Flight No. 38-F16):

A technique not previously evaluated using lateral translation involves reversing the Aft command before the original side velocity had coasted to a stop, thereby providing

MIL-STD-1797A
APPENDIX A

increased deceleration to expedite the stop. This method of operation substantially improved the usefulness of the ... mode. In previous evaluations of this mode the side velocity was allowed to coast to a stop after the applied command was removed.

The above pilot commentary indicates that the basic DFC response was unacceptably slow (low Y_v), but that a special piloting technique could be utilized to make the mode acceptable, that is, effectively generating lead to augment Y_v . It follows logically that a better lateral translation mode could be developed by augmenting Y_v via feedback of sideslip to the direct side force controller. This has implications on the frequency response characteristics of the servo drive as well as the authority required for the direct side force control.

A Y_v of 0.25 results in a lateral position bandwidth of about 0.3. The above commentary indicates that this value of bandwidth corresponds more to Level 2 than to Level 1 flying qualities. Hence, the minimum acceptable bandwidth (for the formation flying task) lies somewhere between 0.3 rad/sec and 1.5 rad/sec (see table L).

REQUIREMENT LESSONS LEARNED

The above noted F-16 CCV experience indicates that, in addition to decoupling, the lateral translation mode requires a β or \dot{y} feedback to augment Y_v and thereby obtain the crisp response required to make this mode useful.

5.7 Flying qualities requirements for the lateral flight path axis-verification

5.7.1 Dynamic response for lateral translation-verification.

Verification shall be by analysis, simulation and flight test.

VERIFICATION RATIONALE (5.7.1)

Because of the scarcity of data upon which to base a limiting value of bandwidth for this mode, there are no firm values recommended. Until better data are obtained, the final demonstration of compliance with this requirement should be by evaluation in operational tasks during flight test. In fact, the data generated during such tests should be utilized to upgrade the requirements.

VERIFICATION GUIDANCE

The critical conditions will depend upon the operational use which is to be made of the control mode. For a given sideslip angle, lateral acceleration increases with airspeed.

VERIFICATION LESSONS LEARNED

4.8 Flying qualities requirements for combined axes

A qualitative requirement on control cross-coupling in general is 4.1.11.8. The requirements of 4.8 treat more specific topics.

4.8.1 Cross-axis coupling in roll maneuvers.

In yaw-control-free maximum-performance rolls through _____ degrees, entered from straight flight or during turns, pushovers, or pullups ranging from 0 g to 0.8 n_L, including simultaneous pitch and roll commands, none of the resulting yaw or pitch motions, or sideslip or angle of attack changes, shall exceed structural limits or cause other dangerous flight conditions such as uncontrollable motions or roll autorotation. Rudder pedal inputs used to roll the aircraft with lateral control fixed, or when used in a coordinated manner with lateral control inputs, shall not result in departures in pitch, roll, or yaw.

During combat-type maneuvers involving rolls through angles up to _____ degrees and rolls which are checked at any given bank angle up to that value, the yawing and pitching shall not be so severe as to impair the tactical effectiveness of the maneuver. These requirements define Level 1 and 2 operation.

REQUIREMENT RATIONALE (4.8.1)

Both aerodynamic and inertial cross-coupling of pitch and yaw motions with rolling are common for modern aircraft. The ensuing motions can be violent in nature, leading to prolonged loss of control.

REQUIREMENT GUIDANCE

The related MIL-F-8785C requirement is paragraph 3.4.3.

Recommended values for both blanks:

AIRCRAFT CLASS	RECOMMENDED ROLL ANGLE (DEG)
I and IV	360
II and III	120

but not to exceed the structural roll angle limit applicable to the normal load factor.

The roll angle restrictions mentioned in this requirement are the structural design limits, as for example in MIL-F-8861.

The dynamics of the pitch and yaw coupling associated with rapid rolls are complex and nonlinear. In general, the dynamics involve interactions among the aircraft inertia properties, its aerodynamic properties, and the kinematics of the rolling motion; coupling is more severe the more the mass is concentrated along the fuselage. The cross-axis coupling phenomena related to flight near or beyond stall are treated in 4.8.4.

It should be noted that inertial pitch/roll coupling may set the pitch control power requirements on the aircraft. This is especially true for Class IV aircraft, on which very high roll rates are common, or where reduced static stability is employed in the longitudinal axis, as with the F-16.

The so-called stability-axis yaw damper (in which body-centerline-axis r - pot is fed back to the rudder) reduces the adverse sideslip in high-angle-of-attack maneuvering, thus minimizing aerodynamic coupling; but thereby it increases roll rate and with it the pr and p² inertial coupling terms in the pitch axis, viz:

$$\dot{q} = \frac{I_z - I_x}{I_y} pr + \frac{I_{xz}}{I_y} (r^2 - p^2) + \frac{1}{I_y} M_{aero}$$

MIL-STD-1797A
APPENDIX A

Use of such augmentation requires a compromise between allowable sideslip and inertial coupling. Moreover, I_{xz} is generally significant in stability (flight-path-oriented in the steady state) axes but zero (by definition) in principal axes. Thus rolling about the flight path rather than the principal x axis influences another term to aggravate pitch coupling. Nevertheless, stability-axis rolling has been found helpful. So have increased directional stability and yaw damping. Analysis and simulation should indicate the best combination of stability augmentation.

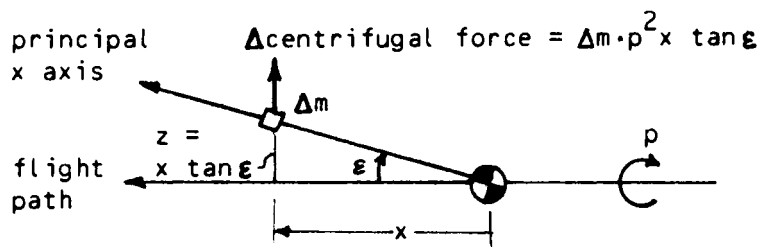

From the sketch, the inertial pitching moment of the mass element is

$$\Delta M = -(p^2 z \cdot \Delta m) \cdot x = -p^2 \cdot xz \Delta m$$

Integrating over the principal x axis, $M = -I_{xz} p^2$.

REQUIREMENT LESSONS LEARNED

It has sometimes been difficult to meet both this requirement and the roll performance requirement, to the extent that a fix for inertial coupling adopted during the flight-test phase was to severely limit the roll control power. This, of course, has a detrimental effect on a fighter's air combat capability. Thus, early design attention is in order.

This requirement should be coordinated with the structural specifications. In one instance, flying qualities predictions indicated good roll performance in 360-degree rolls at high load factor. However, the structures group did not know of this requirement and only designed the structure for 1-g, 360-degree rolls. It was pointed out that 360-degree rolls at high g were required for various combat maneuvers.

During prototype evaluation of the YF-16 Lightweight Fighter, coupled loss of control was encountered on two separate occasions. According to AFFTC-TR-75-15, "Lateral performance at low dynamic pressure was sufficiently high that roll and yaw rates could be generated which produced a nose-up pitching moment that could not be controlled by full trailing-edge-down elevator."

AFFTC-TR-75-15 concludes:

The most significant conclusion and recommendation concerning the handling qualities of the YF-16 deal with coupling: A potential for loss of control due to inertial pitch/roll coupling was predicted after the completion of stabilator saturation tests conducted during the High Angle of Attack test phase. The potential was later inadvertently, demonstrated during the air combat maneuvering evaluation. The single spin of the flight test program was also coupling-related. Considering the production potential of the design, it is significant that. (1) two coupled departures were experienced during the prototype program, and (2) both occurred during controlled evaluations flown by highly qualified and experienced pilots. The deficiency represents a serious hazard to the safe operational use of the aircraft. The YF-16's potential for inertial pitch/roll-coupled departures should be eliminated even though its occurrence is associated with the outer

MIL-STD-1797A
APPENDIX A

portions of the useful flight envelope. The flexibility afforded by the electronic flight control system should be fully explored as an alternative to more complicated and costly means of correcting the deficiency. A reduction in the roll rate available to the pilot at high angles of attack should be considered. External aerodynamic configuration changes should be made to eliminate the potential for inertial pitch/roll coupling only if the deficiency cannot be corrected by modification of the flight control computer.

This last AFFTC recommendation must be taken as a concession, after the fact, to expediency. While the control laws can be changed more easily than the aerodynamic configuration, their effectiveness here is severely limited by available control authority and rate (see 4.1.11.5 REQUIREMENT GUIDANCE). Also, increasing control law complexity generally creates additional time lag which may cause piloting problems.

5.8 Flying qualities requirements for combined axes-verification

5.8.1 Cross-axis coupling in roll maneuvers-verification.

Verification shall be by analysis, simulation and flight test.

VERIFICATION RATIONALE (5.8.1)

The nonlinear, violent manner of cross-axis coupling makes flight testing almost mandatory. However, ground simulation can give some insight into potential problem areas in the flight regime. It may be necessary to perform maneuvers with control combinations other than those specified to determine coupling problems. If the roll controller alone does not meet the control power requirements of 4.5.8.1 at high angle of attack, pilots may use supplemental rudder pedal deflection during air combat with Class IV aircraft; if pertinent, that pedal usage should be evaluated. Also, as already noted, nose-down pitching may increase susceptibility to roll inertial coupling.

VERIFICATION GUIDANCE

At least a 5-degree-of-freedom nonlinear analysis (constant speed is generally a good assumption) is needed to portray the motions or their characteristics. A range of control deflections should be examined. Aircraft-nose-down pitch control is commonly critical (see, for example, Dynamics of Atmospheric Flight). However, with the additional assumptions of a constant roll rate about the principal axis and negligible gravity, an approximation to the critical roll rate can be found more easily as a first cut. Near and beyond the critical roll rate, large pitch or yaw excursions (or acceleration to an extremely high roll rate) can be expected. A quadratic expression approximating the critical roll rate squared, p_{cr}^2 , is

$$\left(\omega_{sp}^2 - \frac{b(k_z^2 - k_x^2)}{\bar{c}^2 k_y^2} p_{cr}^2 \right) \left(\omega_d^2 - \frac{k_y^2 \bar{c}^2 / b^2 - k_x^2}{k_z^2} p_{cr}^2 \right) + \frac{g\rho V}{4(W/S)k_y^2 k_z^2} \left[C_{m_q} + 2 \frac{b^2}{\bar{c}^2} (k_z^2 - k_x^2) C_{y_\beta} \right] \left[C_{n_r} - 2(k_y^2 \bar{c}^2 / b^2 - k_x^2) (C_{L_\alpha} + C_D) \right] p_{cr}^2 = 0$$

MIL-STD-1797A
APPENDIX A

in terms of the uncoupled approximations for ω_{sp}^2 and ω_d^2 :

$$\omega_{sp}^2 \approx \frac{-g}{C_{L_1} k_y^2 \bar{c}} \left[\frac{C_{m_\alpha}}{C_{L_\alpha} + C_D} + \frac{g \rho \bar{c}}{4(W/S)} C_{m_q} \right]$$

$$\omega_d^2 \approx \frac{g}{C_{L_1} k_z^2 b} \left[C_{n_\beta} + \frac{g \rho b}{4(W/S)} C_{y_\beta} C_{n_r} \right]$$

VERIFICATION LESSONS LEARNED

For flight testing, a careful buildup with prior analysis and simulation is indicated, for the sake of safety.

MIL-STD-1797A
APPENDIX A

4.8.2 Crosstalk between pitch and roll controllers.

The pitch- and roll-control force and displacement sensitivities and breakout forces shall be compatible so that intentional inputs to one control axis will not cause objectionable inputs to the other.

REQUIREMENT RATIONALE (4.8.2)

Force and displacement requirements for pitch and roll controllers are separately specified elsewhere, but their operation in combination through the same stick or column can cause problems if these characteristics are incompatible.

REQUIREMENT GUIDANCE

The related MIL-F-8785C requirement is paragraph 3.4.4.

For design guidance, 5 percent cross-coupling has been suggested by one source as “normal and not objectionable.” In the absence of data, though, we are reluctant to propose any specific hard limit.

Control harmony has several aspects. One problem is that the pitch and roll control forces must be in the proper ratio for gross unsymmetrical maneuvers, to enhance proper coordination of the maneuver. Another problem is that unless the pitch and roll control sensitivities and breakout forces are properly matched, intentional inputs to one control can result in inadvertent inputs to the other. For example, many heavy airplanes with unboosted controls have had aileron forces that were much too high with respect to the elevator forces. As a result, it was difficult to control pitch attitude accurately when rolling rapidly into a turn. In addition, for Class IV highly maneuverable aircraft it is often difficult to pull the centerstick straight back due to arm and manipulator geometry and the lack of appropriate arm support. If lateral forces are low compared to longitudinal forces, some inadvertent lateral input is inevitable. The intent of this requirement is to prevent troublesome situations of that sort.

REQUIREMENT LESSONS LEARNED

This requirement may be of increasing significance with continued development of sidestick controllers. The force stick of the YF-16 was especially susceptible to longitudinal/lateral interactions (crosstalk), as described in AFFTC-TR-75-15:

... lateral versus longitudinal stick force crossplots and other quantitative data indicated that the YF-16's prototype force controller was susceptible to crosstalk during both classical evaluation and mission-oriented tasks. The pilots did not identify crosstalk as operationally significant, possibly because they subconsciously reacted to aircraft motion and modified their force inputs accordingly. Further development of the force controller should reflect that the stick's rotational orientation may not be optimum when aligned parallel with the longitudinal and lateral axes of the aircraft. Preliminary quantitative data analysis suggests that the stick should be rotated clockwise (as seen from above) up to approximately fifteen degrees.

Later operational experience with the F-16 indicates that crosstalk is indeed a noticeable problem. For example, left banks are commonly observed during the pitch rotation for takeoff and landing. The F-16's newer, movable sidestick axis is rotated 12 deg clockwise, essentially eliminating crosstalk in takeoff and landing.

5.8.2 Crosstalk between pitch and roll controllers-verification.

Verification shall be by analysis, simulation and flight test.

MIL-STD-1797A
APPENDIX A

VERIFICATION RATIONALE (5.8.2)

Compliance with this requirement will be shown through the course of normal simulation or flight testing; pilot comments and crossplots as mentioned above should reveal any potential deficiencies.

VERIFICATION GUIDANCE

It is thought that no special guidance is needed.

VERIFICATION LESSONS LEARNED

MIL-STD-1797A
APPENDIX A

4.8.3 Control harmony.

The following control forces are considered to be limiting values compatible with Ask the pilot's capability to apply simultaneous forces: _____. Larger simultaneous control forces shall not be required to perform any customary and expected maneuvers.

REQUIREMENT RATIONALE (4.8.3)

Normal maneuvering involving two or three controllers can be taxing, and precise maneuvering difficult, if any one controller requires large force inputs, even if each of the forces meets its single-axis requirement.

REQUIREMENT GUIDANCE

The related MIL-F-8785C requirement is paragraph 3.4.4.1.

Recommended limits:

CONTROL TYPE	PITCH	ROLL	YAW
Sidestick	20 lb	15 lb	
Centerstick	50 lb	25 lb	
Wheel			
(two-handed tasks)	75 lb	40 lb	
(one-handed tasks)	50 lb	25 lb	
Pedal			175 lb

The cockpit control forces required to perform maneuvers which are normal for the aircraft should have magnitudes which are related to the pilot's capability to produce such forces in combination. The pilot cannot apply forces simultaneously to all three controls that are as large as those forces that can be applied to one control at a time.

The 40 pounds allowed for wheel forces is a carryover from MIL-F-8785C. It is based on the use of two hands, a rare occurrence in most flying tasks since one hand is on the throttle (s) during maneuvering. The sidestick forces are based upon both the maximum forces on the F-16 movable stick (AFFTC-TR-79-40) and results of the USAF Test Pilot School evaluations (AFFDL-TR-79-3126). The forces chosen are 75-90 percent of the maximum forces used.

Another very important aspect of control harmony, the relative timing of pilot forces and deflections of the several controls used to perform an operational maneuver, is hard to quantify. There are also the force and deflection relationships, such as in turn entry, steady turns and reversals. These aspects of control harmony are subjective in nature.

REQUIREMENT LESSONS LEARNED

See 4.2.9.2 Lessons Learned.

5.8.3 Control harmony-verification.

Verification shall be by analysis, simulation and flight test.

VERIFICATION RATIONALE (5.8.3)

In performing such maneuvers as dives, steady turns, and stalls, maximum forces should not exceed the combined forces specified herein, and the test pilots should evaluate the control harmony.

MIL-STD-1797A
APPENDIX A

VERIFICATION GUIDANCE

The key to applying this requirement is in definition of normal maneuvers. Such maneuvers should be all maneuvers required by the missions defined for the aircraft, including training.

VERIFICATION LESSONS LEARNED

MIL-STD-1797A
APPENDIX A

4.8.4 Flight at high angle of attack.

4.8.4 through 4.8.4.3.2 concern stall warning, stalls, departures from controlled flight, post-stall gyrations, spins, recoveries, and related characteristics. They apply at speeds and angles of attack which in general are outside the Service Flight Envelope. They are intended to assure safety and the absence of mission limitations due to high-angle-of-attack flight characteristics.

REQUIREMENT RATIONALE (4.8.4)

Requirements on approach to stall, stalls, departures, and subsequent motions apply for high-angle-of-attack flight. The paragraph defines the purpose of the high-at requirements. (Avoidance of a locked-in deep stall is considered to be covered adequately in 4.1.11.5.)

REQUIREMENT GUIDANCE

The related MIL-F-8785C requirement is paragraph 3.4.2.

Changes from MIL-F-8785C are the result of reawakened interest, occasioned by numerous aircraft losses. A large number of aircraft incidents have been attributed to loss of control at high angle of attack and it was conjectured that many losses in Vietnam combat with no evidence to determine a cause might well have been due to loss of control at high angle of attack. Whereas previous requirements had concentrated on demonstration of acceptable stall and spin characteristics, the new requirements emphasized prevention of loss of control (departure) as well. All aircraft are covered with flight demonstration maneuvers and control abuse appropriate to the Class and mission. Amendment 2 changed many of Amendment 1's quantitative requirements related to test and evaluation techniques to qualitative statements, and MIL-F-8785C made no further changes in high- α requirements. The requirements in this regime of nonlinearities remain largely qualitative.

The stall and spin requirements that follow are related by their application at high angles of attack, outside the Service Flight Envelope. Therefore, this requirement is retained to serve as an overview of characteristics and problems with high-AOA flight. The discussions presented in Lessons Learned summarize recent insights and information on high- α flight, applicable in general to any of the stall/spin requirements.

Based upon the requirements of this paragraph, high angle of attack is considered to be at and above the α for stall warning (4.8.4.2.1), generally outside the Service Flight Envelope in which the bulk of the other flying qualities requirements apply. Thus the α value which is considered high will vary with the situation, aircraft, configuration, and Mach number.

Note that the requirements apply as well to asymmetric loadings called out in the contract or experienced in normal operation.

Future advanced fighter aircraft may have the capability to fly/maneuver in the post-stall region. This capability will exist through the use of improved high-or aerodynamics, digital flight control systems and thrust vector control. Manned simulation studies indicate tactical utility and increased combat effectiveness available via high- α maneuvering. Consequently, continued flying qualities research is needed to establish stability and control requirements for flight operations in this region. Suggested areas to address are:

- Definition of the post-stall region

- Control power requirements to provide deep stall recovery capability

- Control power requirements to prevent departures from controlled flight

- Engine operating requirements and means to fulfill them

MIL-STD-1797A
APPENDIX A

Post-stall warning and pilot cues

Multiaxis, nonlinear dynamics at high α , with good representation of the aerodynamics

Roll, pitch and yaw rate capability (where rolling about the flight path is mostly body-axis yawing): agility

Deceleration/acceleration capability (Nobody wants to stay long in a state of very low energy).

Maximum allowable/usable sideslip and yaw rate at high angle of attack

Design criteria for departure resistance

Aerodynamic means to improve departure/post-stall characteristics, compatible with high performance, low observables, ...

Thrust vectoring control power requirements for high- α stabilization and control

Cockpit display and visibility requirements at high angle of attack.

These needs are listed to indicate the considerations necessary if an aircraft is to be designed for effective post-stall flight. Data are lacking for more quantitative recommendations.

REQUIREMENT LESSONS LEARNED

A recent survey of 33 aircraft manufacturers, research and test agencies, and operational commands and squadrons (AFWAL-TR-81-3108) provides considerable information on "mission phases or tasks involving high-AOA flight, past or present flying quality problems, stall/departure/spin encounter, future desires, etc." While information was sought on all Classes of aircraft, most of the concern dealt with departure/spin resistance for Class IV, highly maneuverable aircraft. It is realized, however, that this is very important for all Classes. Mission requirements such as initial pilot training, forward air control, increased gross weight or high-altitude start of long-range cruise (to name just a few) expose Class I, II and III aircraft to any departure tendency. Concern of operational pilots covered "inadequate cues, flight control system limiters which obviously remove the pilot from control, and adequate control power."

A major consensus derived from the AFWAL-TR-81-3108 survey is that, for Class IV aircraft,

... high-AOA maneuvering in combat, although spectacular or glamorous, is not a primary tactic. It is definitely a subordinate area but one which should not limit the use of the aircraft. High AOA is equated with high energy loss, slowing velocity, and becoming an easy target for the opponent's gun or missile. It is much more desirable to maintain high specific energy by avoiding hard maneuvering. High-AOA combat generally results from pitting aircraft of similar performance and maneuvering capabilities against one another. If the opponents have dissimilar performance capabilities, the fight generally will not last long enough to degenerate to high AOA. Thus most high-AOA flight results from air combat maneuver (ACM) training against the same type of aircraft. It generally involves gun fighting, and new weapon systems coming into the inventory are counted on to reduce gun fighting.

Thus, considering that high- α maneuvering is subordinate to the primary mission but should not limit the aircraft usefulness, the major expressed concern involved departure/spin resistance, flight cues, and the role of the flight control system.

(More recently still, we have seen a renewed interest in extreme angles of attack for air combat maneuvering. This need is one matter that must be settled at the outset of a design, since it can have a great impact on the configuration.)

MIL-STD-1797A
APPENDIX A

Typically Class I aircraft have much lighter wing loadings than the rest; and most are designed to meet FAA regulations (FAR Part 23), then adapted for military operations; so high- α flight is looked at differently for their usage. Similarly, due to the very large inertias and limited maneuvering of Class III aircraft in all axes, high- α departures or large uncommanded motions are not structural design considerations, so vehicle design should assure that such maneuvers are not likely to be encountered. The major concern for departures and spins (4.8.4.3) is therefore Class IV aircraft.

Table LI (from AFWAL-TR-81-3108) summarizes pilot opinions on the high- α characteristics of several modern Class IV airplanes. In terms of design philosophy AFWAL-TR-81-3108 concludes that there are three separate schools of thought: aerodynamic dominance (e.g., the F-5), balanced aerodynamics and flight control system (F-15), and flight control system dominance (F-16). The military using agencies "expressed views advocating specification- and design-restraint..High- α flying quality specification requirements should not dictate aircraft configuration, flight control system complexity, or even overly compromise primary mission performance." Despite this desire, recent designs (F-15, F-16, F-18, F-20 for example) owe some of their prominent external configuration features, considerable control system logic, or both, to high- α considerations. These features were deemed necessary just to avoid excessive occurrences of loss of control.

The high- α requirements are essentially unchanged from MIL-F-8785C.

The reader is referred to AFWAL-TR-81-3108's excellent summary for additional references and more detail on high-angle-of-attack requirements, characteristics and criteria.

5.8.4 Flight at high angle of attack-verification.

Verification shall be by analysis, simulation and flight test.

VERIFICATION RATIONALE (5.8-4)

A high- α flight test program (a) is necessary to bring out under controlled conditions any idiosyncrasies of the aircraft that might be encountered later, in service use, and (b) needs careful preparation, including prior analysis and model testing, provision of emergency recovery means, propulsion system modification such as continuous ignition, backup hydraulic power, etc.

VERIFICATION GUIDANCE

A full range of internal loadings, and the external loadings specified in the contract, should be tested. If modifications such as a spin chute or a flight-test nose boom might change the aircraft characteristics, some testing may have to be repeated in the service configuration. AFFDL-TR-65-218, among others, indicates ranges of some of the critical inertial parameters that generally give certain spin and recovery characteristics. MIL-S-83691 (for the Air Force) and MIL-D-8708 (for the Navy) give further guidance.

MIL-STD-1797A
APPENDIX A

TABLE LI. Digest of pilot comments on specific aircraft high-AOA flying characteristics (from AFWAL-TR-81-3108).

AIRCRAFT	OVERALL HIGH-AOA F.Q.	DEPARTURE CHARACTERISTICS	CUES	OTHER
A-7	Departure hazard inappropriate to ground attack mission	Strong adverse yaw Severe nose slice Predictable, repeatable Easily recovered	Buffet	PCAS* turned off at high α Wing stores increase stability
A-10	High-AOA – usually defensive No adverse flying characteristics No worry about departure or spin High pitch rate capability – can pull through stall warning too fast	Very resistant to departure Very mild stall – little warning Mild buffet Some wing rock Mild yaw	α : Aural tone Peak performance steady Stall-beep V: Noise level Stick position	Ailerons remain effective in stall – like cannon
F-4C/D/E	Acceptable to good for fighter Departure hazard for ground attack Good control effectiveness Must change control technique to rudder maneuvering	Strong adverse yaw Abrupt nose-slice/roll Predictable, repeatable Recoverable (if sufficient altitude)	α : Buffet (poor, early, heavy) V: Stick force Dig-in	Force harmony problems at low dynamic pressure Can over-rotate or over-g Roll SAS turned off
F-4E (Leading edge slat)	Excellent Better separation between $C_{L_{max}}$ and departure α Less roll rate capability Use aileron and rudder to roll	Reduced adverse yaw Departure resistant Roll departure Somewhat unpredictable at very high α Recovers quickly	α : Buffet (good, steady, increase) Aural tone Stick position V: Buffet increase Stick force Opt. Turn: Aircraft buzz	Roll SAS turned off
F-5E	Excellent Can point aircraft at very low speeds Never worry about α Lose aileron roll power – must use rudder maneuvering	Departure resistant Rudder-induced high yaw rate Difficult to recover	α : Buffet Stick position V: Flap horn Opt. Turn: Buffet	No roll rate CAS Full aft stick – max α Centerline stores degrade stability significantly

*PCAS = roll rate command augmentation system

MIL-STD-1797A
APPENDIX A

**TABLE LI. Digest of pilot comments on specific aircraft high-AOA flying characteristics
(from AFWAL-TR-81-3108). - Continued**

AIRCRAFT	OVERALL HIGH-AOA F.Q.	DEPARTURE CHARACTERISTICS	CUES	OTHER
F-14A	Good – “Honest” High control power Requires rudder maneuvering	Adverse aileron yaw Departure resistant Yaw/roll departure Severity is speed dependent	Generally poor Buffet Stick position Stick force	Main problem with asymmetric thrust PCAS* turned off at high α
F-15A	Excellent High longitudinal control power Some worry about over-g SRI† makes airplane consistent and repeatable Can override SRI	Departure resistant Nose slice Recovers hands off Autoroll if inverted	α : Mild wing rock Decreasing roll power Nose drop at stall Opt. Turn: Light buffet	Constant F_g/n longitudinal CAS PCAS turned off at high α SRI provides all stick maneuvers $p\alpha \rightarrow \delta_r$ causes inverted autoroll
F-16A	Excellent maneuvering Maneuver with abandon: No worry about g or departure Tendency to excessive use of high α because of poor cues Limiters “take over control”, save poorly skilled pilot, restrict highly skilled pilot	Departure preventing system Can be tricked into: Lat/Dir departure G-overshoot Super stall Automatic anti-spin system Recovery sometimes difficult	None No stick cues No buffet No artificial cues	Constant F_g/n CAS SRI provides all stick maneuvering Maneuver limits n, α, p Need limit changes with stores
F-111/FB-111	No warning of impending stall departure Flying qualities excellent right up to departure Suddenly fall off cliff	Insidious Departure susceptible Nose slice/roll Unpredictable Non-recoverable at low altitude	No natural cues (stick force, buffet) Artificial Shaker Horn Lights	FCS provides uniform and cueless flying qualities Autotrim can produce inadvertent stall High α encounter often related to change in thrust

*PCAS = roll rate command augmentation system

†SRI = stick-rudder interconnect

MIL-STD-1797A
APPENDIX A

A critical design review of the departure and spin characteristic should be performed using pilots who represent the contractor and the procuring agency in a manned simulation program. Prior to CDR, the contractor should submit an evaluation plan, to be approved by the procuring activity, that:

- a. Indicates the range of aircraft gross weights/center-of-gravity positions, and aircraft normal and failure states associated with each flight phase.
- b. Specifies maneuvers and control inputs to be evaluated for each flight phase. The control inputs evaluated should be broadly classed into four techniques:
 - (1) Ordinary control inputs
 - (2) Misapplied control inputs
 - (3) Consecutive misapplied control inputs
 - (4) Pro-spin control inputs (optional)

It shall be tailored to the Class and structural design criteria of the aircraft. MIL-S-83691 gives guidance Aerodynamic data should be of sufficient quality and quantity to recognize at least the initial characteristics of divergence and spin. The piloted simulation shall address the maneuvers associated with each flight phase, with some extra simulation time allotted to the pilots to allow them to evaluate entry maneuvers not covered by the plan.

Prior to flight-test evaluation of departure and spin characteristics, installation of a recovery system on the flight test aircraft is recommended. In particular the recovery system should be installed such that it does not snag on the control surfaces, regardless of control surface deflection during or after deployment jettison.

A flight test plan similar to the one used for simulation will be submitted before initiation of flight test. Throughout flight test, frequent procuring-activity/contractor coordination meetings should be held to review results to date and determine the safest course to achieve program objectives. The initial flight test evaluation should include a careful buildup to the maneuvers of Technique (1) (ordinary control inputs) in addition to those maneuvers necessary to define stability derivatives and calibration of the air data sensors. After evaluation of Technique (1), a careful buildup test to positive and negative angles of attack and sideslip in excess of planned production limit settings is needed to verify and define stability derivatives. The simulator aerodynamic data, sensor effects, and subsystem effects (e.g., hydraulic/electrical power) should be updated. Continued piloted simulations should be performed to evaluate departure characteristics for Technique (2) control inputs (misapplied control inputs) and for Technique (3) control inputs (the effects of consecutively misapplied control inputs). The effects of Technique (2) control inputs should then be test flown. The results of flight-test and updated simulation results should be utilized for system refinement and pilot handbook information. After completion of the departure phase of the F- 15 program, a spin recovery program was initiated using Technique (4) maneuvers.

VERIFICATION LESSONS LEARNED

On the F-15 and some other aircraft for which vortices off the nose are prime contributors to the high- α characteristics, the flight test nose boom had a marked effect on departure. External stores and store or internal fuel asymmetries have also been found to influence some aircrafts' high- α characteristics significantly.

MIL-STD-1797A
APPENDIX A

4.8.4.1 Warning cues.

Warning or indication of approach to stall or loss of aircraft control shall be clear and unambiguous.

REQUIREMENT RATIONALE (4.8.4.1)

The seriousness of the consequences of stalling, departure or spinning demands clear, unambiguous cues to warn the pilot.

REQUIREMENT GUIDANCE

The related MIL-F-8785C requirement is paragraph 3.4.1.1.

This statement is essentially identical to 4.1.8.1. Its addition here is based upon three observations: 1) the requirement of 4.1.8.1 is intended for any dangerous flight condition, not specifically high-of flight; 2) there may be some instances (e.g., air combat maneuvering at high of) which should not be considered "dangerous"; and 3) warning cues provided on many recent aircraft for high- α flight are considered inadequate (see Lessons Learned).

Providing a consistent, useful warning cue to the pilot continues to be a problem, as shown by a survey of pilots of Class IV airplanes (AFWAL-TR-81-3108). Table LI lists the available high-angle-of-attack cues for various fighter airplanes. AFWAL-TR-81-3108 summarizes:

Lack of adequate high-AOA maneuvering/stall non-visual (e.g., tactile) cues ranked very high on the pilots' problem list. Such cues are a primary source of information when attention is directed away from the instruments -- as is generally the situation surrounding stall encounter. Cues are equally important in air combat to establish maximum and/or optimum maneuver conditions. It appears that very few aircraft have adequate non-visual cues. In particular, single-crew aircraft require a separation of information channels which might be compared with the need for frequency separation in highly augmented aircraft with uncoupled modes of control. That is, artificial devices such as stick or rudder pedal shakers can be (and are) masked by buffet; aural tones can be (and are) masked by radio communications or missile arming and lock-on tones. The preferred cues are buffet itself and possibly the most consistent and desirable tactile cues -- stick force and position. These were stressed over and over by the operational pilots.

The key cues which provide positive indication of changing aircraft AOA or energy state are:

Stick force (per knot or g)

Stick position

Buffet level

Uncommanded aircraft motion

Artificial warning devices

It must be emphasized here that the intent of this requirement, like that of all the high- α requirements, is not to force an artificial limit on the aircraft. The AFWAL-TR-81-3108 survey of using agencies concludes that:

Prevention of dangerous flight conditions via maneuver limiters drew strong objections from a large segment of the military community. Such devices are viewed as double-edged

MIL-STD-1797A
APPENDIX A

swords; they inflexibly protect the aircraft (and crew) from inexperienced or inept piloting at the cost of an (arbitrary) imposed safety margin. In so doing they become a pilot equalizer and make aircraft maneuvering performance predictable to the enemy. Finally, protective limit requirements generally vary with aircraft loading (external or internal) and therefore to be effective entail considerable complexity.

REQUIREMENTT LESSONS LEARNED

Pilot comments on the cues available in several fighter airplanes are summarized in table XLVIII. Additional information on the F/A-18A at high angles of attack ("F/A-18A High Angle of Attack/Spin Testing") shows that it has inadequate buffet and natural stick force cues, though an α feedback in the control augmentation system provides a good artificial stick force cue. A warning tone is also employed.

Artificial warnings have proven to be inadequate on many aircraft. AFWAL-TR-81-3108 discusses the F/FB-111 in particular:

It was designed to have (and does have) the very best flying and ride qualities throughout its operational flight envelope. It is described as the Cadillac of military aircraft. This is accomplished largely through the incorporation of:

High-gain/authority command augmentation systems

Maneuver enhancement devices (automatic configuration changes)

Automatic series trim

As a result, the flying qualities pertaining to stick force, stick position, and aircraft motion remain essentially invariant until stall or departure occurs. There is little buffet and even this does not change appreciably with AOA. Thus, the aircraft suddenly falls off a "cliff." Three artificial cues -- a stick shaker, a horn, and panel lights -- are provided which activate at 14 deg AOA, well below the departure AOA of 20-21 deg. However, these have met with little success in preventing stalls and loss of control. A control system modification is now being retrofitted which will restore the needed stick force/position cues.

The FB-111 control system modifications include a stall inhibitor, a sideslip reducer, and an increase in stick force cues as the angle-of-attack limit is approached. This system can be defeated at low airspeed by various combinations of control inputs.

5.8.4.1 Warning cues-verification.

Verification shall be by analysis, simulation and flight test.

VERIFICATION RATIONALE (5.8.4.1)

Due to the complex nature of high-angle-of-attack flight, final demonstration of compliance with this requirement will necessitate flight testing. Wind-tunnel testing will give a preliminary indication of natural buffeting. If artificial warning cues are utilized, verification may include ground simulation. Pilots should evaluate the adequacy of the cues in operational-type maneuvering as well as in test stall approaches.

VERIFICATION GUIDANCE

The landing configuration at low weight may be critical because of a lower buffet intensity at the lower airspeed, or there may be less buffeting in the clean configuration.

VERIFICATION LESSONS LEARNED

Evaluation of pilot cues is inherently subjective. The warning should be evaluated by a number of pilots. If there is no consensus, acceptability should be based on adequacy for most service pilots in the intended missions.

MIL-STD-1797A
APPENDIX A

4.8.4.2 Stalls.

Stall is defined according to 3.4.2 (V_S) and 3.4.5 (α_S). The stall requirements apply for all Aircraft Normal States in straight unaccelerated flight and in turns and pullups with attainable normal accelerations up to n_L . Specifically to be evaluated are: _____. Also, the requirements apply to Aircraft Failure States that affect stall characteristics.

REQUIREMENT RATIONALE (4.8.4.2)

This introductory statement specifies the conditions to be considered in applying the stall requirements of 4.8.4.2.1, 4.8.4.2.2, 4.8.4.2.3 and 4.8.4.2.4.

REQUIREMENT GUIDANCE

The related MIL-F-8785C requirement is paragraph 3.4.2.1.

Recommended wording: the Aircraft Normal States associated with the configurations, throttle settings and trim settings of the V_S and α_S definitions; and the effects of loadings (4.1.1) and external stores (4.1.3). For Class I and IV aircraft, include inverted stalls.

The subparagraphs that fall under this statement contain qualitative and quantitative requirements pertaining to the stall. As AFWAL-TR-81-3109 concludes, stall classically corresponds to maximum lift coefficient, that is, $C_{L_\alpha} = 0$, but other accepted indicators of stall or maximum usable lift are also possible uncommanded motion in pitch, roll or yaw, or intolerable buffeting. Consonant with deletion of specific rules for establishing the Permissible Flight Envelope, MIL-F-8785C deleted mention that V_S and α_S may be set by conditions other than aerodynamic flow separation. Although the contractor may set the low-speed bound of the Permissible Flight Envelope arbitrarily, there is no need to state that here. Regardless of the boundary location, we would expect full stalls to be demonstrated if attainable -- not just for engineering satisfaction, but because in our experience the possible will occur. Note that, according to 4.8.4.1 and 4.1.8, adequate warning is required for both stalls and other dangerous flight conditions. That would include limits of the Permissible Flight Envelope, however they may be determined.

In terms of stall speed, aircraft performance is to be evaluated with respect to the stall speed or minimum permissible speed defined by flying qualities.

REQUIREMENT LESSONS LEARNED

The definitions of stall (3.4.2 and 3.4.5) include occurrence of "uncommanded pitching, rolling, or yawing." This also is a characteristic of (undesirable) departure. The difference between the two generally involves the energy state. The higher the energy state, the larger and more rapid the uncommanded motion. If uncommanded pitch, roll, or yaw defines both stall and departure, then some rate-of-motion boundary should be established between the two. At present there is insufficient information to define such a boundary except for the allowable "stall" excursions.

Abrupt uncommanded rolling or yawing could be especially critical in accelerated flight, where it is possible to pull rapidly through any stall warning or g-break, and into a departure. On the other hand, the wings of some current fighter designs exhibit no distinct "g-break" -- only progressive deterioration in drag and lift, with C_{L_α} remaining positive, as angle of attack continues to increase at full-scale Reynolds number. To penalize such designs seems unwarranted.

F/A-18 flight testing has shown that, in the absence of high-angle-of-attack natural airframe buffet, stick force, stick position or both are the desired (but still not entirely adequate) warning cues. A sharp increase in the stick force per degree α gradient at 22 deg (stall occurs at approximately 34 deg α , true) provides an acceptable high- α warning during normal maneuvering, but it does not provide the necessary pilot awareness of high or during aggressive maneuvering that can generate high pitch rates and undesirable α overshoots. An audio warning tone triggered at 35 deg α was also found to be unacceptable during aggressive maneuvering in that it did not provide pilot awareness of the aircraft's α and rate of change of α when tactically maneuvering below the warning tone threshold, specifically in the 20- to 30-deg α region. In general, F/A-18 test experience supports the guidance with respect to preferred stall warning

MIL-STD-1797A
APPENDIX A

cues (namely, stickforce/position) when natural airframe buffet warning cues do not provide adequate stall warning.

5.8.4.2 Stalls-verification.

Verification shall be by analysis, simulation and flight test.

VERIFICATION RATIONALE (5.8.4.2)

Due to the extremely nonlinear nature of stalls and stall warnings, final verification must be by flight test. Inaccurate knowledge of both aerodynamic nonlinearities and pilot acceptance criteria limit the confidence engendered by anything less than full-scale flight evaluation of stall characteristics. For this flight evaluation, MIL-S-83691A rightfully emphasizes control use and abuse representative of the most expected in service operation, with a careful buildup.

With adequate buildups, 4.8.4.2 - 4.8.4.2.4 will be flight-verified concurrently, in the same test series.

VERIFICATION GUIDANCE

The configurations, throttle settings and trim settings of 3.4.2 and 3.4.5 may be specified for investigation. Stalls should be performed with both gradual and rapid entries.

VERIFICATION LESSONS LEARNED

MIL-STD-1797A
APPENDIX A

4.8.4.2.1 Stall approach.

The aircraft shall exhibit the following characteristics in the stall approach:

- a. The onset of warning of stall approach (4.8.4.1) shall occur within the following speed range for 1-g stalls: _____, and within the following range (or percentage) of lift for accelerated stalls: _____, but not within the Operational Flight Envelope.
- b. An increase in intensity of the warning with further increase in angle of attack shall be sufficiently marked to be noted by the pilot. The warning shall continue until the angle of attack is reduced to a value less than that for warning onset. Prior to the stall, uncommanded oscillations shall not _____.
- c. At all angles of attack up to the stall, the cockpit controls shall remain effective in their normal sense, and small control inputs shall not result in departure from controlled flight.
- d. Stall warning shall be easily perceptible and shall consist of _____.

REQUIREMENT RATIONALE (4.8.4.2.1)

Approach to stall must always be clearly indicated to the pilot with a margin (airspeed or angle of attack) sufficient to recover from the incipient stall, yet small enough to be meaningful.

REQUIREMENT GUIDANCE

The related MIL-F-8785C requirements are paragraphs 3.4.2.1.1, 3.4.2.1.1.1, and 3.4.2.1.1.2

Recommended warning ranges:

1-g Stalls:

FLIGHT PHASE	MINIMUM SPEED FOR ONSET	MAXIMUM SPEED FOR ONSET
Approach	Higher of $1.05V_S$ or $V_S + 5$ knots	Higher of $1.10V_S$ or $V_S + 10$ knots
All other	Higher of $1.05V_S$ or $V_S + 5$ knots	Higher of $1.15V_S$ or $V_S + 15$ knots

Accelerated stalls:

FLIGHT PHASE	MINIMUM SPEED FOR ONSET	MAXIMUM SPEED FOR ONSET
Approach	82% of $C_{L_{stall}}$	90% of $C_{L_{stall}}$
All other	75% of $C_{L_{stall}}$	90% of $C_{L_{stall}}$

Even where the Operational and Service Flight Envelopes coincide, as they may at the low-speed boundaries, there should be sufficient margin from stall that warning should still be required to occur outside the Operational Flight Envelope.

A requirement limiting uncommanded oscillations [as in part b] is quite subjective: one pilot may want no uncommanded motion associated with approach to stall; while another might consider some such motion a necessary evil or even a cue of occasional value, and so find oscillations acceptable. The results of the

MIL-STD-1797A
APPENDIX A

piloted simulation of AFWAL-TR-80-3141 suggest that a noticeable "g-break" indicated stall while any aperiodic uncommanded motion (in any axis) of greater than 20 deg/sec signified departure. A suggested wording is "be so severe as to require the pilot's full attention to retain control in the maneuver."

For part d the recommended wording is, "buffeting or shaking of the aircraft, shaking of the cockpit controls, or both."

The accelerated-stall margins are in terms of $C_{L_{stall}}$ as in MIL-F-8785C. They correspond to the airspeed stall margins for unaccelerated flight. That was a change from Interim Amendment-1 (USAF), which used angle-of-attack margins in recognition of the very shallow lift-curve slope characteristic of low-aspect-ratio and swept wings in the stall approach region: our C_L margin corresponds then to a rather wide of margin, thus tending to restrict the usable angle of attack range more than may be necessary. Nevertheless, upon reflection we were convinced that (a) accelerated-stall warning requirements must be consistent with those for unaccelerated stalls (for which an airspeed margin is both rational and well accepted); and (b) the large $\Delta\alpha$ doesn't provide enough extra lift to warrant more special consideration. For fighter pilots who want to extract that last bit of g from their aircraft in a dogfight or dive pullout, the required progressive warning should help. Perhaps it could be supplemented by a tone or some other indication of nearness to stall angle of attack.

With limited aerodynamic design capability and inadequate data on pilot desires, more detailed specification of stall warning margins seems unwarranted. However, gaining pilot acceptance of dynamic stall warning may require some additional tailoring of the aircraft. Possibly the warning range desired for accelerated stalls would be mission-dependent (for example, air-to-ground vs. air-to-air), considering the average altitude available for recovery, the rapidity of speed bleedoff for the vehicle/weapon configuration, and departure susceptibility/severity. Data are insufficient to establish such mission-dependent criteria, and implementation on aircraft would be difficult, so the requirements of MIL-F-8785C have been retained.

REQUIREMENT LESSONS LEARNED

Adequate, timely warning is of paramount importance if the stall/post-stall characteristics are less than satisfactory. But even if there is an effective stall limiter, a pilot needs a readily perceived indication of approaching an aircraft limit.

See AFWAL-TR-80-3141 for more accounts of experience.

5.8.4.2.1 Stall approach-verification.

Verification shall be by analysis, simulation and flight test

VERIFICATION RATIONALE (5.8.4.2.1)

Stall speed as defined herein is a steady state. To determine V_S and α_S the stall approach should be made slowly to eliminate any dynamic effects. At the one knot per second rate called for by the FAR Parts 23 and 25, an airspeed somewhat lower than the present V_S may be reached before the stall break. Trial will determine a rate that is slow enough for the particular aircraft (FAR Part 25 landing approaches, however, are at 1.4 times the FAR stall speed; while MIL-C-5011 calls for landing approach at 1.3 times a somewhat higher V_S , which may be comparable to the FAR approach speed.) Nevertheless, rapid stall entries are also to be evaluated.

While wind-tunnel tests and analyses can provide estimates, final verification must be by flight test.

VERIFICATION GUIDANCE

Stall buffet will be less intense at lower speed, corresponding to lightweight and high-lift configurations (unless the high-lift configuration enhances the stall buffeting).

MIL-STD-1797A
APPENDIX A

Suitability of the warning should also be evaluated in operational conditions. Beyond low subsonic speeds, V_S and α_S are functions of Mach number.

VERIFICATION LESSONS LEARNED

MIL-STD-1797A
APPENDIX A

4.8.4.2.2 Stall characteristics.

The following requirements apply for all stalls, including stalls entered abruptly:

- a. In the unaccelerated stalls of 4.8.4.2, the aircraft shall not exhibit rolling, yawing or downward pitching at the stall which cannot be controlled to stay within _____ deg.
- b. It is desired that no pitch-up tendencies occur in stalls, unaccelerated or accelerated. However, in the unaccelerated stalls of 4.8.4.2 mild nose-up pitch may be acceptable if no pitch control force reversal occurs and no dangerous, unrecoverable or objectionable flight conditions result. In the accelerated stalls of 4.8.4.2. a mild nose-up tendency may be acceptable if the operational effectiveness of the aircraft is not compromised and the aircraft has adequate stall warning, pitch control effectiveness is such that it is possible to stop the pitch-up promptly and reduce the angle of attack, and at no point during the stall, stall approach, or recovery does any portion of the aircraft exceed structural limit loads.

REQUIREMENT RATIONALE (4.8.4.2.2)

In order for an aircraft to be controllable in a developed stall, uncommanded angular excursions must be of a manageable magnitude and, in the case of pitch excursions, should be in a direction that will enhance controllability.

REQUIREMENT GUIDANCE

The related MIL-F-8785C requirement is paragraph 3.4.2.1.2.

Recommended excursion limits are 20 deg for Classes I, II, and III and 30 deg for Class IV. These limits are on the amount of attitude change at stall.

The stated tolerance of mild pitch-up is a concession to allow configurations giving significant performance benefits not to be penalized unduly for their stall characteristics. The designer should make every reasonable attempt to avoid pitch-up or, failing that, to minimize it.

There is no mention of angular rates, which may be more important to the pilot at stall. The transients due to failure of the primary flight control system (4.2.6.2, 4.5.7.2, and 4.6.5.2) are recommended to be less than ± 0.5 g laterally or longitudinally and ± 10 deg/sec roll rate within 2 seconds. A similar constraint could be defined for unaccelerated stalls. For particular applications such as air combat fighters, the intended mission may dictate tighter limits, or even prohibit such excursions, whether open-or closed-loop.

REQUIREMENT LESSONS LEARNED

AFWAL-TR-80-3141 and AFFDL-TR-74-61 point out that cases exist in which a pilot's attempts at stabilization do not help, but actually induce instability. For example, with the A-7, aerodynamic coupling between longitudinal and lateral-directional motions while sideslipping is shown to be the cause of departure from controlled flight. Vehicle sideslip is not specifically mentioned in these requirements, it probably should be; some sideslip is common, even unavoidable at high angles of attack. Aircraft rarely have a decent zero-sideslip reference.

This requirement legislates against severe pitch-up tendencies, but some nonviolent pitch-down which can be arrested often is a desirable stall characteristic. For large (Class III) aircraft, excessive nose-down pitching is undesirable, according to AFWAL-TR-81-3108, because of:

... the very large inertias involved and the excessive altitude loss which is incurred before recovery. The regions where stall is most usually encountered may also be important, e.g., pitch down due to stall at cruise ceiling could lead to Mach overspeed while pitch down in the landing pattern could easily lead to a nonrecoverable dive. The preferred

MIL-STD-1797A
APPENDIX A

recovery sequence is to set the aircraft nose on the horizon, add full power, and wait for the aircraft to regain flying speed. The preferred metric is the dwell time between recovery initiation and regaining of flight speed. Altitude lost due to settling is less than that due to a diving recovery.

(This preference obviously depends on the drag characteristics at stall angle of attack.) The technique described is consistent with training procedures used for civil transport aircraft. For example, "Out of a Spin" describes the stall series used in 747 training and recurrent checks:

... a V_{ref} (final approach) speed is computed for the landing weight and a bug positioned next to this number on the airspeed gauge. The first stall is made clean with wings level, the next in a 20-degree bank with 10 degrees of flaps, and the third straight ahead with the gear down and landing flaps (30 degrees). In each exercise the engines remain spun up but at low thrust settings. These configurations approximate those seen in near-airport maneuvering.

The recovery from each is the same: at buffet or stick shaker, apply go-around thrust, lower the nose to five degrees above the horizon, and level the wings. When properly executed, the 747 will resume normal flight with little or no loss of altitude. Rough handling ensures a secondary buffet or shaker, or both, and substantial altitude loss.

5.8.4.2 Stall characteristics-verification.

Verification shall be by analysis, simulation and flight test.

VERIFICATION RATIONALE (5.8.4.2.2)

The flight test program should be conducted cautiously, with a buildup from less severe configurations, loadings, entries and failure states to more severe ones.

VERIFICATION GUIDANCE

Stall characteristics generally tend to deteriorate as the center of gravity moves aft. External stores may affect the aerodynamic or inertial characteristics significantly, and any asymmetries which can reasonably be expected should be test-flown.

The extent of required stall penetration during flight testing has been argued extensively. For one thing, civil and military definitions of V_S differ-see 4.8.4.2.1 guidance. For another, the desired degree of penetration depends to an extent on intended use, which may be more severe for military than for civil use. In general, even military cargo and transport aircraft should be taken at least to a stall break that is discernible on the flight records.

VERIFICATION LESSONS LEARNED

MIL-STD-1797A
APPENDIX A

4.8.4.2.3 Stall prevention and recovery.

The following requirements shall be met:

- a. It shall be possible to prevent the stall by moderate use of the pitch control alone at the onset of the stall warning.
- b. It shall be possible to recover from a stall by simple use of the pitch, roll and yaw controls with cockpit control forces not to exceed _____, and to regain level flight without excessive loss of altitude or buildup of speed. Throttles shall remain fixed until an angle of attack below the stall has been regained unless compliance would result in exceeding engine operating limitations.
- c. In the straight-flight stalls of 4.8.4.2, with the aircraft trimmed at an airspeed not greater than $1.4 V_S$, pitch control power shall be sufficient to recover from any attainable angle of attack.
- d. Operation of automatic departure/spin prevention or recovery devices and flight control modes shall not interfere with the pilot's ability to prevent or recover from stalls.

REQUIREMENT RATIONALE(4.8.4.2.3)

Except for practice or test, stalling is generally an unexpected and potentially dangerous event. Therefore recovery must be easy and instinctive.

REQUIREMENT GUIDANCE

The related MIL-F-8785C requirement is paragraph 3.4.2.1.3.

It is recommended that the control force limits of 4.8.3 be applied:

CONTROL TYPE	PITCH (lb)	ROLL (lb)	YAW (lb)
Sidestick	20	15	
Centerstick	50	25	
Wheel			
(two-handed tasks)	75	40	
(one-handed tasks)	50	25	
Pedal			175

Prevention of and recovery from the stall must always be simple for the pilot. MIL-F-8785C included the requirement that throttles remain fixed until "speed has begun to increase." This has been removed in recognition of the method of stall recovery used for both light trainer (Class I) and heavy (Class III) aircraft release back pressure on the wheel, lower the nose to the horizon, and add power--whether airspeed has begun to increase or not.

As long as the wing is unstalled, the addition of power will aid in flying out of the stall with minimal altitude loss. If stalling may produce engine flameout, however, recoveries with appropriate thrust (or lack of it) should also be investigated. Also note that control to balance propeller torque may limit the application of power for recovery at very low airspeed.

REQUIREMENT LESSONS LEARNED

A potential quantitative criterion for specifying stall recovery for Class III aircraft is dwell time (AFWAL-TR-81-3108). As mentioned in 4.8.4.2.2 guidance, this is the time between occurrence of the stall and recovery of flying speed. The criterion is in accordance with standard practice for stall recovery: keeping the nose at the horizon and adding thrust, rather than letting the nose fall through the horizon before thrust is applied.

MIL-STD-1797A
APPENDIX A

AGARD-CP-260 shows that for three Class III airplanes (S-3A, L-1011 and C-5A) maximum nose-down pitch acceleration at the stall was less than or equal to 0.08 rad/sec^2 for 90 percent of the stalls. It therefore suggests that a pitch recovery criterion could be that the pitch control produce $\ddot{\theta} > 0.08 \text{ rad/sec}^2$ at stall.

During stall testing of the F-16A/B with aft c.g, pitch-up to an upright deep stall was encountered, requiring a spin parachute for recovery. Figure 255 shows a time history of a deep stall. Analysis of the F-16 flight control system suggests that the deep stall condition may have been aggravated by anti-spin stability augmentation (SAS, figure 256) which is activated at $\alpha \geq 29 \text{ deg}$, combined with a longitudinal stick gain to remove the pilot from the loop. Figure 255 shows the point at which the anti-spin SAS became active ($t = 10 \text{ sec}$, δ_F is differential flaperon deflection). A lateral limit-cycle oscillation developed, possibly caused by the anti-spin SAS, and cross-axis coupling caused the aircraft to pitch to still higher a and subsequent deep stall, with full nose-down stabilator deflection.

Recovery from this deep stall (which might arguably be termed a post-stall gyration but certainly is prohibited by 4.1.11.5) without a spin chute requires a manual pitch override (MPO) in the longitudinal SAS (AFFTC-TR-79-18):

A manual pitch override system was installed in the test aircraft to allow pilot control of the stabilator in a deep stall condition (upright or inverted) and thus allow the aircraft to be "rocked out" of the deep stall.... This pitch override system required the pilot to hold a toggle switch, located on the left console, in the OVRD position during usage. The switch was spring loaded to the NORM position. When selected, the pitch override (a) eliminated the negative g limiter to allow TED stabilator control and (b) for AOA greater than or equal to 29 degrees, eliminated the AOA limiting and pitch integrator functions to allow trailing edge up (TEU) stabilator control.

An MPO switch is now included in production aircraft but, according to AFFTC-TR-79-18, its operational utility is questionable:

The MPO was an effective upright deep stall recovery device when utilized properly.... However, the ability of the operational pilot to properly and readily adapt to the usage of the MPO remains a concern. During flight tests with pilots who were extremely familiar with the deep stall environment, as many as four total cycles of the stick were required before an effective cycle was achieved. The primary difficulty encountered involved improper phasing with existing pitch oscillations. Proper phasing became much more difficult when severe roll oscillations existed. The rolling tendency (to as much as 90 degrees bank angle) masked the pitching motion of the aircraft.

Such phasing between stick and aircraft motion could be considered a violation of this requirement: that is, this is not a "simple" use of the pitch control. What is expedient as a "fix" is not necessarily acceptable for specification use.

5.8.4.2.3 Stall prevention and recovery-verification.

Verification shall be by analysis, simulation and flight test.

VERIFICATION RATIONALE(5.8.4.2.3)

Both stall approaches broken off at stall warning and complete stalls to an angle of attack great enough to identify V_s are to be performed-with caution and careful buildup, at a safe altitude, as with all high- α testing. Again, the degree of stall penetration depends to an extent on the intended use of the aircraft. On aircraft for which high- α testing does not proceed beyond the stall angle of attack, verification of control to recover from any attainable angle of attack may be by analysis of wind-tunnel data.

MIL-STD-1797A
APPENDIX A

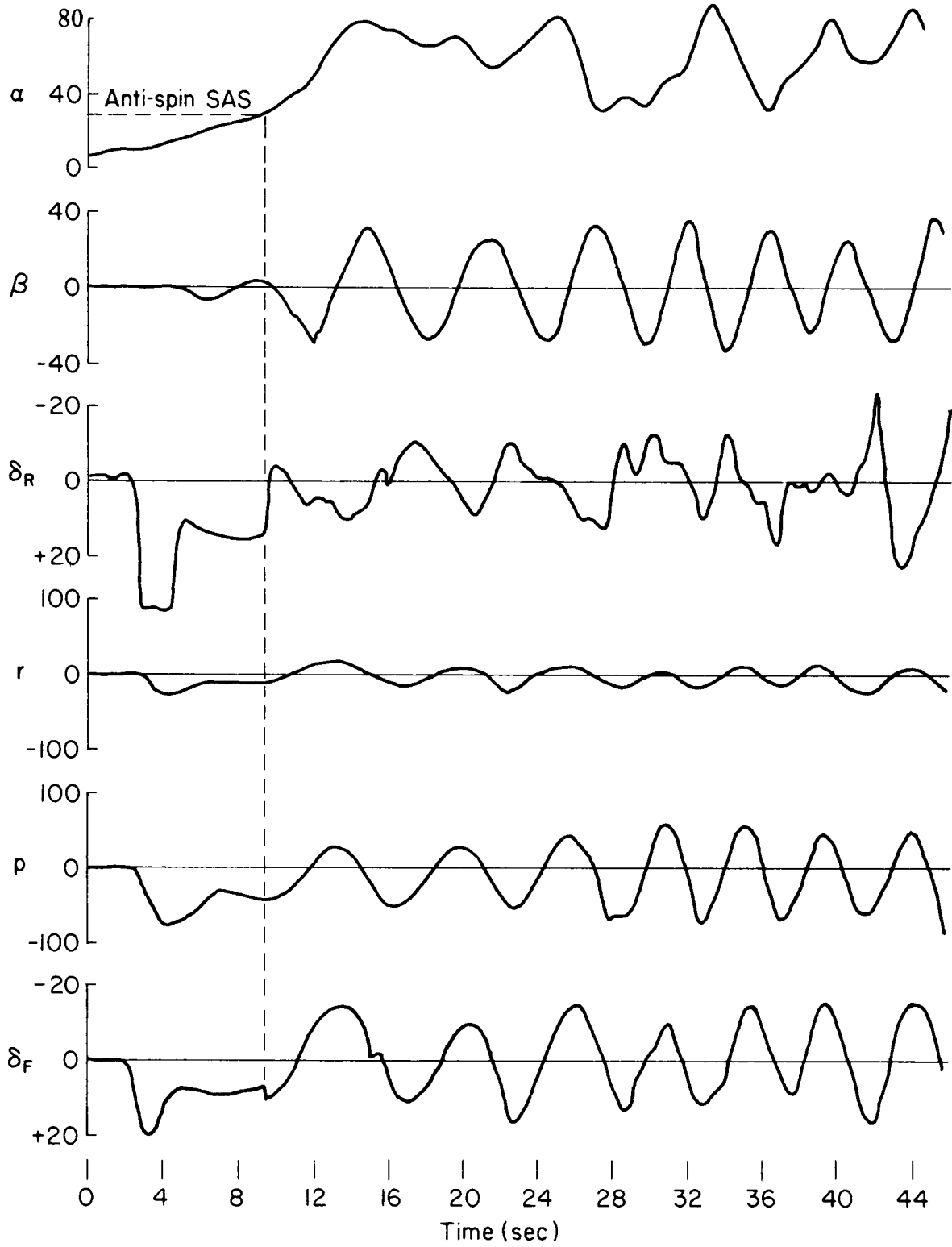

FIGURE 255. Time history of aft-c.g. deep stall encountered by F-16B

MIL-STD-1797A
APPENDIX A

(AFFTC-TR-79-18).

MIL-STD-1797A
 APPENDIX A

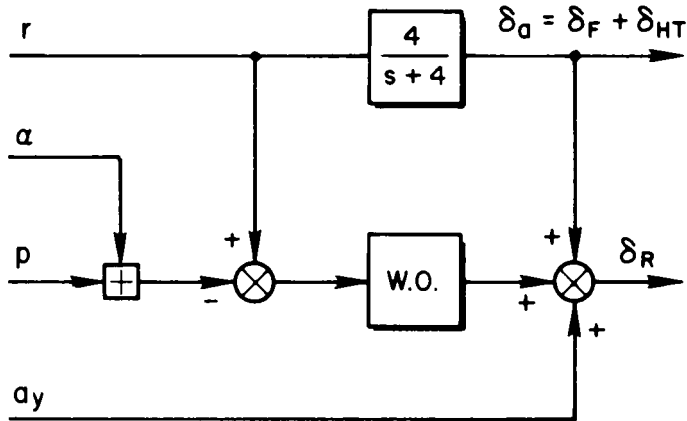

FIGURE 256. Anti-spin SAS for F-16B ($\alpha \geq 29$ deg).

VERIFICATION GUIDANCE

These and other high- α tests should be preceded by thorough study of available model test and simulation results for the particular aircraft.

VERIFICATION LESSONS LEARNED

MIL-STD-1797A
APPENDIX A

4.8.4.2.4 One-engine-out stalls.

On multi-engine aircraft it shall be possible to recover safely from stalls with the critical engine inoperative. Thrust on the remaining engines shall be at _____.

REQUIREMENT RATIONALE (4.8.4.2.4)

Some multiengine aircraft exhibit violent, unacceptable rolling or yawing tendencies in engine-out stalls, while the need to maximize aircraft performance for recovery from an engine failure increases the possibility of stalling.

REQUIREMENT GUIDANCE

The related MIL-F-8785C requirement is paragraph 3.4.2.1.3.1.

Loss of an engine in low-speed flight will often lead to a stall, especially in a critical Flight Phase such as takeoff. The large yawing and rolling moments produced by an engine-out situation can then induce a spin if recovery from the stall is not immediate.

For best application of this requirement the procuring activity may choose to specify the Flight Phases and thrust settings for testing. MIL-F-8785C includes the following table, recommended for use here:

FLIGHT PHASE	THRUST
TO	Takeoff
CL	Normal climb
PA	Normal approach
WO	Waveoff

For civil aircraft, FAR Part 25 requires that recovery be possible "with the remaining engines at up to 75 percent of maximum continuous power. or up to the power at which the wings can be held level with the use of maximum control travel, whichever is less"; FAR Part 23 is more severe in that it has the additional requirement that the airplane not display any undue spinning tendency during the single-engine stall demonstration.

Throttling back on the operative engine(s) during recovery is allowable.

REQUIREMENT LESSONS LEARNED

There is some evidence that stalls with one engine inoperative and the other(s) at high power have led to departures and, in some cases, an out-of-control flat spin. This has occurred on contemporary fighter aircraft as well as on light twin-engine aircraft, usually as a result of delayed recovery controls. It is conjectured that several C-133 aircraft lost at sea had suffered an engine failure at the start of long-range cruise, at or above the service ceiling, where stall margin is minimal; artificial stall warning, having been found undependable, was sometimes turned off; and poor roll control and a severe roll off accompanied stall, more so with only three engines.

5.8.4.2.4 One-engine-out stalls-verification.

Verification shall be by analysis, simulation, and flight test.

VERIFICATION RATIONALE (5.8.4.2.4)

The same precautions should be observed as in flight testing other stalls, only more so. These tests will normally follow the symmetric-thrust stalls, incrementally increasing good engine thrust on successive stalls.

MIL-STD-1797A
APPENDIX A

VERIFICATION GUIDANCE

Where propellers or fans direct airflow over the wing, the side with reduced thrust will generally stall first. Lateral control effectiveness may also be reduced by lessened dynamic pressure or even local stalling at the ailerons or spoilers.

VERIFICATION LESSONS LEARNED

MIL-STD-1797A
APPENDIX A

4.8.4.3 Post-stall gyrations and spins.

The post-stall gyration and spin requirements apply to all modes of motion that can be entered from upsets, decelerations, and extreme maneuvers appropriate to the Class and Flight Phase Category. Entries from inverted flight and tactical entries _____ be included. Entry angles of attack and sideslip up to maximum control capability and under dynamic flight conditions are to be included, except as limited by structural considerations. Thrust settings up to and including MAT shall be included, with and without one critical engine inoperative at entry. The requirements hold for all Aircraft Normal States and for all states of stability and control augmentation systems except approved Special Failure States. Store release shall not be allowed during loss of control, spin or gyration, recovery, or subsequent dive pullout. Automatic disengagement or mode-switching of augmentation systems and automatic flight control system modes, however, is permissible if it is necessary; re-engagement in the normal mode shall be possible in flight following recovery. Specific flight conditions to be evaluated are: _____.

REQUIREMENT RATIONALE(4.8.4.3)

The conditions for consideration of departure and recovery from post-stall gyrations and spins are delineated.

REQUIREMENT GUIDANCE

The related MIL-F-8785C requirement is paragraph 3.4.2.2.

Similar to the introductory requirement for stalls (4.8.4.2), the conditions to be considered are specified for departures and spins. The stated conditions are to be interpreted according to the intended missions, as reflected in the aircraft Class and Flight Phase Categories (see MIL-S-83691). For Class II and III aircraft the words "need not" should be inserted in the first blank. For Classes I and IV, insert "shall".

AFWAL-TR-81-3108 takes exception to the critical-engine-inoperative requirement:

The one-engine-inoperative requirement should not be a universal requirement. It may be a legitimate requirement for large multi-engine aircraft but not for twin-engine fighters where asymmetric thrust moments can exceed available control moments. Inadvertent loss of one engine during departures in the F- 14 invariably leads to a non-recoverable flat spin. In view of this catastrophic consequence we have kept the requirement. In considering a deviation, the question is how much of a design (or redesign) penalty is acceptable in order to fix the problem by increased control power, improved departure/spin characteristics or added recovery capability. (Of course, the critical-engine-inoperative requirement applies only to multiengine aircraft.)

REQUIREMENT LESSONS LEARNED

Older stall/spin requirements such as AAF Specification 1816 and MIL-S-25015 (USAF) emphasized determination of stall and spin modes. As a result of concern over a large number of aircraft losses in service, in 1970 the Air Force Flight Test Center undertook to write a new specification [MIL-S-83691 (USAF)] which would emphasize determination of the susceptibility to loss of control (departure) at high- α . Concurrently, MIL-F-008785A(USAF) was drafted to reflect this emphasis. With minor modifications these high- α requirements were incorporated in MIL-F-8785C and remain little changed through this current revision. The thrust is to make the requirements and verifications more closely representative of situations encountered in squadron operation.

Concern has been expressed over requiring unrealistic manhandling of large, low-load-factor aircraft. That is not the intent of either these flying qualities requirements or the flight test demonstration requirements of MIL-S-83691. Table I of MIL-S-83691A(USAF) lists required entries and aggravated control inputs graded by aircraft Class, with rather extensive instructions aimed at assuring appropriateness of the maneuvers.

MIL-STD-1797A
APPENDIX A

5.8.4.3 Post-stall gyrations and spins-verification.

Verification shall be by analysis, simulation, and flight test.

VERIFICATION RATIONALE (5.8.4.3)

If flight testing is required for verification of 4.8.4.3.1 and 4.8.4.3.2, the contractor must follow the guidelines of this requirement. For Class II and III aircraft, only the degree of departure susceptibility must be verified in flight; but in any case some post-stall analysis and model testing should be done. Possibilities include wind tunnel, free-flight model, drop model testing; determination of the effect of stability and control augmentation, including limiters; and simulation. Further flight testing, then, or curtailment of high- α testing, would depend on any deficiencies discovered.

VERIFICATION GUIDANCE

The degree of post-stall penetration is governed by the intended use of the aircraft. These flight characteristics are so dependent on the configuration that detailed prior analysis, model testing and simulation are needed to guide the flight verification program.

The factors to be considered are listed in the suggested departure rating scale (by definition, departure is a Cooper-Harper 10) from AFWAL-TR-80-3141, shown on figure 257. This departure rating must be accompanied with qualitative information which should include, as a minimum:

Warning

Type

Clarity

Margin

Departure

Resistance (susceptibility)

Type

Severity

Ability of pilot to delay or prevent

Control action taken

Demands on the pilot

Post-stall motion

Type of aircraft motion

Severity

MIL-STD-1797A
APPENDIX A

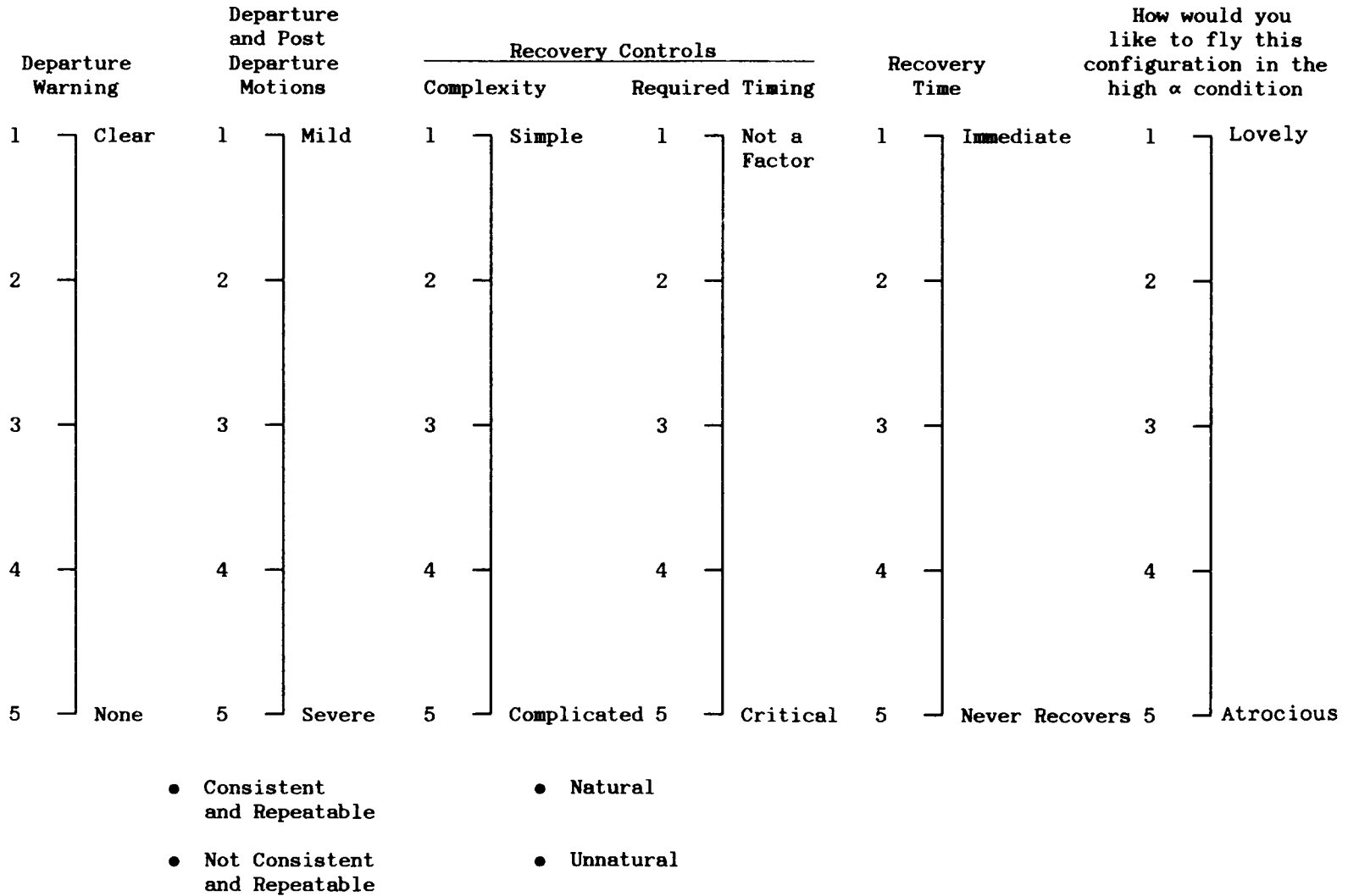

FIGURE 257. Modified departure rating scale (MOD II).

MIL-STD-1797A
APPENDIX A

Recovery

Rapidity

Recovery controls

Demands

Ability to recognize

Ability to perform necessary control action

AFWAL-TR-80-3141, ASD-TR-72-48, AFFDL-TR-78-171, and AFWAL-TR-81-3108 give more guidance on design criteria for departure resistance. Critical factors include $C_{n_{\beta,dyn}}$ (static directional stability modified by product-of-inertia effects), a Lateral Control Divergence Parameter (yawing moment due to roll control as a function of static directional and lateral stability), aerodynamic cross-axis coupling derivatives while sideslipping, and asymmetric nose-vortex shedding at zero sideslip.

VERIFICATION LESSONS LEARNED

It has not been uncommon to find that small configuration or mass changes, or even the addition of flight-test equipment (nose boom, spin chute), can change the post-stall behavior. While earlier models of the F-5 were quite benign at high angle of attack, increased stabilizer control authority in later models made loss of control somewhat easier. Some small changes to the contour of the wing-root leading-edge extension had a pronounced effect, as did altering the nose shape.

While spin-tunnel, rotary-balance and drop-model tests have been reasonably successful in predicting spin modes, there has not been quite as good success in predicting the aircraft's ability to get into some modes such as a flat spin.

See discussions on the deep stall characteristics of the F-16 ("Lessons Learned," 4.8.4.2.3) concerning the augmentation system effects on departure and modifications used for recovery.

The departure rating scale shown on figure 257 was used in an experiment conducted by NADC (NADC-85091-60) to investigate candidate departure criteria. This experiment was performed on the Dynamic Flight Simulator (DFS) and found inconsistencies in the pilot ratings especially with regard to "Departure Warning." It was concluded that a departure/no-departure cutoff would be beneficial as well as a better definition to the pilots of what is meant by a "clear" departure warning. In addition, more descriptors between the 1-5 ratings would make the scale more useable. These descriptors, however, should preserve the linearity of the scale. Another conclusion of that experiment was that it would be worthwhile to consider a more Cooper-Harper-like scale for departure in order to "lock" the pilot into a departure rating more consistently.

MIL-STD-1797A
APPENDIX A

4.8.4.3.1 Departure from controlled flight.

The aircraft shall be _____ resistant to departure from controlled flight, post-stall gyrations and spins. Adequate warning of approach to departure (4.8.4.1) shall be provided. The aircraft shall exhibit no uncommanded motion which cannot be arrested promptly by simple application of pilot control. At all angles of attack within the Operational Flight Envelope, following sudden asymmetric loss of thrust from the most critical factor, it shall be possible to avoid departure without exercise of exceptional pilot skill.

REQUIREMENT RATIONALE (4.8.4.3.1)

Departure resistance is a prime concern for high-angle-of-attack flight. So far it has been difficult to arrive at an agreed-upon method of predicting departure susceptibility.

REQUIREMENT GUIDANCE

The related MIL-F-8785 paragraph is 3.4.2.2.1.

The definitions of departure susceptibility and resistance from MIL-S-83691 are pertinent here:

Extremely susceptible to departure: departure from controlled flight will generally occur with the normal application of pitch control alone or with small roll and yaw control inputs.

Susceptible to departure: departure from controlled flight will generally occur with the application or brief misapplication of pitch and roll and yaw controls that may be anticipated in operational use.

Resistant to departure: departure from controlled flight will only occur with a large and reasonably sustained misapplication of pitch and roll and yaw controls.

Extremely resistant to departure: departure from controlled flight can only occur after an abrupt and inordinately sustained application of gross, abnormal, pro-departure controls.

On a pragmatic basis the normal requirement would be for an aircraft to be resistant to departure. If the high-at region is particularly important, the aircraft may be required to be extremely resistant. Provision has been left for additional quantitative requirements as knowledge improves. Also, the procuring activity may further designate that certain (training) aircraft shall be capable of a developed spin and consistent recovery--so that pilots will not experience such phenomena cold on some later aircraft.

The requirement is intended to apply to all aircraft. The terms large, reasonably sustained, abrupt, and inordinately sustained, however, are to be interpreted according to aircraft Class and mission. MIL-F-8785C required the airplane to be extremely resistant; we recommend reducing this in most cases to resistant. In the words of AFWAL-TR-81-3108, "The requirement of 'extremely resistant to departure' can be expected to dictate aircraft configuration or flight control system complexity, or both-precisely what the using commands warn against. Their preference is that the aircraft be departure/spin resistant." See also Lessons Learned, 4.8.4. Easing this requirement also allows for those (admittedly rare) occasions when pilots of Class IV aircraft want to use departure as a last-ditch evasive maneuver during air combat. The major difference, reflected in the definitions above, is in requiring "reasonably sustained application of ... controls" and "inordinately sustained application of gross, abnormal, pro-departure controls" for producing a departure. This difference should not be important except during air-to-air combat.

A requirement for a departure warning (see 4.8.4.1) reflects pilots' concerns. According to AFWAL-TR-81-3108,

Warning is needed which is separate and distinct from stall warning. Margins (maximum and minimum) between warning onset and actual departure should be dependent upon

MIL-STD-1797A
APPENDIX A

pitch control power (how rapidly the aircraft can transit the warning region), departure severity, spin susceptibility, and aircraft mission.

Several quantitative requirements were suggested in AFWAL-TR-80-3141. While there is insufficient support for incorporating them as such, they may be very useful for guidance in early analysis. A fixed-base piloted simulation of an F-4J found that:

...pilot perception of lateral-directional departure susceptibility is related to one zero of the numerator $N_{\delta_{stk}}^{\phi}$ [δ_{stk} is lateral stick, commanding ailerons and spoilers] becoming negative. Root magnitudes more negative than -0.5 rad/sec were consistently rated as departure-susceptible, while those less negative (or positive) are rated as departure-resistant. This criterion reflects a closed-loop divergence rate limit related to the pilot's threshold for uncommanded motion or ability to cope. As such it is a pilot-centered criterion which should be applicable for any flight situation, although it has been identified in a low-Mach-number, fixed-base simulation. It is consistent with the empirically established airframe-alone departure/spin criterion boundaries of Weissman [ASD-TR-72-48] and extends applicability of that criterion [Lateral Control Divergence Parameter, LCDP] to highly augmented airframe cases. It is also consistent with previous in-flight simulation of maximum controllable aperiodic divergence rates. Finally, it serves as both a design guide and a flying quality specification item.

The Lateral Control Divergence Parameter is defined, with stability-axis derivatives, as

$$LCDP = C'_{n_{\beta}} - \frac{C'_{n_{\delta_a}}}{C'_{l_{\delta_a}}} C'_{l_{\beta}}$$

Generally, LCDP should be greater than about -0.001. For the unaugmented airframe, according to AFWAL-TR-80-3141,

A value of $1/T_{\phi_1} = -0.5$ corresponds for the airframe tested to an effective LCDP of -0.001 and thus is consistent with and supports the empirically derived LCDP departure boundary developed by Weissman.

And, finally, a recommendation that no aperiodic uncommanded motion exceed 20 deg/sec was made, "based on a rough average of the simulation pilots' commentary as to their definitions of departure." This qualitative requirement is subject to the usual interpretation problems. There is a need for some limit between what is labeled a "stall" or a "departure."

5.8.4.3.1 Departure from controlled flight-verification.

Verification shall be by analysis, simulation, and _____.

VERIFICATION RATIONALE(5.8.4.3.1)

See FTC-TD-73-2 for a comprehensive discussion of considerations for a stall/post-stall/spin flight test program.

When the post-stall region is not banned by structural design considerations, flight testing is a necessity since it is difficult to define an accurate aerodynamic model for post-stall flight. In any simulation the procuring activity may prefer fixed-base over moving-base to avoid problems with confusing or unrealistic

MIL-STD-1797A
APPENDIX A

motions that might influence pilots' perceptions. Even for Class III aircraft, which will have no spin flight tests, stall/post-stall wind-tunnel tests and analysis are in order.

VERIFICATION GUIDANCE

Where allowed by the structural specification (for example MIL-A-8861). insert "flight test" in the blank.

Stall angle of attack (or $C_{L_{max}}$) is dictated by performance requirements. However, experience with the F-5 series aircraft and the F-15 leads to the conclusion that a sharp increase in longitudinal stability, starting slightly below stall angle of attack, allows the pilot full use of the transient pitch performance for air combat maneuvers. This aerodynamic characteristic limits angle-of-attack overshoots during abrupt pullup and rolling maneuvers. It also provides rapid recovery at low dynamic pressure with neutral pitch control. Though yaw departures occur in a limited portion of the flight regime, the F-15 does not continue into a spin but pitches down due to its inherent longitudinal stability at high angle of attack.

A configuration that is longitudinally unstable at or above stall is undesirable for Class IV aircraft. Angle-of-attack limiters are usually implemented in this case; limiters can be defeated, however, during low-speed maneuvers such as zoom climbs and high-angle-of-attack rolls. To preclude angle-of-attack overshoots as the limit is approached, a rate anticipation system is usually incorporated into the flight control system. This feature reduces the transient maneuvering performance of the vehicle. Pitching moment curves with a strong unstable break are poor for Class IV applications. When departure occurs, it is violent and can preclude safe ejection of the crew. Even if there is a large amount of nose down control power, the low dynamic pressure encountered as the aircraft pitches up results in slow nose down recovery.

Wind tunnel data that present rolling moment (C_ℓ) and yawing moment (C_n) as a function of angle of attack for zero sideslip should be evaluated to ensure that no excessively large moment values occur (e.g., from asymmetric vortex shedding from the nose) that could cause departures. The aerodynamic effect of the flight test boom, if located on the nose, should be determined.

Over the last decade an open-loop "Directional Divergence Parameter", $C_{n_{\beta_{dyn}}}$, has been extensively utilized. It has been partially successful in predicting departure susceptibility for several Class IV tactical jet aircraft, including the F-5E, A-10, F-15, YF-17 and F-18. $C_{n_{\beta_{dyn}}}$ is defined as follows, in terms of principal-axis stability derivatives:

$$C_{n_{\beta_{dyn}}} = C_{n_{\beta}} \cos \alpha - \frac{I_z}{I_x} C_{\ell_{\beta}} \sin \alpha$$

Figure 258, from Titiriga et al. in AGARD-CP-199, gives a Northrop criterion based on this parameter. Figure 259, from ASD-TR-72-48, presents Weissman's departure boundaries in terms of this and the LCDP already presented.

MIL-STD-1797A
APPENDIX A

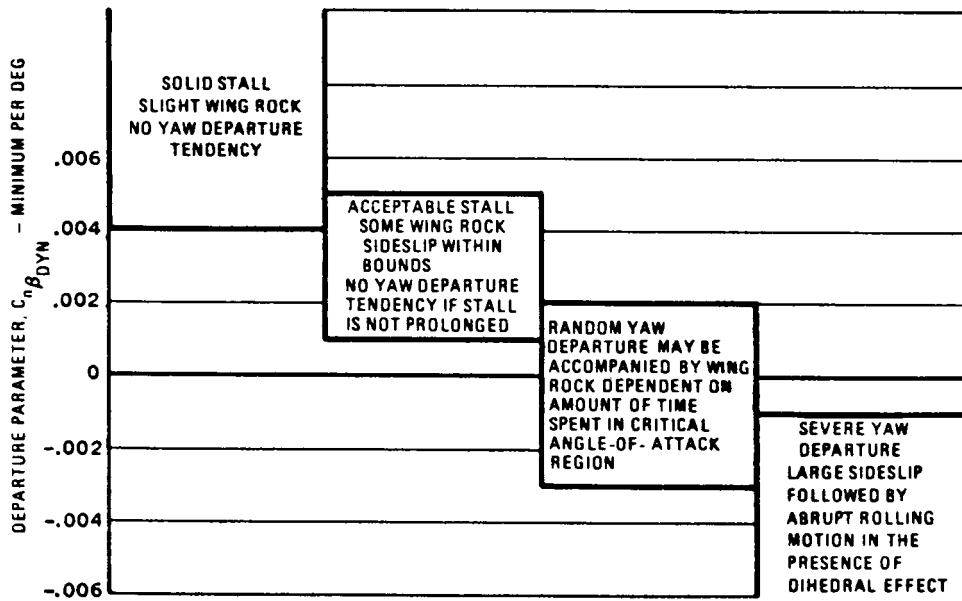

FIGURE 258. Dynamic stability design guide suggested by Titiriga (AGARD-CP-199).

These criteria should be evaluated at positive and negative angles of attack. For the F-15, the analyses of the LCDP resulted in a different control law at negative angle of attack than at high positive angle of attack. At high positive angle of attack, aileron and differential tail authority are reduced and rudder is put in to coordinate the roll. At negative angle of attack, rudder is used to uncoordinate the roll, due to a large increase in proverse yaw and a loss in dihedral effect at negative angle of attack.

A modified form of $C_{n\beta, dyn}$ was used during F/A-18 design to assess departure susceptibility with roll and yaw controls deflected. This parameter was defined as $C_{n\beta_{Apparent}}$:

$$C_{n\beta_{Apparent}} = \frac{C_n(\beta) + C_n(\delta)}{\beta} \cos \alpha - \frac{C_\ell(\beta) + C_\ell(\delta)}{\beta} \cdot \frac{I_z}{I_x} \sin \alpha$$

where $C_n(\beta)$ and $C_\ell(\beta)$ are the yawing and rolling moment coefficients due to the basic airframe at given angles of attack and sideslip, and $C_n(\delta)$ and $C_\ell(\delta)$ are the yawing and rolling moment coefficients due to one or more control surface deflections. It was used extensively in the design of the F/A-18 high- α lateral-directional control surface limits and control laws.

MIL-STD-1797A
APPENDIX A

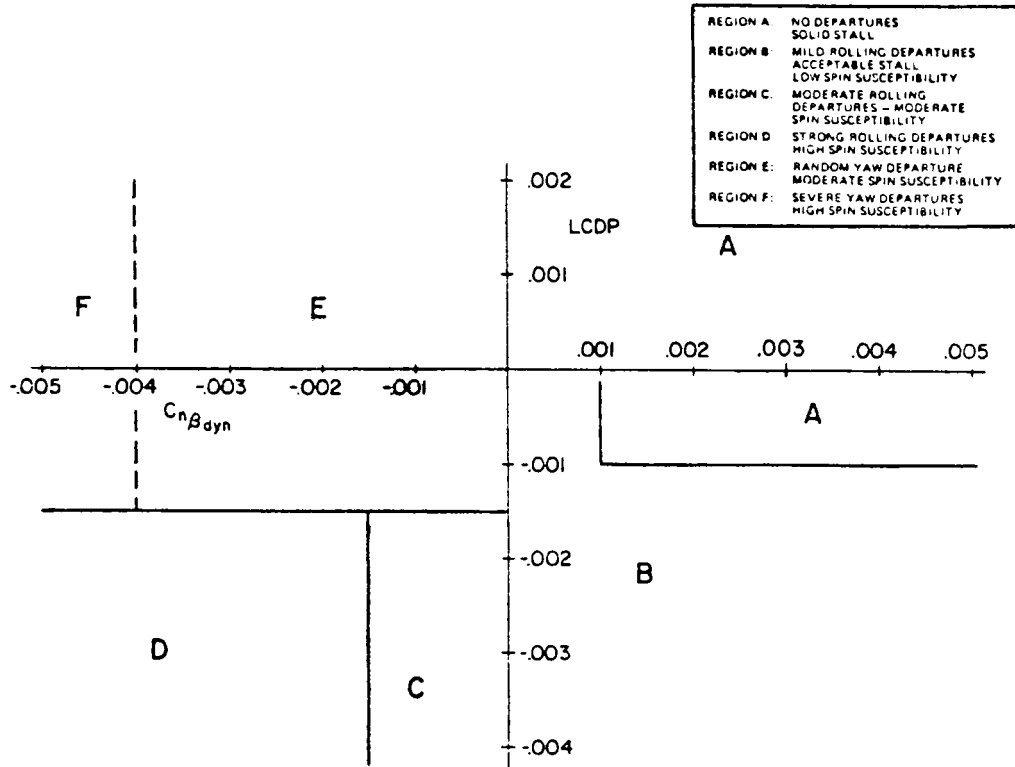

FIGURE 259. Departure and spin susceptibility criterion suggested by ASD-TR-72-48 and AFWAL-TR-80-3141.

It must be noted that these criteria only address a laterally symmetric aircraft. The criteria on C_n dynamic tends to alleviate the requirement for positive directional stability ($C_{n\beta}$) as long as dihedral effect is stable ($C_{\ell\beta}$ is negative). However, Class IV aircraft frequently encounter laterally asymmetric configurations due to the expenditure of wing mounted stores. The lateral asymmetry makes the aircraft more susceptible to departure and, if the asymmetry is large enough, more susceptible to spin. The application of C_n dynamic to the laterally asymmetric F-15 indicates that it is extremely resistant to departure for all angles of attack. even though C_n becomes unstable below the maximum trim angle of attack. This has been verified in flight test. However, as lateral asymmetry is increased, departure resistance degrades. The reason, as verified by flight test, is as follows. If a wings-level pullup is performed with an asymmetric configuration and no lateral control input, the aircraft rolls into the heavy wing, generating sideslip. The weight asymmetry prevents the stable dihedral effect from being effective, while the unstable level of directional stability generates a yawing moment away from the heavy wing. As sideslip increases, the rolling moment from dihedral takes effect. The resulting rolling and yawing moments generate a pitch acceleration through inertial coupling, and a departure and spin can develop. Strong directional stability beyond the stall would decrease this tendency and improve departure resistance with asymmetric loadings appropriate to the combat flight phase. It should be pointed out that other investigations have suggested different boundaries using these same static-based parameters (NADC-76154-30 and AFWAL-TR-81-3108). Therefore caution needs to be used when applying any of these methods and the analyst must clearly understand the development and assumptions of each criteria.

MIL-STD-1797A
APPENDIX A

Kalviste's approaches in terms of α - β carpet plots and coupled static stability derivatives, as reported for example in AGARD-CP-235 and AFWAL-TR-81-3108, have been found remarkably effective in assessing departure susceptibility (AFWAL-TR-82-3081).

The above approaches are not to replace rigorous 6-degree-of-freedom analyses of maneuvers appropriate to the mission and Flight Phase of the vehicle early in the design phase of the vehicle. An aggressive analytical approach to evaluate and design for departure resistance was taken for the F-5E, F-15, F-16, and YF-17 programs. This approach included obtaining good-quality wind tunnel data to 90 degrees angle of attack at $M = 0.2$ and above the stall angle of attack at $M = 0.6, 0.9$ and 1.2 . These data included longitudinal and lateral-directional stability and control data with store configurations. Due to aerodynamic nonlinearities at large positive and negative angles of attack, data points should be closely spaced (approximately 3 degrees apart in angle of attack and sideslip). These data were used to optimize flap schedules and evaluate buffet onset, and as input data for 5-degree and 6-degree-of-freedom analyses of large-amplitude maneuvers. The control laws were then determined and optimized for flying qualities and departure resistance. Maneuvers included bank-to-bank rolls at maximum angle of attack, rolls at negative angle of attack, pushovers, pullups, and other maneuvers chosen for analysis of departure and spin characteristics. The F-15 program also used free-flight model tests to evaluate departure and spin resistance. Low-Reynolds-number data were used to correlate with model drop tests. This provided confidence in the analyses of departure resistance that used high-Reynolds-number data. New wind-tunnel techniques to enhance our analyses capability are emerging. Rotary balance tests can be used to obtain the dynamic derivatives for a more accurate analysis of stall, departure and spin resistance. After these analyses are performed, manned simulation should be used to verify control laws, flying qualities and departure resistance prior to flight and as an adjunct to flight testing.

AGARD-CP-199 presents a number of aspects and views on stall/spin problems. Recent research contracts sponsored by the Air Force have generated information into the causes of departures and spins. Some of ADEL these are discussed in AFFDL-TR-78-171; examples of resulting reports include AFFDL-TR-74-61, AFWAL-TR-80-3141, ASD-TR-72-48, and AFWAL-TR-81-3108.

In the fixed-base piloted simulation of AFWAL-TR-80-3141, various maneuvers (bank-to-bank and windup turns, and pullups) were performed with and without a target aircraft. The simulated aircraft was based upon an F-4J, and aerodynamic parameters were varied to assess the effects of these parameters on handling qualities. Evaluations of departure susceptibility or resistance (based upon the MIL-F-83691 definitions) were different for the two pilots.

In closed-loop pilot/vehicle analysis it was found that flying techniques at high angles of attack were quite different for the two pilots. However, a correlating factor was found to be the value of one zero of the roll attitude numerator $N_{\delta_{stk}}^{\phi}$ where δ_{stk} simply indicates that lateral stick controls a combination of ailerons and rolling spoilers (of the six aerodynamic configurations evaluated, two included lateral augmentation with a stick-to-rudder interconnect as well). At high angles of attack and in asymmetric flight, AFWAL-TR-80-3141 shows that extreme adverse aileron yaw or lateral-longitudinal coupling can produce an "unstable" zero in the numerator. This zero may be first-order, or second-order if $\zeta_{\phi} < 1$, while the vehicle dynamics (i.e., $\zeta_p, \omega_p, \zeta_{sp}, \omega_{sp}, 1/T_R, 1/T_S, \zeta_d$ and ω_d) may all be acceptable. Thus, although the vehicle controls-free is stable, pilot attempts to control roll attitude can drive a pole into the right-half-plane zero, producing a closed-loop instability as shown in the following sketch:

MIL-STD-1797A
APPENDIX A

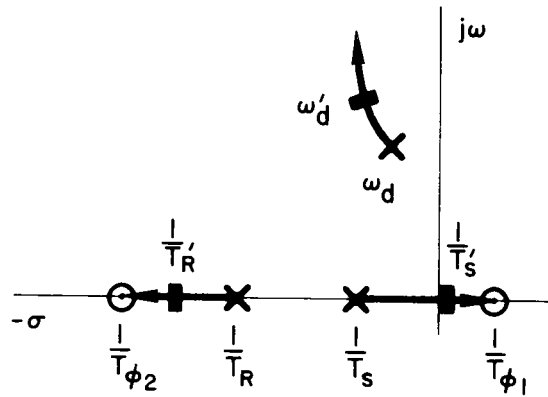

The AFWAL-TR-80-3141 simulation found strong correlation between the value of $1/T_{\phi_1}$ at departure and pilot evaluations of departure susceptibility, figure 260.

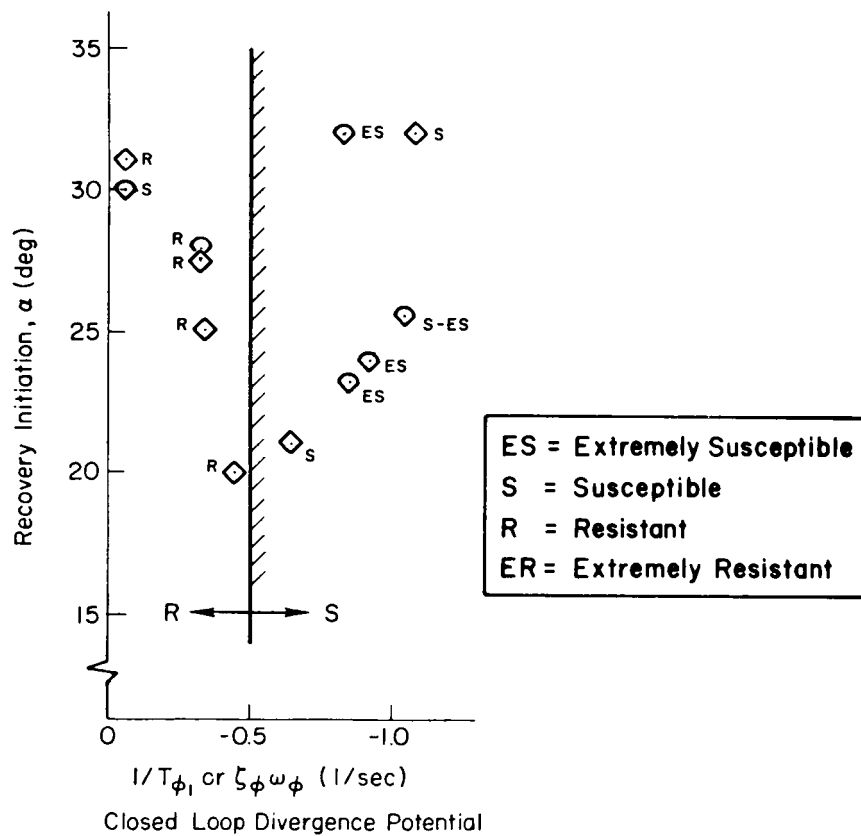

FIGURE 260. Departure susceptibility rating versus lateral closed-loop divergence potential (from AFWAL-TR-80-3141).

MIL-STD-1797A
APPENDIX A

For classical aircraft with no lateral-longitudinal coupling, the square of the $N_{\delta_{stk}}^{\phi}$ frequency term, ω_{ϕ}^2 [or $(1/T_{\phi_1})(1/T_{\phi_2})$] is approximated (Aircraft Dynamics and Automatic Control) by:

$$\omega_{\phi}^2 = N'_{\beta} - L'_{\beta} \frac{N'_{\delta_a}}{L'_{\delta_a}}$$

$$= \left(C'_{n_{\beta}} - C_{\ell_{\beta}} \frac{C'_{n_{\delta_a}}}{C'_{\ell_{\delta_a}}} \right) \frac{\bar{q}Sb}{I_z}$$

where the primed dimensional stability and control effectiveness derivatives are

$$L'_i = \frac{L_i + \frac{I_{xz}}{I_x} N_i}{1 - \frac{I_{xz}^2}{I_x I_z}}, \quad N'_i = \frac{N_i + \frac{I_{xz}}{I_z} L_i}{1 - \frac{I_{xz}^2}{I_x I_z}}, \quad C'_{\ell_i} = \frac{C_{\ell_i} + \frac{I_{xz}}{I_z} C_{n_i}}{1 - \frac{I_{xz}^2}{I_x I_z}}, \quad C'_{n_i} = \frac{C_{n_i} + \frac{I_{xz}}{I_x} C_{\ell_i}}{1 - \frac{I_{xz}^2}{I_x I_z}}$$

LCDP, which is defined by the bracketed expression above, is simply a nondimensional approximation for ω_{ϕ}^2 . In the AFWAL-TR-80-3141 evaluation, $1/T_{\phi_1}$ of -0.5 corresponded to LCPD of -0.001.

While these criteria should be helpful early in the design stage, they give only a first look. AIAA 87-2561 compares predictions with AV-8B flight results.

VERIFICATION LESSONS LEARNED

Although generally flight evaluations have been made with limiters operating, it has generally been found that these limiters could be defeated, tricked into allowing penetration to higher angles. Asymmetric loadings, either intentional or naturally occurring, can affect post-stall behavior. An increase in control power or decrease in stability (say, in pitch) can allow attainment of conditions theretofore unreachable. Engineering preparation for departure and spin tests should be done with care. Tasks include:

- a. Determination of recovery devices necessary for departure/spin program.
- b. Effect of these devices on the aerodynamic characteristics and inertial characteristics of the vehicle.
- c. The limits of operation of these devices.
- d. A sensitivity analysis of the aerodynamic characteristics and their influence on departure and spin susceptibility. This should be done on the manned simulator as it may influence the flight-test technique used to explore the angles of attack where unfavorable aerodynamic linearities are expected.
- e. Go- no-go criteria should be established; i.e., if a control surface position, sideslip angle, angle of attack or rate differs by a defined amount from a predicted value, then testing should be discontinued until further analysis is performed.

MIL-STD-1797A
APPENDIX A

4.8.4.3.2 Recovery from post-stall gyrations and spins.

The post-stall characteristics shall be determined. For all aircraft:

- a. The proper recovery technique (s) must be readily ascertainable by the pilot, and simple and easy to apply under the motions encountered.
- b. A single technique shall provide prompt recovery from all post-stall gyrations and incipient spins. The same technique, or a compatible one, is required for spin recovery. For all modes of spin that can occur, these recoveries shall be attainable within _____. Avoidance of a spin reversal or an adverse mode change shall not depend upon precise pilot control timing or deflection.
- c. Operation of automatic stall/departure/spin prevention devices and flight control modes shall not interfere with or prevent successful recovery of the aircraft by the pilot.
- d. Safe and consistent recovery and pullouts shall be accomplished without exceeding the following forces: _____, and without exceeding structural limitations.

REQUIREMENT RATIONALE (4.8.4.3.2)

Recovery from post-stall gyrations and spins must be possible and prompt, with simple control application. Even for aircraft in which flight demonstration is not feasible, the post-stall characteristics need to be known in order to give guidance for inadvertent encounters.

REQUIREMENT GUIDANCE

The related MIL-F-8785C requirement is paragraph 3.4.2.2.2.

Recommended values: Recovery should be specified in terms of allowable altitude loss or number of turns, measured from the initiation of recovery action:

CLASS	FLIGHT PHASE	TURNS FOR RECOVERY	ALTITUDE LOSS*
I	Category A, B	1-1/2	1000 ft
I	PA	1	800 ft
Other classes	PA	1	1000 ft
Other classes	Category A, B	2	5000 ft

* -Not including dive pullout.

For conditions that require control actions in more than one axis it is recommended that the forces specified by 4.8.3 be applied.

AFWAL-TR-81-3109 described the evolution of the MIL-F-8785 requirements:

Prior to Amendment 1 to MIL-F-8785B there had been no general requirements on post-stall gyrations, as distinguished from spins. MIL-F-8785B had only a reference to the then-current spin demonstration requirements of the Air Force (MIL-S-25015) and the Navy (MIL-D-8708). For aircraft to be spun, MIL-S-25015 required ready recovery from incipient and fully developed (5-turn) spins-1-turn spins for landing, 2 turns inverted. MIL-F-8785B Amendment 1 kept the MIL-S-25015 numbers of turns for spin recovery and added more bounds on altitude loss during recovery. The Class I requirements are similar to those of FAR Part 23 for the Aerobatic Category. Amendment 2 deleted all

MIL-STD-1797A
APPENDIX A

altitude bounds, on the premise that wing loading and drag are set by other considerations, leaving only turns for recovery to determine altitude loss, and that these bounds on turns for recovery could not reasonably be reduced further. Amendment 2 also deleted a number of Amendment 1's specifics on departure techniques, as well as an Amendment 1 requirement that the start of recovery be apparent within 3 seconds or one spin turn. Those specification features indicated desirable tests and characteristics, but added considerable detail in areas where design capability is lacking. That material is felt to be more pertinent to a flight demonstration specification such as MIL-S-83691.

Changes from MIL-F-8785C reflect pilots' views on spin recovery. The specification of recovery in terms of altitude loss, as in Amendment 1 of MIL-F-8785B, based upon what the pilot really is concerned about, was considered. For example, the piloted simulation of AFWAL-TR-80-3141 included an airplane model that would not spin, but showed a

... low-frequency wallowing that masks departure. At the same time, the wallowing does not generate sufficiently rapid motion to excite inertia cross-coupling and PSG. All pilots tended to continue fighting to maintain control well past full stall, incurring excessive altitude loss. However, if controls were released at any time the aircraft would immediately go into a nose-low spiral and recover by itself.

The high- α characteristics were otherwise considered quite good, but the excessive loss of altitude was unacceptable: "pilot commentary indicated the overall departure ratings were heavily influenced by altitude loss and mission phase." Specification of altitude loss was, however, deemed impractical.

AFWAL-TR-81-3108 also shows preference for an altitude-based metric:

Altitude loss per turn can vary drastically with different spin modes (e.g., steep versus flat), and a given vehicle may exhibit more than one spin mode. The allowable altitude loss, which is highly mission-related (e.g., air-to-ground versus air-to-air), appears to be a more appropriate recovery metric than turns for recovery.

But with rate of descent in a spin roughly proportional to wing loading, W/S , it would seem extremely difficult for a high- W/S fighter to recover in much less altitude than presently required. Ideally the altitude-loss requirement would also be a function of altitude above the ground, since a PSG at (say) 80,000 ft would not be as critical as one at 2000 ft above the ground. Although air density variations exert some influence on the motions, such a requirement is not felt to be practical.

This requirement will be verified in flight test only for aircraft that must be designed to withstand the forces of post-stall gyrations and spins. For other aircraft the requirement is only to determine that post-stall/spin characteristics are satisfactory, by appropriate wind-tunnel, spin-tunnel or free-flight model testing and analysis. This should provide some confidence in the pilots' handbook material and thus help to save the aircraft when they inadvertently get beyond the prescribed flight limits. The requirement then has implications for design of the structure and other subsystems. The procuring activity should weigh the benefits of assured recovery against any design penalties, so as not to unduly compromise the aircraft.

A recovery technique independent of the direction of motion-releasing or centering the controls, for example—is very desirable because pilots easily become disoriented in violent post-stall motions. Such recovery characteristics, however, may not be achievable without some automation. A "panic button" has been suggested.

REQUIREMENT LESSONS LEARNED

The F-4 series of airplanes serve as excellent examples of what is good and bad with this requirement. AFFDL-TR-70-155 summarizes a wide body of experience in spin testing of the F-4. The airplane was

MIL-STD-1797A
APPENDIX A

predicted by model tests to have steep erect and inverted oscillatory modes as well as a flat spin mode. AFFDL-TR-70-155 quotes flight-test reports concerning spin testing. For the F-4B,

A typical spin was initiated by applying pro-spin controls at the stall which resulted in the airplane yawing in the direction away from the applied aileron. After the initial yaw the airplane would pitch nose-down to about 60 deg to 80 deg at the 1/4 turn position followed by an increase in yaw rate. After 1/2 turn in yaw the airplane would pitch up to near level and in some cases 10 deg to 20 deg ANU, depending upon the energy conditions at entry. The yaw rate was usually at a minimum when the pitch attitude (and angle of attack) was at a maximum. The airplane was concurrently oscillating 60 deg in roll with no apparent relationship to pitch or yaw. The motions were extremely oscillatory for the first 2 to 3 turns. After 3 to 4 turns steady-state conditions were approached and although the oscillations remained, the amplitude and period became constant.... Pro-spin controls were held for up to 4-1/2 turns. The characteristics of the spin were similar for both left and right spins; however, each spin was different in some aspect from the others even under apparently identical entry conditions.

Standard recovery from incipient and developed spins was consistent and effective in all but flat spins. Also the recovery requirement was not met, since the pilot had to determine the direction of motion and timing was critical:

The recovery technique used after one turn in the incipient stage and in the fully developed spin was full aft stick, full rudder against the spin, and full aileron with the spin. This technique would generally affect recovery in 1/2 to 1-1/2 turns The primary visual cue that recovery had been effected was the cessation of yaw. As the yaw rate stopped, the controls had to be neutralized rapidly to prevent a reversal. The time at which controls were neutralized was critical. If controls were neutralized before the yaw rate ceased, the airplane would accelerate back into the spin ..., and if they were not neutralized within the one second after the yaw rate stopped, the spin direction would reverse ... in most cases, the recovery was indistinct because of residual oscillations, particularly in roll. Even though the yawing had been arrested and the angle of attack was below stall the aircraft would roll up to 540 deg in the same direction as the terminated spin. The residual oscillations were easily mistaken for a continuation of the spin.

A flat spin led to loss of the airplane (figure 261). The airplane was stalled with throttles idle and pro-spin controls. It entered a post-stall gyration, but did not progress to an incipient spin. "After 15 seconds the pilot attempted to terminate the post-stall gyration by neutralizing the rudder and aileron and by placing the stick forward of neutral," control motions in keeping with the requirement that the recovery not be dependent on determination of the direction of motion. However, according to AFFDL-TR-70-155,

A left yaw rate developed, and the airplane entered a left incipient spin. After 1-2 turns the oscillations diminished and the flat spin mode became apparent. Anti-spin controls were applied but had no significant effect on the spin characteristics. The drag chute was deployed at 33,000 ft, but again it streamed, did not blossom, and had no effect on the spin. At 27,000 ft the emergency spin recovery chute was deployed, but it also streamed. As a last resort the flight controls were cycled in an attempt to induce oscillations in the spin motions and/or to change the wake characteristics between the airplane and the spin chute. The only apparent effect of the control cycling was an increase in yaw rate to above 100 deg/sec.

MIL-STD-1797A
APPENDIX A

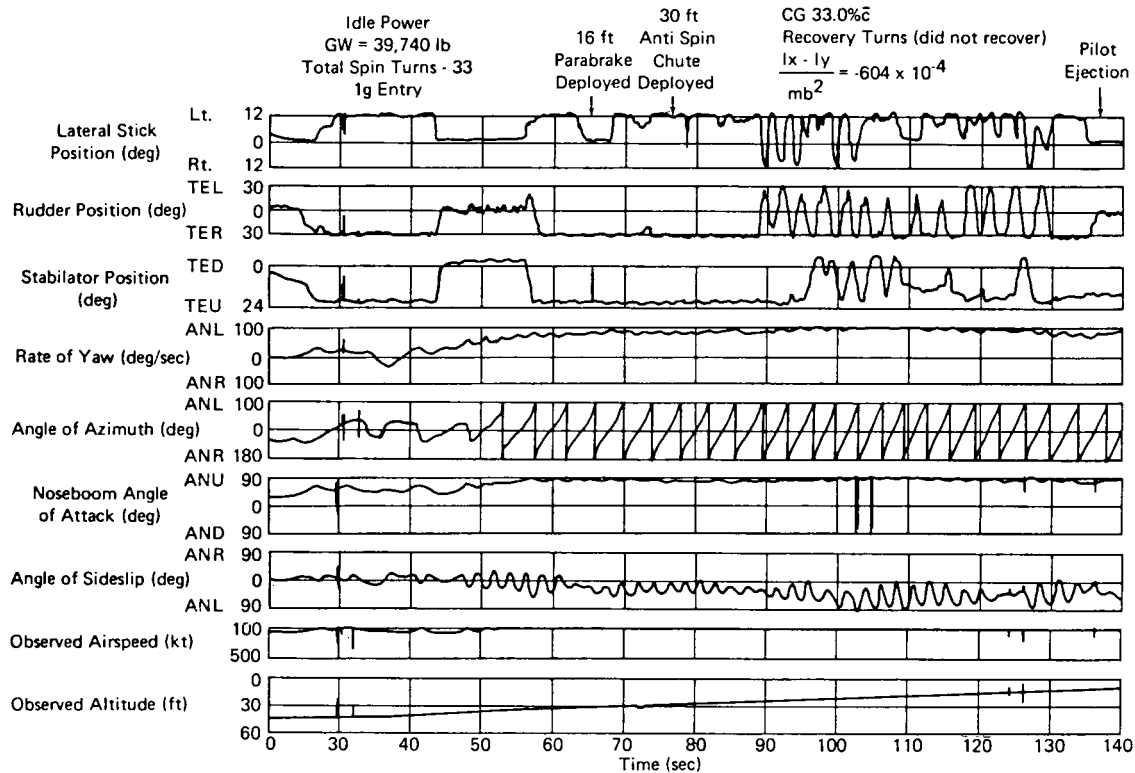

FIGURE 261. Left flat spin, F-4B (from AFFDL-TR-70-155).

These results serve to emphasize the importance of approaching spin testing with great care.

Recovery from the F-16 deep stall ("Lessons Learned," 4.8.4.2.3) required both a manual pitch SAS override switch and proper application of longitudinal stick to "rock" the airplane out of the stall—an action which required the pilot to determine the direction of motion, albeit in pitch and not yaw.

High-angle-of-attack testing of the F-18 ("F/A-18A High Angle of Attack/Spin Testing") has uncovered spin modes not unlike those of the F-4:

A low yaw rate spin was identified using asymmetric thrust to force the entry. It was characterized by yaw rates between 20 deg and 40 deg/second, an angle of attack between 50 deg and 60 deg, a steep nose-low attitude, and fairly smooth pitch and roll rates.

An oscillatory intermediate mode with yaw rates between 50 deg and 80 deg/second and an angle of attack between 60 deg and 80 deg.

A smooth flat mode at 90 deg to 140 deg/second yaw rate with an angle of attack between 80 deg and 85 deg.

The latter two modes were entered by defeating the Control Augmentation System (CAS) and removing all feedback control limiting.

MIL-STD-1797A
APPENDIX A

During these tests, 150 entries were attempted with over 100 resultant spins. Since the low- α mode could be entered with CAS on, a manual CAS defeat switch was installed to allow pilot access to maximum control authority for recovery. Using this switch and lateral stick into the spin, a single recovery technique was identified for all three spin modes.

The low mode spin has an aspect like the F-16's deep stall, and recovery with a CAS defeat switch is similar. Again, recovery from all three spin modes required determination of the direction of motion to apply lateral stick into the spin.

The F-16 and F-18 have fly-by wire control systems incorporating (respectively) manual pitch override or spin recovery mode switches which change the SCAS feedbacks. However, flight test experience has shown that employment of this type of technology can lead to difficulties associated with the anti-spin flight control system mode interfering with or delaying post-stall-rotation spin recovery. As noted earlier, automatic engagement of the F-16 anti-spin stability augmentation system may have aggravated the deep stall condition. For the F/A-18, the flight control system is designed to automatically revert to the ASRM if in a low-yaw-rate spin. The pilot is given anti-spin control authority should he desire to use it—anti-spin control inputs are not automatically applied. During initial F/A-18 operational evaluation testing, an F/A-18 crashed in a low-yaw-rate spin because the ASRM did not engage and provide the pilot with full anti-spin control authority. Also, there were occurrences during which the special cockpit displays for spin recovery provided incorrect information. There are no specific requirements presently with regard to the safe operation of automatic/manual post-stall recovery modes of a flight control system or of associated display operation. Some points to consider are:

Engagement/disengagement thresholds of automatic spin recovery flight control modes should be designed such that they do not inhibit or prevent recovery.

Displayed recovery information should always present the correct flight control system status (e.g., mode) and recovery control information.

From practical considerations there are no altitude-loss requirements placed on recovery except that characteristics be determined. A successful spin test was completed on the F-15 clean and with external stores. Recovery was defined as an absence of yaw rate and a steadily decreasing angle of attack at an angle of attack of 20 degrees. Data was cut off. It was later found out that recovery to a safe airspeed in level, controlled flight varied with store loading. When the aircraft was configured with stores, it wallowed more during recovery and took significantly more altitude to regain flying speed than the clean configuration. Furthermore, the pilots recommend slower control inputs during the dive pullout than with the clean configuration. Such information should be determined as a part of analysis and test, and incorporated into the pilot's manual.

5.8.4.3.2 Recovery from post-stall gyrations and spins-verification.

Verification shall be by analysis, simulation, and _____.

VERIFICATION RATIONALE (5.8.4.3.2)

In addition to analysis, common verification techniques include high- α wind tunnel tests (e.g. in the NASA Ames 12 ft wind tunnel) which has a rotary mount in addition to a high- α sting), free-flight model tests in the NASA Langley Full-Scale tunnel, drop-model tests with a more or less elaborate flight control system. and (where structural design permits) flight testing. Tests at NASA facilities, such as the Langley spin tunnel, of course need NASA approval. The procuring activity should see that contractually, results of all such testing are to be made available to their project office.

MIL-STD-1797A
APPENDIX A

VERIFICATION GUIDANCE

Detailed analysis and model testing should precede flight verification, to determine the characteristics of the particular design. Conditions investigated will be those of 5.8.4.3.1.

VERIFICATION LESSONS LEARNED

A wide variety of test philosophies has been applied to recent aircraft. Of course the severity of control abuse is a function of the aircraft type and missions. There has been controversy in applying the qualitative guidance of MIL-S-83691. For fighters, testing generally has progressed to the stage of finding ways to defeat any limiters, without turning them off. The F-18 test program went further, exploring limiters-off behavior. The first high-a tests of the Mirage 2000 were made with the limiter off because the pilots didn't trust limiters. But the F-15 spun nicely after just manipulating the stick to trick the limiter into allowing large pro-spin control surface deflections. For the F-15, loading asymmetries (internal fuel, external stores) caused significant variations in spin characteristics.

Small changes in aerodynamic or inertial configuration have in some cases profoundly affected entry or recovery characteristics. While there are those who for safety rely completely on analysis and model test to predict recoverability prior to flight test (for example the Mirage 2000, Mathe in AGARD-CP-333), in this country we have insisted on an additional recovery device for flight verification: a spin chute or spin recovery rockets. The latter have been used on the T-28 and supplemental spin testing on the F-100. Care must be taken that the recovery device does not change the aircraft motion characteristics.

MIL-STD-1797A
APPENDIX A

4.9 Flying qualities requirements in atmospheric disturbances

4.9.1 Allowable flying qualities degradations in atmospheric disturbances.

Levels and qualitative degrees of suitability of flying qualities as indicated in 3.3 are used to tailor the requirements to abnormal conditions such as flight outside the Operational Flight Envelope and Aircraft Failure States, as well as normal conditions. Abnormalities may also occur in the form of large atmospheric disturbances, or some combination of conditions. For these factors a degradation of flying qualities is permitted as specified herein:

a. In atmospheric disturbances the minimum required flying qualities for Aircraft Normal States are as specified in table V.

TABLE V. Flying qualities in atmospheric disturbances for Aircraft Normal States.

ATMOSPHERIC DISTURBANCES	WITHIN OPERATIONAL FLIGHT ENVELOPE	WITHIN SERVICE FLIGHT ENVELOPE
LIGHT TO CALM	_____	_____
MODERATE TO LIGHT	_____	_____
SEVERE TO MODERATE	_____	_____

b. In atmospheric disturbances the minimum required flying qualities for Aircraft Failure States are as specified in table VI.

TABLE VI. Flying qualities in atmospheric disturbances for Aircraft Failure States.

ATMOSPHERIC DISTURBANCES	FAILURE STATE I*	FAILURE STATE II**
LIGHT TO CALM	_____	_____
MODERATE TO LIGHT	_____	_____
SEVERE TO MODERATE	_____	_____

* Failure State I: _____

** Failure State II: _____

For this purpose, atmospheric disturbances are defined separately for high (above \approx 1750 ft) and low altitudes: _____

Crosswind intensities at touchdown are defined as: _____.

Required wind-shear capability is: _____.

MIL-STD-1797A
APPENDIX A

REQUIREMENT RATIONALE(4.9.1)

This requirement provides a rational means for specifying the allowable degradation in handling qualities in the presence of increased intensities of atmospheric disturbances. It is especially important to stress applicability in atmospheric disturbances because most flight testing is done in calm air. There is considerable evidence that atmospheric disturbances can expose handling qualities cliffs which are not apparent in calm air (for example, see FAA-RD-75-123).

REQUIREMENT GUIDANCE

The related MIL-F-8785C requirements are paragraphs 3.8.3.1 and 3.8.3.2.

TABLE LII. Recommended values for table V.

ATMOSPHERIC DISTURBANCES	WITHIN OPERATIONAL FLIGHT ENVELOPE	WITHIN SERVICE FLIGHT ENVELOPE
LIGHT TO CALM	Quantitative requirements Level 1; qualitative requirements Satisfactory	Quantitative requirements Level 2; qualitative requirements Acceptable or better
MODERATE TO LIGHT	Quantitative requirements Level 1; qualitative requirements Acceptable or better	Quantitative requirements Level 2; qualitative requirements Controllable or better
SEVERE TO MODERATE	Qualitative requirements Controllable or better	Qualitative requirements Recoverable* or better

* Recoverable: control can be maintained long enough to fly out of the disturbance.

MIL-STD-1797A
APPENDIX A

TABLE LIII. Recommended values for table VI.

ATMOSPHERIC DISTURBANCES	FAILURE STATE I*	FAILURE STATE II**
LIGHT TO CALM	Quantitative requirements Level 2; qualitative requirements Acceptable or better	Quantitative requirements Level 3; qualitative requirements Acceptable or better
MODERATE TO LIGHT	Quantitative requirements Level 2; qualitative requirements Acceptable or better	Quantitative requirements Level 3; qualitative requirements Controllable or better
SEVERE TO MODERATE	Qualitative requirements Controllable** or better	Qualitative requirements Recoverable*** or better

- * For flight in the Operational Flight Envelope:
Probability of encountering degraded Levels of flying qualities due to failure(s) < 10^{-2} /flight
- ** For flight in the Operational Flight Envelope:
Probability of encountering degraded Levels of flying qualities due to failure(s) < 10^{-4} /flight, and
For flight in the Service Flight Envelope:
Probability of encountering degraded Levels of flying qualities due to failure(s) < 10^{-2} /flight
- *** Recoverable: control can be maintained long enough to fly out of the disturbance. All Flight Phases can be terminated safely, and a waveoff or go-around can be accomplished.

For use with the generic analysis approach of 4.1.7.4, the aircraft failure states defined by the contractor (4.1.7) shall be grouped into Failure States I and II for use with respect to the requirements of table VI as follows:

Failure State I - Those failure states that result in a degradation in flying qualities to Level 2/Acceptable in calm air.

Failure State II - Those failure states that result in a degradation in flying qualities to Level 3/Controllable in calm air.

Failure states that do not normally result in a degradation in flying qualities in calm air due to redundancy or reconfiguration strategies shall meet the requirements of table V for normal states.

Recommended turbulence intensities:

The recommended rms magnitude of turbulence at high altitudes (from approximately 2000 ft above ground level up) are given in figure 262. These magnitudes apply to all axes. The dashed lines, labeled according to probability of encounter, are based on MIL-A-8861A and MIL-F-94901). The solid lines approximate this model, except that a minimum rms magnitude of 3 ft/sec is specified at all altitudes in order to assure that aircraft handling will be evaluated in the presence of some disturbance.

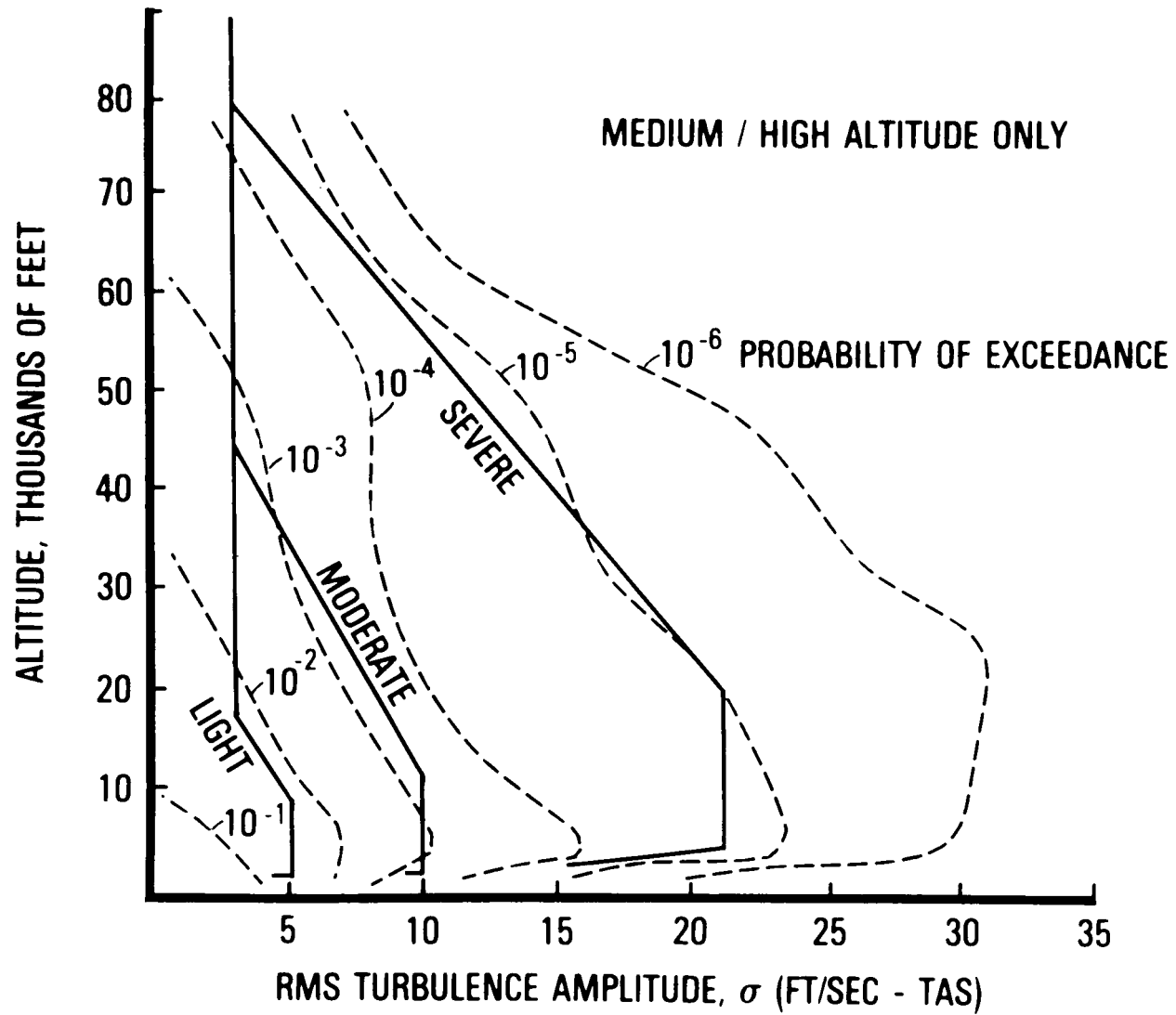

FIGURE 262. Turbulence severity and exceedance probability.

MIL-STD-1797A
APPENDIX A

At low altitudes the recommended rms intensity of vertical turbulence, σ_w , is related to the mean wind as commonly measured 20 ft above ground level, u_{20} :

$$\sigma_w = 0.1 u_{20}$$

where u_{20} is given in figure 263.

The recommended horizontal components, σ_u and σ_v , are as defined in 4.9.2.

Recommended crosswind values 20 ft above ground level are:

ATMOSPHERIC DISTURBANCE INTENSITY	STEADY CROSSWIND
Light	0 - 10 kt
Moderate	11 - 30
Severe	31 - 45

For the control power requirements, crosswind values are to be taken as invariant with altitude.

Recommended wind shear capability:

Decreasing headwind:	$g\gamma_{\max}$ up to 3.4 ft/sec ²
Increasing headwind:	$g\gamma_{\min}$ up to 1.7 ft/sec ²
Vector shear:	9 deg/sec with wind speed of 20 kt
Duration of all shears:	at least 10 seconds

where γ_{\max} is the climb angle at maximum power in the configuration used, at wind shear initiation; γ_{\min} is the flight path angle for flight idle thrust in the configuration, at wind shear initiation.

An alternative, when 4.1.7.4 is used instead of the probabilistic approach of 4.1.7.3, is to tabulate the requirements for combinations of disturbances and specific failures.

Somehow the flying qualities specification must incorporate the universal recognition that pilot workload or performance or both generally degrade as the intensity of atmospheric disturbances increases. MIL-F-8785C did this by tables XVI and XVII, paragraphs 3.8.3.1 & 2, for Normal and Failure States, respectively; we have continued that approach. Quantitative Level boundaries are applied in calm, Light and Moderate disturbances; while most of the data base includes that much consideration of environmental disturbances, no basis in data or reason could be found for applying the quantitative requirements generally in Severe conditions. In these tables the qualitative descriptions of required flying qualities are functions of Flight Envelope (Operational or Service), degradation due to Failure States (Normal, $P < 10^{-4}$, $P < 10^{-2}$) and atmospheric disturbance intensity. These qualitative descriptions are a rough fit to the Cooper-Harper scale. But now by direct comparison of adjacent blocks in the tables we see that the quantitative requirements are not uniquely related to the qualitative descriptions or to the Cooper-Harper scale. Indeed, for these environmental variations they cannot be.

MIL-STD-1797A
APPENDIX A

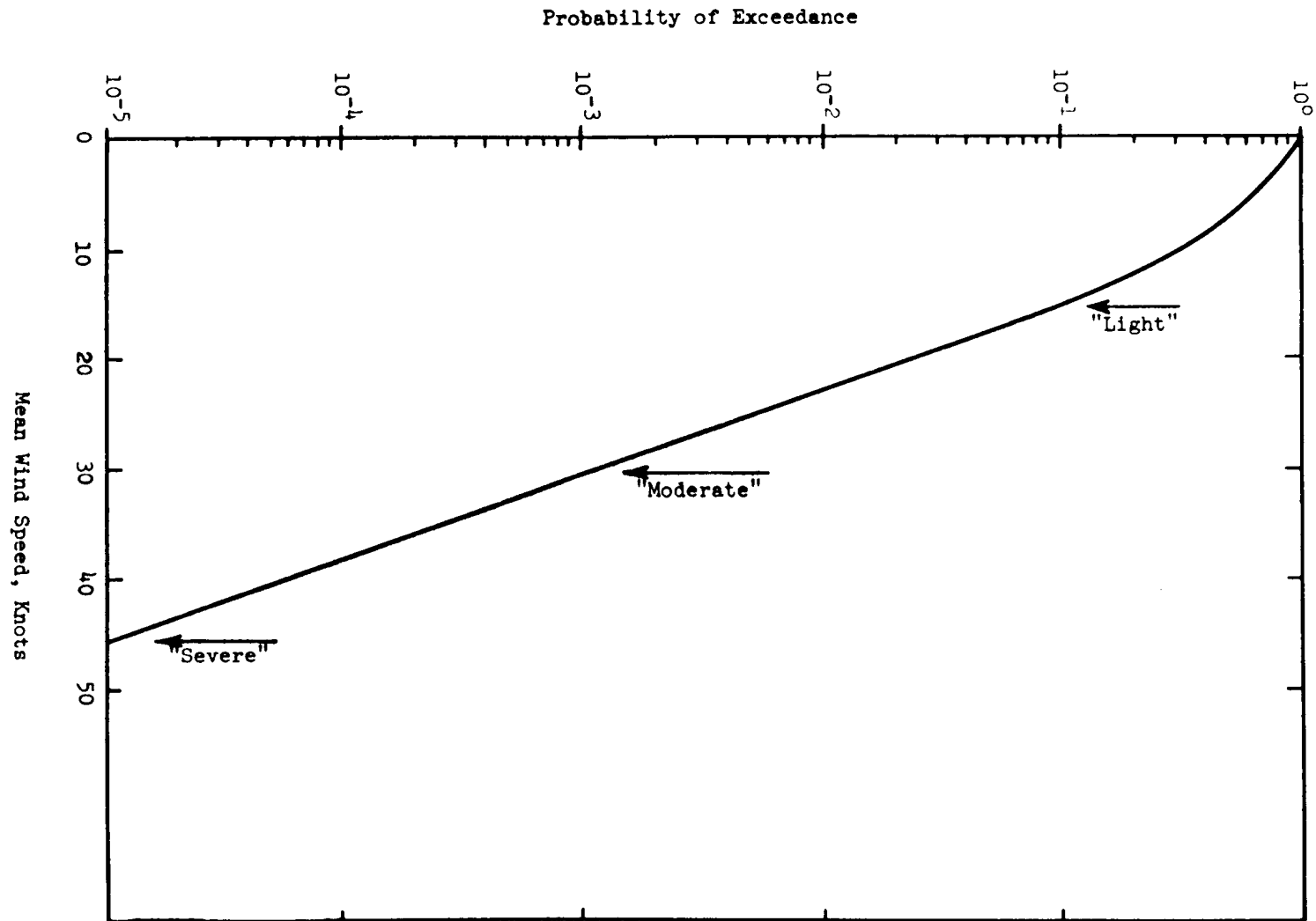

FIGURE 263. Probability of exceeding mean wind speed at 20 ft.

MIL-STD-1797A
APPENDIX A

Hoh et al. (AFWAL-TR-82-3081) proposed a somewhat different, finer-grained relation of requirements to disturbances, in terms of Cooper-Harper ratings. For the reasons stated above and in connection with 3.5 "Levels and qualitative degrees of suitability" we do not want so direct a tie to the Cooper-Harper scale. A rating difference of 1 is in the normal scatter band. Also we do not believe the available data warrant any finer breakdown. However, the procuring activity should assess both the disturbance intensities and the allowable degradations in the light of the aircraft's expected operational employment.

In some cases the expected motions due to turbulence are sufficiently extreme that pilot ratings are not appropriate. In these cases statements relating to survivability are used in both tables V and VI.

Rationale for choosing the magnitudes of wind shear which are included in the definition of Moderate atmospheric disturbances is discussed under 4.9.2.

The concept of accounting for degradations in flying qualities in a flying qualities specification was introduced in AFFDL-TR-78-171 and discussed at some length in the flying quality workshops held in 1978 and 1979 at the USAF Flight Dynamics Laboratory (AFFDL-TR-78-171 and AFWAL-TR- 80-3067). A primary objection has been that it is impractical to measure turbulence in flight test. A successful example of such measurements is given by NASA-TN-D-7703.

Any description of disturbance intensity in terms of aircraft reaction misses the point the reaction varies according to aircraft characteristics, and it is just that which we need to specify. Defining flying qualities in terms of a response intensity is a tautology, meaningless as a requirement. That leaves the question of how to determine the turbulence level in flight. Direct measurement should often be possible using the flight test instrumentation and parameter identification. Lacking that, one can estimate turbulence by using a chase plane with well-known gust response characteristics.

Finally, the discrete wind shear magnitude prescribed is based on aircraft performance. The basic rationale is that the handling qualities should be adequate to allow the pilot to operate up to the limit of performance (see, for example, NASA-CR-152064). In order to hold constant airspeed in a wind shear the aircraft inertial speed must be changed at the same rate as the changing wind, i.e., $\dot{V}_i = \dot{V}_w$. The maximum acceleration capability of an aircraft is not always well known. However, it can be obtained from performance charts by noting that $mg(\gamma_{max} - \gamma_0)$ is the change in weight component along the flight path which corresponds to a thrust increase to the maximum available, where γ_{max} is the maximum-power angle of climb at the reference speed in the configuration being investigated (for example, gear down and landing flaps for power approach); γ_0 is the trim flight path angle. Then

$$\dot{V}_{max} = g(\gamma_{max} - \gamma_0)$$

An upper limit on \dot{V}_w of 3.4 ft/sec ($\Delta\gamma = 6$ deg) has been specified to avoid requiring excessive shear for high-performance fighters where γ_{max} may be extreme.

REQUIREMENT LESSONS LEARNED

5.9 Flying qualities requirements in atmospheric disturbances-verification

5.9.1 Allowable flying qualities degradations in atmospheric disturbances-verification.

Verification shall be by analysis, simulation, and flight test.

VERIFICATION RATIONALE (5.9.1)

Experience has shown that the atmospheric disturbance environment which we have labeled as "Moderate" is generally sufficient to force the pilot into the aggressive control activity that we expect to expose handling deficiencies when they exist. Hence, it is recommended that in simulation the major effort be spent investigating the "Moderate" disturbance level. Similarly, during flight test there is no compelling reason to seek out mountain waves or thunderstorms to comply with the "Severe" and "Extreme" requirements stated in this requirement. Of course, if the mission specifically dictates flight in severe disturbances a significant portion of the time, these conditions should be duly accounted for in demonstrating compliance. In any case some flying should be done in turbulence as a general check of simulation.

VERIFICATION GUIDANCE

There may be aerodynamic and flight control system nonlinearities that are affected by very large disturbances. Such effects should be investigated analytically and in manned simulation with the severe and extreme magnitudes of atmospheric disturbances specified in table LIII.

When demonstrating compliance via piloted simulation, the steady crosswind values may be invariant with time, position or altitude. In flight test it is only necessary that the crosswind component specified exist at altitudes high enough to require the pilot to establish a definite crosswind correction prior to touchdown.

VERIFICATION LESSONS LEARNED

4.9.2 Definition of atmospheric disturbance model form.

When compliance is to be shown using piloted simulation, an atmospheric disturbance model appropriate to the piloting task shall be included. As a minimum, the atmospheric disturbance model shall consist of

REQUIREMENT RATIONALE (4.9.2)

This requirement gives the disturbance model to be utilized in analysis and simulation.

REQUIREMENT GUIDANCE

The related MIL-F-8785C requirements are 3.7.1, 3.7.2, 3.7.3, and 3.7.4.

Recommended requirement:

1. Form of the disturbance models

Where feasible, the von Karman form shall be used for the continuous turbulence model so that the flying qualities analyses will be consistent with the comparable structural analyses. When no comparable structural analysis is performed or when it is not feasible to use the von Karman form, use of the Dryden form will be permissible. In general, both the continuous turbulence model and the discrete gust model shall be used.

The scales and intensities used in determining the gust magnitudes for the discrete gust model shall be the same as those in the Dryden turbulence model.

a. Turbulence model (von Karman form)

The von Karman form of the spectra for the turbulence velocities is:

$$\phi_{u_g}(\Omega) = \sigma_u^2 \frac{2L_u}{\pi} \frac{1}{[1 + (1.339L_u\Omega)^2]^{5/6}}$$

$$\phi_{v_g}(\Omega) = \sigma_v^2 \frac{2L_v}{\pi} \frac{1 + \frac{8}{3}(2.678L_v\Omega)^2}{[1 + (2.678L_v\Omega)^2]^{11/6}}$$

$$\phi_{w_g}(\Omega) = \sigma_w^2 \frac{2L_w}{\pi} \frac{1 + \frac{8}{3}(2.678L_w\Omega)^2}{[1 + (2.678L_w\Omega)^2]^{11/6}}$$

b. Turbulence model (Dryden form)

The Dryden form of the spectra for the turbulence velocities is:

$$\phi_{u_g}(\Omega) = \sigma_u^2 \frac{2L_u}{\pi} \frac{1}{1 + (L_u\Omega)^2}$$

$$\phi_{v_g}(\Omega) = \sigma_v^2 \frac{2L_v}{\pi} \frac{1 + 12(L_v\Omega)^2}{[1 + 4(L_v\Omega)^2]^2}$$

$$\phi_{w_g}(\Omega) = \sigma_w^2 \frac{2L_w}{\pi} \frac{1 + 12(L_w\Omega)^2}{[1 + 4(L_w\Omega)^2]^2}$$

MIL-STD-1797A
APPENDIX A

Table LIV gives a summary of the recommended digital filter implementation of the Dryden turbulence components.¹⁴

c. Discrete gust model

The discrete gust model may be used for any of the three gust-velocity components and, by derivation, any of the three angular components.

The discrete gust has the "1 - cosine" shape given by:

$$v = 0 \quad x < 0$$

$$v = \frac{V_m}{2} \left(1 - \cos \frac{\pi x}{d_m} \right), \quad 0 \leq x \leq d_m$$

$$v = V_m \quad x > d_m$$

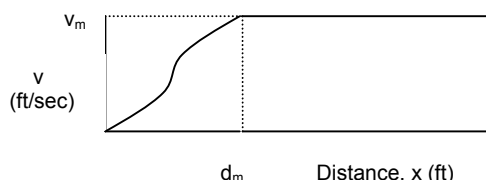

The discrete gust above may be used singly or in combinations in order to assess airplane response to, or pilot control of, large disturbances. For example, the discrete gust above might be coupled with an equal but opposite gust beginning at d_m , or an opposite half-wave of equal probability timed to excite an aircraft response mode. Step function or linear ramp gusts may also be used.

Alternatively, specific discrete gust data that have been extracted from gusts actually encountered during air vehicle flight tests are available. These may also be included in the definition of the atmospheric disturbance model for evaluation of air vehicle response. Figure 264 presents one such actual discrete gust profile.

2. Medium/high-altitude model

The scales and intensities are based on the assumption that turbulence above 2,000 feet is isotropic. Then

$$\sigma_u^2 = \sigma_v^2 = \sigma_w^2$$

and $L_u = 2L_v = 2L_w$

¹⁴ The Dryden turbulence power spectra given are the MIL-F-8785C spectra corrected for a factor of two (AFFDL-TR-72-41). The digital filter implementation of table LIV is for the Dryden form of this standard.

MIL-STD-1797A
APPENDIX A

TABLE LIV. Digital filter implementation.

COMPONENT	INTENSITY	BREAK FREQUENCY	DIGITAL FILTER FINITE DIFFERENCE EQUATION
U_g	$\sigma_u = \sigma$	$a_u = \frac{V}{L_u}$	$u_g = (1 - a_u T)u_g + \sqrt{2a_u T} \frac{\sigma_u}{\sigma_\eta} \eta_1$
V_g	$\sigma_v = \sigma$	$a_v = \frac{V}{L_u}$	$v_g = (1 - a_v T)v_g + \sqrt{2a_v T} \frac{\sigma_v}{\sigma_\eta} \eta_2$
W_g	$\sigma_w = \sigma$	$a_w = \frac{V}{L_u}$	$w_g = (1 - a_w T)w_g + \sqrt{2a_w T} \frac{\sigma_w}{\sigma_\eta} \eta_3$
p_g	$\sigma_p = \frac{1.9}{\sqrt{2L_w b}} \sigma_w$	$a_p = \frac{2.6}{\sqrt{2L_w b}}$	$p_g = (1 - a_p T)p_g + \sqrt{2a_p T} \frac{\sigma_p}{\sigma_\eta} \eta_4$
q_g	$\sigma_q = \sigma$	$a_q = \frac{\pi V}{4b}$	$q_g = (1 - a_q T)q_g + \frac{\pi}{4b} (w_g - w_{gPAST})$
r_g	$\sigma_r = \sigma$	$a_r = \frac{\pi V}{3b}$	$r_g = (1 - a_r T)r_g + \frac{\pi}{3b} (v_g - v_{gPAST})$

* p_g is significant only if $\sqrt{\frac{b}{2L_w}} C_{lp} > C_{lp}$

** q_g is significant only if $\sqrt{\frac{\pi b}{16L_w}} C_{mq} > C_{mq}$

† r_g is significant only if $\sqrt{\frac{\pi b}{12L_v}} C_{nr} > C_{nr}$

MIL-STD-1797A
APPENDIX A

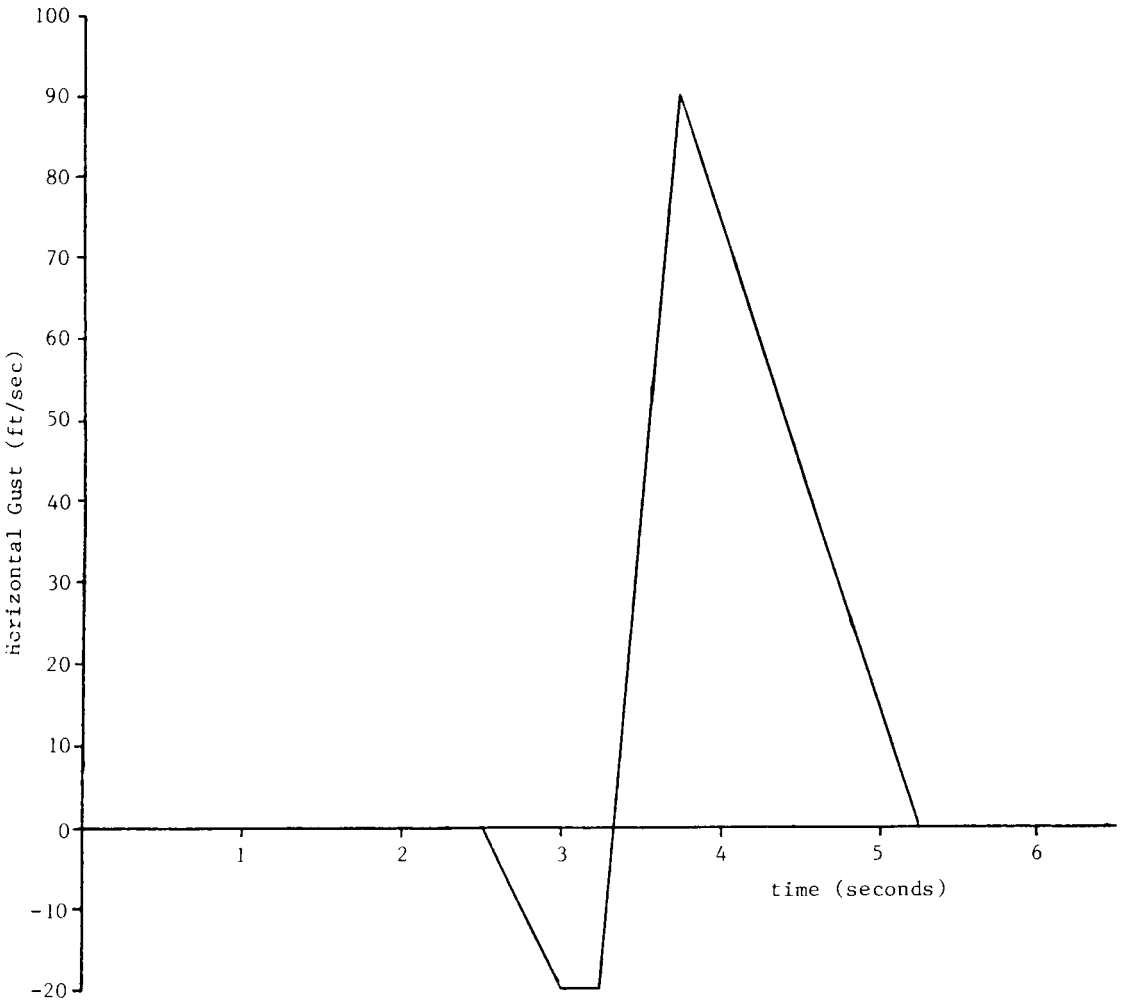
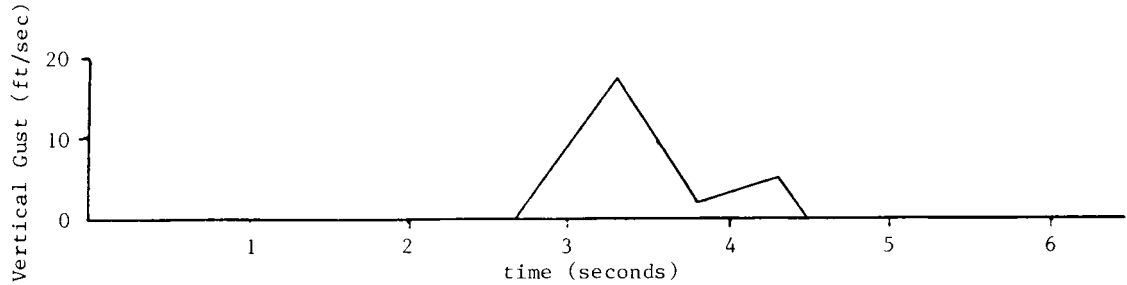

FIGURE 264. Earth-axis winds.

MIL-STD-1797A
APPENDIX A

a. Turbulence scale lengths

The scales to be used are

$L_u = 2L_v = 2L_w = 2,500$ feet using the von Karman form or

$L_u = 2L_v = 2L_w = 1,750$ feet using the Dryden form.

b. Turbulence intensities

Root-mean-square turbulence intensities are shown on figure 262 as functions of altitude and probability of exceedance. Simplified variations for application to the requirements of this standard are indicated.

c. Gust lengths

Several values of d_m shall be used, each chosen so that the gust is tuned to each of the natural frequencies of the airplane and its flight control system (higher frequency structural modes may be excepted). For the Severe intensities, modes with wavelengths less than the turbulence scale length may be excepted

d. Gust magnitudes

The Light and Moderate gust magnitudes u_g, v_g, w_g shall be determined from figure 265 using values of d_x, d_y, d_z determined according to c., above, and the appropriate RMS turbulence intensities from figure 262. Severe gust magnitudes shall be:

- 1) 66 ft/sec EAS at V_G , gust penetration speed
- 2) 50 ft/sec EAS at V_{0max}
- 3) 25 ft/sec EAS at V_{max}
- 4) 50 ft/sec EAS at speeds up to V_{max} (PA) with the landing gear and other devices which are open or extended in their maximum open or maximum extended positions
- 5) For altitudes above 20,000 feet the gust magnitudes may be reduced linearly from:
 - a) 66 ft/sec EAS at 20,000 feet to 38 ft/sec EAS at 50,000 feet for the V_G condition
 - b) 50 ft/sec EAS at 20,000 feet to 25 ft/sec EAS at 50,000 feet for the V_{0max} condition
 - c) 25 ft/sec EAS at 20,000 feet to 12.5 ft/sec EAS at 50,000 feet for the V_{max} condition
- 6) For altitudes above 50,000 feet the equivalent gust velocity specified at 50,000 feet shall be multiplied by the factor $\sqrt{\frac{\rho}{\rho_{50000}}}$, the square root of the ratio of air density at altitude to standard atmospheric density at 50,000 feet.

MIL-STD-1797A
APPENDIX A

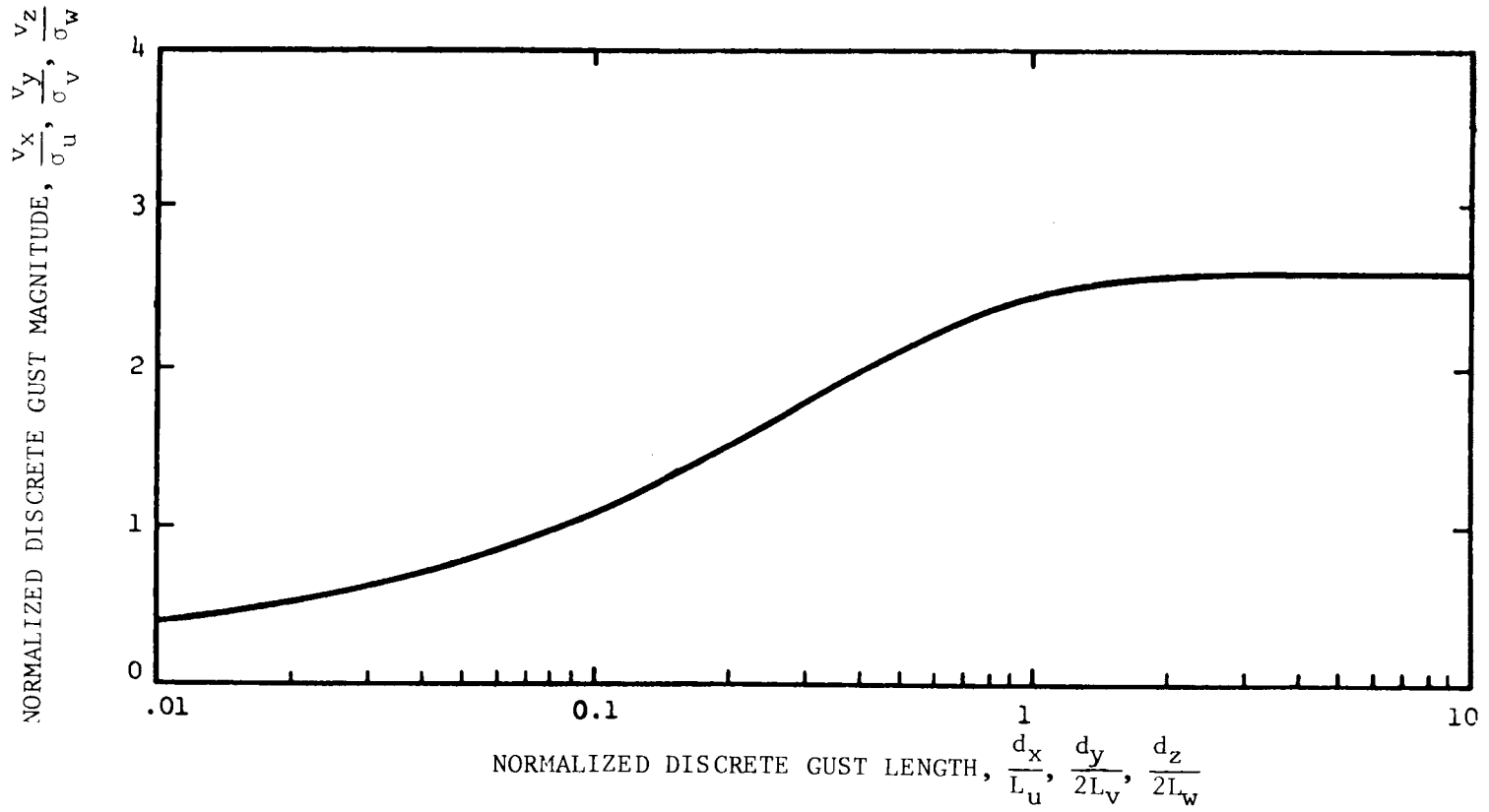

FIGURE 265. Magnitude of discrete gusts.

MIL-STD-1797A
APPENDIX A

3. Low-altitude disturbance model

This section specifies the model of atmospheric disturbances to be used for all Category C and other low-altitude operations. The effects of wind shear, turbulence and gusts may be analyzed separately. Some analysis and piloted simulation is required considering a complete environmental representation, demonstrating compliance with the requirements with the cumulative effects of wind shear, turbulence and gusts. A non-Gaussian turbulence representation together with a wind model may also be used to represent the patchy, intermittent nature of actual measured turbulence.

a. Wind speeds

The wind speed measured at 20 feet above the ground, u_{20} , is shown on figure 263 as a function of probability of occurrence. The values to be used for the different intensities of atmospheric disturbance are indicated.

b. Wind shear

The magnitude of the wind scalar shear is defined by the use of the following expression for the mean wind profile as a function of altitude:

$$u_w = u_{20} \frac{\ln(h/z_o)}{\ln(20/z_o)}$$

where $z_o = 0.15$ feet for Category C Flight Phase
= 2.0 feet for other Flight Phases.

c. Vector shear

Different orientations of the mean wind relative to the runway for Category C, or relative to the aircraft flight path for other Flight Phases, shall be considered. In addition, changes in direction of the mean wind speed over a given height change shall be considered as follows:

Disturbance intensity	Change in mean wind heading (degrees)	Height of vector shear (feet)
LIGHT	0	
MODERATE	90	600
SEVERE	90	300

A range of values for the initial wind orientation and the initial altitude for onset of the shear shall be considered. Relative to the runway, magnitudes of $u_{20} \sin \Psi_w$ greater than the crosswind values in 4.5.6 or tailwind components at 20 feet greater than 10 knots need not be considered. At any altitude other than 20 feet these limits do not apply.

d. Turbulence

The turbulence models of 1a or 1b above shall be used. The appropriate scale lengths are shown on figure 266 as functions of altitude. The turbulence intensities to be used are $\sigma_w = 0.1u_{20}$, and σ_u and σ_v given by figure 267 as functions of σ_w and altitude.

MIL-STD-1797A
APPENDIX A

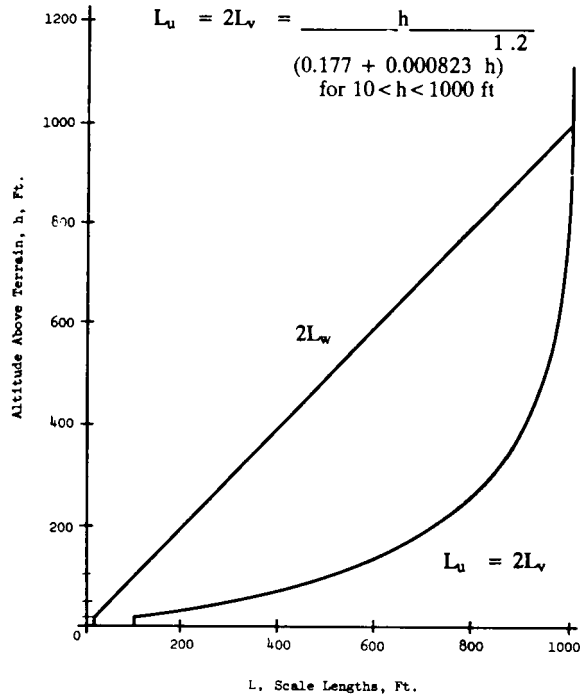

FIGURE 266. Low-altitude turbulence integral scales.

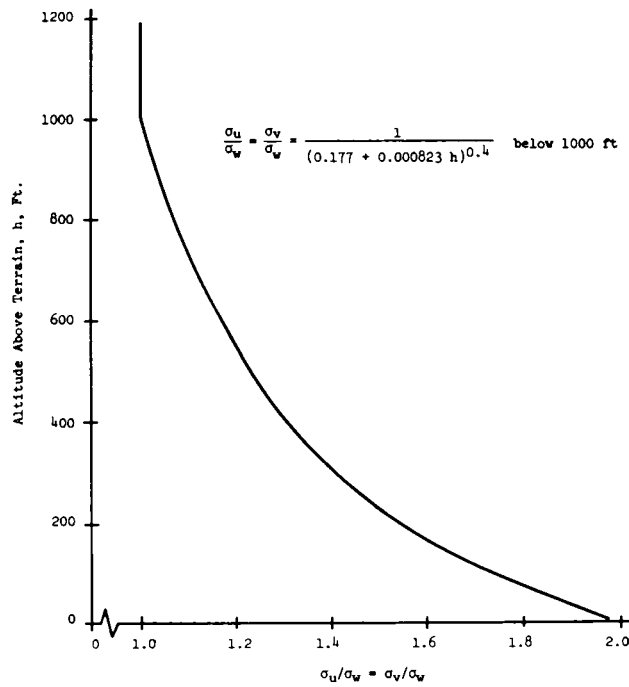

FIGURE 267. Horizontal turbulence RMS intensities.

MIL-STD-1797A
APPENDIX A

e. Gusts

Discrete gusts of the form specified in 2c above shall be used, with both single and double ramps to be considered. Several values of dm shall be used, each chosen so that the gust is tuned to each of the natural frequencies of the airplane and its flight control system. The gust magnitudes shall be determined from figure 265 using the appropriate values from figures 266 and 267. The two halves of a double gust do not have to be the same length or magnitude.

4. Carrier landing disturbance model

This section specifies the model of atmospheric disturbances to be used for carrier landing operations. This model shall be used in analysis and piloted simulation to determine aircraft control response and path control accuracy during carrier landing. This model supplements but does not replace the low-altitude disturbance model of part 3 above.

The terminal approach carrier disturbance model shall be used during simulation of the last 1/2 mile of the carrier approach. The u velocity component is aligned with the wind over deck. Total disturbance velocities are computed by adding segments caused by random free-air turbulence, u_1, v_1, w_1 ; steady ship-wake disturbance, u_2, w_2 ; periodic ship-motion-induced turbulence, u_3, w_3 ; and random ship-wake disturbance, u_4, v_4, w_4 . The total air disturbance components $u_g, v_g,$ and w_g are then computed as

$$u_g = u_1 + u_2 + u_3 + u_4$$

$$v_g = v_1 + v_4$$

$$w_g = w_1 + w_2 + w_3 + w_4$$

The input to all of the random disturbance filters shall be generated by filtering the wide-band, Gaussian output of zero-mean, unit-variance random-number generators.

a. Free-air turbulence components

The free-air turbulence components which are independent of aircraft relative position are represented by filtering the output of white-noise generators described in 4. above to produce the following spectra:

$$\phi_{u_1}(\Omega) = \frac{200}{1 + (100\Omega)^2} \quad (\text{ft/sec})^2 \text{ per rad/ft}$$

$$\phi_{v_1}(\Omega) = \frac{939 [1 + (400\Omega)^2]}{[1 + (100\Omega)^2][1 + (\frac{400}{3}\Omega)^2]} \quad (\text{ft/sec})^2 \text{ per rad/ft}$$

$$\phi_{w_1}(\Omega) = \frac{71.6}{1 + (100\Omega)^2} \quad (\text{ft/sec})^2 \text{ per rad/ft}$$

b. Steady component of carrier airwake

The steady components of the carrier airwake consist of a reduction in the steady wind and a predominant upwash aft of the ship which are functions of range. Figure 268 illustrates the steady wind functions u_2/V_{wd} and w_2/V_{wd} as functions of position aft of the ship center of pitch.

MIL-STD-1797A
APPENDIX A

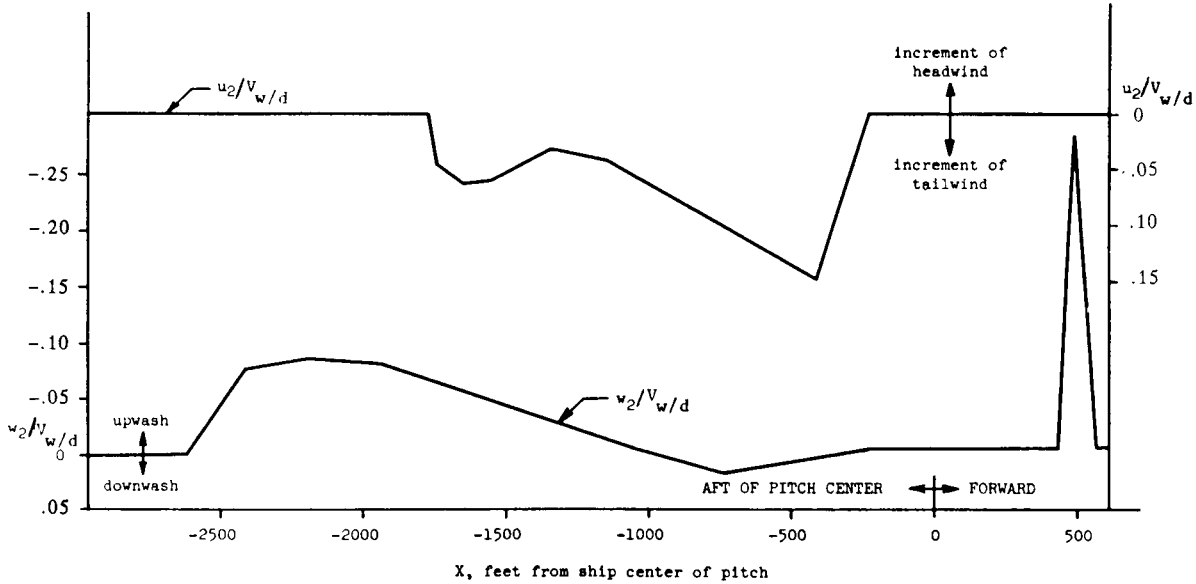

FIGURE 268. CVA ship burble steady wind ratios.

MIL-STD-1797A
APPENDIX A

c. Periodic component of carrier airwake

The periodic component of the airwake varies with ship pitching frequency, pitch magnitude, wind over deck and aircraft range. These components are computed as follows:

$$u_3 = \theta_s V_{w/d} (2.22 + 0.0009X)C$$

$$w_3 = \theta_s V_{w/d} (4.98 + 0.0018X)C$$

$$C = \cos \left\{ \omega_p \left[t \left(1 + \frac{V - V_{w/d}}{0.85V_{w/d}} \right) + \frac{X}{0.85V_{w/d}} \right] + P \right\}$$

where: ω_p = Ship pitch frequency, radians/second.

θ_s = Ship pitch amplitude, radians.

P = Random phase, radians.

The u component is set to zero for X < -2236 feet, and the w component is set to zero for X < -2536 feet.

d. Random component of carrier airwake

The ship-related random velocity components are computed by filtering the white noise as follows:

$$u_4 = \frac{\sigma(x)\sqrt{2\tau(X)} (\text{Input})}{\tau(X)j\omega + 1}$$

$$w_4 = v_4 = \frac{0.035V_{w/d}\sqrt{6.66}}{3.33j\omega + 1}$$

where: $\sigma(X)$ = RMS Amplitude-ft/sec. (figure 269)

$\tau(X)$ = Time constant-sec. (figure 269)

$$\text{Input} = \begin{bmatrix} \text{Random number} \\ \text{output} \end{bmatrix} \begin{bmatrix} j\omega \\ j\omega + 0.1 \end{bmatrix} \sin(10\pi t)$$

SELECTION OF THE MODEL:

The philosophy in selecting this model is based upon two fundamental precepts:

Keep the modeling form as simple as possible; and

use parameters that have direct relationships to aircraft dynamics or flying qualities.

MIL-STD-1797A
APPENDIX A

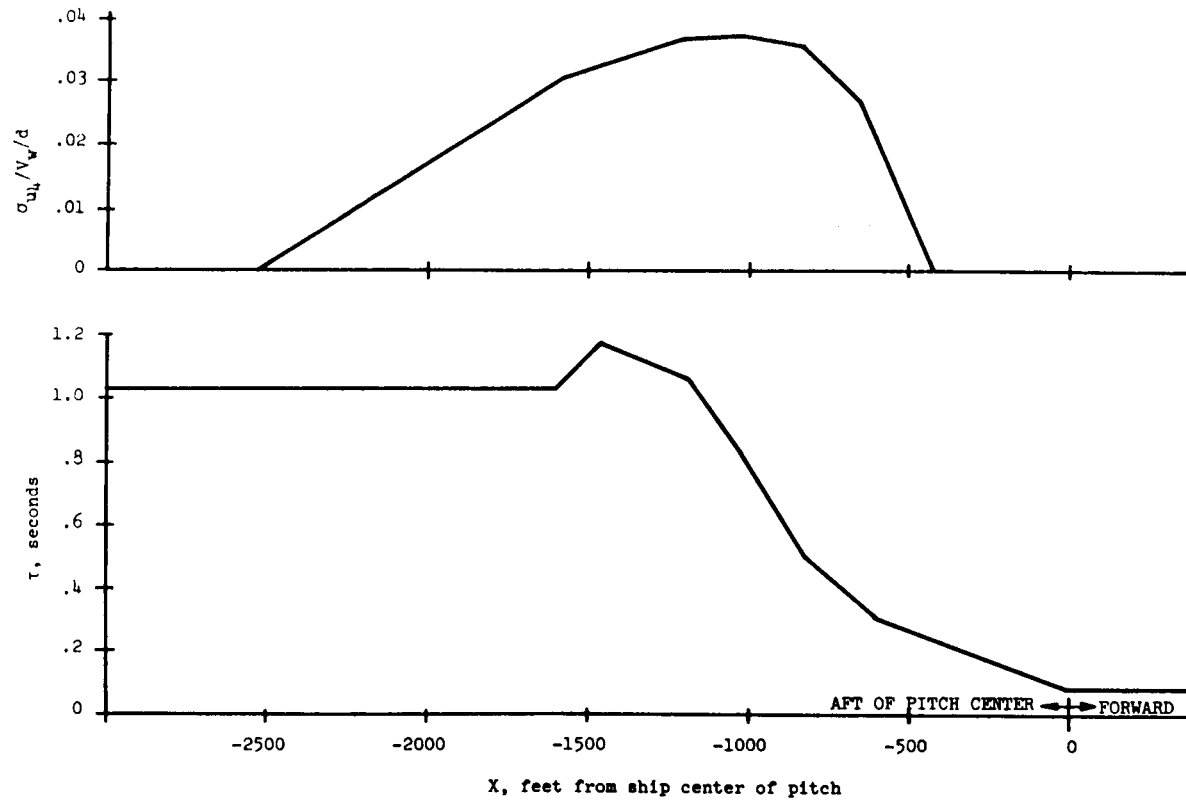

FIGURE 269. u-component burble time constant and variance.

MIL-STD-1797A
APPENDIX A

This requires a rational approach to the tradeoff between engineering convenience and physical correctness in disturbance models. The evaluation of the effects of atmospheric disturbances on aircraft flying qualities has been approached in diverse ways. The large volume of literature is evidence of this. It is far too easy to become bogged down in the ill-defined tradeoffs between Dryden and von Karman disturbance forms, the need for non-Gaussian or non-stationary characteristics, the debate over how and when to model wind shear effects, or whether shorter disturbance scale lengths are more realistic than longer ones. Aircraft designers and simulator researchers continually face such questions, and while they may find answers suitable for one situation, the same questions can and do reappear on subsequent occasions.

In order to keep the discussion in perspective, it is appropriate first to define what is meant by flying qualities. One accepted definition is, "those aircraft characteristics which govern the ease or precision with which the pilot can accomplish the mission." Further, flying qualities are often measured by subjective pilot opinion according to the Cooper-Harper rating scale which ties flying qualities assessment to the particular task. Due consideration of environmental conditions is, in turn, implied. An aircraft can have characteristics that make the task of landing relatively easy in calm air but very demanding in strong disturbances, even though the aircraft characteristics may not have changed.

For the purposes of the handling qualities Standard, an engineering model of atmospheric disturbances is required. This engineering model may be the simplest or minimum acceptable model that correctly identifies the primary parameters of particular interest. This is in contrast to the objectives of basic research into meteorological phenomena or the physics of atmospheric dynamics. Using an available more elaborate model, of course, is also acceptable and may be necessary to assess the effects of structural modes or saturation of the flight control system.

The approach taken herein is to define basic utility models that can be applied to most handling quality evaluations. For some applications the procuring activity may want to designate a specialized model. For example, if a high-fidelity model is required to reproduce the effects of structural modes (generally at frequencies higher than those for piloted control), the von Karman model would be appropriate. Alternative disturbance models are surveyed later in this discussion.

It is a recognized fact that the large-amplitude, low-frequency component of the disturbance model plays a dominant role in separating good and bad handling qualities. The problem with a random disturbance model is that the large wind shears occur at the critical point on only a few runs, resulting in discrepancies in pilot ratings and comments. A discrete wind shear is defined for the low-altitude model to insure that all pilots will experience the critical input.

The wind vector shear model has constant gradients of wind magnitude and allows for constant or changing direction. A great number of combinations of wind shear can be derived from such a model. However, only four limiting cases are recommended for verification of flying qualities: decreasing headwind, tailwind, sidewind shears, and a constant-magnitude shear with changing azimuth.

Atmospheric disturbance features

In general, variations in properties can be viewed in terms of their engineering convenience versus their physical correctness. For example, the well-known von Karman turbulence form yields more correct spectral characteristics, but it is not so easily realized computationally as the more approximate Dryden form, and does not lend itself quite so well to statistical analysis. Nevertheless, where another subject which requires more rigor uses the same atmospheric model as in the flying qualities simulation-structural analysis may require the von Karman form—the more rigorous form can of course be used for flying qualities too. The same kind of tradeoff between convenience and correctness is a dominant theme in several other respects, as we shall discuss below.

MIL-STD-1797A
APPENDIX A

a. Determinism versus randomness

Atmospheric disturbance models can be separated according to their degree of determinism or randomness. Characteristics such as mean wind and wind shear are normally handled on a deterministic basis, or as a set of deterministic cases presented in random order. Turbulence is usually modeled as a randomly occurring phenomenon, or as a time history with known statistical properties, started at a random time. Wind velocity or wind shear can be described in strictly probabilistic terms; and turbulence, conversely, can be described in wholly deterministic terms (as composed of summed sinusoidal gusts). In addition, random and deterministic models are often combined to suit the needs of a particular application. Deterministic features are usually quantified directly using analytical functions or tables (e.g., mean wind speed and direction or wind shear gradients with respect to time or space). Random components, on the other hand, invoke random-variable sources having their own particular statistical properties of probability distribution and correlation. Appropriate partitioning of model determinism versus randomness figures greatly in the success of any given application, as we shall discuss shortly.

b. Probability distribution

The probability distribution of gusts describes the frequency of occurrence of different amplitudes in terms of probability density, cumulative probability distribution, or a number of central moments (mean, variance, skewness, kurtosis, etc.). While the Gaussian distribution is mathematically convenient, several turbulence models having more realistic non-Gaussian distributions have been developed in order to address the characteristics of patchiness¹⁵ and intermittency¹⁶. But the usefulness of these model features depends in part upon whether the specific application can accommodate a characteristic such as patchiness on a probabilistic basis. If the scenario involves a limited time frame and a limited number of sample runs (as in a manned simulation), then a more deterministic treatment of patchiness might be required. For example, Delft Univ. of Tech., Dept of Aerospace Engrg Memo M-304 describes a direct modulation of turbulence intensity to obtain a patchy gust field. This, in turn, could permit the return to the more convenient Gaussian distribution for random gust components without undue sacrifice in correctness.

c. Correlation

Correlation is the measure of the predictability of a gust component at some future time or point in space, based on the knowledge of a current gust. Since the modeling of a random process such as turbulence consists of developing techniques for emulating the behavior of that process in time, it can be seen that correct duplication of the correlation can be important. There are at least two ways of presenting correlation information, in the time or space domain (correlation functions) or in the frequency domain (spectral density functions).

The correlation function can be converted to the frequency domain via a Fourier transformation, resulting in the power spectral density function. A frequency-domain representation is often useful because it permits comparison of the aircraft's spectral features with the spectral content of the disturbance. It is thereby possible to judge the degree to which the turbulence will affect the aircraft's motion, as described in AIAA Paper 77-1145. A time- or spatial-domain correlation function can be useful when generating gusts from multiple point sources (Stanford Univ. SUDAAR No. 489).

¹⁵ Patchiness is frequently considered as corresponding to a proportionately higher rate of occurrence of very large-magnitude gusts than found in a Gaussian distribution, and is reflected by the higher-order even central moments (4th, 6th, etc.) (NASA-CR-2451).

¹⁶ Intermittency is counterpart to patchiness when applied to gust velocity differences over a given time or space interval (Delft Univ. of Techn., Dept of Aerospace Engrg Memo M-304).

MIL-STD-1797A
APPENDIX A

The two most common ways of describing gust correlation are the Dryden and von Karman power spectral density forms. As mentioned earlier, the significant aspect of a choice between the two lies in the engineering convenience versus the physical correctness. However, the correctness advantage of the von Karman form is not an issue unless the significant spectral content is centered in the microscale range about one decade or more above the integral scale break frequency.

d. Dimensionality of gust field

A gust field can be described using various orders of dimensionality. The simplest is a one-dimensional-field model that involves just the three orthogonal velocity components taken at a single point (usually the aircraft center of gravity). The Taylor hypothesis¹⁷ (frozen field) can be applied, however, in order to approximate gust gradients with respect to the x-axis of the aircraft without increasing dimensionality. A two-dimensional field model used to define a gust field in the aircraft x-y plane can be modified for the size of the aircraft relative to gust scales. (A large aircraft relative to the gust scale attenuates gust gradient spectral power at high frequencies.) A two-dimensional field can lead to greatly increased mathematical complexity over that of a one-dimensional field (AGARD Rpt 372) but some turbulence models simply define one-dimensional uniform velocity components and then add two-dimensional forms for gust gradients that contain aircraft size effects (Stanford Univ. SUDAAR No. 489). A third dimension can be introduced in the form of an altitude-dependent wind shear (e.g., FAA-RD-79-84 and NASA-CR-152064).

e. Stationarity

A random gust is stationary if, for a collection of gust samples, the corresponding probability and correlation properties describe any additional gust sample that may be taken. Thus stationarity implies an atmospheric disturbance having an invariant mean, variance, and correlation length (or time) along the flight path. There is no restriction on whether the probability distribution is Gaussian or not.

An alternative means of introducing patchiness or intermittency is to create a nonstationary turbulence field through direct modulation of intensity (AIAA Paper 80-0763). Thus the basic noise source can remain Gaussian.

Practical implementation considerations

The application of atmospheric disturbance models can involve a number of practical implementation problems—many associated with digital computer programming. One role of this Handbook is to assist in answering some of the common implementation questions and to point out pitfalls frequently encountered. Some examples include:

Digital implementation of continuous spectral forms.

Correct scaling of random noise sources.

Evaluation of need for gradient components.

Implementation of gust gradients, gust time derivatives, and gust transport lags.

Table LV illustrates some of the practical implementation matters.

¹⁷ The Taylor hypothesis (J. Atmos. Sciences, Vol 20) assumes a gust field frozen in space such that time and space dependencies along the relative wind are directly related by the airspeed.

MIL-STD-1797A
APPENDIX A

TABLE LV. Examples of practical implemental matters.

Implementation Item	Handbook Method	Comments
<p>Digital implementation of continuous filter forms. Example: first-order Dryden form (applicable u_g or p_g)</p>	<p>Spectral form:</p> $\phi_{uu} = \sigma_{u_g}^2 \frac{2L}{w} \frac{1}{1 + (L_u \Omega)^2}$ <p>Discrete realization: Where $u_g = C_1 u_g + C_2 n$</p> $C_1 = \begin{cases} \text{either } \exp(-aT) & (z - \text{transform}) \\ \text{or } 1 - at & (\text{Euler integration}) \\ \text{or } \frac{2 - aT}{2 + aT} & (\text{Tustin transform}) \end{cases}$ $a = \frac{v}{L_u}$ <p>and $C_2 = \sqrt{1 - C_1^2} \begin{pmatrix} \sigma_{u_g} \\ \sigma_{\eta} \end{pmatrix}$</p> <p>where n is a normally distributed random number with variance σ_{η}^2</p>	<p>This matter can be particularly confusing because spectral forms are written in a number of ways—one-sided or two-sided, in terms of spatial or temporal frequency, or in terms of angular or cyclical frequency. Furthermore white noise in the continuous domain must be converted to random numbers in the discrete domain.</p>
<p>Determination of p-gust importance</p>	<p>Criterion: p-gust is significant relative to v-gust if:</p> $\sqrt{\frac{b}{L}} \cdot C_{g_p} > C_{\ell_\beta} $ <p>or</p> $\frac{2}{\sqrt{L_w b}} L_p > L_v $ <p>where b is span and L_w is gust scale length</p>	<p>p-gust can be an important disturbance component in the roll axis, especially if effective dihedral is small.</p>
<p>Determination of p-gust intensity</p>	<p>Holley-Bryson model:</p> $\sigma_{p_g} = \frac{2.15 \sigma_w}{\sqrt{\frac{bL}{w} \left(1 + \frac{b}{L_w}\right)}}$ <p>MIL-F-8785C:</p> $\sigma_{p_g} = \frac{0.95}{\sqrt{3b^2 L_w}}$ <p>An approximate intensity averaged over several models:</p> $\sigma_{p_g} = \frac{1.9}{\sqrt{bL_w}} \sigma_{w_g}$	<p>If the p-gust component is considered important, one must determine the intensity in order to implement the filter. A specific, easy-to-compute value for intensity is seldom readily available. Also, the various p-gust model forms all have different ways of expressing model parameters.</p>
<p>Realization of von Karman-like spectra</p>	<p>Boeing higher order linear filter forms:</p> $u_g: \frac{\left(s + 4 \frac{V}{L}\right)}{\left(s + 0.84 \frac{V}{L}\right) \left(s + 6 \frac{V}{L}\right)}$ $v_g, w_g: \frac{\left(s + 0.38 \frac{V}{L}\right) \left(s + 7.7 \frac{V}{L}\right)}{\left(s + 0.48 \frac{V}{L}\right) \left(s + 1.22 \frac{V}{L}\right) \left(s + 11.1 \frac{V}{L}\right)}$ <p>STI reduced order variation based on Boeing forms:</p> $v_g, w_g: \frac{\left(s + 8 \frac{V}{L}\right)}{\left(s + 1.7 \frac{V}{L}\right) \left(s + 12 \frac{V}{L}\right)}$	<p>An approximation to the increased correlation in the microscale range of the von Karman spectral form can be realized with second- and third-order linear filters. Digital implementation would involve finite difference equations of corresponding order. Correct spectral content above 100 (V/L) rad/sec would require matching von Karman spectra with even higher order filters.</p>

MIL-STD-1797A
APPENDIX A

A survey of existing models

The objects in surveying atmospheric disturbance models are to examine how various models make the tradeoff between convenience and correctness and to search for strengths or deficiencies that could be important to a flying qualities investigator.

Table LVI lists some of the models, out of those surveyed, that offer some potential in flying qualities applications. For each table entry a few summary remarks are given along with a list of basic references.

SUBSTANTIATION

As we gain more experience with handling qualities evaluations via piloted simulation, it has become apparent that only a few key features are important for our purpose, to separate good and bad handling qualities. In fact, the complexity that is required to emulate real-world atmospheric disturbances often clouds the issue. For example, such items as boundary layer effects, patchiness, correlation of turbulence with steady wind velocity and terrain, and detailed wind shear characteristics associated with frontal activity can consume an inordinate amount of effort. To alleviate this problem we recommend using the simplified Dryden disturbance model whenever other considerations permit. This model retains all the essential features found to be useful in many piloted simulator handling quality investigations using complex disturbance models. The Dryden form has been chosen because it is simple to mechanize, as opposed to the von Karman form that must be approximated to become realizable.

REQUIREMENT LESSONS LEARNED

Experience has shown that aircraft with severe handling quality deficiencies can receive Level 1 pilot ratings in calm air. Addition of atmospheric disturbances to the problem forces the pilot to use aggressive control activity that tends to expose handling qualities deficiencies. Addition of discrete gusts, scalar and vector shear forces the pilot to act, rather than waiting out the zero-mean turbulence. One problem with using a random disturbances model is that the large low-frequency gusts (wind shears) occur in an unpredictable fashion. In the FAA-RD-75-123 experiment one evaluation pilot received several large shears just prior to touchdown and rated the configuration a 7. Two other pilots only saw the large inputs several miles from touchdown and rated the same configuration between 3 and 4-1/2. The discrete shear model is included to resolve this problem.

A random noise source (white noise) is required to mechanize the equations in table LIV. This source should be checked to insure adequate power at low frequencies. Experience with some simulations has shown that the noise source was deficient at low frequency. As mentioned above, it is the low-frequency component of the atmospheric disturbance that is important for handling qualities investigations.

Finally, when using the more complex models it seems nearly impossible to formulate a program without an error involving a factor of 2 or π . The lesson here is to measure the statistics of the output of the disturbance model before starting piloted evaluations.

MIL-STD-1797A
APPENDIX A

TABLE LVI. A Survey of atmospheric disturbance models.

Model	Key Features	Reference Documents
Dryden turbulence	A convenient spectral form based on an exponential autocorrelation function for the axial component.	"A Review of the Statistical Theory of Turbulence"
von Karman turbulence	A spectral form for which the auto-correlation function includes a finite microscale, thus the relative proportion of spectral power at high frequencies exceeds that of the Dryden.	"Atmospheric Turbulence," "Progress in the Statistical Theory of Turbulence," and NASA TR-R-199/
Ornstein-Uhlenbeck turbulence	A spectral form with first-order longitudinal and transverse components.	AIAA Paper 80-0703
Etkin one-dimensional turbulence power spectra	The local turbulent velocity field is approximated by a truncated Taylor series which yields uniform and gradient components. High frequency spectral components eliminated on the basis of aircraft size. Based on Dryden form but gradient spectra are non-realizable unless simplified.	"Dynamics of Flight," AGARD Rpt 372, and "A Theory of the Response of Airplanes to Random Atmospheric Turbulence"
Versine gust	A discrete gust waveform.	MIL-F-8785C
Lappe low-altitude turbulence model	Experimentally-obtained data of vertical gust spectra, mean wind speed, and lapse rate were used to develop a low-level turbulence model. The turbulence spectra are presented for different types of terrain, height, and meteorological conditions.	"Low-Altitude Turbulence model for Estimating Gust Loads on Aircraft"
Multiple-point-source turbulence	A two-dimensional gust field generated from two or more noise sources having prescribed correlation functions and located spanwise or lengthwise on the vehicle.	Stanford Univ SUDAAR No. 489, AIAA Paper 80-1836, and AFFDL-TR-68-85
Holley-Bryson random turbulence shaping filters	A matrix differential equation formulation of uniform and gradient components including aircraft size effects. Filter equation coefficients determined from least square fit to multi-point-source-derived correlation functions.	Stanford Univ SUDAAR No. 489
University of Washington non-Gaussian atmospheric turbulence model	Non-Gaussian model using modified Bessel functions to simulate the patchy characteristic of real-world turbulence. Spectral properties are Dryden and include gust gradients.	NASA-CR-2451 and AFFDL-TR-69-67

MIL-STD-1797A
APPENDIX A

TABLE LVI. A Survey of atmospheric disturbance models - Continued.

Model	Key Features	Reference Documents
Delft University of Technology non-Gaussian structure of the simulated turbulent environment	Non-Gaussian model similar in form to the University of Washington model but uses the Hilbert transform to model intermittency as well as patchiness. Include University of Washington model features extended to approximate transverse turbulence velocities and gradients.	Delft Univ of Tech Memo M-304
Royal Aeronautical Establishment model of non-Gaussian turbulence`	Non-Gaussian turbulence model with a variable probability distribution function and a novel digital filtering technique to simulate intermittency. Spectral form approximately von Karman.	Royal Aircraft Establishment, Tech Memo FS46; NASA-CR-152194; and "Modeling of Gusts and Wind Shear for Aircraft Assessment and Certification
The Netherlands National Aerospace Laboratory model of non-Gaussian turbulence	Similar to the Royal Aeronautical Establishment model but extended to include patchiness and gust gradient components and transverse velocities.	NLR Memo VS-77-024 and NLR MemoVS-77-025
University of Virginia turbulence model	Models patchiness by randomizing gust variance and integral scale length of basic Dryden turbulence.	"Investigation of the Influence of Simulated Turbulence on Handling Qualities"
Indian Institute of Science nonstationary turbulence model	Nonstationary turbulence is obtained over finite time-windows by modulating a Gaussian process with either a deterministic or random process. The result is patch-like turbulence similar to the University of Washington model--except the time-varying statistics of the turbulence are presented for the deterministic modulating functions.	AIAA Paper 80-0703
FAA wind shear models	Three-dimensional wind profiles for several weather system types including fronts, thunderstorms, and boundary layer. The profiles are available in table form.	FAA-RD-79-84 and FAA-RD-77-36
STI wind shear model	Time and space domain models of mean wind and wind shear--ramp wave forms--are combined with MIL-F-8785C Dryden turbulence to obtain the total atmospheric disturbance. The magnitudes of the mean wind and wind shear and evaluated in terms of the aircraft's acceleration capabilities.	NASA-CR-152064 AGARD CP-249

MIL-STD-1797A
APPENDIX A

TABLE LVI. A Survey of atmospheric disturbance models - Continued.

Model	Key Features	Reference Documents
Sinclair frontal-surface wind shear model	A generic model of frontal-surface wind shear derived from a reduced-order form of Navier-Stokes equations. Relatively simple to use and can match the overall characteristics of measured wind shears.	FAA-RD-79-59 and AGARD-CP-249
MIL-F-8785B atmospheric disturbance model	Intensities and scale lengths are functions of altitude and use either Dryden or von Karman spectral forms or a versine discrete gust. Also, spectral descriptions of rotary gusts.	AFFDL-TR-69-72
MIL-F-8785C atmospheric disturbance model	Same as MIL-F-8785B with the addition of a logarithmic planetary boundary layer wind, a vector shear, and a Nave carrier airwake model.	MIL-F-8785C
ESDU atmospheric turbulence	Rather general but contains comprehensive descriptive data for turbulence intensity, spectra, and probability density.	ESDU Item No. 74031 and ESDU Item No. 75001
Boeing atmospheric disturbance model	A comprehensive model of atmospheric disturbances that includes mean wind, wind shear, and random turbulence. Turbulence is Gaussian and uses filters that closely approximate the von Karman spectral form. Mean wind and turbulence intensity are functions of meteorological parameters.	NASA-CP-2028/FAA-RD-77-173 and FAA-RD-74-206
Wasicko carrier airwake model	Includes mean wind profile, effect of ship motion, and turbulence.	Systems Tech Inc Rpt No. 137-2
Nave ship airwake model	Includes free-air turbulence filters plus steady, periodic, and random components of airwake which are functions of time and space.	NADC-78172-60
Vought airwake model for DD-963 class ships	Combined random and deterministic wind components for free-air and ship airwake regions. Based on wind-tunnel flow measurements.	Vought Corp Rpt No. 2-55800/8R-3500
STI wake vortex encounter model	A two-dimensional model of the flow field due to the wake vortex of an aircraft is presented. The parameters of the flow-field model are weight, size, and speed of the vortex-generating aircraft, and distance and orientation of the vortex-encountering aircraft. Strip theory is used to model the aerodynamics of the vortex-encountering aircraft.	"A Theory of the Resonance of Airplanes to Random Atmospheric Turbulence"

MIL-STD-1797A
APPENDIX A

5.9.2 Definition of atmospheric disturbance model form - verification.

Verification shall be by analysis and simulation.

VERIFICATION RATIONALE (5.9.2)

The use of wind shear in handling quality evaluations is primarily to provide a disturbance that forces aggressive closed-loop pilot behavior. It is felt to be unnecessary to simulate vertical shears since the horizontal shear disturbs the aircraft both in airspeed and flight path. For specialized applications, such as the carrier landing burble or checking a downburst incident, a vertical shear should be included.

For most cases, application of this requirement is straightforward. However, for some cases a more complex special-purpose model may be required-as for the examples cited above.

AFFTC has had some success in backing out the turbulence from flight data.

VERIFICATION GUIDANCE

This guidance on choice of an atmospheric disturbance model is taken from AIAA Paper 81-0302.

Atmospheric modeling needs vary greatly with the specific application--even for a single given aircraft and flight condition. Some analysis procedures require only a simple one-dimensional turbulence model (e.g., Dryden) and a single gust component. At the other extreme, elaborate simulations can involve a fully defined two-dimensional, nonstationary turbulence field along with a spatially- or time-varying mean wind field (i.e., wind shear).

Some ways of viewing the modeling needs of a user include:

How disturbance components enter the airframe force and moment equations.

Inner/outer loop structure hierarchy for mission/aircraft centered features.

The need for determinism versus randomness in the flying qualities application.

Consider briefly how each of these could be approached.

Table LVII illustrates how various atmospheric disturbance components might enter a set of linearized force and moment equations. Based on our knowledge of the various stability derivatives and respective gust component intensities, we can estimate the relative effect of various gust terms in order to judge:

Axis cross-coupling (e.g., longitudinal and lateral-directional forces and moments are likely to be fairly well decoupled).

Translational motion (e.g., force equations are mainly affected by gust velocity components alone).

Rotational motion (e.g., moment equations are affected by gust velocity, time derivative, and gradient components).

Some of the gust gradients affect only some components of the aircraft, giving values different from the corresponding rotary derivatives. The gradient $\partial V_g/\partial x$ affects the body and tail but, unlike r , not an unswept wing; $\partial w/\partial y$ affects the wing but, unlike p , not the vertical tail.

MIL-STD-1797A
APPENDIX A

TABLE LVII. Linearized gust derivative terms in airframe dynamics.

Term Equation	(-q _g)						(-r _{1g})		(-r _{2g})		(p _g)	
	u _g	w _g	ū _g	ŵ _g	$\frac{\partial u_g}{\partial x}$	$\frac{\partial w_g}{\partial x}$	v _g	ṽ _g	$\frac{\partial u_g}{\partial y}$	$\frac{\partial v_g}{\partial x}$	$\frac{\partial v_g}{\partial y}$	$\frac{\partial w_g}{\partial y}$
ΣX	-X _w						-X _v					
	-X _u											
ΣZ		-Z _w				Z _{q'^{small}}						
		-Z _u		-Z _{w'^{small}}			-Z _{v'^{small}}					
ΣM		-M _w		-M _q		M _q						
		-M _u					-M _v					
ΣY												
							-Y _v					
								-Y _{v'^{small}}		-Y _{r'^{small}}		
ΣL												
							-L _v					-L _p
ΣN												
							-N _v	-N _{v̇}		-N _r		-N _p

The loop structure hierarchy in mission/aircraft-centered features provides us with another way of judging atmospheric disturbance model needs. Figure 270 shows a spectral comparison of mission/aircraft-centered features against atmospheric disturbance features. Although the spectral boundaries of each feature are admittedly more ill-defined than shown, we can nevertheless illustrate a point. That is, any mission/aircraft features that are to be analyzed require the significant atmospheric disturbance features acting within the same spectral range. Conversely, atmospheric disturbance features much outside that spectral range are superfluous. Taking the argument to the extreme, navigation considerations are not likely to involve the microscales¹⁸ or even integral¹⁹ scale range of turbulence. Likewise, short-term stability augmentation system or flexibility effects would not require inclusion of mean wind or wind shear features.

¹⁸ The microscale of turbulence is an indication of the distance or time separation over which gusts remain highly correlated, i.e., the inertial subrange (The Structure of Atmospheric Turbulence). Von Karman turbulence involves a non-zero microscale; Dryden's is zero.

¹⁹ The integral scale of turbulence is equal to the area under the normalized autocorrelation function and much larger than the microscale. Correct measurement of the integral scale depends upon stationarity ("Atmospheric Turbulence").

MIL-STD-1797A
APPENDIX A

Continuing in a similar vein, the results obtained from exciting an aircraft by atmospheric disturbances depend greatly upon how the aircraft is being operated, i.e., what the pilot is doing. The gust response can vary dramatically between hands-off operation and tight pilot regulation of attitude and flight path.

Frequently the effects of wind shear have been evaluated by measurement of the flight path excursion for a controls-fixed penetration of the shear. The phugoid is, of course, the dominant response mode in this case, and the result is generally a large-amplitude, nearly undamped, roller-coaster-like flight path oscillation. But pilots do not characteristically operate hands-off in a windshear environment. Rather, aircraft attitude is likely to be very well regulated by the pilot, hence the flight path and airspeed modes would be exponentially decaying according to heave and speed damping stability derivatives (Z_w and X_u , respectively, FAA-RD-78-7). These different assumptions lead to vastly different conclusions regarding performance and identification of critical flying qualities parameters.

MIL-STD-1797A
APPENDIX A

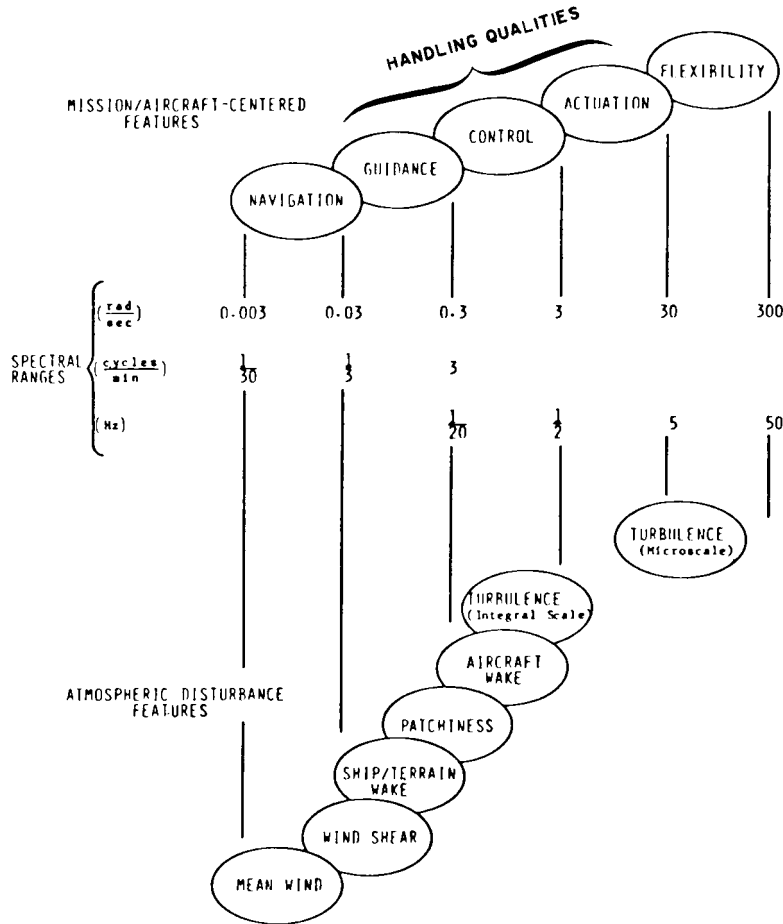

FIGURE 270. Comparative approximate frequency regimes of mission/aircraft-centered and atmospheric disturbance features.

We need also to consider how determinism and randomness affect our choice of atmospheric disturbance models. Strict reliance upon a wholly random gust model for a small-sample, short-term task evaluation is both impractical and improper. As investigators and evaluators, we desire to control disturbances well enough so that critical conditions and events can be staged. especially in the case of manned simulation This demands a fair degree of model determinism. On the other hand, pilot surprise and sensitivity to variation on call for a degree of randomness. Therefore a compromise must be reached. This blending deserves to be addressed in a systematic way. but sometimes solutions must be based upon experience more than clear rationale.

VERIFICATION LESSONS LEARNED

MIL-STD-1797A
APPENDIX A

4.9.3 Application of disturbance models in analyses.

The gust and turbulence velocities shall be applied to the aircraft equations of motion through the aerodynamic terms only, and the direct effect on the aerodynamic sensors shall be included when such sensors are part of the aircraft augmentation system. Application of the disturbance model depends on the motion variables and the range of frequencies of concern in the analysis. When structural modes are within or close to this range, the exact distribution of turbulence velocities must be considered. For this purpose, it is acceptable to consider u_g and v_g as being one-dimensional for the evaluation of aerodynamic forces and moments. The w_g should be considered two-dimensional, a function of both x and y .

When structural modes are not significant to the analysis or simulation, airframe rigid-body responses may be evaluated by considering uniform gust or turbulence immersion along with linear gradients of the disturbance velocities. The uniform immersion is accounted for by u_g , v_g , and w_g defined at the aircraft center of gravity. The angular velocities due to turbulence are equivalent in effect to aircraft angular velocities. Approximations for these angular velocities are defined (precise only at very low frequencies) as follows:

$$- \dot{\alpha}_g = q_g = \frac{\partial w_g}{\partial x}, p_g = \frac{\partial w_g}{\partial y}, r_g = \frac{\partial v_g}{\partial x}$$

For altitudes below 1750 ft, the turbulence velocity components u_g , v_g , and w_g are to be taken along axes corresponding to u_g aligned along the horizontal relative mean wind vector and w_g vertical.

REQUIREMENT RATIONALE (4.9.3)

The related MIL-F-8785C requirement is paragraph 3.7.5.

This requirement is included to insure proper implementation of the disturbance model.

REQUIREMENT GUIDANCE

This requirement is included simply as a reminder of a few key points; it is not intended to be a comprehensive guide. See 5.9.2 Guidance. It is believed that the level of competence of the majority of users is such that further guidance is not necessary.

REQUIREMENT LESSONS LEARNED

5.9.3 Application of disturbance models in analyses-verification.

Verification shall be by analysis and simulation.

VERIFICATION RATIONALE (5.9.3)

The requirement itself provides verification rationale.

VERIFICATION GUIDANCE

The requirement itself provides verification guidance.

VERIFICATION LESSONS LEARNED

DETERMINING EQUIVALENT SYSTEMS

Many flight control mechanizations are complex, and their mathematical models are of high order. All the requirements for modal parameters require matching the high-order response with a low-order equivalent. The modal requirements then apply for all realizable input magnitudes at all operating points within the appropriate flight envelope. There are many procedures in the literature for extracting reduced-order realizations of dynamic models. These methods have high-order dynamic models as their input, and low-order equivalent models as their output. For uniformity this appendix defines the essential components of such a procedure. However, the particular method used is left to the choice of the individual contractor and the procuring activity. Methods which have been used by various investigators include:

Matching frequency responses of high-order, linearized transfer functions

Matching frequency responses extracted from flight time histories using a fast Fourier algorithm

Matching frequency responses generated by stick cycling in flight

Using a maximum likelihood technique to match flight time history data

The method shall adjust all the parameters in the equivalent system, with the exception of certain numerator parameters in single-response matching. This exception shall apply only if approved by the procuring activity. The method shall produce the minimum possible value of the weighted sum of the squares of the frequency response differences in magnitude and phase angle between the equivalent low-order system (LOS) and the input high-order system (HOS) at n discrete frequencies, i.e.:

$$\frac{20}{n} \sum_{\omega_1}^{\omega_n} \left[(\text{gain}_{\text{HOS}} - \text{gain}_{\text{LOS}})^2 + 0.02(\text{phase}_{\text{HOS}} - \text{phase}_{\text{LOS}})^2 \right]$$

where

gain is in dB

phase is in degrees

ω denotes the input frequency

n is the number of discrete frequencies

When analytical data are used, the frequencies (at least ten per decade) shall be equi-spaced on the log scale. When experimental data are used, the low-order system shall be matched as closely as possible to the data at the experimental frequencies. The frequency range of the matching - and the frequency content of the input - shall be sufficient for an accurate determination of all the specified parameters of the equivalent low-order system.

The weighting between gain and phase is such that 1 dB of gain mismatch and 7 degrees of phase mismatch have equal significance in the total mismatch function. In practice the results have been found to be very insensitive to this weighting. For example, a value of 0.01745 (which appears to be a degrees-to-radians correction factor but actually is not) has been reported in the literature. This will not produce materially different results than will 0.02. Experience with one matching program is reproduced in the following excerpt from a McDonnell paper in Journal R.Ae.S., February 1976:

MIL-STD-1797A
APPENDIX B

The nominal value of W [weighting] in the cost function was 0.01745. Some runs were made with $W = (0.01745)^2$, so that equal weight could be assigned to gain (dB) and phase (radians) mismatches. This produced matches which were qualitatively judged to weight gain too heavily, and using 0.01745 instead produced matches which were a good balance between gain and phase for Neal and Smith's configurations. In fact, the parameter values were fairly insensitive to weighting coefficient choice, as indicated in the following table, which illustrates the effects of W changes for configuration 2-H.

W	τ	ω_{sp}	ζ_{sp}	L_α	K_q
$(0.01745)^2$	0.092	3.89	0.50	4.67	3.37
0.01745	0.095	3.95	0.51	4.67	3.44
0.05	0.104	3.75	0.54	3.71	3.88
0.1	0.110	3.70	0.56	3.34	4.13

The factor $20/n$ does not affect the equivalent parameters. It is included as a convenience to allow the mismatch function value to be compared with similarly defined mismatches in the literature.

When different responses are matched simultaneously (for example, roll rate to stick force and sideslip to rudder), each response shall have equal significance (magnitude difference in decibels). However, note that the minimum value of the total mismatch function will usually occur with numerically unequal gain and phase mismatches and unequal mismatches for different responses.

Modal parameters common to two responses shall be constrained to be identical. For example, the dutch roll mode shall have the same damping and frequency in the roll and sideslip responses. This requirement may be waived by the procuring activity if necessary for vehicles with flight control systems which utilize more than the conventional number of independent force and moment producers.

In the discussion of equivalent systems in 4.2.1.2 Guidance, mismatch envelopes are shown as a guide to determining whether a mismatch is allowable. The envelopes are defined as functions of the Laplace variable, s, as follows:

Upper Gain Envelope:

$$\frac{3.16s^2 + 31.61s + 22.79}{s^2 + 27.14s + 1.84}$$

Lower Gain Envelope:

$$\frac{0.095s^2 + 9.92s + 2.15}{s^2 + 11.6s + 4.95}$$

Upper Phase Envelope:

$$\frac{68.89s^2 + 1100.12s - 275.22}{s^2 + 39.94s + 9.99} e^{0.006s}$$

Lower Phase Envelope:

$$\frac{475.32s^2 + 184100.12s - 29460}{s^2 + 11.66s + 0.039} e^{-0.0072s}$$

MIL-STD-1797A
APPENDIX B

These envelopes are to be used only after the matching process has been performed. Normally, mismatches will be far smaller than those the envelopes allow.

Components of computer program

The basic components of an equivalent systems computer program which is currently used by the U.S. Government are shown in the following simplified flow chart (figure 271). The broken lines enclose three separate subroutines which are briefly described below.

Input -- The Input section establishes the high-order response and the initial guesses for its low-order system. It accounts for elements that are held constant (e.g., the short-period pitch numerator root, $1/T_{\theta_2}$). If two systems are matched simultaneously, the objective vector would consist of two frequency responses and the search vector of two sets of transfer function coefficients. In addition the Input section also sets the frequency range, number of frequencies, and number of iterations.

Search -- The Search section manipulates the search vector to make its frequency response approximate the objective vector. It is made up of four subsections: a search algorithm containing a minimization strategy, a cost function, a frequency response calculator, and a set of convergence criteria. The search algorithm is a general-purpose, multi-variable optimization routine which will attempt to minimize any cost function by varying a search vector. A modified Rosenbrock search routine is used in the example program, although a wide variety of possible methods exists. Figure 273 is a flow chart of the Rosenbrock routine used - A more detailed description is in Optimization -- Theory and Practice by G. S. G. Beveridge and R. S. Schechter. The cost or mismatch function, described previously in this appendix, is a scalar sum of the squares of gain and phase differences between the low- and high-order frequency responses. The cost function subsection requires the frequency response of the current low-order system in order to calculate the mismatch. The convergence criteria determine whether an optimum match has been found. In the example program, convergence is considered optimum when the search vector changes by less than 0.001 percent between iterations.

Output -- This section presents the results of the Search section to the user. The final optimum low-order system, the mismatch, and frequency responses of the high- and low-order systems are primary outputs.

The preceding example was intended to show how equivalent systems can be calculated, not how they must be. Although the example is based on an actual working program, the number of possible, equally good programs is limited only by the number and creativity of prospective users.

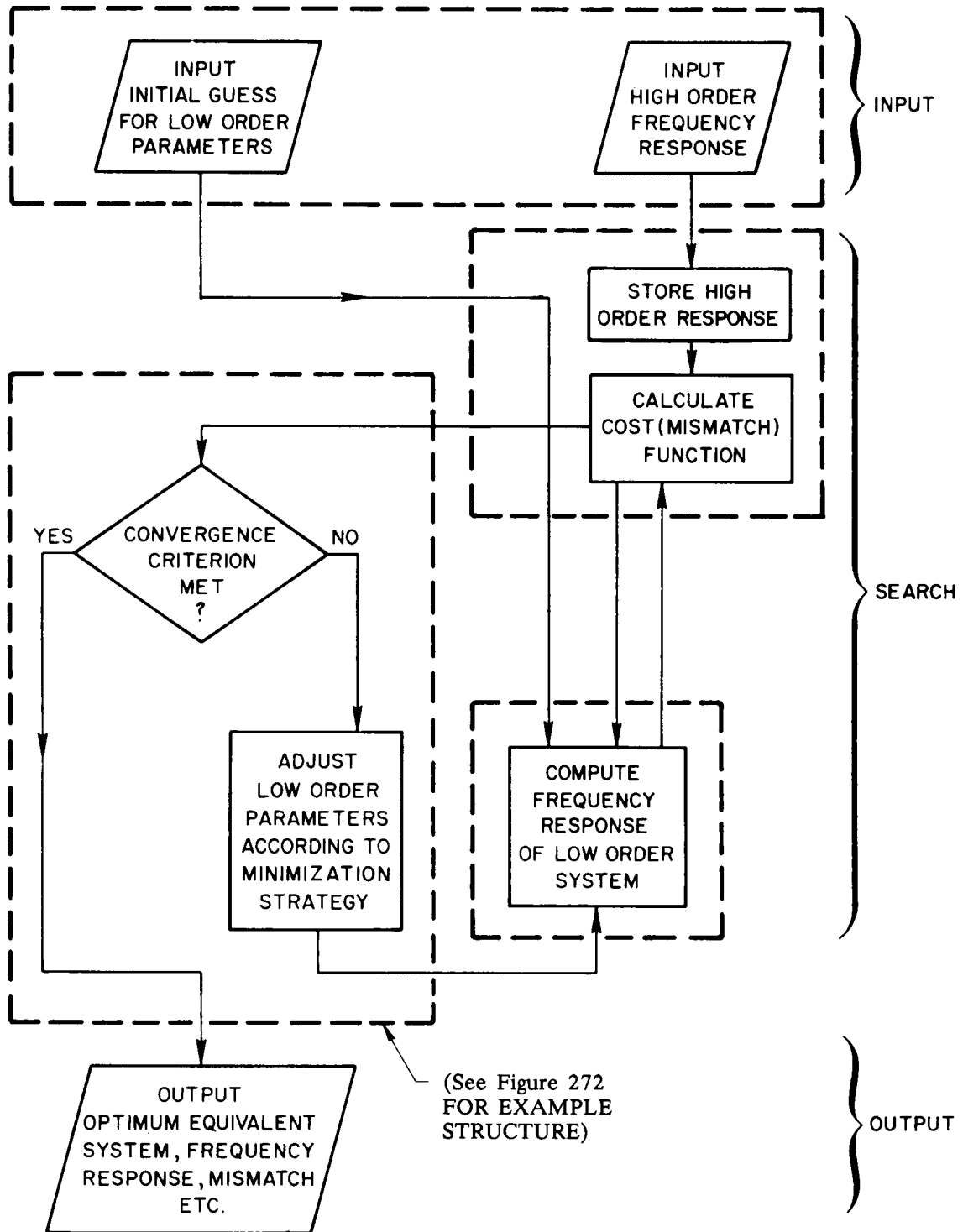

FIGURE 271. Simplified flow chart for equivalent system computer program.

MIL-STD-1797A
APPENDIX B

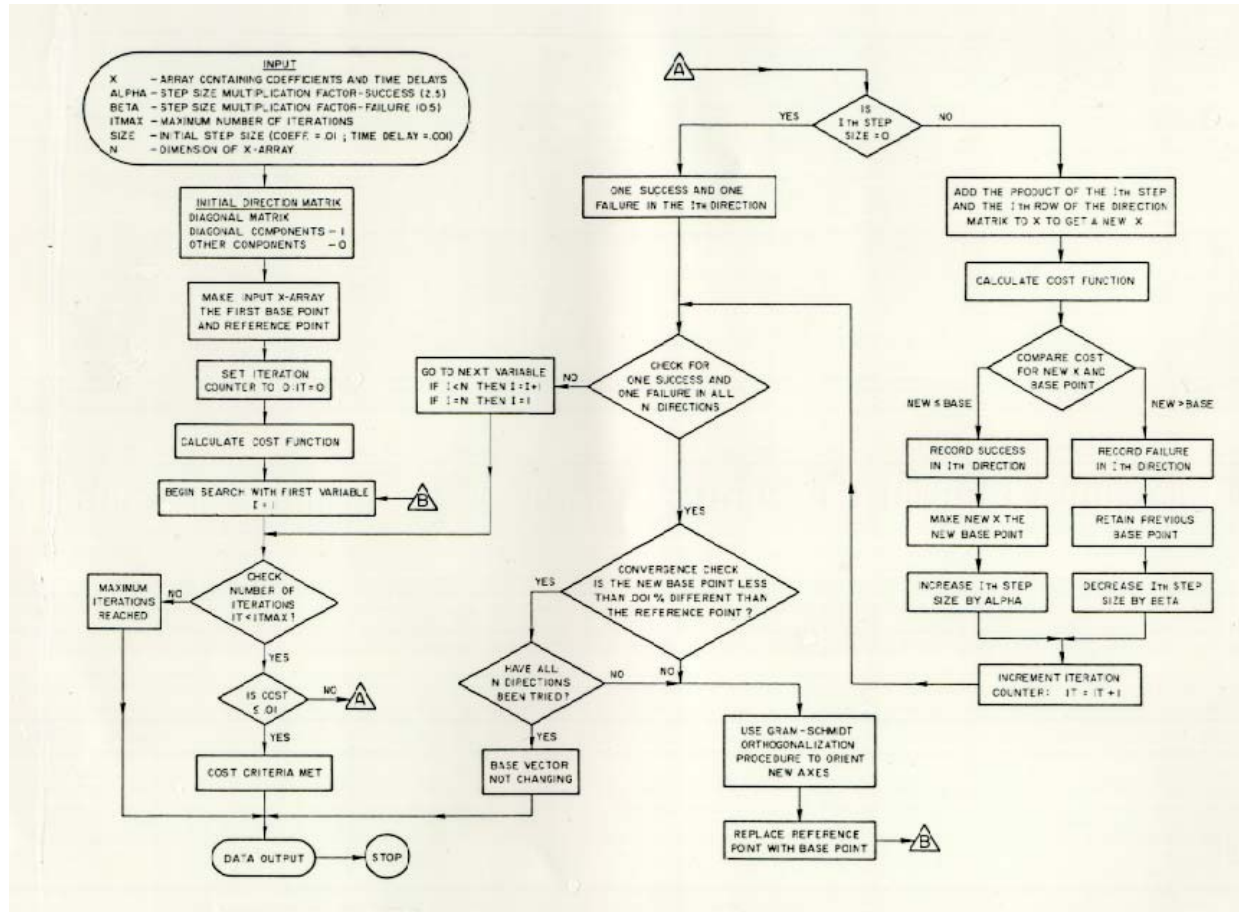

FIGURE 272. Flow Chart for a modified Rosenbrock search algorithm.

APPENDIX C

BACKGROUND INFORMATION AND CROSS REFERENCE

Although the term "flying qualities" is fairly descriptive in itself, W. H. Phillips' definition (NACA Report 927) is still apt:

The flying qualities of an airplane are defined as the stability and control characteristics that have an important bearing on the safety of flight and on the pilots' impressions of the ease of flying an airplane in steady flight and in maneuvers.

So is Cooper and Harper's definition (NASA TN D-5153) of the synonymous term, handling qualities:

Those qualities or characteristics of an aircraft that govern the ease and precision with which a pilot is able to perform the tasks required in support of an aircraft role.

Cooper and Harper state further that the context is important:

The term "handling qualities" requires clear definition in order to emphasize that it includes more than just stability and control characteristics. Other factors that influence the handling qualities are the cockpit interface (e.g., displays, controls), the aircraft environment (e.g., weather conditions, visibility, turbulence) and stress, the effects of which cannot readily be segregated. Thus in most tests, handling qualities are really being evaluated in the aggregate.

Flying qualities encompass whatever is involved in flying the aircraft (and in piloting it on the ground) safely and in performance of operational missions, from the point of view of the pilot. To the extent possible, the specification translates these operational needs into terms of aircraft performance-type parameters that have been correlated with safety and mission effectiveness.

This standard is to be used to procure aircraft, which are to be flown by the available cadre of military pilots. Specification of design parameters such as tail size or stability derivatives is not allowed, for good reason: these details, far removed from mission effectiveness, are the province of the designer. On the other hand, mission performance terms such as probability of kill or touchdown dispersion are not acceptable parameters for specifying flying qualities. These are too dependent on other subsystems, and on pilots who vary among themselves and even from run to run (for example, AFFTC has found the Handling Qualities During Tracking (HQDT) technique an excellent way to discover handling problems. Pilot comments are consistent, but run-to-run variability makes the measured performance useless). Requirements in these terms also give little design guidance, and compliance cannot be verified until flight test, years after the design is frozen.

If we can derive a sufficiently validated, accepted pilot model, we might be able to state flying qualities requirements very simply: within this range of pilot model parameters, this performance must be achieved. For the present, however, we continue the historical approach of specifying, to the extent practicable, aircraft response characteristics which will provide the pilots a safe, effective means of performing the intended missions.

This standard defines a general framework that permits tailoring each requirement according to:

- 1) The kind of aircraft (Mission and Class)
- 2) The job to be done (Flight Phase and Flight Envelope)
- 3) How well the job must be done (State and Level)

MIL-STD-1797A
APPENDIX C

The framework then comprises the scope and application described in this appendix and these paragraphs:

3.1 Aircraft classification and operational missions

3.2 Flight phase categories

3.3 Levels and qualitative suitability of flying qualities

Additional items which must be defined for each procurement or design are specified in section 4.1. General requirements: Flight envelopes, Aircraft failure states. etc.

We see this framework as necessary for a rational approach to flying qualities specification. While we have heard some users express fears that the cost and effort of designing to and showing compliance with requirements in this framework would be increased manifold, the following excerpt from the AFFDL/FGC 21-25 June 1971 Weekly Activity Report indicates that things are not all that bad.

12. _____ visited the Handling Qualities Group to discuss _____ experience in applying Military Specification, MIL-F-8785B in a recent study effort. The purpose of the effort was to establish a set of flying qualities requirements based on MIL-F-8785B to be applied in a weapon system development program and to take a preliminary look at the stability of the configuration to meet these requirements. The airplane in question was intended solely to conduct weapon delivery missions against ground targets. It was a relatively unsophisticated, subsonic airplane required to carry several external store complements, and to follow four mission profiles in the conduct of its basic air-to-ground weapon delivery operations. Applying the portions of the specification concerned with defining airplane normal and failure states and establishing flight envelopes at first appeared to be a task of monumental proportions, but, as it was necessary in order to identify the applicable MIL-F-8785B requirements, there was no way to avoid it. They found that defining the normal states for each flight phase was more of a bookkeeping problem than anything else. It was however, the only approach to insuring that the combination of configuration, loading, etc., that were critical with respect to each of the MIL-F-8785 requirements were identified. Because of this, and because of the improved understanding of all aspects of the total system that resulted, _____ felt that the effort involved was worthwhile. All that was required in this documentation effort with respect to flight envelopes was that the operational flight envelopes be constructed. Since these represent the speed, altitude and load factor capability necessary to complete the mission, consideration of the effect of external stores, etc., on airplane limitations was not necessary, which simplified the task a great deal. There was considerable overlap of the envelopes constructed by _____, which led to a manageable number of envelopes to be considered. _____ was very liberal in sizing these envelopes, realizing that larger envelopes enhanced the competitiveness of their design. They had not come to grips with the problem of providing Level 1 flying qualities within these large envelopes, and the impact on such things as system weight, cost, complexity, reliability, etc. They acknowledged that they might have had to reduce these envelopes because of these considerations, in order to be responsive to the need for a relatively simple system. The identification of system failures that would have an effect on flying qualities, and the assessment of the failure consequence in terms of degraded flying qualities were found to be straightforward.

The process of establishing the per flight probability of these failures presented no particular problem. _____ identified some failure modes through this evaluation which would not otherwise have been recognized. They did not have confidence in the

MIL-STD-1797A
APPENDIX C

accuracy of their failure probability analysis because of the inaccuracy in the system component failure rate data available in the open literature. Looking back on the application of MIL-F-8785B in this particular study, _____ concludes that it was by no means as big a problem as had been anticipated, and that the benefits throughout the service life of the airplane would have more than compensated for the additional design effort required. They would recommend no changes to MIL-F-8785B based on their experience in this application of the specification. (Wilson)

The first draft of this handbook, AFWAL-TR-3081, Vol. II, has been widely reviewed and extensively revised, and a second round of industry and service review conducted prior to adoption of this document.

Scope

This standard establishes the requirements and verifications for flying and ground handling qualities. It is intended to assure flying qualities for adequate mission performance and flight safety regardless of the design implementation, flight control system augmentation, or impact of other related subsystems.

The scope is essentially unchanged from that of MIL-F-8785C paragraph 1.1. The requirements are not aimed at unconventional aircraft such as helicopters, V/STOL, or re-entry vehicles, but many of the requirements may be found to apply reasonably well to those aircraft in specific instances. Separate flying qualities specifications are being prepared for helicopters, and we plan to extend coverage to STOL aircraft. Remotely piloted vehicles are not covered. The emphasis is on the complete aircraft, including its flight control system (and other subsystems) to the extent that they impact flying qualities. Such related subsystems might be propulsion, fuel, electrical, hydraulic, fire control,...

Flying qualities requirements for civil aircraft, e.g. Parts 23, 25, etc. of the Federal Aviation Regulations, generally are intended to regulate only the flight safety of the aircraft certificated. Suitability for the intended use is determined by the buyer. In practice, however, manufacturers of transport aircraft consult extensively with potential customers in designing both new aircraft and modifications to current models. The military services are customers, rather than regulators, when buying aircraft. When the procuring activity pays for the design, no suitable craft being available, it has been found necessary since the 1940s to specify flying qualities in some detail in the contract, in order to assure suitability for the intended missions as well as flight safety. Military Specifications/Standards have also served as criteria by which to judge the suitability of already-developed aircraft for intended military or civil uses, even in the absence of any contractually binding flying qualities requirements.

Application

The flying qualities of the proposed or contracted aircraft are to be in accordance with the provisions of MIL-STD-1797. The requirements apply as stated to the combination of airframe and related subsystems. Stability augmentation and control augmentation are specifically to be included when provided in the aircraft. The change here pertains to the way in which the requirements are now organized, i.e., by axis. The Standard applies to that system which the pilot controls and which responds to disturbances.

The Standard is used in a number of ways, for several purposes, by people with varied interests. It also treats a rather complicated subject. Thus no one organization of the material will be found optimum by any particular user. This change from the order of presentation in MIL-F-8785C is an attempt to facilitate use.

It has always been the intent that flying qualities requirements apply to the system that the pilot "sees", or feels. This intent, which has been implicit, has been made explicit because of questions arising out of use of more elaborate stability and control augmentation systems.

MIL-STD-1797A
APPENDIX C

Additional insight on the intended application of this standard is given in MIL-F-8785C Intended use:

This specification contains the handling qualities requirements for piloted aircraft and forms one of the bases for determination by the procuring activity of aircraft acceptability. The specification consists of requirements in terms of criteria for use in stability and control calculations, analysis of wind tunnel test results, simulator evaluations, flight testing, etc. The requirements should be met as far as possible by providing an inherently good basic airframe. Cost, performance, reliability, maintenance, etc. tradeoffs are necessary in determining the proper balance between basic airframe characteristics and augmented dynamic response characteristics. The contractor should advise the procuring activity of any significant design penalties which may result from meeting any particular requirement.

Because changes become more difficult and costly to make as the design progresses, a specific review early in the program will be found very helpful in assessing the impact of design penalties imposed by the flying qualities requirements. Also, to assure adequate instrumentation and testing for verification it is important to involve the responsible test organization from the early stages.

Other factors

Changes of mechanical gearings and stability augmentation gains in the primary flight control system are sometimes accomplished by scheduling the changes as a function of the settings of secondary control devices, such as ailerons or wing sweep. This practice is generally acceptable, but gearings and gains normally should not be scheduled as a function of trim control settings since pilots do not always keep aircraft in trim.

Secondary effects of engine operations may have an important bearing on flying qualities and should not be overlooked in design. These considerations include: the influence of engine gyroscopic moments on aircraft airframe dynamic motions; the effects of engine operations (including flameout and intentional shutdown) on characteristics of flight at high angle of attack; and the reduction at low rpm of engine-derived power for operating the flight control system.

Since aeroelasticity, control equipment and structural dynamics may exert an important influence on the aircraft flying qualities, such effects should not be overlooked in calculations or analyses directed toward investigation of compliance with the requirements of this standard.

Some of the important mechanical characteristics of control systems (including servo valves and actuators) are: friction and preload, lost motion, flexibility, mass imbalance and inertia, nonlinear gearing, and rate limiting. Requirements for some of these characteristics are given, but meeting those separate requirements will not necessarily ensure that the overall system will be adequate; the mechanical characteristics must be compatible with the nonmechanical portions of the control system and with the airframe dynamic characteristics.

Simulation is only as good as its accuracy in representing the aircraft, the task, and the environment. As a verification tool it must faithfully represent the aircraft characteristics being evaluated. Thus, in the end flight-validated aerodynamic data and an accurate representation of the flight control system are necessary. Even so, less than real-world visual and motion cues can be expected to influence pilots' evaluations of some characteristics in ground-based simulators. In any case the evaluation can be no better than the input data and the evaluation tasks. (Also, see RAE Rpt Aero 2688 and RAE-TR-68022.)

MIL-STD-1797A APPENDIX C

Concept of the standard and handbook

MIL-STD-1797 is a skeleton document consisting of incomplete requirements in verbal form which are to be completed by the procuring activity using quantitative and qualitative criteria from Appendix A. A filled in document will be developed for each new aircraft procurement or major modification of an existing aircraft, as follows:

- 1) Identify mission requirements.
- 2) Break down requirements into piloting tasks.
- 3) For each paragraph in MIL-STD-1797, select the most appropriate handling quality criterion from Appendix A and insert into the Standard.

The procedure results in a customized handling quality standard for each new aircraft or modification of an existing aircraft. The purpose of this revised format is to facilitate tailoring a detailed handling quality standard to the particular mission requirements of the aircraft being acquired. Such a tailoring will need time. Be forewarned that an early start is necessary.

Organization of the standard and handbook

The MIL Standard and Handbook criteria are presented in terms of aircraft response or control axes, which represents a significant change from MIL-F-8785C where the criteria were presented in terms of modes. This change is to better accommodate highly augmented aircraft, a primary objective of MIL-STD-1797. Also, allowance is made for requirements on linear responses along each axis, and responses to "primary," "secondary," and "other" controllers are specified. The standard is written in terms of the customary cockpit controllers: center or side stick, or wheel and column for pitch and roll; pedals for yaw; throttle and speed brake control for thrust/drag. Direct lift and side-force controllers are also provided. However, the manufacturer has some freedom to select which of these controls is primary in each axis. For example, in-the Advanced Medium STOL Transport (AMST) program Douglas selected throttles as the primary flight path controller, whereas Boeing selected pitch attitude.

Generally all the control power, control force, and control displacement requirements pertaining to given controller are put under the primary axis for which that controller is intended. With six degrees of freedom and (conventionally) four controllers, this is not a perfect fit. Thus control force per g and normal load factor capability are specified under the pitch axis in 4.2.

Utilizing this format results in some requirements for which there are, at this time, no criteria sufficiently developed to be included as a specification. In such cases a skeleton criterion is given in the standard and the reasons for such a criterion are included in the handbook.

Finding one's way through the Handbook has been facilitated by starting every requirement on a fresh page.

Many readers will want to locate corresponding paragraphs for MIL-F-8785C and MIL-STD-1797A. The following table is given to simplify such correlations, cross-referencing MIL-F-8785C to MIL-STD-1797A. The corresponding MIL-F-8785C paragraphs are also listed in the handbook's guidance for each requirement.

MIL-STD-1797A
APPENDIX C

Verification

"Quality Assurance" was presented as section 4 in MIL-F-8785C. Inasmuch as quality assurance contains the acceptable methods for demonstrating compliance with the requirement, in the handbook (Appendix A to this standard) "Verification" (section 5 of the MIL Standard) for each flying qualities requirement immediately follows the requirement rather than being part of a separate section 5 of the handbook.

In the handbook, the rationale for each verification requirement gives guidance on verification techniques, while the verification guidance offers help in selecting critical flight conditions. Equations offered there are such helps; they are generally approximations applicable to conventional designs and as such are not suitable for more than preliminary verification.

The verification requirements of this standard are quite general. Typically, different types and levels of verification are appropriate at various stages: conceptual design, preliminary design, detail design, and flight test. As the design progresses, the aircraft will become better defined through wind tunnel tests, subsystem definition, more detailed analyses, and component testing, simulation, and flight testing. While all the requirements must be checked, emphasis should be on (a) the most critical requirements and flight conditions for a particular mission and configuration and (b) verification methods appropriate to the quality of the data.

In flight testing, constraints due to cost, hazard, or practicality, and emphasis on operational capability, generally will preclude quantitative verification of compliance with more than a selected sample of the requirements. For those conditions too hazardous or impractical to attempt, evaluation should be accomplished on a validated simulator. For the rest, qualitative evaluations can be used to indicate problem areas that need more detailed investigation; and parameter identification techniques can validate or update the analytical model upon which the flying qualities predictions were based. One technique used to evaluate aircraft response characteristics and concurrently verify compliance with requirements is Handling Qualities During Tracking, as reported by Twisdale and Franklin in AFFTC-TD-75-1.

MIL-STD-1797A
APPENDIX C

Numerical cross-index from MIL-F-8785C to Appendix A

MIL-F-8785C PARAGRAPH	MIL-F-1797 PARAGRAPH TITLE	MIL-STD-1797 PARAGRAPH	PAGE NO. IN THIS DOCUMENT
1.1	Scope	Forward, 1.1, Appendix C	iii, 1, 689
1.2	Application	See Appendix C	689
1.3	Classification of airplanes	3.1	76
1.3.1	Land- or carrier-based designation	3.1	76
1.4	Flight Phase Categories	3.2	80
1.5	Levels of flying qualities	3.3	85
2.1	Issues of documents	2.1.1	57
3.1.1	Operational missions	3.1	76
3.1.2	Loadings	4.1.1	89
3.1.3	Moments and products of inertia	4.1.2	91
3.1.4	External stores	4.1.3	92
3.1.5	Configurations	4.1.5	105
3.1.6	State of the airplane	4.1.5	105
3.1.6.1	Airplane Normal States	4.1.6	107
3.1.6.2	Airplane Failure States	4.1.7	110
3.1.6.2.1	Airplane Special Failure States	4.1.7.2	112
3.1.7	Operational Flight Envelopes	4.1.4.1	96
3.1.8	Service Flight Envelopes	4.1.4.2	100
3.1.8.1	Maximum service speed	4.1.4.2	100
3.1.8.2	Minimum service speed	4.1.4.2	100
3.1.8.3	Maximum service altitude	4.1.4.2	100
3.1.8.4	Service load factors	4.1.4.2	100
3.1.9	Permissible Flight Envelopes	4.1.4.3	103
3.1.10	Application of Levels	4.1.6.1, 4.1.7.3, 4.1.7.4	108, 114, 123

MIL-STD-1797A
APPENDIX C

MIL-F-8785C PARAGRAPH	MIL-F-1797 PARAGRAPH TITLE	MIL-STD-1797 PARAGRAPH	PAGE NO. IN THIS DOCUMENT
3.1.10.1	Requirements for Airplane Normal States	4.1.6.1, 4.1.7.3, 4.1.7.4	108, 114, 123
3.1.10.2	Requirements for Airplane Failure States	4.1.7.3	114
3.1.10.2.1	Requirements for specific failures	4.1.7.4	123
3.1.10.3.1	Ground operation and terminal Flight Phases	4.1.6.3	108
3.1.10.3.2	When Levels are not specified	4.1.7.5	126
3.1.10.3.3	Flight outside the Service Flight Envelope	4.1.6.2, 4.1.7.6	108, 127
3.1.11	Interpretation of subjective requirements	4.1.9	130
3.1.12	Interpretation of quantitative requirements	4.1.10, 4.2.1.2, 4.5.1.5, 4.6.1.1	131, 171, 419, 515
3.2.1.1	Longitudinal static stability	4.4.1	370
3.2.1.1.1	Relaxation in transonic flight	4.4.1.1	375
3.2.1.1.2	Pitch control force variations during rapid speed changes	4.2.8.3	326
3.2.1.2	Phugoid stability	4.2.1.1	167
3.2.1.3	Flight-path stability	4.3.1.2	357
3.2.2.1	Short-period response	4.2.1.2	171
3.2.2.1.1	Short-period frequency and acceleration sensitivity	4.2.1.2	171
3.2.2.1.2	Short-period damping	4.2.1.2	171
3.2.2.1.3	Residual oscillations	4.1.11.7, 4.2.3	153, 276
3.2.2.2	Control feel and stability in maneuvering flight at constant speed	4.2.8.1, 4.2.9.2	302, 351
3.2.2.2.1	Control forces in maneuvering flight	4.2.8.1	302
3.2.2.2.2	Control motions in maneuvering flight	4.2.8.4, 4.2.9.2	327, 351

MIL-STD-1797A
APPENDIX C

MIL-F-8785C PARAGRAPH	MIL-F-1797 PARAGRAPH TITLE	MIL-STD-1797 PARAGRAPH	PAGE NO. IN THIS DOCUMENT
3.2.2.3	Longitudinal pilot-induced oscillations	4.1.11.6, 4.2.2	151, 267
3.2.2.3.1	Dynamic control forces in maneuvering flight	4.2.8.2	318
3.2.2.3.2	Control feel	4.2.8.2, 4.2.8.4	318, 327
3.2.3.1	Longitudinal control in unaccelerated flight	4.2.7.1	287
3.2.3.2	Longitudinal control in maneuvering flight	4.2.7.2	288
3.2.3.3	Longitudinal control in takeoff	4.2.7.3, 4.2.9.1	292, 349
3.2.3.3.1	Longitudinal control in catapult takeoff	4.2.7.3	292
3.2.3.3.2	Longitudinal control force and travel in takeoff	4.2.8.6.1, 4.2.9.1	337, 349
3.2.3.4	Longitudinal control in landing	4.2.7.4	295
3.2.3.4.1	Longitudinal control forces in landing	4.2.8.6.2	339
3.2.3.5	Longitudinal control forces in dives – Service Flight Envelope	4.2.8.6.3	341
3.2.3.6	Longitudinal control forces in dives – Permissible Flight Envelope	4.2.8.6.3	341
3.2.3.7	Longitudinal control in sideslips	4.2.8.6.4	343
3.3.1.1	Lateral-directional oscillations (Dutch roll)	4.1.11.7, 4.6.1.1	153, 505
3.3.1.2	Roll mode	4.5.1.1	377
3.3.1.3	Spiral stability	4.5.1.2	392
3.3.1.4	Coupled roll-spiral oscillation	4.5.1.3	396
3.3.2	Lateral-directional dynamic response characteristics	4.5.1	377
3.3.2.1	Lateral-directional response to atmospheric disturbances	(No specific requirement)	--
3.3.2.2	Roll rate oscillations	4.5.1.4	404

MIL-STD-1797A
APPENDIX C

MIL-F-8785C PARAGRAPH	MIL-F-1797 PARAGRAPH TITLE	MIL-STD-1797 PARAGRAPH	PAGE NO. IN THIS DOCUMENT
3.3.2.2.1	Additional roll rate requirement for small inputs	4.5.1.4	404
3.2.2.3	Bank angle oscillations	4.5.1.4	404
3.3.2.4	Sideslip excursions	4.6.2	540
3.3.2.4.1	Additional sideslip requirement for small inputs	4.6.2	540
3.3.2.5	Control of sideslip in rolls	4.6.7.1	587
3.3.2.6	Turn coordination	4.5.9.5.1, 4.6.7.2	497, 588
3.3.3	Pilot-induced oscillations	4.1.11.6, 4.5.1, 4.6.3	151, 377, 570
3.3.4	Roll control effectiveness	4.5.8.1	434
3.3.4.1	Roll performance for Class IV airplanes	4.5.8.1	434
3.3.4.1.1	Roll performance in Flight Phase CO	4.5.8.1	434
3.3.4.1.2	Roll performance n Flight Phase GA	4.1.11.2, 4.5.8.1, 4.5.8.6	137, 434, 469
3.3.4.1.3	Roll response	4.5.9.3	478
3.3.4.2	Roll performance for Class III airplanes	4.5.8.1	434
3.3.4.3	Roll control forces	4.5.9.2	476
3.3.4.4	Linearity of roll response	4.5.3	423
3.3.4.5	Wheel control throw	4.5.9.1	474
3.3.5	Directional control characteristics	4.6.6, 4.6.7	581, 586
3.3.5.1	Directional control with speed change	4.6.7.3	590
3.3.5.1.1	Directional control with asymmetric loading	4.6.6.3, 4.6.7.5	585, 592
3.3.5.2	Directional control in wave-off (go-around)	4.6.7.7	594
3.3.6	Lateral-directional characteristics in steady sideslips	4.5.5, 4.6.1.2	428, 528
3.3.6.1	Yawing moments in steady sideslips	4.6.1.2	528
3.3.6.2	Side forces in steady sideslips	4.5.5	428

MIL-STD-1797A
APPENDIX C

MIL-F-8785C PARAGRAPH	MIL-F-1797 PARAGRAPH TITLE	MIL-STD-1797 PARAGRAPH	PAGE NO. IN THIS DOCUMENT
3.3.6.3	Roll moments in steady sideslips	4.5.5	428
3.3.6.3.1	Exception for wave-off (go-around)	4.5.5	428
3.3.6.3.2	Positive effect dihedral limit	4.5.8.2, 4.5.9.5.4	462, 501
3.3.7	Lateral-directional control in crosswinds	4.5.6, 4.5.8.3, 4.5.9.5.3, 4.6.4, 4.6.7.4	430, 463, 500, 571, 582
3.3.7.1	Final approach in crosswinds	4.5.8.3, 4.5.9.5.4, 4.6.6.1	463, 501, 582
3.3.7.2	Takeoff run and landing rollout in crosswinds	4.5.8.3, 4.6.6.1	463, 582
3.3.7.2.1	Cold- and wet-weather operation	4.6.6.1	582
3.3.7.2.2	Carrier-based airplanes	4.6.6.1	582
3.3.7.3	Taxiing wind speed limits	4.5.8.3, 4.6.6.1	463, 582
3.3.8	Lateral-directional control in dives	4.5.8.5, 4.5.9.5.2, 4.6.7.6	468, 499, 593
3.3.9	Lateral-directional control with asymmetric thrust	4.5.8.4, 4.6.5.1, 4.6.6.2	454, 562, 584
3.3.9.1	Thrust loss during takeoff run	4.6.5.1, 4.6.6.2, 4.6.7.8	574, 584, 595
3.3.9.2	Thrust loss during takeoff	4.5.8.4, 4.5.9.5.5, 4.6.5.1, 4.6.6.2, 4.6.7.8	466, 502, 574, 584, 595
3.3.9.3	Transient effects	4.6.5.1, 4.6.6.2	574, 584
3.3.9.4	Asymmetric thrust – yaw controls free	4.5.9.5.5, 4.6.5.1, 4.6.6.2	502, 574, 584
3.3.9.5	Two engines inoperative	4.6.6.2	584
3.4.1	Dangerous flight conditions	4.1.8	128
3.4.1.1	Warning and indication	4.1.8.1, 4.8.4.1	128, 616
3.4.1.2	Devices for indication, warning, prevention, recovery	4.1.8.2	128
3.4.2	Flight at high angle of attack	4.8.4	610
3.4.2.1	Stalls	4.8.4.2	618
3.4.2.1.1	Stall approach	4.8.4.2.1	620
3.4.2.1.1.1	Warning speed for stalls at 1 g normal to the flight path	4.8.4.2.1	620

MIL-STD-1797A
APPENDIX C

MIL-F-8785C PARAGRAPH	MIL-F-1797 PARAGRAPH TITLE	MIL-STD-1797 PARAGRAPH	PAGE NO. IN THIS DOCUMENT
3.4.2.1.1.2	Warning range for accelerated stalls	4.8.4.2.1	620
3.4.2.1.2	Stall characteristics	4.8.4.2.2	623
3.4.2.1.3	Stall prevention and recovery	4.8.4.2.3	625
3.4.2.1.3.1	One-engine-out stalls	4.8.4.2.4	629
3.4.2.2	Post-stall gyrations and spins	4.8.4.3	631
3.4.2.2.1	Departure from controlled flight	4.8.4.3.1	635
3.4.2.2.2	Recovery from post-stall gyrations and spins	4.8.4.3.2	643
3.4.3	Cross-axis coupling in roll maneuvers	4.1.11.8, 4.8.1	154, 602
3.4.4	Control harmony	4.8.3	608
3.4.4.1	Control force coordination	4.8.3	608
3.4.5	Buffet	4.1.11.1	134
3.4.6	Release of stores	4.1.11.2	137
3.4.7	Effects of armament delivery and special equipment	4.1.11.3	138
3.4.8	Transients following failures	4.1.11.4, 4.5.7.1, 4.6.5.2	139, 431, 579
3.4.9	Failures	4.1.8, 4.1.8.1, 4.1.8.2, 4.1.11.4, 4.5.7.1, 4.6.5.2	128, 128, 128 139, 531, 599
3.4.10	Control margin	4.1.11.5	143
3.4.11	Direct force controls	4.1.11.8, 4.1.12.11, 4.3.2, 4.3.3, 4.6.1.3, 4.7.1	154, 159, 367 368, 531, 599
3.5.1	General characteristics	4.1.12	156
3.5.2	Mechanical characteristics	See Appendix C	
3.5.2.1	Control centering and breakout forces	4.1.12.1, 4.2.8.5, 4.3.4, 4.5.9.4, 4.6.7.11	156, 336, 368, 496, 598
3.5.2.2	Cockpit control free play	4.1.12.2	156
3.5.2.3	Rate of control displacement	4.1.12.4	159
3.5.2.4	Adjustable controls	4.1.12.3	156
3.5.3	Dynamic characteristics	4.1.12.5, 4.2.1.2, 4.5.1.5	159, 171, 419

MIL-STD-1797A
APPENDIX C

MIL-F-8785C PARAGRAPH	MIL-F-1797 PARAGRAPH TITLE	MIL-STD-1797 PARAGRAPH	PAGE NO. IN THIS DOCUMENT
3.5.3.1	Damping	4.1.12.6	159
3.5.4	Augmentation systems	4.1.12.9	159
3.5.5	Failures	4.1.12.8	159
3.5.5.1	Failure transients	3.2.6, 4.5.7.1, 4.6.5.2	283, 431, 579
3.5.5.2	Trim changes due to failures	4.2.8.6.5, 4.5.9.5.6, 4.6.7.9	345, 503, 596
3.5.6	Transfer to alternate control modes	4.1.12.7, 4.2.6.2, 4.6.5.3	159, 285, 580
3.5.6.1	Transfer transients	4.2.6.2, 4.5.7.2, 4.6.5.3	285, 433, 580
3.5.6.2	Trim changes	4.2.6.2, 4.2.8.6.6, 4.5.7.2, 4.5.9.5.7, 4.6.5.3, 4.6.7.10	285, 346, 433, 504, 580, 517
3.6.1	Trim system	4.2.8.7	347
3.6.1.1	Trim for asymmetric thrust	4.1.13.5	164
3.6.1.2	Rate of trim operation	4.1.13.2, 4.2.8.6.3	164, 341
3.6.1.3	Stalling of trim systems	4.1.13.3	164
3.6.1.4	Trim system irreversibility	4.1.13.1	164
3.6.2	Speed and flight path control devices	4.1.11.8, 4.3.1.2, 4.3.2	154, 357, 367
3.6.3	Transients and trim changes	4.1.11.8, 4.1.12.10, 4.1.13.4	154, 159, 164
3.6.3.1	Pitch trim changes	4.2.5	281
3.6.4	Auxiliary dive recovery devices	4.1.11.8	154, 159
3.7.1	Form of the disturbance models	4.1.12.10	657
3.7.1.1	Turbulence model (von Karman form)	4.9.2	657
3.7.1.2	Turbulence model (Dryden form)	4.9.2	657
3.7.1.3	Discrete gust model	4.9.2	657
3.7.2	Medium/high-altitude model	4.9.2	657
3.7.2.1	Turbulence scale lengths	4.9.2	657
3.7.2.2	Turbulence intensities	4.9.2	657
3.7.2.3	Gust intensities	4.9.2	657
3.7.2.4	Gust magnitudes	4.9.2	657

MIL-STD-1797A
APPENDIX C

MIL-F-8785C PARAGRAPH	MIL-F-1797 PARAGRAPH TITLE	MIL-STD-1797 PARAGRAPH	PAGE NO. IN THIS DOCUMENT
3.7.3	Low-altitude disturbance models	4.9.2	657
3.7.3.1	Wind speeds	4.9.2	657
3.7.3.2	Wind shear	4.9.2	657
3.7.3.3	Vector shear	4.9.2	657
3.7.3.4	Turbulence	4.9.2	657
3.7.3.5	Gusts	4.9.2	657
3.7.4	Carrier-landing disturbance model	4.9.2	657
3.7.4.1	Free-air turbulence components	4.9.2	657
3.7.4.2	Steady component of carrier airwake	4.9.2	657
3.7.4.3	Periodic component of carrier airwake	4.9.2	657
3.7.4.4	Random component of carrier airwake	4.9.2	657
3.7.5	Application of the disturbance model in analysis	4.9.3	680
3.8	Requirements for use of the disturbance models	4.9.1	649
3.8.1	Use of disturbance models	4.9.1	649
3.8.2	Qualitative degrees of suitability	3.3	85
3.8.3	Effects of atmospheric disturbances	4.1.6.1, 4.1.6.2, 4.1.6.3, 4.9.1	108, 108, 108, 649
3.8.3.1	Requirements for Airplane Normal	4.1.6.1, 4.1.6.2, 4.1.6.3, 4.9.1	108, 108, 108, 649
3.8.3.2	Requirements for Airplane Failure States	4.9.1	649
4.1	Compliance demonstration	Section 5 (See the	
4.1.1.1	Effects of Failure States	individual requirements in	
4.1.1.2	Effects of atmospheric disturbances	the handbook for	
4.1.1.3	Computation assumptions	rationale, guidance and	
4.1.2	Simulation	lessons learned	

MIL-STD-1797A
APPENDIX C

MIL-F-8785C PARAGRAPH	MIL-F-1797 PARAGRAPH TITLE	MIL-STD-1797 PARAGRAPH	PAGE NO. IN THIS DOCUMENT	
4.1.3	Flight test demonstration	↓		
4.2	Airplane States			
4.2.1	Weights and moments of inertia			
4.2.2	Center-of-gravity positions			
4.2.3	Thrust settings			
4.3.1	Altitudes			
4.3.2	Special conditions			
4.4	Tests at specialized facilities		5.8.4.3.2 Rationale	647
6.1	Intended use		6.1	53
6.2	Definitions		3.4	2
6.2.1	General	3.4.1	2	
6.2.2	Speed	3.4.2	3	
6.2.3	Thrust and power	3.4.3	5	
6.2.4	Control parameters	3.4.4	6	
6.2.5	Longitudinal parameters	3.4.5	6	
6.2.6	Lateral-directional parameters	3.4.6	8	
6.2.7	Atmospheric disturbance parameters	3.4.7	16	
6.2.8	Terms used in high angle of attack requirements	3.5	18	
6.3	Interpretation of F_s/n limits of table V	4.2.8.1 Guidance	302	
6.4	Gain scheduling	Appendix C	687	
6.5	Engine considerations	Appendix C	687	
6.6	Effects of aeroelasticity, control, equipment and structural dynamics	Appendix C	687	
6.7	Application of Levels	4.1.7.1, 4.1.7.3, 4.1.7.4	111, 114, 123	
6.7.1	Level definitions	3.3	85	
6.8	Related documents	20	57	

STANDARDIZATION DOCUMENT IMPROVEMENT PROPOSAL

INSTRUCTIONS

1. The preparing activity must complete blocks 1, 2, 3, and 8. In block 1, both the document number and revision letter should be given.
2. The submitter of this form must complete blocks 4, 5, 6, and 7.
3. The preparing activity must provide a reply within 30 days from receipt of the form.

NOTE: This form may not be used to request copies of documents, nor to request waivers, or clarification of requirements on current contracts. Comments submitted on this form do not constitute or imply authorization to waive any portion of the referenced document(s) or to amend contractual requirements.

I RECOMMEND A CHANGE:

1. DOCUMENT NUMBER
MIL-STD-1797A

2. DOCUMENT DATE (YYMMDD)
900130

3. DOCUMENT TITLE
FLYING QUALITIES OF PILOTED AIRCRAFT

4. NATURE OF CHANGE (Identify paragraph number and include proposed rewrite, if possible. Attach extra sheets as needed.)

5. REASON FOR RECOMMENDATION

6. SUBMITTER

a. NAME (Last, Middle Initial)

b. ORGANIZATION

c. ADDRESS (include Zip Code)

d. TELEPHONE (Include Area Code
(1) Commercial

e. DATE SUBMITTED
(YYMMDD)

(2) AUTOVON
(If applicable)

8. PREPARING ACTIVITY

a. NAME

ASC/ENSI (AF-11)

b. TELEPHONE (Include Area Code

(1) Commercial
(513)255-6281

(2) AUTOVON
785-6281

c. ADDRESS (Include Zip Code)
ASC/ENSI BLDG 560
2530 LOOP ROAD W
WRIGHT-PATTERSON AFB OH 45433-7101

IF YOU DO NOT RECEIVE A REPLY WITHIN 45 DAYS, CONTACT:

Defense Quality and Standardization Office
5203 Leesburg Pike, Suite 1403, Falls Church, VA 22041-3466
Telephone (703) 756-2340 AUTOVON 289-2340