

-12793

PB93-910408
NTSB/AAR-93/07

NATIONAL TRANSPORTATION SAFETY BOARD

WASHINGTON, D.C. 20594

AIRCRAFT ACCIDENT REPORT

INADVERTENT IN-FLIGHT SLAT DEPLOYMENT
CHINA EASTERN AIRLINES FLIGHT 583
McDONNELL DOUGLAS MD-11, B-2171
950 NAUTICAL MILES SOUTH OF SHEMYA, ALASKA
APRIL 6, 1993

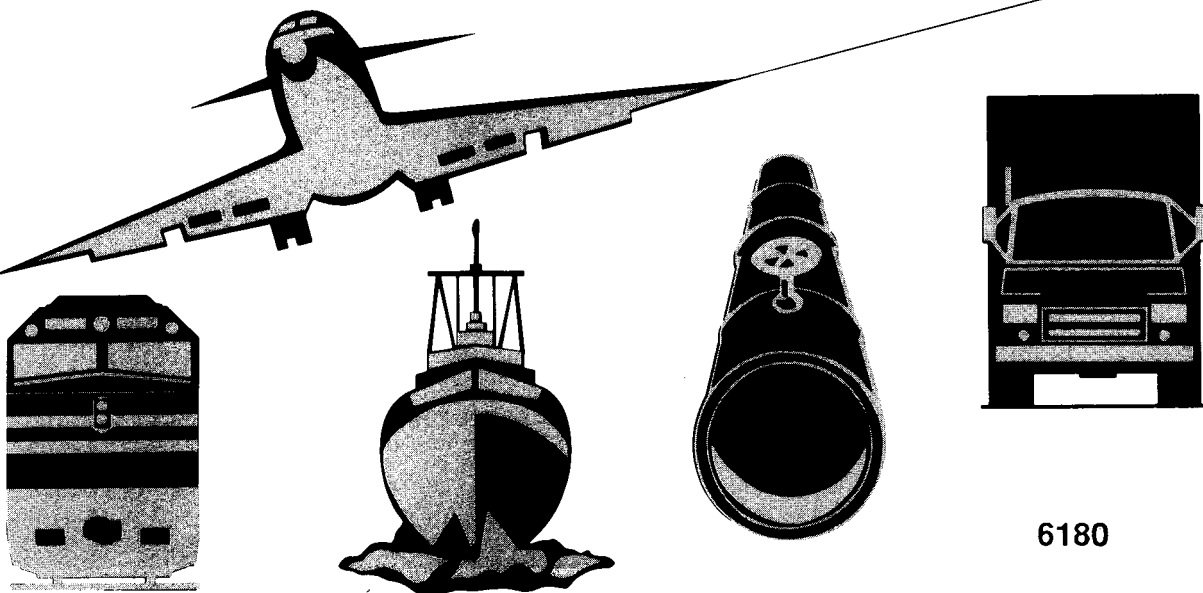

6180

The National Transportation Safety Board is an independent Federal agency dedicated to promoting aviation, railroad, highway, marine, pipeline, and hazardous materials safety. Established in 1967, the agency is mandated by Congress through the Independent Safety Board Act of 1974 to investigate transportation accidents, determine the probable causes of the accidents, issue safety recommendations, study transportation safety issues, and evaluate the safety effectiveness of government agencies involved in transportation. The Safety Board makes public its actions and decisions through accident reports, safety studies, special investigation reports, safety recommendations, and statistical reviews.

Information about available publications may be obtained by contacting:

National Transportation Safety Board
Public Inquiries Section, RE-51
490 L'Enfant Plaza, S.W.
Washington, D.C. 20594
(202)382-6735

Safety Board publications may be purchased, by individual copy or by subscription, from:

National Technical Information Service
5285 Port Royal Road
Springfield, Virginia 22161
(703)487-4600

NATIONAL TRANSPORTATION SAFETY BOARD

WASHINGTON, D.C. 20594

AIRCRAFT ACCIDENT REPORT

INADVERTENT IN-FLIGHT SLAT DEPLOYMENT
CHINA EASTERN AIRLINES FLIGHT 583
McDONNELL DOUGLAS MD-11, B-2171
950 NAUTICAL MILES SOUTH OF SHEMYA, ALASKA
APRIL 6, 1993

Adopted: October 27, 1993
Notation 6180

Abstract: This report explains the inadvertent deployment of the MD-11 airplane's leading edge wing slats while the airplane was in cruise flight, about 950 nautical miles south of Shemya, Alaska, on April 6, 1993. Safety issues in the report focused on the inadequate design of the flap/slat actuation handle, the inadvertent extension of the leading edge wing slats, the longitudinal stability of the airplane during the pitch upset, the pilot-induced oscillations that can occur during recovery, the premature deterioration of the seat cushion fire-blocking material, and the inability of the material to provide the required seat cushion fire protection on transport-category airplanes. Safety recommendations on these issues were made to the Federal Aviation Administration.

CONTENTS

EXECUTIVE SUMMARY	v
1. FACTUAL INFORMATION	
1.1 History of Flight	1
1.2 Injuries to Persons	5
1.3 Damage to Aircraft.....	6
1.4 Other Damage	6
1.5 Personnel Information	6
1.5.1 The Captain.....	6
1.5.2 The First Officer.....	6
1.5.3 The Flight Engineer	7
1.6 Aircraft Information.....	7
1.6.1 General	7
1.6.2 Leading Edge Slat System	8
1.6.3 Primary Flight Display.....	10
1.6.4 Slat Stow Lever.....	13
1.6.5 Centralized Fault Display Unit (CFDS)	16
1.7 Meteorological Information	16
1.8 Aids to Navigation	16
1.9 Communications.....	16
1.10 Aerodrome Information	17
1.11 Flight Recorders	17
1.12 Wreckage and Impact Information.....	18
1.12.1 External Damage Description	18
1.12.2 Aircraft Systems Examinations	19
1.12.2.1 Mechanical Systems	19
1.12.2.2 Electrical/Electronic Systems	20
1.12.2.3 Hydraulic Systems.....	21
1.12.3 Interior Damage Description.....	21
1.13 Medical and Pathological Information	23
1.14 Fire	25
1.15 Survival Aspects.....	25
1.16 Tests and Research.....	28
1.16.1 Flight Test	28
1.16.2 MD-11 Flight Characteristics, Autopilot, and Longitudinal Stability Augmentation System.....	30

1.17	Additional Information	32
1.17.1	Douglas Flightcrew Training Information	32
1.17.2	Summary of Other Reported In-flight Slat Extensions	33
1.17.3	MD-11 Slat System Service Bulletins	36
1.17.4	Passenger Seat Fire Retardant Conditions	38
1.17.5	Safety Board Recommendations Subsequent to the Accident	40
2.	ANALYSIS	
2.1	General	42
2.2	Inadvertent Slat Extension	43
2.2.1	Leading Edge Slat System	43
2.3	Flightcrew Performance	45
2.3.1	Slat Handle Contact	45
2.3.2	Pilot Control During the Upset	46
2.4	Analysis of CVR Failure	50
2.5	History of Inadvertent Slat Extensions	50
2.6	Occupant Seatbelt Usage	51
2.7	Passenger Seat Fire Protection	52
3.	CONCLUSIONS	
3.1	Findings	54
3.2	Probable Cause	56
4.	RECOMMENDATIONS	57
5.	APPENDIXES	
	Appendix A--Investigation and Hearing	61
	Appendix B--Response of Civil Aviation Administration of China to Safety Board's Draft of Aviation Accident Report	62

EXECUTIVE SUMMARY

On April 6, 1993, at 0110 Hawaiian Standard Time, China Eastern Airlines flight 583, a McDonnell Douglas MD-11, Chinese registration B-2171, a scheduled international passenger flight from Beijing, China, to Los Angeles, California, with an intermediate stop in Shanghai, China, had an inadvertent deployment of the leading edge wing slats while in cruise flight, approximately 950 nautical miles south of Shemya, Alaska. The autopilot disconnected, and the captain was manually controlling the airplane when it progressed through several violent pitch oscillations and lost 5,000 feet of altitude. The captain regained stabilized flight, declared an emergency because of passenger injuries, and diverted to the U. S. Air Force Base, Shemya, Alaska. Of the 235 passengers and 20 crewmembers aboard the airplane, 2 passengers were fatally injured, and 149 passengers and 7 crewmembers received various injuries. The airplane did not receive external structural damage, but the passenger cabin was substantially damaged.

The National Transportation Safety Board determines that the probable cause of this accident was the inadequate design of the flap/slat actuation handle by the Douglas Aircraft Company that allowed the handle to be easily and inadvertently dislodged from the UP/RET position, thereby causing extension of the leading edge slats during cruise flight. The captain's attempt to recover from the slat extension, given the reduced longitudinal stability and the associated light control force characteristics of the MD-11 in cruise flight, led to several violent pitch oscillations.

Contributing to the violence of the pitch oscillations was the lack of specific MD-11 pilot training in recovery from high altitude upsets, and the influence of the stall warning system on the captain's control responses. Contributing to the severity of the injuries was the lack of seat restraint usage by the occupants.

The safety issues in this report focused on the inadequate design of the flap/slat actuation handle on the MD-11 airplane, the inadvertent extension of the leading edge wing slats, the longitudinal stability of the MD-11 during the pitch upset, and the pilot-induced oscillations that can occur during the recovery. Also discussed is the premature deterioration of the seat cushion fire-blocking material and the inability of the material to provide the required seat cushion fire protection on transport-category airplanes.

Safety recommendations concerning these issues were addressed to the Federal Aviation Administration.

**NATIONAL TRANSPORTATION SAFETY BOARD
WASHINGTON, D.C. 20594**

AIRCRAFT ACCIDENT REPORT

INADVERTENT IN-FLIGHT SLAT DEPLOYMENT

**CHINA EASTERN AIRLINES FLIGHT 583
McDONNELL DOUGLAS MD-11, B-2171
950 NAUTICAL MILES SOUTH OF SHEMA, ALASKA
APRIL 6, 1993**

1. FACTUAL INFORMATION

1.1 History of Flight

On April 6, 1993, at 0110 Hawaiian Standard Time (HST), China Eastern Airlines flight 583 (CES583), a McDonnell Douglas MD-11, Chinese registration B-2171, a scheduled international passenger flight from Beijing, China, to Los Angeles, California, (LAX) with an intermediate stop in Shanghai, China, had an inadvertent deployment of the leading edge wing slats while in cruise flight, approximately 950 nautical miles south of Shemya, Alaska. The autopilot disconnected, and the captain was manually controlling the airplane when it progressed through several violent pitch oscillations and lost 5,000 feet of altitude. The captain regained stabilized flight, declared an emergency because of passenger injuries, and diverted to the U.S. Air Force Base, Shemya, Alaska. Of the 235 passengers and 20 crewmembers aboard the airplane, 2 passengers were fatally injured, and 149 passengers and 7 crewmembers received various injuries. The airplane received no external structural damage, but the passenger cabin interior was extensively damaged.

The flightcrew reported that the operation of the airplane from Beijing to its intermediate stop at Shanghai was normal. They also reported that the takeoff, climb and initial en route segment of the flight from Shanghai to Los Angeles were normal.

The airplane had been airborne about 5 hours, and the flight attendants had completed the meal service and had dimmed the lights for a movie when the airplane began the violent pitch oscillations.

The captain involved in the accident stated in an interview with Safety Board investigators that he was one of four members of the oncoming relief flightcrew that had assumed flight responsibilities of the airplane approximately 20 minutes prior to the event. The captain further stated that he was the flying pilot but occupied the right seat at the time of the accident because he was providing instruction to the first officer in the left seat.

At the time of the accident, the airplane was in cruise flight at 33,000 feet (FL330), above the clouds, at an indicated airspeed of approximately 298 knots (Mach 0.82) with the No. 1 autopilot engaged. The captain stated that they had not experienced any "unusual weather phenomenon" until approximately 15 minutes prior to the event. At that time, the airplane encountered what he described as "light" turbulence, and he turned on the seatbelt sign. He also stated that shortly thereafter, the "turbulence increased;" however, the flight attendants and most passengers stated that the "flight had been smooth" and the seatbelt sign had been off until the initial pitch oscillation occurred.

The captain also stated that prior to the turbulence encounter, he observed a second Mach speed indication (depicted by an open circle with the speed .728) below the selected flight management computer (FMC) command speed indication (depicted by a solid circle with the speed .82) on the right side primary flight display (PFD) airspeed indicator. He said that the second Mach indication was "usually not displayed," and that he had attempted to correct the secondary indication by momentarily engaging the autopilot speed command and then disengaging the system. However, this action was unsuccessful, so he attempted to correct the airspeed indication with inputs to the FMC through the No. 2 multifunction control display unit (MCDU). This action was also unsuccessful, and the secondary Mach indication remained visible on the airspeed indicator.

The captain also stated that when they experienced the "increase in turbulence," he observed the white "SLAT" light with a down arrow illuminate on the PFD. In addition, he stated that the angle of attack (AOA) bars had changed color on the PFD from cyan to red (indicating a stall condition), the stall warning stick shaker activated, and, at the same time, the "slat overspeed" warning chime sounded. The captain stated that he immediately verified that the flap/slat handle

was in the retracted position by pushing the handle forward,¹ and the flight engineer placed his hand on the flap/slat handle twice to ensure that the handle remained forward in the retracted position.

According to the flight data recorder (FDR) information, the airplane was in a slow right turn (initiated by a change in selected heading) at 296 knots indicated airspeed (KIAS) with the No. 1 autopilot engaged when a slat disagree indication² was recorded (slat position, pressure altitude, roll angle, and other data were not recorded by the FDR because of a prior failure within the airplane's digital flight data acquisition unit; therefore, values of those parameters during the accident flight are not known). The outboard ailerons began to move at this point.³ About 7 seconds after the slat disagree indication was recorded, the airplane began pitching nose up despite autopilot-commanded nose-down elevator deflections (the autopilot elevator deflections were not sufficient to counteract the nose-up pitch moment induced by deployment of the slats). Three seconds later, the stall warning system activated while pitching nose up through 7.4 degrees at 296 KIAS and 1.37 G.⁴ One second later, the airplane reached a maximum nose-up pitch attitude of 9.5 degrees, the airspeed decreased to 293 KIAS, and the vertical acceleration peaked at 1.50 G. The airplane then began to pitch nose down.

After a nose-down pitch rate was established, the elevators began moving in the nose-up direction. Approximately 2 seconds later (about 13 seconds after the slat disagree indication), as the nose-down pitch rate was decreasing and vertical acceleration began to increase, the FDR recorded a rapid movement of the elevators in the nose-down and then nose-up directions, followed immediately by deactivation of the stall warning system and disengagement of the No. 1 autopilot. The airplane reached 5.6 degrees nose-down pitch at 286 KIAS and -0.29 G, and then it started to pitch nose up.

¹The inboard slats fully extend approximately 3 seconds after initial flap/slat handle movement, and the outboard slats fully extend approximately 8 seconds thereafter. Once the outboard slat extension cycle has begun, it cannot be interrupted to initiate the retraction cycle or prevent full extension.

²An amber "slat disagree" indication will illuminate any time the flap/slat handle position and the monitored leading edge slat panel positions do not agree within 30 seconds for the retract cycle or 16 seconds for the extend cycle.

³The outboard ailerons are locked out for high speed flight and will only unlock when the wing flaps are extended, the landing gear is down, or the inboard leading edge slats are extended.

⁴"G" refers to a measure of the force on a body undergoing acceleration as a multiple of the force imposed by the acceleration of the Earth's gravity.

The airplane completed a second (during which another stall warning occurred), third (during which the slat disagree indication deactivated), and fourth pitch oscillation over the next 13 seconds. The maximum and minimum pitch attitudes became increasingly nose down during the oscillations, reaching a maximum of 24.3-degrees nose down at the bottom of the fourth oscillation. Vertical acceleration oscillated divergently (increasing amplitude) during the second and third pitch oscillations, reaching peak values of +1.53 G and -1.24 G during the third, and then began to converge during the fourth as airspeed increased through 320 KIAS.

After completing the fourth pitch oscillation, nose-up elevator deflection and vertical acceleration began to increase rapidly. The FDR data became unrecoverable at this point for undetermined reasons. The FDR data once again became recoverable approximately 5 seconds later with the airplane pitching nose down through 15 degrees nose down, vertical acceleration decreasing through +2.0 G, and airspeed still increasing through 337 KIAS.

The airplane then began to pull out of its oscillating descent (reported by the crew to have ended at approximately 28,000 feet) with pitch attitude steadily increasing and the pitch and vertical acceleration oscillations damping considerably as a result of smaller (although still oscillating) elevator deflections. An overspeed warning was recorded by the FDR as the airplane was pulling out with airspeed increasing through 348 KIAS. Airspeed peaked at 364 KIAS before beginning to decrease, and the overspeed warning deactivated as the airspeed decreased through 360 KIAS. Pitch attitude stopped increasing at approximately 7 degrees nose up and oscillated between 5 and 8 degrees nose up as it climbed. The No. 2 autopilot was engaged approximately 30 seconds later (94 seconds after the initial slat disagree indication), after which the elevator position, pitch attitude, and vertical acceleration oscillations stopped. The airplane continued its climb and then leveled out (at FL330 according to the crew). The FDR indicates that the airplane maintained stabilized flight during the remainder of the flight to Shemya.

Prior to the accident, the radio operator was providing position reports to the Honolulu Aeronautical Radio Incorporated (ARINC) communication specialist, who, in turn, transmitted the airplane's position to the Oakland Air Route Traffic Control Center (ARTCC).

At 0123, the Honolulu ARINC communications specialist received a request from flight 583 for a deviation to the nearest airport because of an

emergency. One minute later, he reported that the emergency was due to a "sick passenger." At 0125, the radio operator again contacted the Honolulu ARINC and reported that there were injured passengers onboard due to "severe turbulence," and he declared an emergency. Through ARINC, the Oakland ARTCC controller then issued a clearance for flight 583 to divert to Shemya.

The airplane remained airborne for approximately 2 hours after the accident, and the flightcrew dumped fuel en route to reduce the airplane's landing weight. At 0329, an uneventful instrument landing system (ILS) approach and landing were made on runway 28 at Shemya.

The accident occurred during the hours of darkness at approximately 39 degrees north latitude, and 172 degrees east longitude.

1.2 Injuries to Persons

	<u>Cockpit Crew</u>	<u>Flight Attendants</u>	<u>Passengers</u>	<u>Other</u>	<u>Total</u>
Fatal	0	0	2	0	2
Serious	3	4	53	0	60
Minor	0	0	96	0	96
None	<u>5</u>	<u>8</u>	<u>84</u>	<u>=</u>	<u>97</u>
Total	8	12	235	0	255

The U.S. Air Force, Coast Guard and Navy provided several airplanes to evacuate injured persons to four hospital facilities in Anchorage. The crewmembers and passengers who were not injured remained in Shemya for approximately 30 hours before they were transported to Anchorage by a second China Eastern Airlines MD-11 that was dispatched after the accident.

The crewmembers and passengers released from the Anchorage hospitals joined the uninjured persons on the second China Eastern airplane, and the flight continued to Los Angeles.

1.3 Damage to Aircraft

The airplane sustained extensive cabin interior damage. Douglas Aircraft Company (DAC) reported the cost of repairing the airplane at approximately \$1,500,000.

1.4 Other Damage

No other property damage resulted from this accident.

1.5 Personnel Information

The flightcrew consisted of the captain, the first officer, the flight engineer (also referred to by the airline as the second officer) and the radio operator. There was also a four-person international relief flightcrew and 12 flight attendants.

1.5.1 The Captain

The captain, age 42, holds a Chinese pilot certificate, No. 5100116, equivalent to a U.S. Airline Transport Pilot certificate. He has ratings for the Ilyushin 14, Trident; Airbus A310; A300-600R; and the MD-11. At the time of the accident, he had accumulated approximately 8,535 hours of total flight time, of which 1,341 hours were in the MD-11.

The captain received initial MD-11 training in August 1991, and had successfully accomplished MD-11 recurrent training at DAC in February 1993. The recurrent training included information from the All Operator Bulletins concerning the inadvertent in-flight slat extensions.

1.5.2 The First Officer

The first officer, age 43, holds ratings for the Ilyushin 14; Antonov 24, British Aerospace BAe 146; and the MD-11. At the time of the accident, he had accumulated 9,714 hours of total flight time, of which 199 hours were in the MD-11.

The first officer received initial MD-11 training in December of 1992.

1.5.3 The Flight Engineer

The flight engineer, age 41, holds pilot ratings for the Trident; an Airbus A310; A300-600R; and the MD-11. At the time of the accident, he had accumulated 9,892 hours of total flight time.

The flight engineer received initial MD-11 training in August of 1991.

1.6 Aircraft Information

1.6.1 General

The MD-11 is a wide-body transport airplane, equipped with three high bypass ratio turbofan engines. Portions of the structure and flight control surfaces incorporate composite materials in their construction. The majority of the airplane's systems are automated with manual backup operation provided.

The MD-11 was certificated by the Federal Aviation Administration (FAA) on November 8, 1990. There are currently 100 airplanes in service worldwide with 15 operators.

The airplane's maximum gross weight is 625,500 pounds, and the maximum gross takeoff weight for B-2171 was 618,000 pounds. The airplane was configured with 298 passenger seats. The airplane is capable of carrying between 250 and 410 passengers (depending on seat configuration), and has a range of approximately 7,960 statute miles.

The flight deck is configured for a two-pilot flightcrew and two jumpseats. The airplane is equipped with six cathode ray tube displays, dual flight management systems, and an automatic flight control system (autopilot) with fail-operational capability.

The accident airplane, serial number 48495, fuselage number 461, is one of five MD-11s that was delivered new to China Eastern Airlines. The airline operates the MD-11 with a four-person flightcrew, consisting of the captain, the first officer, the flight engineer (second officer) and the radio operator (third officer).

The calculated takeoff weight for the departure from Shanghai was 591,416 pounds, and the center of gravity (CG) was at 22 percent mean

aerodynamic chord (MAC). The approximate weight of the airplane at the time of the accident was 495,000 pounds.

As of April 6, 1993, the airplane had accumulated approximately 4,810 total flight hours and 1,571 flight cycles. A review of records indicated that the airplane had not been involved in any previous incidents or accidents.

At the time of the accident, the flap/slat handle on B-2171 had been modified in accordance with all applicable manufacturer's service bulletins (SBs) and FAA airworthiness directives (ADs).

1.6.2 Leading Edge Slat System

The MD-11 has eight leading edge slat segments on each wing. Two of the eight segments are inboard of each wing-mounted engine.

The slats are actuated by a series of cables, hydraulic valves and mechanical linkages that are operated by an integrated flap/slat control handle in the cockpit.

As a requirement to meet FAA certification, the slat input system incorporates an extend bias, which is a combination of slat cable tension and a preloaded spring force, that pulls the flap/slat handle aft toward the slat extend position. The bias was necessary to provide a means of retaining the slats in the extended position in the event of a catastrophic failure in the slat control system. Due to this bias, the handle will move aft if it is not securely held in the selected detent position on the flap/slat handle module.

The flap/slat handle moves a closed-loop control cable system (see figure 1) to operate the inboard slat control valve. The inboard slat control valve supplies hydraulic pressure to two inboard slat actuators. These actuators rotate the inboard cable drive drum to extend or retract the inboard slats. As the inboard slats extend or retract, follow-up cables and mechanical linkages move the outboard slat control valve.

The outboard slat control valve supplies hydraulic pressure to four outboard slat actuators. These actuators rotate the outboard drum to extend or retract the outboard slats. The slats are supplied pressure by two completely

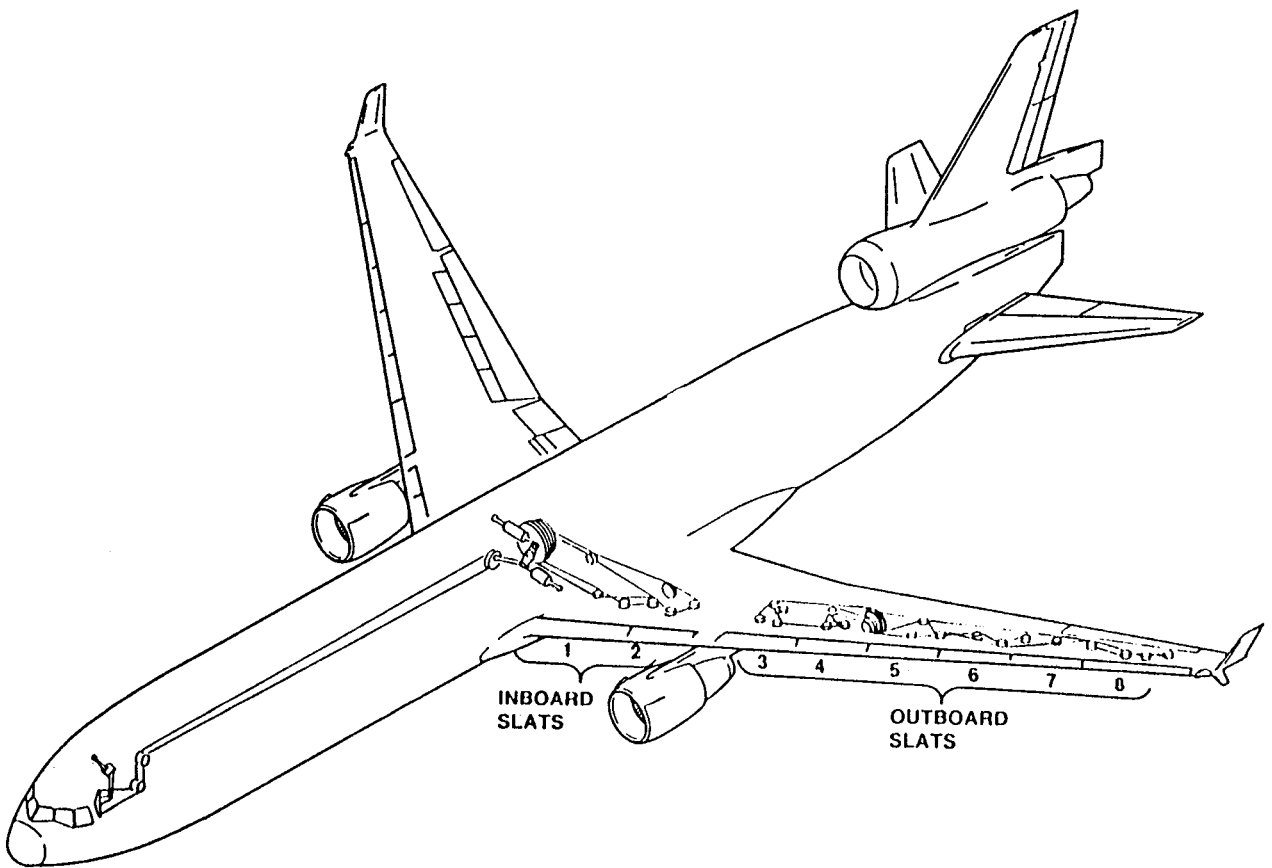

Figure 1.--Slat cable system.

separate and independent hydraulic systems. If one system should fail, the second system will operate the slats.

The time for a normal slat extension cycle is 11 to 13 seconds, and the slat retraction cycle requires 12 to 15 seconds. The slat extension cycle can be interrupted to prevent full extension of the inboard and the outboard slats. The interruption to the cycle will occur if the flap/slat handle is immediately returned to the full forward, retract position within 2 to 3 seconds after the initial aft movement of the handle.

The MD-11 also has an "autoslat" system that will extend the outboard slats automatically if the wing is at a stall angle of attack and all of the following conditions exist: the airspeed decreases below 280 knots or .55 Mach, the flaps are less than 3 degrees, and the slats are not extended.

The autoslat system electrical actuator moves the outboard slat control valve linkage to extend the outboard slats. When the stall condition ceases, the autoslat system retracts the slats. The inboard slats remain stowed during the autoslat extension and will not extend unless commanded by movement of the flap/slat handle. An autoslat extension does not cause the outboard ailerons to unlock.

The position of the slats is detected by proximity sensors located in the left and right wings. The position information is passed through the Proximity Switch Electronic Unit (PSEU) and is processed by the Display Electronic Unit (DEU) for display in the cockpit. Slat position is shown on both the Primary Flight Display (PFD) and the System Display Configuration electronic pages.

1.6.3 Primary Flight Display

The Primary Flight Display (PFD) provides the flightcrew with a variety of information, including flap handle position and flight mode annunciations. Flap and slat indications are shown on the PFD, adjacent to and below the airspeed tape. A white arrow indicates the direction of slat movement (arrow down-extend, arrow up-retract). The "SLAT" indication illuminates amber momentarily during extension, when the slats do not extend symmetrically, or when they require more than 13 seconds to extend. During retraction, the SLAT indication illuminates amber if the slats do not retract symmetrically, or they require more than 30 seconds to retract. (See figures 2 and 3).



FLIGHT CREW OPERATING MANUAL

AIRCRAFT GENERAL - Cockpit Arrangement

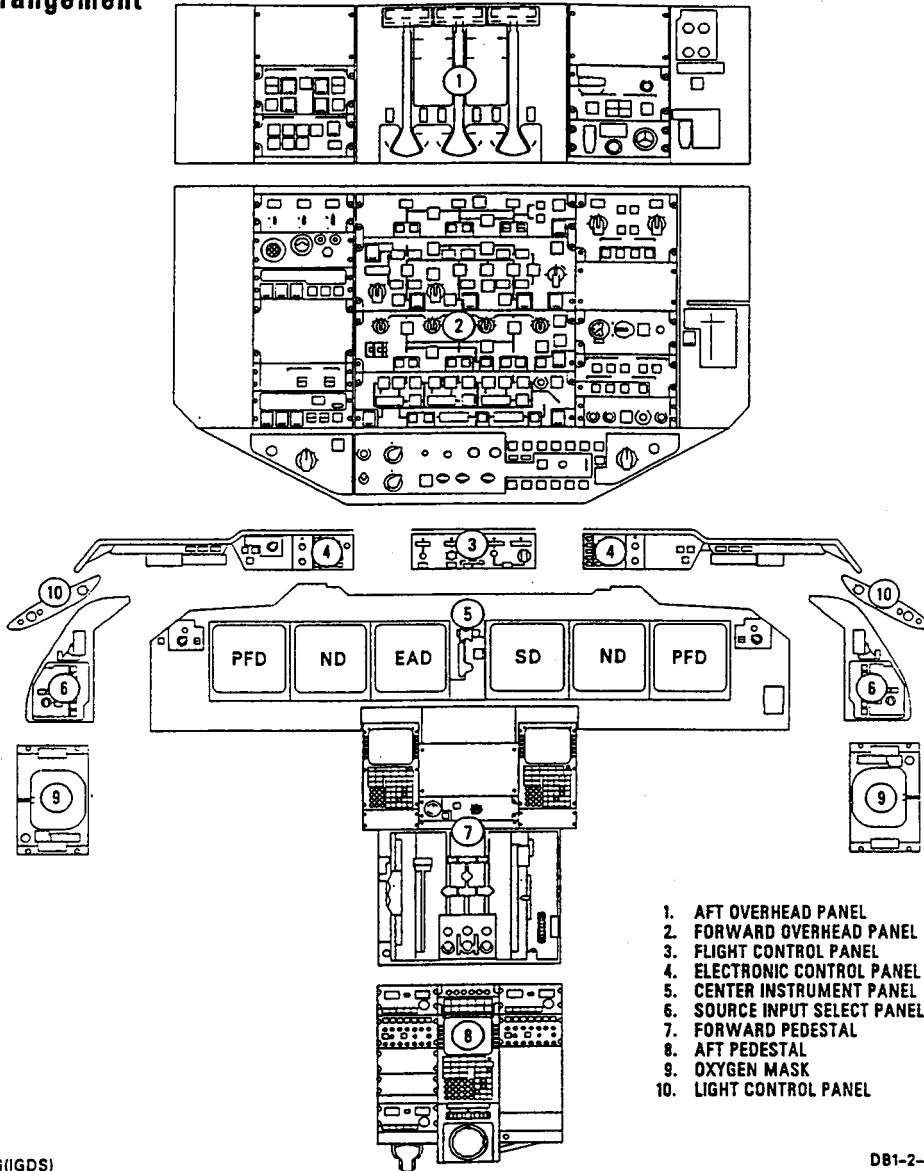

- 1. AFT OVERHEAD PANEL
- 2. FORWARD OVERHEAD PANEL
- 3. FLIGHT CONTROL PANEL
- 4. ELECTRONIC CONTROL PANEL
- 5. CENTER INSTRUMENT PANEL
- 6. SOURCE INPUT SELECT PANEL
- 7. FORWARD PEDESTAL
- 8. AFT PEDESTAL
- 9. OXYGEN MASK
- 10. LIGHT CONTROL PANEL

CAG(IGDS)

DB1-2-318D

01
Feb 1/92

Vol. III
AGEN-11

McDonnell Douglas Corporation Proprietary Information - Use or disclosure of THESE DATA SUBJECT TO RESTRICTIVE LEGEND ON TITLE PAGE OR FIRST PAGE.

Figure 2.--MD-11 cockpit arrangement.



FLIGHT CREW OPERATING MANUAL

AUTOMATIC FLIGHT – Controls and Indicators
Primary Flight Display

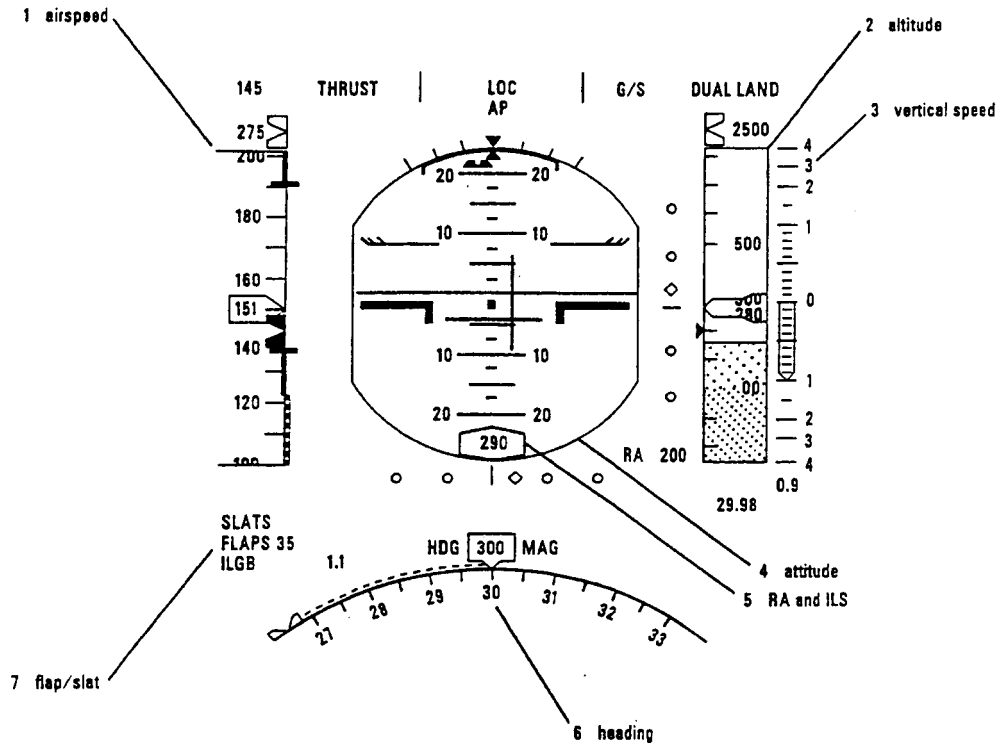

NOTE: The flight mode annunciator (FMA) is the uppermost line of data on the PFD and is presented separately.

CAG(IGDS)

DB1-2-1311A

01
 Mar 1/93

Vol. III
 AUTO-51

McDonnell Douglas Corporation Proprietary Information - Use or disclosure of THESE DATA SUBJECT TO RESTRICTIVE LEGEND ON TITLE PAGE OR FIRST PAGE.

Figure 3.--Primary flight display depicting flap/slat indication.

During the postaccident interview, the captain stated that he observed a white SLAT indication with a down arrow on the PFD, and, shortly thereafter, heard the aural slat overspeed warning. He also stated that neither the master caution warning nor the Engine and Alerts Display (EAD) illuminated.

The airspeed indicator is presented on a vertical scale on the left side of the PFD. Pushing the "FMC SPD" switch arms the FMC speed (typically an economy speed) and cancels any manually selected or preselected indicated airspeed or Mach number. A manually selected airspeed/Mach number is depicted by a white solid circle (bug), and a manually preselected airspeed/Mach number is depicted by a white outlined circle. The FMC commanded airspeed/Mach number is depicted by a solid magenta circle, and an outlined magenta circle will be visible if the FMC speed exists but is not selected. The airspeed/Mach number reference bugs can "park" off the scale, above or below the speed tape, and their digital value will be displayed next to the bug.

1.6.4 Slat Stow Lever

Operation of the flaps and slats is accomplished by a single handle located on the right side of the cockpit center pedestal (see figures 4 and 5). To extend only the slats, the flap/slat handle is moved from the UP/RET detent to the 0/EXT detent. Further aft movement of the flap/slat handle will command the extension of the flaps, up to a maximum of 50 degrees.

To extend the flaps without extending the slats, the flap/slat handle must be positioned in the UP/RET detent. From this position, the handle is then lifted up and moved aft while holding the slat stow lever fully forward. This procedure will disconnect the slat input from the flap/slat handle and leave the slats in the retracted position. Once the flap handle is returned to the UP/RET detent, the slat input will automatically reconnect to the flap/slat handle.

The primary reason for the slat stow lever is to allow operation of the flaps when the slat input system is malfunctioning or failed. With the slats in the retracted or stowed position, the flap handle can be moved without slat input to the system.



FLIGHT CREW OPERATING MANUAL

FLIGHT CONTROLS – Controls and Indicators Flap/Slat System

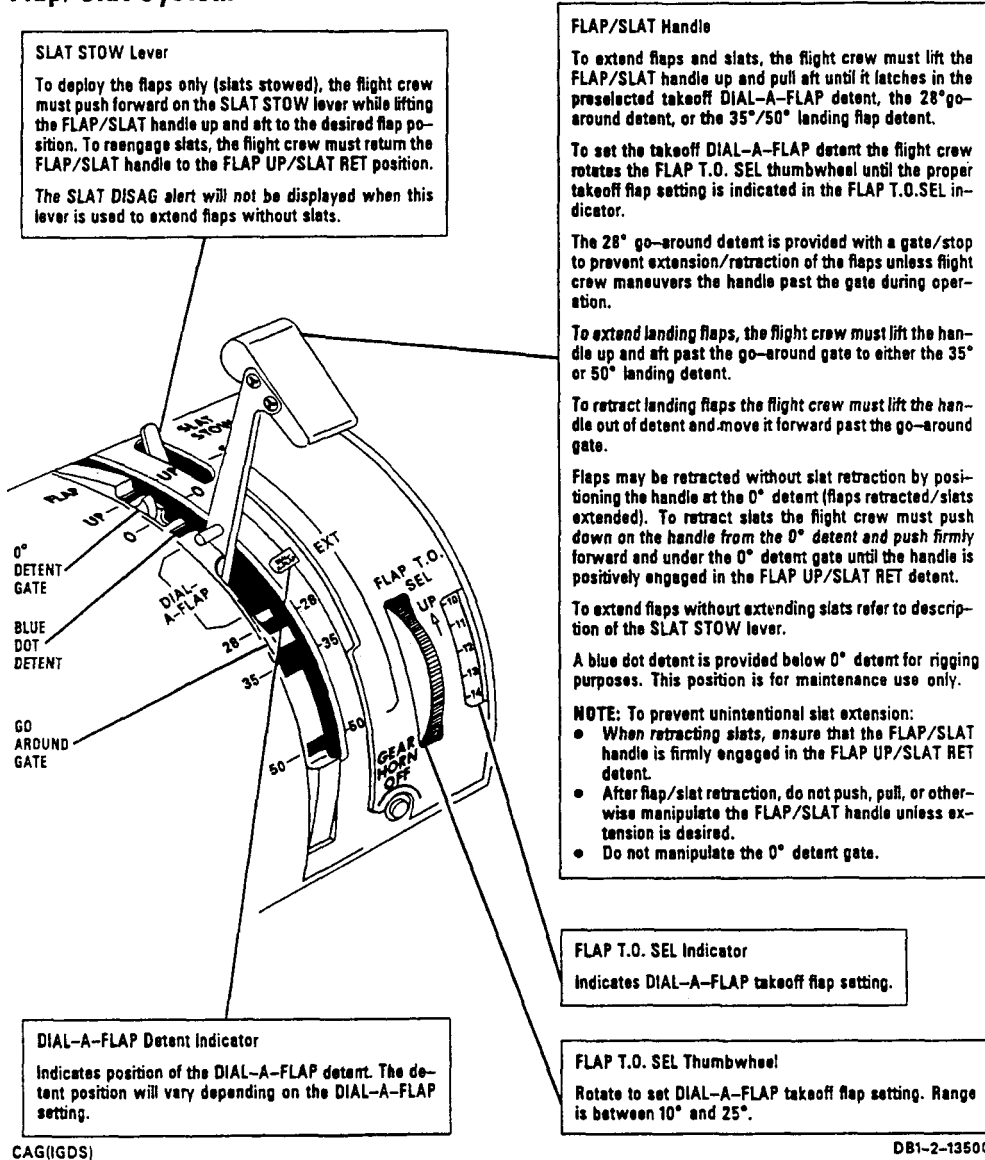

CAG(IGDS)

DB1-2-1350C

01
Aug 1/92

Vol. III
FLT-25

McDonnell Douglas Corporation Proprietary Information - Use or disclosure of THESE DATA SUBJECT TO RESTRICTIVE LEGEND ON TITLE PAGE OR FIRST PAGE.

Figure 4.--Flap/slat handle module.

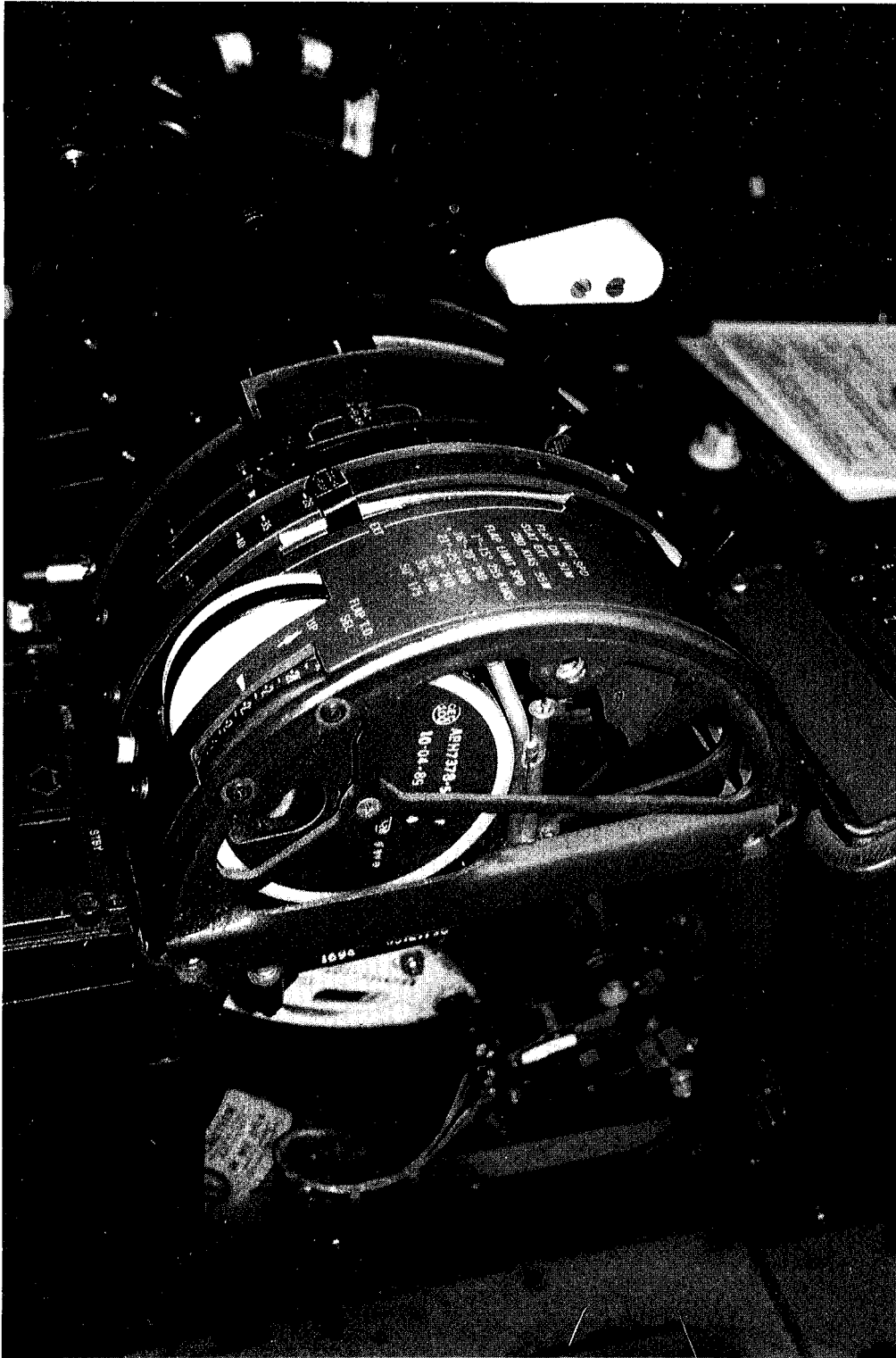

Figure 5.--Closeup view of flap/slat handle in cockpit.

1.6.5 Centralized Fault Display Unit (CFDS)

The CFDS is a fault display system that is connected to the airplane's subsystems and stores detected faults in line replaceable units (LRUs) about such monitored systems as flight controls, navigation, and communications. The fault information is continuously recorded and identified by flight number and the clock time. The faults are retrievable through any one of the three MCDUs in the cockpit.

A review of the aircraft fault data recorded by the CFDS revealed that several system malfunctions or faults had occurred approximately 13 minutes prior to the pitch oscillations. The No. 1 FMC recorded a dual channel failure of the No. 2 FMC. This fault was precipitated by intermittent "ACT failures" of the three Inertial Reference Units (IRU). At the same time, the No. 2 Display Electronics Unit (DEU) recorded a "DEU2/FMC2" bus failure, which would have affected the No. 2 navigation map display. It was determined that these faults would have required a flightcrew member to perform manual inputs through the No. 2 MCDU keypad to restore the navigation data on the No.2 (right side) navigation display. The keypad is located on the right side of the center pedestal, forward and below the flap/slat handle.

1.7 Meteorological Information

According to forecast charts, satellite photographs, and meteorological information, including pilot reports, no evidence of turbulence was forecast or present in the geographical area where the accident occurred. Additionally, the passengers and flight attendants stated that the flight had been "smooth" just prior to the pitch oscillations.

The FDR data were also consistent with flight in undisturbed air.

1.8 Aids to Navigation

Not applicable.

1.9 Communications

The only reported difficulty with communications between the flightcrew and the communication specialists at the Honolulu ARINC was in understanding the China Eastern Airlines' radio operator due to his "very strong

accent." The majority of the communications were relayed through the Honolulu ARINC to the Oakland ARTCC until direct communication was established between flight 583 and the approach controller at Shemya.

1.10 Aerodrome Information

Not applicable.

1.11 Flight Recorders

The airplane was equipped with a Fairchild cockpit voice recorder (CVR), model A100A, that records cockpit area sounds on a continuous-loop 30-minute magnetic tape.

Readout of the CVR was conducted at the Safety Board's laboratory in Washington, D.C., and no information pertinent to the investigation was derived due to a mechanical malfunction.

Examination of the CVR revealed an anomalous "run-on" of the unit after the accident, consistent with the continuous-loop tape not being erased prior to recording new audio information. Consequently, the audio tape contained several superimposed recordings, none of which could be associated with the accident.

A test of the CVR was conducted in the Safety Board's laboratory using a newly installed tape and the presentation of audio information to each of the four channels. The CVR recorded the information correctly, but the old audio information was not erased prior to recording the new audio signals. The playback quality of each preceding recording progressively degraded as the tape continued on the endless-loop cycle.

The CVR was further examined, and a functional analysis was conducted by Loral Data Systems, the manufacturer of the unit. The Loral report stated, in part, the following:

...previous recording of a 600 Hz tone was attenuated by only 10 decibels (dB) to 30 percent, and there was no current (65 Hz) through the erase head. There was 65 Hz bias voltage on the record head of 6.9V, which is normal...capacitor C4 on the Bias Generator Card had opened internally [failed capacitor]....

...this is the first time that such a defect has been observed or reported...in over 20,000 CVR units. The fault detection circuit of the A100 was not designed to, nor was it required to detect such partial failures....

Due to the type of failure and the design of the fault detection circuit, it would not have been possible for either the flightcrew or maintenance personnel to detect this malfunction during a preflight inspection or routine maintenance.

The airplane was equipped with a Fairchild flight data recorder (FDR), model F800, that recorded data in a digital format on a 25-hour continuous magnetic tape, and was capable of recording in excess of 250 parameters. The recorder was read out at the Safety Board's laboratory in Washington, D.C.

Examination of the FDR data revealed that the pressure altitude, roll angle, total air temperature and slat position (for all slats) data became anomalous approximately 12 hours of FDR time prior to the accident. Subsequent examination of the recorder determined that the digital flight data acquisition unit on the airplane had malfunctioned,⁵ resulting in anomalous parameter values.

1.12 Wreckage and Impact Information

1.12.1 External Damage Description

An examination of the airplane structure was conducted at Shemya prior to the ferry flight to Los Angeles International Airport to remove cargo and baggage. No external damage was found, and the airplane was released for flight. The airplane was then ferried to the Douglas Aircraft Company facility at Long Beach, California, for further examination, testing and repairs.

Three previous in-flight incidents involving MD-11 airplanes revealed damage to the composite elevators following a stall buffet. Because of these incidents, a detailed examination of the elevators was conducted on B-2171. The "coin tap"⁶ inspection method that was performed on the upper and lower skin surfaces revealed no evidence of delamination or disbonding of the composite

⁵Refer to Section 1.12.2.2 for additional information.

⁶An audible method of testing composite structures for evidence of delamination or disbonding by using a hard object, such as a coin, and noting changes in sound.

surfaces. Wrinkles were found on the left outboard section of the elevator upper skin surface; however, there was no internal structural damage between the wrinkles. Further examination of the wrinkles revealed that they were a normal condition of the composite skin and not the result of in-flight damage.

A nondestructive inspection (NDI) of the elevators, using pulse echo ultrasound ("A" scan), revealed no evidence of internal structural damage.

1.12.2 Aircraft Systems Examinations

The airplane's systems were examined at Shemya prior to the ferry flight to Los Angeles. The cockpit instrumentation, switch positions, and other operational information were not documented due to the fact that the airplane had been flown for approximately 2 hours after the accident and a normal shutdown was performed after the landing at Shemya.

1.12.2.1 Mechanical Systems

Examination of the cockpit control pedestal and flap/slat handle revealed a black rubber plug (used for slat system rigging) in the "blue dot" maintenance rigging detent. The Douglas Aircraft Company engineers stated that the rig detent, which is used for rigging the slat control system, should remain open (no plug) after maintenance. However, the presence of the plug in the detent did not affect the operation of the slat system on this airplane.

The flap/slat handle was found to operate normally through its range of movement. Examination of the slat stow lever revealed that when the lever was pushed forward (the disconnect position), then released, the lever did not return to its normal position.⁷ The lever was operationally tested several times, and it was determined that it could not be manipulated in such a manner that would cause or permit an uncommanded slat extension.

The slat rigging was found to be within approved operational limits. The hydraulic slat actuation system was functionally tested, both on the ground and in flight, and all hydromechanical systems operated normally. The electronic slat indication system was also functionally tested and performed normally.

⁷See Section 1.6.4 for additional information.

All slat-related control valves and inter-related systems were examined, functionally tested and found normal. The flap/slat handle module was examined and found to be operational within design limits, with the exception of the slat stow lever. The installation, normal and autoslat extension systems were also found to be correct and capable of normal operations.

1.12.2.2 Electrical/Electronic Systems

The slat related electrical/electronic systems were examined to determine if the outboard slat electric actuator could have "back-driven" the inboard slat drum. However, the basic design of the system does not incorporate an interconnect between the outboard slat electric actuator and the inboard slat system, thus precluding back driving of the slat drum. The correct installation of the slat system was verified, and the autoslat "return-to-service" checks were accomplished with no anomalies noted. The proximity switch electronics unit (PSEU) also passed a fault check with no anomalies.

The Digital Flight Data Acquisition Unit (DFDAU) was examined to determine why missing parameters and synchronization losses of recorded data occurred during the accident flight.

The discrepancies were determined to have resulted from a failed Programmable Read-Only Memory (PROM) in the DFDAU. Although the DFDAU initially passed a test program during the examination of the unit on the airplane, further examination determined that the unit had malfunctioned. The failure of the DFDAU would not have affected the operation of the inboard slats.

The quick access recorder (QAR) on the airplane was an "after market" installation by China Eastern Airlines. The unit records information on a noncontinuous magnetic tape from various airplane systems that the operator uses for trend monitoring of the fleet and maintenance. The QAR system was queried to determine if any information had been recorded during the accident flight; however, no data had been recorded because the tape had run its full length before the accident event.

1.12.2.3 Hydraulic Systems

The hydraulic system was examined with regard to the effects of a failure of the slat control valve. Had a failure or malfunction occurred, the following would have resulted:

- (1) If the slat control valve crank had failed, the valve would have reverted to a neutral position. Considering a "worst case internal leakage" condition, the slats would extend; however, the cycle time would be approximately 8 minutes. The valve crank was examined and operationally tested with no anomalies found.
- (2) An internal failure of a land in the slat control valve could have ported hydraulic pressure and extended the slats. Also, a pressure surge in the return or supply lines could have resulted in a pressure imbalance in the valve. The valve was functionally tested on the airplane and a test stand, and no anomalies were found. It was also determined that because the valve is pressure balanced, a surge in either the return or supply lines would not change the valve position.
- (3) Slat control valve actuation without slat handle movement was considered. Examination of the valve installation and functionality, combined with ground and flight test results, revealed that the slat control valve operated normally.

1.12.3 Interior Damage Description

The airplane was configured for a four-person flightcrew in the cockpit and 14 flight attendant seats throughout the passenger cabin. There was no damage to any of the flightcrew or flight attendant seats or seat restraint systems.

The passenger cabin was configured for 46 business and 294 coach class seats. (See figure 6).

Cabin Configuration
 MD-11 China Eastern Airlines

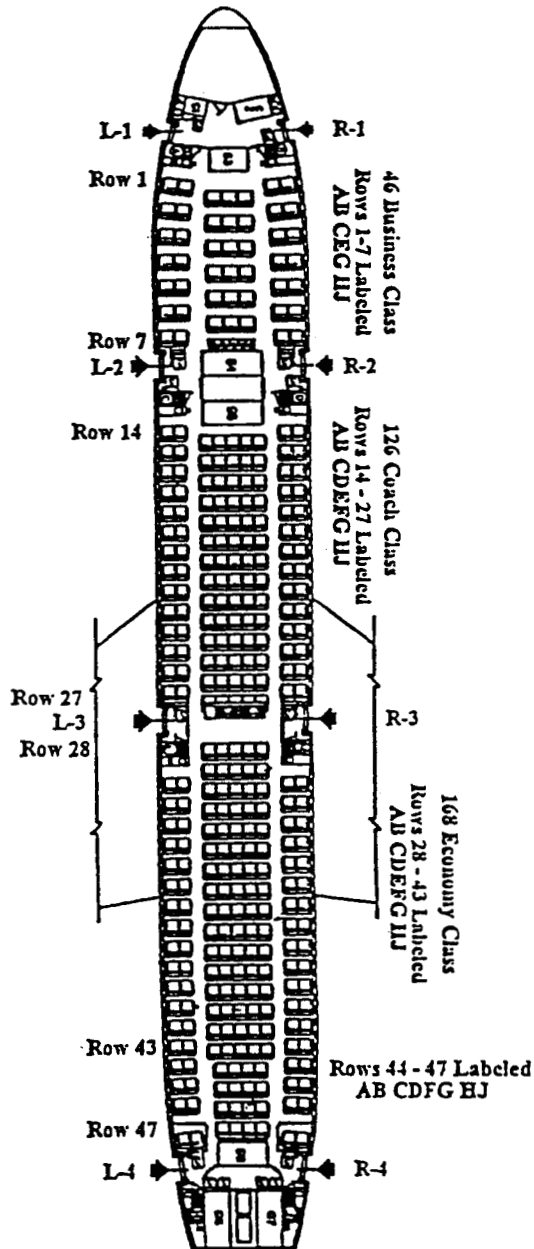

Figure 6.--Passenger cabin configuration.

The primary damage occurred to the interior structure and seats in the coach class section. The damage to the passenger seats ranged from slight deformation to distortion and/or complete collapse of the seat arm rests and seat backs. (See figure 7).

Several passenger service units (PSUs) in the coach class section sustained impact damage when they were struck by passengers. The damaged PSUs had been displaced or pushed up into their mounting structure. Twenty oxygen masks, in various parts of this cabin section, were found deployed as a result of damage to the PSUs.

Numerous ceiling panels in the forward coach cabin and all of the ceiling panels in the aft cabin of the coach section were damaged, and some were displaced upward against their support frames. About 80 percent of the ceiling cross beams, which support the ceiling panels in the aft section of the airplane, were found crimped, separated or bent.

There were 12 video monitors installed above the two aisles throughout the passenger cabin. Each monitor weighed approximately 42 pounds and was suspended from the ceiling with vertical and longitudinal support tubes. None of the 12 video monitors were damaged. However, seven of the monitors, located in the mid and aft cabins, had bent vertical and longitudinal support tubes, and rod ends were found separated from their respective support tubes. The damage to the support structure for these seven monitors was the result of upward impact forces which exceeded the design limits.

There were several first aid kits found on the airplane. One kit was found empty, stowed in an aft overhead stowage bin. A second kit, also found empty, was on the floor near the 4-left flight attendant jumpseat. The used contents of the medical kits were found in the cabin during the postaccident examination.

1.13 Medical and Pathological Information

One male passenger succumbed to fatal injuries before the airplane landed at Shemya, and a second male passenger died in an Anchorage hospital 1 week after the accident. Both passengers had sustained severe head injuries. A total of 149 passengers received injuries, ranging from minor abrasions and contusions to spinal fractures, rib fractures and life threatening head injuries,



Figure 7.--Passenger cabin interior.

including one passenger who was paralyzed. The most serious injuries occurred to unrestrained passengers who were located in the aft cabin.

Three flight crewmembers and four flight attendants also received serious injuries, including one flight attendant who sustained severe brain damage.

1.14 Fire

There was no fire.

1.15 Survival Aspects

The circumstances that precipitated the pitch oscillations were such that a prewarning to the flight attendants and passengers was not possible. Thus, it was those persons, who were unrestrained in the mid and aft cabin, who received the majority of the serious injuries.

According to some flight attendants and passengers, the "fasten seat belt" sign was not on prior to the onset of the pitch oscillations, but it did illuminate during the second oscillation.

Shortly after the pitch oscillations began, flight attendant No. 5, who was assigned to the forward left cabin door (2L), "rushed forward to catch the microphone, but she was heavily pressed against the floor." At the same time, two flight attendants in the front cabin and a flight attendant in the rear cabin instinctively shouted, "turbulence fasten seat belt." Flight attendant No. 5 then made an announcement over the public address system, "turbulence occurred due to unsteady airflow, please fasten your seat belts and do not use washrooms."

Passengers reported that it was difficult to hear the public address announcements during the normal portion of the flight and that following the upset, it was "impossible" to hear the announcements. Also, after the upset, the predeparture safety demonstration video, without audio, was shown approximately three times. However, according to a passenger, "everyone ignored it as they usually do." During the postaccident examination of the cabin, two portable megaphones that were operational were found stowed in the overhead bins above seats 1A and B and 47A and B.

Passengers described the pitch oscillations as a series of 2 or 3 cycles in which unrestrained passengers were alternately lifted to the ceiling and dropped to the floor, or aisle, or into seats other than those they had originally occupied. Passengers also reported striking the ceiling, armrests, seats, and/or other passengers during the oscillations.

Several overhead storage bins in the mid and aft cabins opened during the upset. A passenger, seated in 18B, stated that one of the overhead bins that opened had been "stuffed" before departure and that the flight attendant "had to pound on the bin's door with her fist" to close and secure the bin. Other passengers said that luggage fell from overhead storage bins in the mid and aft cabins during the upset, striking several people.

Two passengers reported that flight attendants provided them with oxygen following the upset. A third passenger, who also received oxygen, stated that the two oxygen bottles given to him by a flight attendant did not operate properly and that a third oxygen bottle was empty. Another passenger expressed concern that several passengers were smoking while oxygen was being administered. Several passengers reported that a Chinese physician assisted injured persons following the upset.

Examination of the passenger cabin at Shemya after the accident revealed provisions for 16 portable oxygen bottles.⁸ Two of the bottles were stowed in the overhead bin at row 1A and B and were found fully charged. A third bottle, found unsecured in the stowage compartment under the flight attendant seat at the 4-left door, held a charge of 1,200 pounds per square inch. Nine bottles were found stowed empty. It could not be determined whether the required number of oxygen bottles was on the airplane at the time of the accident.

According to the China Eastern Airlines Flight Attendants' Work Manual, the following are procedures on announcements regarding the use of seat belts:

1. Before takeoff and landing, flight attendants should inspect and supervise the seat belt fastening of all passengers. After

⁸ According to Douglas Aircraft Company records, B-2171 was delivered with 22 oxygen bottles: 1 bottle in the cockpit, and 21 bottles in the passenger cabin.

that, the flight attendants themselves should be seated with fastened seat belts.

2. In turbulence during flight, flight attendants should inspect and supervise the seat belt fastening of all passengers. After that, the flight attendants themselves should be seated with fastened seat belts.
3. In flight during night, flight attendants should advise the passengers who are going to sleep to fasten their belts.
4. In emergency descending, both passengers and flight attendants should fasten their seat belts.

Examination of the passenger seats on the airplane revealed placards attached to each seat that were written in both English and Chinese and stated: "Please Fasten Seat Belt While Seated." Additionally, seatbelt signs and "No Smoking" signs were located above every seat row.

China Eastern Airlines requires its flight attendants to make several announcements regarding seat belts during the course of each flight. The following announcements occur during the boarding process, while the flight is en route, and prior to landing:

Welcome Announcement: At this time would you please make sure that your seat belt is securely fastened and refrain from smoking until the sign goes off.

In-flight Announcement: To ensure a good rest for every passenger on this long journey, we will be dimming the cabin lights....May we remind you to keep the seat belts fastened as a precaution against sudden turbulence.

Prelanding Safety Check: Please fasten your seat belts and refrain from smoking, and please return your seat back and your tray table to the upright position. Meanwhile, would you mind not walking about the cabin.

Although the flight attendants work manual requires that these announcements be made during the course of the flight, it could not be determined if the "In-flight Announcement" and the "Prelanding Safety Check" had been performed. Passengers reported that they had been instructed to fasten their seatbelts before takeoff.

1.16 Tests and Research

1.16.1 Flight Test

On April 19, 1993, DAC test pilots and flight engineers conducted a flight test with the China Eastern airplane (B-2171) to determine if any anomalies existed with the airplane, especially the leading edge slat system, in flight that would or could not be detected on the ground. The in-flight tests were also intended to evaluate the possible adverse effect that "cold soaking"⁹ of the airplane might have on the slat system.

The airplane was equipped with video cameras, an optical disc recorder, calibrated, hand-operated measuring instruments, and a hand-held video camera to record the slat system operation, pilot actions in the cockpit and electronic system operations and displays.

The test flight was conducted during daylight hours in visual meteorological conditions. The airplane was ferried from Long Beach to Yuma, Arizona, where it was weighed, refueled and ballasted to the test configuration. The airplane's weight and center of gravity (CG) at the time of the accident were calculated to be approximately 495,000 pounds at 31 to 32 percent mean aerodynamic chord (MAC). These weights and balances were determined using nominal fuel system control functions derived from the accident flight. The test flight began with an airplane takeoff weight of 496,120 pounds at 27 percent MAC. A nonstandard fuel burn was used to reduce the weight and move the CG to approximately 30 percent MAC.

The 3-hour and 35-minute flight test was conducted over the Pacific Ocean, off the coast of Mexico, at various altitudes and ambient temperatures.

⁹"Cold soaking" is a term used to indicate that an object has been in a cold temperature long enough for its temperature to drop to or near the ambient temperature.

All slat functional tests were completed with satisfactory results. Slat extension and retraction cycle times were recorded and found to be within DAC production specifications. During the slat extension/retraction cycles, the autopilot remained engaged and properly controlled the pitch axis. No unusual maneuvers or extreme attitude changes occurred.

The airplane was flown at an altitude of FL330 for approximately 2 hours to cold soak the structure. The skin temperature was stabilized at 0 degrees Fahrenheit (standard air temperature of -54 degrees Centigrade). The airplane was then descended to 23,600 feet and stabilized at an airspeed of 229 knots (0.53 Mach). The slat cable tensions were measured and ranged between 6 and 8 pounds, which is within the design criteria for cold soak temperature compensation. Further analysis indicated that low cable tension would not affect the operation or function of the slat control valve.

In all tests, including the cold soak tests, when the slats were commanded to retract, the slat valve input crank remained firmly against the retract stop, which is the normal retract position.

Several slat extensions were performed to evaluate the "feel" of the flap/slat handle. The forces required to move the handle through the various flap/slat settings were considered to be "normal" by the test pilots. The forces (vertical lift required to exit detent) were measured using a spring scale prior to the airplane being cold soaked. These measurements were performed while the airplane was at an altitude of 10,000 feet and at an airspeed of 234 knots (Mach .50). The average lifting force was 19.5 pounds with "very little scatter." The forces were then measured after the airplane had been cold soaked, and, during three slat actuations, the forces were approximately 18.5 pounds.

The airplane was flown to an altitude of FL200 and stabilized at an airspeed of 239 knots (0.52 Mach). Several attempts were made to dislodge the flap/slat handle from the stowed position by normal crew movements in the cockpit. These movements included striking the handle from the left and right sides by both pilots using normal hand movements and striking forces. It was found that the handle was more susceptible to being dislodged and the slats extending when the handle was struck on the aft left side by the pilot in the left seat. However, the handle was dislodged several times intentionally by the right seat pilot by striking the handle on the right rear corner or by catching the handle knob with a shirt sleeve

cuff while moving his hand to program the No. 2 MCDU or by reaching toward the forward center console area.

The slat control valve was visually observed under varying "G" loads that were applied during turns and level push-over/pull-up maneuvers. These G loads ranged from 0.6 G to 2.0 G. The tests were performed at FL210 at an initial airspeed of 230 KIAS. The results of these tests revealed no evidence of movement by the slat input spring coupler during any of the maneuvers. In addition, normal forces applied to the airframe during the flight test had no adverse effect on the slat control system.

1.16.2 MD-11 Flight Characteristics, Autopilot, and Longitudinal Stability Augmentation System

The MD-11 airplane is designed to obtain improved aerodynamic efficiency by reducing the aerodynamic download on the horizontal stabilizer during the cruise flight regime, thereby reducing the compensating lift necessary from the wing. Reduction in the lift required translates into a reduction in drag, which, in turn, results in improved, specific fuel consumption.

The reduction in the aerodynamic download on the horizontal stabilizer is achieved by operating the airplane at an aft CG maintained by carrying fuel in cells built into the horizontal stabilizer. The lower aerodynamic load requirements permit the stabilizer to be smaller in size, which further reduces aerodynamic drag.

This improved aerodynamic efficiency, as it relates to performance, affects the airplane's longitudinal stability characteristics; that is, the tendency of the airplane to resist pitch disturbances and to return to equilibrium when subjected to a disturbance. The variations in aerodynamic loads on the horizontal stabilizer that occur coincident with a pitch disturbance are a major factor in the longitudinal stability characteristics of an airplane. Thus, because of the aft CG and reduced area of the stabilizer, the MD-11 airplane operates in the cruise regime with less stability margin than some other transport-category airplanes. DAC refers to this as "relaxed stability."

The longitudinal stability characteristics of an airplane are examined during the certification process to demonstrate compliance with FAA requirements. These requirements dictate that the airplane must be both statically and dynamically stable. Static stability is measured as a function of the force required on the control

column as the airplane's speed diverges from the initial trim speed. The "stick force" curve must be such that the force required increases as the trim speed differential increases. The airplane is also required to meet a stick force per load factor requirement, whereby the pilot must apply stick forces to achieve flight load factors.

The dynamic stability is measured as the time that it takes for the airplane to regain equilibrium following a pulse elevator control input without corrective pilot control commands. There are no certification tests or objective measures to specifically assess the airplane's susceptibility to pilot overcontrol or out-of-phase induced pitch oscillations.

During the MD-11 design phase, the DAC engineers intentionally designed the airplane to be flown with minimum positive or even neutral static longitudinal stability. With low static stability, light control column forces could produce severe flight loads. Thus, to make the airplane handling characteristics acceptable to pilots, as well as to ensure compliance with the FAA requirements, the airplane is equipped with a longitudinal stability augmentation system (LSAS). This system provides conventional pitch axis handling characteristics through elevator commands without control column movement. The LSAS is essentially a full-time attitude hold system that uses the elevators to immediately respond to damp externally induced pitch disturbances. Once the pilot's force on the control column exceeds 2 pounds, the LSAS system disengages, resulting in unassisted manual control. When force is removed from the control column, the LSAS reengages, targeting the pitch attitude determined by the sum of the current pitch attitude and 1/2 of the pitch rate.

During the certification flight test program, it was determined that, with the aft CG limit established at 34 percent MAC, the MD-11 had positive static longitudinal stability without the LSAS. However, the control column force to produce a given flight load is less for the MD-11 than for other transport-category airplanes. To enhance the stability characteristics and reduce pilot workload during the cruise regime, the LSAS remains an essential element of the control system.

Normally, during cruise flight, the MD-11 is controlled by the autopilot. The autopilot commands the left inboard elevator to move to achieve a target pitch attitude. The flight computer defines the target pitch attitude required to perform a specific flight maneuver, such as maintaining a constant pitch attitude, altitude, or vertical speed. Movement of the inboard elevator will back drive the

other three elevators through mechanical connections. However, because of compliance in the mechanical connections, the slaved elevators will have less deflection than the elevator driven by the autopilot.

If the pilot attempts to override the autopilot by direct control column force, all of the elevators will move, and the pilot will experience significant resistance. If the autopilot is disconnected while the pilot is exerting force on the control column to counter the autopilot resistance, an abrupt change in the elevator position will be induced by the pilot before he is able to react to the lessening control column load. DAC test pilots state that pilots typically react to this abrupt elevator command by overcorrecting in the opposite direction, with larger than normal control column movement that translates into more elevator deflection than would have been commanded by the autopilot.

1.17 Additional Information

1.17.1 Douglas Flightcrew Training Information

The captain of flight 583 had completed recurrent training approximately one month prior to the accident. The ground school portion of the training included a review and discussion of information regarding the inadvertent or uncommanded in-flight extension of the slats.

Information from the Douglas Interim Operating Procedures (IOP), 2-138A, dated August 31, 1992, was presented and discussed during the captain's recurrent training class. The information contained in this section follows, in part:

Interim procedure to avoid unintentional slat deployment by verifying FLAP/SLAT handle is properly stowed in the FLAP/SLAT RET detent:

To retract the slats, push the FLAP/SLAT handle down firmly to the full forward limit of its travel (i.e. into the FLAP UP/SLAT RET detent). To verify that the FLAP/SLAT handle is in the proper stowed FLAP UP/SLAT RET detent, release the FLAP/SLAT handle and push forward on the SLAT STOW lever to the full limit of its travel.

The full forward travel of the SLAT STOW lever will then move the FLAP/SLAT handle into its correct stowed position.

NOTES:

Some increasing resistance will be encountered when pushing the SLAT STOW lever to its full forward stop....

If an unintentional deployment of the FLAP/SLAT handle and the slats should occur during cruise, the first cockpit indication that the slats are extending is a momentary amber "SLATS" annunciation on the Captain's and First Officer's PFD's, followed by the words "SLATS" and a downward pointing arrow displayed in white. If this occurs the pilot should act promptly, but smoothly, to prevent entering an unusual attitude, and simultaneously return the FLAP/SLAT handle to the FLAP UP/SLAT RET detent to retract the slats. Return to normal flight conditions will not require abrupt or extreme flight control inputs to safely control the aircraft.

1.17.2 Summary of Other Reported In-flight Slat Extensions

The Safety Board is aware of 12 incidents of inadvertent or uncommanded in-flight slat extensions and 2 events on the ground involving MD-11 airplanes. Information concerning these extensions was distributed by DAC via All Operators Letters (AOLs). The following is a synopsis of the in-flight events and the subsequent corrective actions:

1. April 18, 1991, the slats deployed at FL370, at .83 Mach. The flap/slat handle moved aft into lower path. As a result of this event, Douglas issued FO-AOL-11-006, on April 19, 1991, advising MD-11 operators that if the flap/slat handle was not properly positioned, it could make an uncommanded movement out of the slat retract position, resulting in slat extension.
2. July 12, 1991, the slats deployed while the airplane was in cruise at .84 Mach. Reportedly, a clipboard fell on the flap/slat handle. On October 16, 1991, Douglas issued Service Bulletin, 27-18, which recommended the

modification of the "zero degree detent gate," intended to prevent unintentional slat extensions.

3. December 10, 1991, initially reported as severe turbulence; however, it was later learned that the slats had extended as the result of inadvertent flap/slat handle movement. Service Bulletin 27-18 had not been accomplished.
4. December 24, 1991, the airplane entered a prestall buffet at FL310 and .82 Mach. The PFD showed the slats in-transit and the handle was not in the UP/RET detent. Service Bulletin 27-18 had not been accomplished.
5. March 6, 1992, first officer rested his arm on the flap/slat handle as he was operating the No. 2 FMC through the No. 2 MCDU. This action moved the handle down through the lower path, extending the slats. Service Bulletin 27-18 had not been accomplished.
6. April 12, 1992, the slats extended in cruise flight after the pilot pushed down on the zero degree detent gate. This opened the lower path and the flap/slat handle moved aft. Service Bulletin 27-18 had been accomplished; however, Alert Service Bulletin (ASB) 27-30 (zero degree detent gate cover) had not been accomplished.
7. April 27, 1992, pilot reported the flap/slat handle moved and the slats extended. Service Bulletin 27-18 had not been accomplished.

Following a total of nine reported inadvertent slat extensions (seven in-flight and two on the ground), DAC issued FO-AOL-11-046, on May 1, 1992. The AOL updated the information concerning the in-flight slat extensions and noted that in one of the events, the zero degree detent gate modification (SB 27-18) had been performed.

8. June 3, 1992, the slats extended while the airplane was in cruise flight. The flap/slat handle did not move out of the UP/RET detent. The rigging of the slat input system was

found to be out-of-tolerance in three separate locations, all biased toward the extend position.

Following this event, DAC issued an Alert Service Bulletin (ASB), A27-29, which recommended the inspection of the MD-11 fleet to confirm proper slat system rigging. The bulletin also provided the procedure to re-rig out-of-rig airplanes. The FAA issued Airworthiness Directive (AD) T92-14-51, on June 29, 1992, requiring mandatory compliance with the ASB within 10 days.

On June 25, 1992, Douglas issued FO-AOL-11-46A, which recommended an interim procedure to verify the proper flap/slat handle position in flight, until design changes could be made available. The AOL contained the following note:

CAUTION:

Do not depress the FLAP/SLAT handle, or place any object on the center pedestal which may accidentally depress the handle or rest hands or arms on the handle. Once the handle is depressed, the Zero Degree Detent Gate locking mechanism prevents the FLAP/SLAT handle from moving aft and extending the slats. If the Zero Degree Detent Gate is subsequently depressed, a combination of the control cable tension and spring forces will pull the handle aft and extend the slats.

9. June 28, 1992, the slats extended while the airplane was in cruise flight without movement of the flap/slat handle. Slat rigging was found to be out of tolerance during the accomplishment of Service Bulletin 27-29.
10. July 15, 1992, the slats extended in cruise flight after the first officer inadvertently moved the flap/slat handle while reaching for a chart on the forward part of the center pedestal. The handle moved up and out of the UP/RET detent. The extend bias spring pulled the handle aft.

On August 13, 1992, DAC issued FO-AOL-11-046B regarding the July 15, 1992, occurrence of an inadvertent slat extension during cruise flight. The letter also contained the following note:

CAUTION:

The flightcrew should exercise caution in the movement of objects or their hands in a manner which would unintentionally displace the FLAP/SLAT handle in a forward and upward motion. Sharply striking the aft side of the handle will allow the handle to move upward if a very light vertical force is applied. Normal spring and cable tension will move the handle aft once disengaged from the FLAP UP/SLAT RET detent and allow the slats to extend.

On August 20, 1992, Douglas issued ASB 27-30 that provided a protective cover which was installed over the zero degree detent gate of the flap/slat module to prevent manual depression of the gate. The FAA mandated the incorporation of the ASB in AD 92-26-03, on December 23, 1992, which allowed a 60-day compliance period.

The eleventh event was the China Eastern accident. Following this accident, Douglas issued FO-AOL-11-070, on April 28, 1993, providing information about the flight characteristics that a flightcrew could experience during an inadvertent slat extension. The AOL also included recommended actions to be taken by the crew to maintain control of the airplane.

12. July 2, 1993, while cruising at FL350 and .83 Mach, the check airman in the right seat pushed the slat stow lever forward. The handle moved aft and the slats extended completely. The crew disengaged the autopilot and restowed the slats. The airplane lost 1,000 feet of altitude and was manually flown back to FL350.

1.17.3 MD-11 Slat System Service Bulletins

As of June 3, 1993, DAC had issued four service bulletins pertinent to the MD-11 slat system. The following are a summary of those bulletins:

1. SB 27-7 - August 22, 1991

Analysis of the MD-11 slat extend command control cable system determined that the design would result in the uncommanded retraction of the slats in the event the slat

cable was severed. The service bulletin specified an inspection of the slat extend command control cable to determine the service condition of the cable.

The service bulletin also provided for the modification of the cable system by installing a bias spring in the slat system input clapper (spring coupler). The spring biases the slat control valve to the extend position in the event the extend command control cable fails.

Douglas recommended that the cable inspection be performed repetitively at intervals not to exceed 500 hours, until such time that the bias spring was installed. The bias spring was required to be installed one year from the date of the Certificate of Airworthiness.

2. SB 27-18 - November 21, 1991

DAC analysis determined that insufficient latching capability of the flap control module could result in uncommanded movement of the flap handle. The movement of the handle would cause an inadvertent extension of the slats during flight. DAC also determined that a downward force on the handle could open the lower path, thus permitting the handle to move aft through the gate, resulting in an uncommanded extension of the slats.

The SB recommended that the zero degree detent gate in the flap module be modified with a zero degree detent gate to minimize the possibility of an uncommanded slat extension. The SB was mandated by the issuance of FAA Airworthiness Directive 92-13-03.

3. ASB A27-29 - June 26, 1992

DAC issued an ASB that specified an inspection and re-rigging procedure to confirm the proper rigging of the slat control system in the MD-11 fleet. The operators were

requested to submit to DAC the findings of their inspections (both positive and negative).

ASB A27-29 was mandated by AD T92-14-51.

4. ASB A27-30 - August 20, 1992

DAC recommended the installation of a protective cover over the zero degree detent gate of the flap/slat handle. The modification was prompted by an uncommanded extension of the slats when the pilot on an airplane that had been modified per S/B 27-18, depressed the zero degree detent gate while the flap/slat handle was stowed in the retract detent.

The SB was mandated by AD 92-26-03.

1.17.4 Passenger Seat Fire Retardant Conditions

Examination of the seat cushion dress covers in the fore and aft sections of the coach cabin revealed nothing remarkable. However, removal of the dress cover revealed that the fire-blocking material was stained and/or discolored by an unknown substance(s), severely worn, and, in many cases, the material was creased, torn or shredded.

The passenger seats had been manufactured by SICMA Aero-Seat of Paris, France. They were constructed of polyurethane foam cushions (both seat backs and bottoms), and covered by a fire-blocking material which was manufactured by Testori Textiles of Italy, part No. 0200-316. The material was composed of 70 percent Preox (a carbon fiber) and 30 percent Kevlar and Velcro Nomex tape. The dress cover (color-coordinated material) was composed of 95 percent wool and 5 percent nylon thread.

Flammability tests of a seat back and bottom cushion from the accident airplane and a passenger seat from an Aerospatiale ATR-42, complete with the dress covers, were conducted at the FAA's Technical Center in Atlantic City, New

Jersey. The tests were conducted in accordance with 14 CFR Part 25,¹⁰ and it was determined that the seat cushions did not meet the standards of this Part because they exceeded the average weight loss of burn length requirements.

Further tests were conducted on three sets of both types of new material (Part Nos. 0206-100 and 0200-316) supplied by SIMCA. The new material also did not meet the standards set forth in Part 25.853 because it exceeded the maximum allowable weight loss of 10 percent. According to FAA Fire Specialists, the certification tests performed on fire-blocking material samples can, in some cases, be inconclusive because the test results can vary due to climatic changes, environmental differences, etc., among the different laboratories performing the tests.

Examination of samples of Testori fire-blocking material removed from a passenger seat on the accident airplane, a flight attendant seat from an Aerospatiale ATR-42, operated by a U.S. airline, and new material supplied by the manufacturer were also conducted at the Du Pont Fibers Laboratory in Wilmington, Delaware.

According to the Du Pont report, the examination of the three fabrics submitted for analysis indicated that the samples taken from the accident airplane and the ATR-42 were constructed of 2-ply spun yarn, and the new material was constructed of continuous filament yarn. Additionally, all three samples were found to have been coated with a lubricating finish, "most likely applied to the fabric to protect the 'brittle' Preox fiber." The report also stated that the lubricant finish also might have affected the flammability of the fabric.

The "new" seat dress cover upholstery and fire-blocking material were tested for durability at the Weber Aircraft facility in Gainesville, Texas. The tests

¹⁰ Appendix F to 14 Code of Federal Regulations (CFR), Part 25, Test Criteria and Procedures for Showing Compliance with Sec. 25.853, or 25.855, sets forth the test procedures and acceptance criteria for flammability of interior ceiling panels, interior wall panels, floor coverings, seat cushions, and padding. Accordingly, paragraphs 4 and 5, state, in part:

For at least two thirds of the total number of specimen sets tested...the burn [flame] length must not exceed 17 inches...the average percentage weight loss must not exceed 10 percent....

There are no requirements to perform periodic in-service flammability tests of the fire-blocking materials to determine whether they continue to meet the standards of 14 CFR 25.853.

were conducted in accordance with Boeing Specification Support Standard, BSS-7302, using a "Squirming Herman,"¹¹ programmed to simulate a 140-pound person sitting and moving in the seat for 1 year to 2.5 years. Examination of the fire-blocking material from the cushions after removal from the "Squirming Herman" revealed that the fire-blocking material had randomly worn very thin and had discolored from green to yellow. The condition of the material samples after the tests were found to be similar to the material removed from the seats on the accident airplane.

1.17.5 Safety Board Recommendations Subsequent to the Accident

As a result of this accident, on June 29, 1993, the Safety Board issued the following safety recommendations to the Federal Aviation Administration:

A-93-81

Issue an Airworthiness Directive requiring the operators of MD-11s to install an interim flap/slat handle system or device to prevent the inadvertent deployment of the wing leading edge slats, when such a system or device becomes available.

A-93-82

Issue an Air Carrier Operations Bulletin to Principal Operations Inspectors to verify that MD-11 operators have advised flightcrews of the potential for an inadvertent in-flight slat extension if contact is made with the flap/slat handle.

A-93-83

Require an expeditious installation of a redesigned flap/slat actuating system, when it becomes available for retrofit, that will prevent uncommanded and inadvertent deployment of the leading edge wing slats on MD-11 airplanes.

¹¹ An apparatus that is used to cause wear and tear on a seat or seat cushion by simulating a person sitting and seat movement caused by a person.

See Section 4, Recommendations, for the status of these safety recommendations.

2. ANALYSIS

2.1 General

The flightcrew and flight attendants were trained and qualified in accordance with the applicable standards and requirements of the Chinese government and China Eastern Airlines. The captain had received recurrent training at DAC in February 1993 and was familiar with the available All Operator Bulletins (AOLs) regarding the inadvertent extension of the leading edge slats.

The airplane had been properly maintained and equipped with all mechanical flap/slat handle devices specified in the SBs and ADs issued by DAC and the FAA.

There was no damage to the exterior of the airplane, and the structural integrity of the airplane remained intact. The damage to the interior cabin was caused by passengers and objects striking the seats, the overhead storage compartments and passenger service units.

Although the captain believed that the cockpit instrument indications, warnings and extension of the slats were precipitated by turbulence, the FDR data and interviews with passengers and flight attendants indicate that the flight had been "smooth" and that the "fasten seatbelt" sign was not illuminated prior to the upset. Thus, based on evidence gathered from passenger statements, weather analysis, pilot reports (PIREPs) from other aircraft on similar routes of flight shortly before and after the accident, as well as FDR information, the Safety Board concludes that no turbulence existed in the immediate area before and during the accident sequence. In addition, the Safety Board found no reason for the seatbelt sign to have been on. It is most probable that the vibrations, caused by the initiation of the slat extension above the maximum design speed, were perceived as turbulence by the flightcrew.

The Safety Board's analysis of this accident concentrated on the reasons for the inadvertent extension of the wing leading edge slats and the resulting pitch oscillations. This analysis included the review of 10 previous inadvertent slat extensions, the information currently available to operators of the MD-11, interim mechanical devices installed on the flap/slat handle, the design and operation of the flap/slat handle and its inter-related systems, and the pilot's manipulation of the flight controls.

Although the condition of the airplane's seat fire-blocking material was not a factor in the accident, the Safety Board's investigation also concentrated on the reason for the deterioration of the fire-blocking material on the passenger seats and on the certification standards for this material. Also, the Safety Board reviewed the regulations and found several inadequacies regarding the inspection standards and procedures for the airworthiness condition or replacement of this material.

2.2 Inadvertent Slat Extension

2.2.1 Leading Edge Slat System

Assuming the rigging is within tolerance, the inboard slats are mechanically linked to the flap/slat handle and will only extend or retract when the handle is moved in or out of the UP/RET position. The outboard slats are mechanically connected to the inboard slats through a follow-up cable system that operates the slat control valve. The extension of the outboard slats will begin when the inboard slats have extended through approximately half their normal travel.

Upon initial movement of the flap/slat handle out of the UP/RET position, the inboard slats extend in approximately 3 seconds. The extension of the inboard slats can be interrupted within the 3-second period if the flap/slat handle is immediately returned to the UP/RET position. However, if the handle is repositioned after the 3-second period, the inboard slats will begin to retract while the outboard slats continue the extension cycle. The inboard slats will then reach a position to command the outboard slats to retract.

A study of the effects of slat deployment found that the extension of only the inboard slats does not cause a pronounced pitch-up tendency, even at airspeeds that are beyond the normal realm of slat operation. The change in lift is at the center of pressure and has little effect on the pitching moment of the airplane. However, the extension of the outboard slats results in a loss of lift. Since the loss of lift is behind the center of pressure (due to the sweep of the wing), the airplane tends to pitch nose up.

Evidence also indicates that even though the attitude change may be very pronounced when the outboard slats extend, the airplane is controllable with minimum pitch control action by the pilot. Furthermore, large pitch control inputs by the pilot may produce severe and unwanted attitude changes of the airplane.

Because the digital flight data acquisition unit had failed several hours prior to the slats extending, slat command and actual position information was not available for the analysis. However, the FDR information revealed that the left and right outboard ailerons had unlocked during the accident sequence. This unlocking was significant because the outboard ailerons are normally used when the airplane is operating at slow airspeeds and are locked out during cruise flight. The ailerons will only unlock when either the flaps, slats, or the landing gear is extended. The FDR information indicated that the flaps and landing gear were in the up position and that the airplane was in a nose-up pitch attitude when the ailerons unlocked. Thus, the Safety Board views the unlocking of the ailerons, in combination with the pitch perturbation, as evidence of slat extension.

The Safety Board considered the possibility that the slat extension was caused by a valid or an erroneous autoslat extension command. The autoslat system automatically extends the outboard slats when the airplane is in a stall condition and retracts the slats when the condition ceases. However, it was determined that the inboard slats would not have extended by an autoslat command and that the outboard ailerons would not have unlocked as a result of outboard slat movement alone. Additionally, the airspeed, altitude and pitch attitude information from the FDR revealed that the airplane was not at or near a stall condition when the slats first extended.

The Safety Board also analyzed possible mechanical and nonmechanical anomalies that could have affected the operation of the slats. The ground and in-flight examination of the slat system components from the accident airplane revealed that the installation of the slat system was correct. In addition, no evidence was found of a mechanical malfunction or a failure of any component or interrelated system that would have resulted in the slats extending without the flap/slat handle being moved out of the UP/RET position. The investigation did reveal that the flap/slat handle system, even with all applicable modifications installed, could still be inadvertently dislodged by routine flightcrew movements in the cockpit and could cause an uncommanded extension of the slats. The most compelling evidence of flap/slat handle movement was the illumination of the white down arrow, as observed by the pilot on the PFD, and the absence of a master caution warning--a combination that is only compatible with slat motion in response to a handle movement. Thus, the Safety Board views this as conclusive evidence that the flap/slat handle did move out of the UP/RET position, commanding the inboard slats to extend and the outboard ailerons to unlock.

2.3 Flightcrew Performance

2.3.1 Slat Handle Contact

The Safety Board's analysis of the information derived from interviews with the flightcrew and data retrieved from the FDR revealed several possible opportunities for a flight crewmember to have inadvertently contacted the flap/slat handle.

The captain stated that prior to the encounter with turbulence, he had been attempting to resolve a discrepancy with the FMC Mach number on the airspeed indicator. He said that he momentarily disengaged and then reengaged the autoflight speed command system; however, the discrepancy remained. He also made inputs into the FMC through the No. 2 MCDU; however, this action was also unsuccessful. The Safety Board believes that the captain observed the FMC calculated economy speed bug, depicted as an open magenta circle and Mach number, and became concerned by the lower-than-normal value that was shown. This speed is predicated on various information, including a company fuel cost index, and is programmed into the FMC "aircraft initialization" page during preflight. One possible explanation is an inaccurate cost index that may have been entered into the FMC which resulted in a low optimum Mach speed to conduct the flight. The captain may have been confused by the low Mach number relative to the commanded speed of .82 Mach, which had been manually selected and was being flown by the autoflight system (AFS), and attempted to correct the economy speed indication through inputs to the FMC. These inputs would have required a crewmember to use the MCDU keypad to enter the data and could have resulted in inadvertent contact with the slat handle. The keypad is located on the right side of the center pedestal, slightly forward and below the flap/slat handle.

During the flight from Shanghai to Los Angeles, the centralized fault display system (CFDS) recorded several airplane system faults in the No. 2 FMC. A review of the fault messages stored in the CFDS revealed that these discrepancies occurred approximately 13 minutes prior to the accident sequence. The Safety Board believes that the types of faults that occurred would have required the manual reentry of data by a flightcrew member into the No. 2 FMC through the No. 2 MCDU keypad.

Further, the Safety Board believes that the captain, who was in the right seat, would have been the most likely flightcrew member to reenter the data

because of his close proximity to the No. 2 MCDU keypad. Considering the previous history of inadvertent slat extensions and the AOL issued by DAC, emphasizing that the "...flightcrew should exercise caution in the movement of objects or their hands in a manner that would unintentionally displace the flap/slat handle...", it is most likely that the captain inadvertently contacted the handle while moving his hand in the area of the MCDU keypad. Once the handle was displaced from the UP/RET position, the slat extension cycle began and continued without interruption.

At the time the slats began to extend, the attention of the captain, and most likely the first officer, was directed toward the MCDU keypad and the data entry process. The extension of the inboard slats would not have been noticed by the crew initially because it does not significantly affect the airplane's pitch attitude with the autopilot engaged. Also, it is most likely that as the airplane began to pitch upward with the extension of the outboard slats, the autopilot began trying to compensate and apply corrections by deflecting the elevator nose down. However, once the outboard slats extended fully, the flightcrew's attention would have been immediately focused on the reason for the airframe buffet, the nose-up pitch rate, and the stall warning activation.

The captain stated that when he felt the buffeting, he saw the white slat indication on the primary flight display (slat extended symbol) and heard the slat overspeed warning chime. The captain also stated that he took immediate corrective action, which included verifying that the flap/slat handle was securely in the UP/RET position. His second corrective action was to disconnect the autopilot and to manually control the airplane, in an effort to return to the assigned altitude.

2.3.2 Pilot Control During the Upset

In the Safety Board's analysis of the evidence, it became evident that the primary factor in this accident was the cause of the extreme airplane pitch oscillations that resulted in the injuries to the unrestrained occupants. Thus, the Safety Board examined in detail the pilot control during the upset and resulting oscillations, as revealed by the available FDR data.

Shortly before the inadvertent slat extension, the airplane was in a slow right turn at approximately 1 G while the AOA was at about 3 degrees with the autopilot engaged. As the outboard slats deployed, the pitch angle and AOA started to increase. The autopilot began commanding nose-down elevator in an effort to

maintain the nose-down attitude. When the AOA reached about 5 degrees and the vertical acceleration increased to between 1.2 G and 1.3 G, the stall warning system activated. About 2 seconds after the stall warning, the AOA peaked at about 9 degrees.

The peak AOA was followed by a decrease in the pitch angle and AOA during which the elevator nose-down deflection started to lessen. At this point, it is most likely that the pilot began to exert force against the autopilot in the nose-down direction with control column input, and the autopilot disconnected. The pilot commanded slightly more nose-down elevator for 1 second (most likely as a result of the sudden decrease in nose-up stick force that occurred when the autopilot disconnected), and the stall warning system deactivated. When the stall warning system deactivated, the pitch angle was about 0 degrees and decreasing, the AOA was about 2 degrees and decreasing, and the vertical G-load was about 0.2 G and decreasing. After the stall warning system deactivated, the pilot then commanded more nose-up elevator deflection, consistent with the last autopilot elevator command. Within the next 2 seconds, the pitch decreased to 6 degrees nose down, the AOA decreased to about 0 degrees, and the vertical G-load decreased to about -0.3 G. During the pitch "overshoot," the pilot commanded up to 7 degrees of nose-up elevator deflection. As the pitch, AOA, and G-load stabilized and started to move in the positive direction, the pilot reversed the control deflection to more nose-down elevator, apparently targeting a small positive pitch angle. In fact, the airplane peaked at a 2-degree pitch attitude several seconds later.

Once the 2-degree pitch attitude was attained, a pilot would normally increase the elevator deflection slightly to maintain the 2-degree pitch attitude, which the captain started to do. However, as he started to apply nose-up elevator, the AOA began increasing to about 5 degrees, and the stall warning activated again. In response, the captain applied more nose-down elevator. The stall warning system deactivated about 1 second later at an AOA of about 2 degrees, and the captain commanded the elevator deflection from 7 degrees nose down to 5 degrees nose up within the next second. However, when the stall warning system deactivated, the pitch attitude was about 5 degrees nose down and decreasing, and the vertical G was about 0.2 G and decreasing. During the overshoot that occurred within the next 1 to 2 seconds, the pitch attitude reached 10 degrees nose down and the vertical G reached -0.8 G. The FDR data show that corrective elevator control responses were applied coincident with stall warning system activation and deactivation.

The recovery from the negative G condition was most likely hampered by the fact that the pilot was trying to apply light control forces while experiencing the sensations of the extreme G forces. The load factor quickly reversed from -0.8 G to 1.5 G within the next 2 seconds, making it even more difficult to maintain precise airplane control recommended by DAC. This resulted in a third oscillation of 5-degrees AOA for a short period.

The Safety Board believes that throughout the recovery sequence, the captain used more control than desirable or needed (approximately 50 percent of full authority), as a result of the airplane's low stick force characteristics, and that he delayed elevator control responses until the stall warning deactivated. While the captain responded rapidly to the stall warnings with corrective elevator control, earlier response and lesser control inputs would have been more effective in stabilizing the pitch oscillations.

Once the stall warning activated, it stayed on until the AOA had decreased about 3 degrees below the initiation AOA and the normal G-load was about 0.2 G to 0.3 G. Each time the stall warning system deactivated, the pilot made nose-up control inputs in an attempt to restore a nose-up pitch attitude. However, the "overshoot" resulted in AOAs that were 5 to 10 degrees below the AOAs at stall warning activation and the vertical G reached -0.2 G and -0.8 G.

Contributing to the "overshoot" problem is the fact that the MD-11 stall warning system deactivates 1 second after the AOA decreases to the initiation threshold AOA, as a result of a system time delay. DAC has indicated that this 1-second time delay was intentionally designed into the stall warning system to prevent secondary stall warnings that might otherwise be induced by pilots if the stall warning stops exactly at the point where the stall warning conditions numerically cease. This delay appears to have caused the pilot to maintain nose-down elevator commands that much longer, which tended to push the pitch oscillations that much further into the nose-down regime. The pitch oscillations began to damp when the elevator deflections were limited to about 25 percent of total travel, and the resulting AOA fluctuations were less than required to activate the stall warning system. The fact that the pitch oscillations began to damp once the pilot's elevator inputs were reduced indicates that the prior undamped pitch oscillations were to some extent induced by pilot overcontrol.

The Safety Board is aware of five MD-11 incidents in which inadvertent leading edge slat extension resulted in significant overcontrol-related

PIOs [pilot-induced oscillations] during recovery. The Safety Board is also aware of three MD-11 incidents in which a turbulence upset resulted in a PIO during recovery. In all of the cases, the autopilot was engaged at the beginning of the upset, and the stall warning system activated repeatedly through the PIO. Analysis of the cases suggests that the PIOs during recovery from the pitch attitude upsets are, in part, due to excessive and prolonged control movements by the pilot in reaction to the stall warning system activations.

The Safety Board was advised by DAC that the primary reason for the initial stall warning system activation in these high altitude, high speed cases is for protection from aerodynamic buffet. The concern about buffet damage is significant, as demonstrated by the fact that three of the MD-11 inadvertent slat extension/turbulence upsets have resulted in damage to the composite elevators.

The Safety Board is concerned that MD-11 pilots did not receive specific training related to high altitude upsets and stall warnings. The MD-11 is designed to fly with minimal longitudinal stability margin to improve the economic performance of the airplane. The control column forces needed for manually controlling the airplane during normal maneuvers in cruise flight are lighter than those that pilots might have encountered in their past experiences in other model airplanes, and they are considerably lighter than the control forces normally used at lower speeds and altitudes. DAC warns against excessive control inputs at high altitude. However, the DAC recommendation to target a pitch attitude and minimize control commands during a high altitude upset can, in the event of a stall warning, conflict with the pilot's trained response to react to the stall warning. In addition, pilots are not provided information defining the "overshoots" and possible overcontrol-related PIOs that may be encountered when they delay pitch recovery while trying to silence the stall warning.

DAC recommends that the airplane be operated at lower altitudes if high altitude turbulence is encountered in order to increase the stall margin. The DAC recommendation would result in a 1.4 G to 1.5 G stall margin while improving the economic operation of the airplane, a goal of operating at reduced stability. According to DAC, the FAA has no certification requirement for high altitude stall margins while the European Joint Airworthiness Authority requires that airplanes be operated with at least a 1.3-G margin. The Safety Board believes that a greater stall margin would provide the MD-11 with enhanced protection from unsafe pitch oscillations following turbulence and slat deployment-induced pitch upsets. In addition, the number and length of stall warning activations would be limited by the

greater margin, thereby limiting the influence of the stall warning on the pilot during recovery.

Despite the MD-11's structural need for protection from the stall buffet region, the Safety Board is concerned that the margin between the MD-11's normal operating AOA and that at which the stall warning system activates may be insufficient to allow for pilot recovery from unanticipated pitch attitude upsets without activation of the stall warning system. As evidenced by the incidents to date, the MD-11 stall warning system activations may result in or contribute to overcontrol-related PIOs during recovery from unanticipated pitch upsets. Improved MD-11 pilot training and the scheduled redesign of the MD-11 flap/slat actuation system may reduce the number of MD-11 pitch attitude upsets and resulting PIOs. However, the Safety Board believes that the MD-11's longitudinal stability, stall warning margin, stall buffet damage susceptibility, and pilot training must undergo a thorough review to ensure that routine pitch attitude upsets do not result in stall warning system activations, overcontrol-induced oscillations, structural damage, or any other condition that could lead to unsafe flight.

2.4 Analysis of CVR Failure

The CVR provided no useful information for this investigation because the continuous-loop tape was not being erased prior to the recording of new audio information. The erase mechanism did not operate properly because of a failure of the capacitor on the Bias Generator Card that supplies biasing current to the CVR erase head.

The Safety Board's laboratory has not observed a similar failure of a capacitor on a prefabricated printed circuit board, and the CVR manufacturer has also not observed or reported such a failure in more than 20,000 CVR units. Therefore, the Safety Board concluded that a similar failure is unlikely and that no further action is needed at this time.

2.5 History of Inadvertent Slat Extensions

The MD-11 began commercial service in 1991. Since that time, there have been 12 documented inadvertent in-flight slat extensions, including one airplane that has been involved in two inadvertent in-flight slat extensions. This accident was the first one involving occupant injuries and loss of life.

The spring bias in the flap/slat handle was intentionally designed to cause the slats to extend or remain in the extended position in the event of a catastrophic failure of the system. Due to the reoccurrence of inadvertent slat extensions, DAC released four service bulletins addressing the flap/slat handle problem. Each service bulletin recommended a modification to the slat system that was intended to reduce the possibility of extending the slats due to the inadvertent aft movement of the flap/slat handle. Although these modifications have decreased the probability of an uncommanded extension, they have not eliminated the potential for further inadvertent slat extensions due to inadvertent contact with the flap/slat handle. Therefore, the Safety Board supports efforts to redesign the MD-11 slat activation system to eliminate all potential for hazardous high speed slat extension.

2.6 Occupant Seatbelt Usage

Since there was no prewarning of an impending upset, such as turbulent conditions, the majority of the injured passengers and crewmembers were either seated with unfastened seatbelts or were standing in the aisles in the aft section of the airplane. During the pitch oscillations, some of these people were thrown upward and downward from their seats several times, striking the overhead ceiling panels, overhead compartments, seatbacks, armrests, and/or other passengers. The severity of their injuries was the result of "G" forces that occurred during the sudden and extreme attitude changes of the airplane during the oscillations.

Procedures of China Eastern Airlines require that flight attendants instruct passengers to "keep seatbelts fastened as a precaution against sudden turbulence." However, these instructions are given to passengers when the lights are dimmed in the cabin for the "rest" period. The Safety Board believes that an announcement about the use of seatbelts should be made early in the flight when the seatbelt sign is first turned off. When the accident occurred, the seatbelt sign was not illuminated. Accordingly, many of the passengers apparently did not believe that they needed to have their seatbelts fastened. The Safety Board understands that all passengers cannot be expected to remain seated throughout a flight, especially a transpacific flight. However, the number and severity of injuries could have been significantly reduced if the passengers had been instructed by either the flightcrew or flight attendants to keep their seatbelts fastened at all times while they were seated.

2.7 Passenger Seat Fire Protection

The fire-blocking material under the dress covers of the passenger seat cushions had deteriorated to an extent that the material no longer provided fire protection of the seat cushions. The investigation revealed that samples of fire-blocking material removed from the accident airplane, an ATR-42 that is currently being flown by a U.S. air carrier, as well as a new sample of the fire-blocking material, supplied by the manufacturer, failed to meet the standards set forth in 14 CFR, Part 25.853. Additionally, the material degraded under both normal usage (in 2 years on the accident airplane) and simulated wear and tear conditions that equated to 2 years in service. Based on the findings of the postaccident testing of this fire-blocking material, the Safety Board believes that all transport-category aircraft manufactured or operating in the United States that have seat cushions covered with Testori-manufactured fire-blocking material may not meet the airworthiness requirements of 14 CFR 121.312 and 14 CFR 25. Consequently, the FAA should develop a requirement for verifying the integrity of the material. If the material is found to be defective, it should be removed from service.

To ensure that in-service fire-blocking materials remain in compliance with Federal Aviation Regulations, the Safety Board believes that the FAA should conduct research to determine how in-service wear can degrade the ability of a material to retard flame propagation and should require periodic burn tests of samples of in-service materials to determine their continued compliance with the regulations.

Furthermore, the FAA should inform operators of the need to periodically inspect fire-blocking materials for wear and damage and to replace unserviceable materials. Finally, the Safety Board believes that 14 CFR 25.853 should, in addition to current burn tests of fire-blocking materials, require burn tests of like materials that have been subject to wear that simulates in-service wear. This later test would serve to establish a service life of the material.

The Safety Board found that the fire-blocking material manufactured by Testori is currently being used on thousands of aircraft seats in the commercial aircraft fleet around the world. In the United States, the FAA has established definitive fire-retardant standards for seats used on commercial aircraft. However, Annex 8, of the ICAO International Standards, Airworthiness of Aircraft, does not set forth any uniform standards or recommended inspections/practices. The Safety

Board believes that the FAA should inform other certification authorities about the need for monitoring the airworthiness of the fire-retardant properties of the seats that are used on airliners worldwide.

3. CONCLUSIONS

3.1 Findings

1. The flight crewmembers and flight attendants were trained and qualified for the flight.
2. The captain had recently completed recurrent training and was aware of all available information regarding the inadvertent slat extensions.
3. The airplane was maintained and equipped with all mechanical flap/slat devices specified by the Douglas Aircraft Company and the FAA.
4. There was no evidence of preexisting structural failure or engine faults that contributed to the accident.
5. The flap/slat handle system design and operation was found to be deficient.
6. There was no evidence of turbulence that contributed to the accident.
7. An inadvertent movement of the flap/slat handle most likely occurred during the restoration of data in the No. 2 flight management computer through the No. 2 multifunction control display unit keypad.
8. The extension of the leading edge slats resulted in the airplane pitching up while the autopilot was engaged. The captain took corrective action and thereby replaced the flap/slat handle in the UP/RET position.
9. The captain's initial reaction to counter the pitchup was to exert forward control column force; and the control force when the autopilot disconnected resulted in an abrupt aircraft nose-down elevator command. The captain's subsequent commanded elevator movements to correct the pitch attitude induced several

violent pitch oscillations that resulted in the passengers and flightcrew members experiencing severe positive and negative G-forces.

10. The captain's commanded elevator movements were greater than desirable because of the airplane's light control force characteristics and were in response to the observed pitch attitude and the activation/deactivation of the airplane's stall warning system.
11. The oscillations resulted in a loss of 5,000 feet of altitude. The maximum nose-down pitch attitude was 24.3 degrees, and the maximum normal accelerations were 2.06G and -1.24G.
12. At the time of the accident, the majority of the crewmembers and passengers in the aft section of the airplane were either seated without their seatbelts fastened, with their seatbelts loosely fastened, or they were standing in the aisle.
13. No in-flight announcements were required by the flightcrew or flight attendants to instruct the passengers to keep their seatbelts tightly fastened while seated after the seatbelt signs had been turned off.
14. The combination of violent pitch oscillations and unrestrained cabin occupants led to multiple severe injuries, including two fatalities.
15. The fire-retardant material used on the passenger seats had deteriorated and no longer provided fire protection to the seat cushions. Although this deficiency did not directly compromise the safety of the passengers in this accident, it could potentially jeopardize the safety of passengers in accidents that result in interior cabin fires.

3.2 Probable Cause

The National Transportation Safety Board determines that the probable cause of this accident was the inadequate design of the flap/slat actuation handle by the Douglas Aircraft Company that allowed the handle to be easily and inadvertently dislodged from the UP/RET position, thereby causing extension of the leading edge slats during cruise flight. The captain's attempt to recover from the slat extension, given the reduced longitudinal stability and the associated light control force characteristics of the MD-11 in cruise flight, led to several violent pitch oscillations.

Contributing to the violence of the pitch oscillations was the lack of specific MD-11 pilot training in recovery from high altitude upsets, and the influence of the stall warning system on the captain's control responses. Contributing to the severity of the injuries was the lack of seat restraint usage by the occupants.

4. RECOMMENDATIONS

As a result of the investigation of this accident, the Safety Board makes the following safety recommendations:

--to the Federal Aviation Administration:

Require Douglas Aircraft Company to provide data needed to upgrade MD-11 training simulators to accurately represent the aircraft's longitudinal stability and control characteristics for high altitude cruise flight; and to develop specific guidance and simulator scenarios to train pilots in optimum techniques for the recovery from high altitude upsets, including those accompanied by stall warning. (Class II, Priority Action) (A-93-143)

Require operators to provide specific training for the recovery from high altitude upsets, including those accompanied by stall warning. (Class II, Priority Action) (A-93-144)

Establish high altitude stall margins for MD-11 airplanes in order to limit the effects of high altitude pitch upsets. (Class II, Priority Action) (A-93-145)

Evaluate the dynamics of the MD-11 stall warning system to ensure that the "on" and "off" logic are consistent with providing the pilot timely information. (Class II, Priority Action) (A-93-146)

Conduct a thorough review of the MD-11 high altitude cruise longitudinal stability and control characteristics, stall warning margins, and stall buffet susceptibility to ensure that pilot responses to routine pitch attitude upsets do not result in hazardous pitch oscillations, structural damage, or any other condition that could lead to unsafe flight. (Class II, Priority Action) (A-93-147)

Require that fire-blocking materials identified as Testori 0200-316 and 0206-100 be replaced with new materials that meet the fire retardant requirements of 14 CFR 25.853. (Class II, Priority Action) (A-93-148)

Amend 14 CFR 25.853 to include a requirement to test the fire-retardant properties of fire blocking materials after they have been subjected to in-service wear. (Class II, Priority Action) (A-93-149)

Conduct research upon the effects of actual in-service wear on the continued airworthiness of fire-blocking materials. Based on the findings, require periodic actual in-service tests of fire-blocking materials to verify compliance with the requirements of 14 CFR 25.853. (Class II, Priority Action) (A-93-150)

Inform other certification authorities of the findings regarding the deterioration of the fire-blocking materials noted in this accident investigation with the view toward replacing them, as required. (Class II, Priority Action) (A-93-151)

Direct principal maintenance inspectors to inform operators of the need to periodically inspect fire-blocking materials for wear and damage and to replace defective materials. (Class II, Priority Action) (A-93-152)

Also, as result of the investigation of this accident, on June 29, 1993, the Safety Board issued the following safety recommendations to the Federal Aviation Administration:

Issue an Airworthiness Directive requiring the operators of MD-11s to install an interim flap/slat handle system or device to prevent the inadvertent deployment of the wing leading edge slats, when such a system or device becomes available. (Class I, Urgent Action) (A-93-81)

Issue an Air Carrier Operations Bulletin to Principal Operations Inspectors to verify that MD-11 operators have advised flightcrews of the potential for an inadvertent in-flight slat extension if contact is made with the flap/slat handle. (Class II, Priority Action) (A-93-82)

Require an expeditious installation of a redesigned flap/slat actuating system, when it becomes available for retrofit, that will prevent uncommanded and inadvertent deployment of the leading edge wing slats on MD-11 airplanes. (Class II, Priority Action) (A-93-83)

The FAA has advised the Safety Board, in a letter dated September 2, 1993, that on July 23, 1993, it issued Airworthiness Directive (AD) 93-15-03 that requires the installation of a retainer assembly on the upper pedestal flap/slat control module quadrant in the flight compartment, in accordance with the MD-11 Alert Service Bulletin A27-38, dated July 8, 1993. This AD is intended to prevent inadvertent slat deployment during flight at cruise altitude. Based on this information, the Safety Board is classifying Safety Recommendation A-93-81 "Closed--Acceptable Action."

In the letter, the FAA advised the Safety Board that it will issue an air carrier operations bulletin (ACOB) to direct principal operations inspectors to have their assigned MD-11 operators inform all flightcrews of the potential for an inadvertent in-flight slat extension if contact is made with the flap/slat handle. The Safety Board is classifying Safety Recommendation A-93-82 "Open--Acceptable Response," pending receipt of the ACOB.

With regard to Safety Recommendation A-93-83, the FAA has advised the Safety Board that it is working with McDonnell Douglas to expedite the review, approval, and installation of the redesigned flap/slat actuation system. Based on this information, the Safety Board is classifying Safety Recommendation A-93-83 "Open--Acceptable Response."

BY THE NATIONAL TRANSPORTATION SAFETY BOARD

Carl W. Vogt
Chairman

Susan Coughlin
Vice Chairman

John K. Lauber
Member

John Hammerschmidt
Member

James E. Hall
Member

October 27, 1993

5. APPENDIXES

APPENDIX A

INVESTIGATION AND HEARING

1. Investigation

The National Transportation Safety Board was notified of the accident and dispatched an investigator from the Anchorage, Alaska, field office on April 6, 1993.

In accordance with the provisions of Annex 13 to the International Civil Aviation Organization (ICAO), (Chapter 5, paragraph 5.3), the Civil Aviation Administration of China (CAAC) would have been responsible for the investigation of this accident because it occurred over international waters. However, on April 7, 1993, the CAAC, in accordance with paragraph 5.3, delegated the investigation of this accident to the Safety Board.

The CAAC participated in the investigation in accordance with the provisions of Annex 13.

A partial investigative team was dispatched from the Washington, D.C. Headquarters on April 7, 1993. The team was composed of an Investigator-In-Charge and the following groups: Systems, Structures, Survival Factors, and Cabin Safety. In addition, specialist reports were prepared to summarize findings relevant to the CVR and FDR.

Parties to the major investigation were the FAA, China Eastern Airlines, and Douglas Aircraft Company.

2. Public Hearing

A public hearing was not held in conjunction with this investigation.

APPENDIX B

**RESPONSE OF CIVIL AVIATION ADMINISTRATION OF CHINA TO
SAFETY BOARD'S DRAFT OF AVIATION ACCIDENT REPORT**

#1/3

中国民用航空局



CIVIL AVIATION
ADMINISTRATION OF CHINA

155 Dongsi St. West Beijing P.O. Box 644
People's Republic of China

CABLES: CIVILAIR BEIJING (PEKING)
TELEX: 22101 CAXT CN

TO:

October 4, 1993

Mr. Ronald L. Schleede

Chief, Major Investigation Division

FAX: 202 - 382 - 6576

Dear Mr. Schleede

We already have received the draft report of the China Eastern Airline's MD-11 accident.

First, We thank for NTSB's help and cooperating in this accident investigation. We think that the work of accident investigation group is conscientious, scientific, and that this report is basically correspond with the fact. So we agree to this report, except following Problems:

1. In 3.1 section "Findings". We think that should be added the sentence : "The design and construction of the flap/slat handle of MD-11 is not conformity with FAR, and Although FAA and Douglas Company have taken some efforts, but have not eliminated the potential for further inadvertent slat extension."

#2/3

2. In "Probable Cause" . We consider the sequence should be that:
 - A. There are some obvious defects in the design and construction of the flap/slat handle.
 - B. The pilot inadvertent contact with the flap/slat handle most likely and result extension of the leading edge slat during cruise flight, that will led to several violent pilot-induced pitch oscillations after the captain disconnected the outopilot to return to level flight.
 - C. We agree with you about the cause of the severity of the injuries.

3. Please to note that "The concerned department of CAAC took part in the accident investigation." On the correct place of this report.

Besides, We think that the problem about the "pilot-induced oscillations (PIO)" in this report should be considered futher, becous the PIO is generally connected with the dynamic characteristic of airplane. It is clearly noted in the MIL-8785 B that the airplane should not have tendency of PIO.

We also think that there are some deficiency in the service bulletins pertinent to the MD-11 slat system, for exampl, the Douglas company never noted how to controll the airplane by pilot, if the slat is inadvertently extended.

Above sections are our opiaious about your report.

We are welcome Mr. Feith to visit our office and to discuss this

3/3

report with us before October 27. If Mr. Feith will come to Beijing, please give me a Fax and tell me about Mr. Feith's passport number, Date of birth and so on as soon as possible, we'll send out a letter of invitation.

We are very glad to receive your invitation to attend the meeting on October 27 in Washington. We'll send people to attend this meeting, if there's still time.

Thank you for your help again.

Sincerely,

Ji-Jiushan 

Deputy Director

Department of Flight Standard and

Air Safety of CAAC

FAX: (86-1)4260369

ERRATA

**THESE CORRECTIONS SHOULD BE MADE
TO THE PREVIOUSLY PUBLISHED REPORT
IDENTIFIED AS FOLLOWS:**

AIRCRAFT ACCIDENT REPORT

TAKEOFF STALL IN ICING CONDITIONS

USAIR FLIGHT 405

FOKKER F-28, N485US

LAGUARDIA AIRPORT

FLUSHING, NEW YORK

MARCH 22, 1992

(NTSB/AAR-93/02 PB93-910402)

Page 49, paragraph 1, line 13

Change: ...(0.4-0.8 inch)...

To: ...(0.04-0.08 inch)...

ERRATA

THE FOLLOWING CORRECTIONS SHOULD BE MADE TO THE PREVIOUSLY PUBLISHED REPORT AS FOLLOWS:

AIRCRAFT ACCIDENT REPORT
ABORTED TAKEOFF SHORTLY AFTER LIFTOFF
TRANS WORLD AIRLINES FLIGHT 843
LOCKHEED L-1011, N11002
JOHN F. KENNEDY INTERNATIONAL AIRPORT
JAMAICA, NEW YORK
JULY 30, 1992

(NTSB/AAR-93/04 PB93-910404)

Page 19, last paragraph, line 1, first sentence

Change

The No.2 engine sustained....

To

The No.2 engine exterior was heavily sooted, but there was no fire or heat damage evident.

Page 19, last paragraph, last line

Change

...reversers were fully deployed.

To

...reversers were fully deployed and the thrust reverser cowl had sustained severe fire damage.

Page 74, Appendix C, table, Serial No. column

Change

10293

To

10295

ERRATA

**THESE CORRECTIONS SHOULD BE MADE
TO THE PREVIOUSLY PUBLISHED REPORT
IDENTIFIED AS FOLLOWS:**

SPECIAL INVESTIGATION REPORT

COMMERCIAL SPACE LAUNCH INCIDENT

**LAUNCH PROCEDURE ANOMALY
ORBITAL SCIENCES CORPORATION
PEGASUS/SCD-1**

**80 NAUTICAL MILES EAST OF CAPE CANAVERAL, FLORIDA
FEBRUARY 9, 1993**

NTSB/SIR-93/02 (PB93-917003)

Page 11, paragraph 4, line 1

Change: ...Dryden Command Center....

To: ...Command Center....

Page 45, paragraph 3, line 2

Change: .., was not prudent....

To: .., was prudent....

NATIONAL TRANSPORTATION SAFETY BOARD
Washington, D.C. 20594

Official Business
PENALTY FOR PRIVATE USE, \$300

THIRD CLASS BULK RATE
POSTAGE & FEES PAID
NATIONAL TRANSPORTATION
SAFETY BOARD

PERMIT NO. G-200

EMBRY-RIDDLE AERONAUTICAL
LIBRARY
3200 N WILLOW CREEK RD
PRESCOTT, AZ

86301

7