



WARNING

DO NOT USE THIS MANUAL OR ANY OF THE RELATED MATERIALS IN ANY WAY IN THE OPERATION, USE OR MAINTENANCE OF ANY AIRCRAFT. THESE MATERIALS HAVE BEEN PREPARED AND ARE PROVIDED SOLELY TO GIVE GUIDANCE ON THE LAYOUT AND STRUCTURE OF A TYPICAL AIRCRAFT MANUAL. THESE MATERIALS HAVE NOT BEEN APPROVED BY ANY AVIATION ADMINISTRATION FOR USE ON ANY AIRCRAFT AND SHOULD NEVER BE SO USED UNDER ANY CIRCUMSTANCES. FAILURE TO FOLLOW THIS WARNING COULD LEAD TO SERIOUS INJURY OR DEATH.

757-200  
Flight Crew  
Operations Manual  
The Boeing Company

Copyright © 1999  
The Boeing Company  
All Rights Reserved

Document Number D632N001-200

Revision Number: 6  
Revision Date: May 14, 2010



## Copyright Information

Boeing claims copyright in each page of this document only to the extent that the page contains copyrightable subject matter. Boeing also claims copyright in this document as a compilation and/or collective work.

The right to reproduce, distribute, display, and make derivative works from this document, or any portion thereof, requires a license from Boeing. For more information, contact The Boeing Company, P.O. Box 3707, Seattle, Washington 98124.

Boeing, the Boeing signature, the Boeing logo, 707, 717, 727, 737, 747, 757, 767, 777, 787, BBJ, DC-8, DC-9, DC-10, MD-10, MD-11, MD-80, MD-88, MD-90 and the Boeing livery are all trademarks of The Boeing Company. No trademark license is granted in connection with this document unless provided in writing by Boeing.

# DO NOT USE FOR FLIGHT

757 Flight Crew Operations Manual

## Preface Chapter Table of Contents

## Chapter 0 Section 0

### Volume 1

Title Page . . . . .	0
Preface . . . . .	0
V1V2 Model Identification . . . . .	0.1
Introduction . . . . .	0.2
Abbreviations . . . . .	0.3
V1V2 Revision Record . . . . .	0.4
V1V2 List of Effective Pages . . . . .	0.5
Bulletin Record . . . . .	0.6
Limitations . . . . .	L
Normal Procedures . . . . .	NP
Supplementary Procedures . . . . .	SP
Performance Inflight . . . . .	PI

### Volume 2

Airplane General, Emergency Equipment, Doors, Windows . . . . .	1
Air Systems . . . . .	2
Anti-Ice, Rain . . . . .	3
Automatic Flight . . . . .	4
Communications . . . . .	5
Electrical . . . . .	6
Engines, APU (RR) . . . . .	7
Engines, APU (PW) . . . . .	7
Fire Protection . . . . .	8
Flight Controls . . . . .	9
Flight Instruments, Displays . . . . .	10
Flight Management, Navigation . . . . .	11
Fuel . . . . .	12
Hydraulics . . . . .	13
Landing Gear . . . . .	14

---

Warning Systems ..... 15

#### General

The airplanes listed in the table below are covered in the Flight Crew Operations Manual (FCOM). The numbers are used to distinguish data peculiar to one or more, but not all of the airplanes. Where data applies to all airplanes listed, no reference is made to individual airplane numbers.

Use of the table below permits flight crew correlation of configuration differences by number within an operator's fleet for airplanes covered in this manual. Configuration data reflects the airplane as delivered configuration and is updated for service bulletin incorporations in conformance with the policy stated in the introduction section of this chapter.

Registry number is supplied by the national regulatory agency. Serial and tabulation numbers are supplied by Boeing.

Registry Number	Serial Number	Tabulation Number
TBC-01	BC001	BC001
TBC-02	BC002	BC002

Intentionally  
Blank

## General

This Flight Crew Operations Manual has been prepared by The Boeing Company. The purpose of this manual is to:

- provide the operating limitations, procedures, performance, and systems information the flight crew needs to safely and efficiently operate the 757 airplane during all anticipated operations
- serve as a comprehensive reference for use during transition training for the 757 airplane
- serve as a review guide for use in recurrent training and proficiency checks
- provide necessary operational data from the FAA approved airplane flight manual (AFM) to ensure that legal requirements are satisfied
- establish standardized procedures and practices to enhance Boeing operational philosophy and policy.

This manual is prepared for the owner/operator named on the title page specifically for the airplanes listed in the "Model Identification" section. It contains operational procedures and information, which apply only to these airplanes. The manual covers the Boeing delivered configuration of these airplanes. Changes to the delivered configuration are incorporated when covered by contractual revision agreements between the owner/operator and The Boeing Company.

This manual is not suitable for use for any airplanes not listed in the "Model Identification" section. Further, it may not be suitable for airplanes that have been transferred to other owners/operators.

Owners/operators are solely responsible for ensuring the operational documentation they are using is complete and matches the current configuration of the listed airplanes. This includes the accuracy and validity of all information furnished by the owner/operator or any other party. Owners/operators receiving active revision service are responsible to ensure that any modifications to the listed airplanes are properly reflected in the operational procedures and information contained in this manual.

The manual is periodically revised to incorporate pertinent procedural and systems information. Items of a more critical nature will be incorporated in operational bulletins and distributed in a timely manner. In all cases, such revisions and changes must remain compatible with the approved AFM with which the operator must comply. In the event of conflict with the AFM, the AFM shall supersede.

**DO NOT USE FOR FLIGHT**  
**757 Flight Crew Operations Manual**

---

This manual is written under the assumption that the user has had previous multi-engine jet aircraft experience and is familiar with basic jet airplane systems and basic pilot techniques common to airplanes of this type. Therefore, the operations manual does not contain basic flight information that is considered prerequisite training.

Any questions about the content or use of this manual can be directed to:

Boeing Commercial Airplanes

Commercial Aviation Services

Attn: 757 Manager, Flight Technical Data

P.O. Box 3707, M/C 20-89

Seattle, Washington, 98124-2207 USA

Email - [flightraining@boeing.com](mailto:flightraining@boeing.com)

Telephone: (206) 662-4000

Fax:(206) 662-4743



---

## Organization

The Flight Crew Operations Manual (FCOM) is organized in the following manner.

Volume 1 –

- Preface – contains general information regarding the manual’s purpose, structure, and content. It also contains lists of abbreviations, a record of revisions, bulletins, and a list of effective pages.
- Limitations and Normal Procedures chapters cover operational limitations and normal procedures. All operating procedures are based on a thorough analysis of crew activity required to operate the airplane, and reflect the latest knowledge and experience available.
- Supplementary Procedures chapter covers those procedures accomplished as required rather than routinely on each flight.
- Performance Inflight chapter contains performance information to supplement data from the Flight management Computer (FMC).

Volume 2 – Chapters 1 through 15 contain general airplane and systems information. These chapters are generally subdivided into sections covering controls and indicators and systems descriptions.

Quick Reference Handbook (QRH) – The QRH covers normal checklists, in–flight performance, non–normal checklists, and non–normal maneuvers.

---

## Page Numbering

The FCOM uses a decimal page numbering system. The page number is divided into three fields; chapter, section, and page. An example of a page number for the hydraulics chapter follows: chapter 13, section 20, page 3.

### Example Page Number

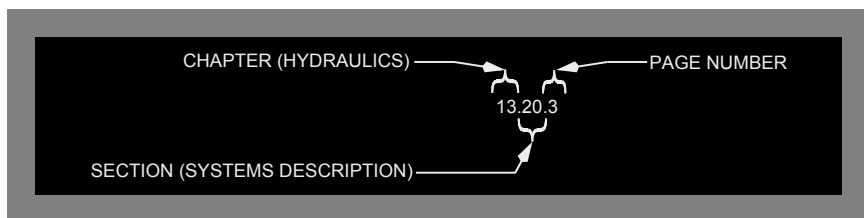

---

## Page Identification

Each page is identified by a customer document number and a page date. The customer document number is composed of the general 757 FCOM number, D632N001–, and is followed by the customer identification. The page date is the date of publication of the manual or the most recent revision date.

---

## Example Page Identification

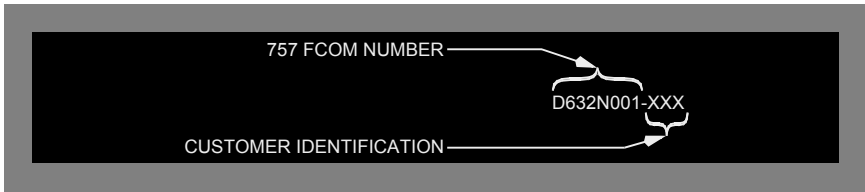

---

## Warnings, Cautions, and Notes

The following levels of written advisories are used throughout the manual and are not to be confused with EICAS messages, which are separately identified in the text.

**WARNING:** An operating procedure, technique, etc., that may result in personal injury or loss of life if not carefully followed.

**CAUTION:** An operating procedure, technique, etc., that may result in damage to equipment if not carefully followed.

**Note:** An operating procedure, technique, etc., considered essential to emphasize. Information contained in notes may also be safety related.

---

## Flight Crew Operations Manual Configuration

Customer airplane configuration determines the data provided in this manual. The Boeing Company keeps a list of each airplane configuration as it is built and modified through the Service Bulletin process. The FCOM does not reflect customer originated modifications without special contract provisions.

## Airplane Effectivities

Differences in airplane configuration are shown by use of airplane effectivities throughout Volumes 1 and 2, and the Quick Reference Handbook

The following rules are used to express airplane effectivities:

1. Airplane effectivities are listed in alpha-numeric order. A range of airplanes is defined by the word “through”, e.g. **N501BC through N505BC** includes all N5xxBC series aircraft in order as listed on the model ID page. A comma in the the range, e.g. **N501BC through N503BC, N505BC** indicates that **N504BC** is excluded from the range.
2. Airplane effectivities apply only to the paragraph, illustration, operational note, procedural step, etc. and to subordinate items (if any).

Example (with subordinate items):

**N501BC through N504BC**

**Right radio tuning panel.....Set**  
**Verify that the OFF light is extinguished.**

**First officer’s audio control panel.....Set**

In this example, the effectivity N501BC through N504BC applies to the first procedural step and further indented (subordinate) step only. The effectivity does not include the next equivalently indented step.

The first step (Right radio tuning panel) is effective for airplanes N501BC through N504BC, the second step (First officer’s audio control panel) is effective for all airplanes:

Example (without subordinate items):

**N501BC through N502BC**

**Thrust reversers inoperative.**

**Autobrake system inoperative.**

In this example, the effectivity N501BC through N502BC applies to the first operational note only. The effectivity does not apply to the next equivalently indented operational note.

The first operational note (Thrust reverser inoperative.) is effective for airplanes N501BC through N502BC only, the next operational note (Autobrake ...) is effective for all airplanes.

3. When airplane effectivities are stated immediately below a checklist title, the entire checklist applies to the listed airplanes only. In the following example, the OIL FILTER checklist is applicable to N501BC through N503BC only:



4. When Boeing has been notified airplanes are to be modified by service bulletin (SB), the effectivity statement will include 'Add' and 'Delete' versions, as appropriate, in parentheses. Depending upon the modification, there may not be both an 'Add' and an 'Delete' version.

The text before the semicolon in the parentheses lists the range of airplanes being modified. The text after the semicolon indicates the 'before' or 'after' version and briefly describes what the SB does. The following examples illustrate this:

Example ('Add' version):

**(SB Adds N504BC when Improved Oil Filters are installed)  
The engine may be operated normally.**

"SB Adds N504BC" means the incorporation of the SB (i.e. installation of improved Oil Filters in this example) is scheduled to begin for airplane N504BC. The words "SB Adds, when improved Oil Filters are installed" indicate the associated operational note (The engine may be operated normally.) applies to N504BC when the SB has been incorporated.

Example ('Deletes' version):

**(SB Deletes N504BC when improved Oil Filters are installed)  
The engine must be operated at idle thrust.**

For airplane N504BC the SB (i.e. installation of improved Oil Filters in this example) has not been incorporated. The associated operational note (The engine must be operated at idle thrust ) applies N504BC.

"SB Deletes N504BC" means the incorporation of the SB (i.e. installation of improved Oil Filters in this example) is scheduled to begin for airplane N504BC. The words "The engine must be operated at idle thrust " will apply to N504BC until the SB has been incorporated.

**General**

The following abbreviations may be found throughout the manual. Some abbreviations may also appear in lowercase letters. Abbreviations having very limited use are explained in the chapter where they are used.

A	
ABV	Above
AC	Alternating Current
ACARS	Aircraft Communications Addressing and Reporting System
ACP	Audio Control Panel
ACT	Active
ADC	Air Data Computer
ADF	Automatic Direction Finder
ADI	Attitude Director Indicator
ADIRS	Air Data Inertial Reference System
ADIRU	Air Data Inertial Reference Unit
AFDS	Autopilot Flight Director System
AFM	Airplane Flight Manual (FAA approved)
A/G	Air/Ground
AGL	Above Ground Level
AIL	Aileron
ALT	Altitude
ALTN	Alternate

AM	Amplitude Modulation
AMI	Airline Modifiable Information
ANP	Actual Navigational Performance
ANT	Antenna
AOA	Angle of Attack
A/P	Autopilot
APL	Airplane
APP	Approach
APU	Auxiliary Power Unit
ARINC	Aeronautical Radio, Incorporated
ARPT	Airport
ARR	Arrival
ASA	Autoland Status Annunciator
ASYM	Asymmetry
A/T	Autothrottle
ATA	Actual Time of Arrival
ATC	Air Traffic Control
ATT	Attitude
AUTO-THROT	Autothrottle
AUTO	Automatic

# DO NOT USE FOR FLIGHT

## 757 Flight Crew Operations Manual

AUX	Auxiliary
AVAIL	Available
B	
BARO	Barometric
BAT	Battery
B/CRS	Back Course
BFO	Beat Frequency Oscillator
BKR	Breaker
BLD	Bleed
BLW	Below
BRG	Bearing
BRT	Bright
BTL	Bottle
C	
C	Captain Celsius Center Cool
CANC	Cancel
CAP	Capture
CAPT	Captain
CB	Circuit Breaker
CDU	Control Display Unit
CG	Center of Gravity
CHR	Chronograph
CKT	Circuit
CL	Close
CLB	Climb
CLR	Clear
CMD	Command

CO	Company
COMM	Communication
COMP	Comparator
COMPT	Compartment
CON	Continuous
CONFIG	Configuration
CONT	Control
COOL	Cooling
CRS	Course
CRT	Cathode Ray Tube
CRZ	Cruise
CTL	Control
CTR	Center
CWS	Control Wheel Steering
D	
DA(H)	Decision Altitude (Height)
DC	Direct Current
DDG	Dispatch Deviations Guide
DEL	Delete
DEP	Departure
DEPR	Depressurize
DES	Descent
DH	Decision Height
DIFF	Differential
DISC	Disconnect
DISCH	Discharge
DK	Deck
DME	Distance Measuring Equipment

## 757 Flight Crew Operations Manual

DN	Down
DSPL	Display
E	
E/D	End of Descent
E/E	Electrical/Electronic
EEC	Electronic Engine Control
EFI	Electronic Flight Instruments
EFIS	Electronic Flight Instrument System
EGT	Exhaust Gas Temperature
EICAS	Engine Indication and Crew Alerting System
ELEC	Electrical
ELEV	Elevator
EMER	Emergency
ENG	Engine
ENT	Entry
EO	Engine Out
EPR	Engine Pressure Ratio
EQPT or EQUIP	Equipment
ETOPS	Extended Range Operation with Twin Engine Airplanes
EVAC	Evacuation
EXEC	Execute
EXT	Extend or External
F	
F	Fahrenheit

FADEC	Full Authority Digital Engine Control
FCC	Flight Control Computer
FCOM	Flight Crew Operations Manual
FD, F/D or FLT DIR	Flight Director
FF	Fuel Flow
FILT	Filter
FL CH or FLCH	Flight Level Change
FLT	Flight
FMA	Flight Mode Annunciations
FMC	Flight Management Computer
FMS	Flight Management System
F/O or F O	First Officer
FPA	Flight Path Angle
FPM	Feet Per Minute
FPV	Flight Path Vector
FREQ	Frequency
F/S	Fast/Slow
FT	Feet
FWD	Forward
FWSOV	Fire Wall Shut Off Valve
G	
GA	Go-Around
GEN	Generator
GMT	Greenwich Mean Time
GND	Ground

# DO NOT USE FOR FLIGHT

## 757 Flight Crew Operations Manual

GPS	Global Positioning System
GPWS	Ground Proximity Warning System
G/S	Glide Slope
GS	Ground Speed
H	
HDG	Heading
HF	High Frequency
HI	High
HLD	Hold
HPSOV	High Pressure Shut Off Valve
HSI	Horizontal Situation Indicator
HYD	Hydraulic
I	
IAS	Indicated Airspeed
IDENT	Identification
IGN	Ignition
IGS	Instrument Guidance System
IND LTS	Indicator Lights
INIT	Initialization
INSTR	Instrument
ILS	Instrument Landing System
INBD	Inboard
IND	Indicator
INOP	Inoperative
INT or INTPH	Interphone
INTC	Intercept

IRS	Inertial Reference System
ISA	International Standard Atmosphere
ISLN	Isolation
ISFD	Integrated Standby Flight Display
K	
K or KTS	Knots
KGS	Kilograms
L	
L	Left
LBS	Pounds
LD	Load
LDA	Localizer-type Directional Aid
LDG	Landing
LE	Leading Edge
LIM	Limit
LKD	Locked
L NAV or LNAV	Lateral Navigation
LOC	Localizer
LT	Light
M	
M	Mach
MAG	Magnetic
MAN	Manual
MAX	Maximum
MCP	Mode Control Panel
MDA(H)	Minimum Descent Altitude (Height)



**757 Flight Crew Operations Manual**

MEL	Minimum Equipment List
MFD	Multifunction Display
MIC	Microphone
MIN	Minimum
MLS	Microwave Landing System
MMO	Maximum Mach Operating Speed
MOD	Modify
MSG	Message
MTRS	Meters
N	
N	Normal
NAV	Navigation
NM	Nautical Miles
NORM	Normal
N1	Low Pressure Rotor Speed
N2	High Pressure Rotor Speed (Pratt & Whitney engines) Intermediate Pressure Rotor Speed (Rolls-Royce engines)
N3	High Pressure Rotor Speed (Rolls-Royce engines)
O	
OAT	Outside Air Temperature
OFST	Offset
OP	Open
OVHT	Overheat
OVRD	Override

OVSPD	Overspeed
OXY or O2	Oxygen
P	
PA	Passenger Address
PASS	Passenger
PCP	Pilot Call Panel
PERF	Performance
PES	Pitch Enhancement System
PF	Pilot Flying
PM	Pilot Monitoring
PNL	Panel
POS	Position
PPOS	Present Position
PRES or PRESS	Pressure
PREV	Previous
P/RST	Push To Reset
PROX	Proximity
PRV	Pressure Regulating Valve
PSI	Pounds Per Square Inch
PTH	Path
PTT	Push To Talk
PTU	Power Transfer Unit
PWR	Power
PWS	Predictive Windshear System
Q	
Q	Quantity
QFE	Local Station Pressure

# DO NOT USE FOR FLIGHT

## 757 Flight Crew Operations Manual

QNH	Local Station Pressure corrected to MSL
QTY	Quantity
R	
R	Right
RA	Radio Altitude Resolution Advisory
RAD	Radio
RAT	Ram Air Turbine
RDMI	Radio Distance Magnetic Indicator
REC	Recorder
RECIR or RECIRC	Recirculation
REF	Reference
REV	Reverse
RF	Refill
RMI	Radio Magnetic Indicator
RNP	Required Navigational Performance
RNV	Area Navigation (RNAV)
RPM	Revolutions Per Minute
RST	Reset
RSVR	Reservoir
R/T	Radio Transmit
RTE	Route
RTO	Rejected Takeoff
RUD	Rudder
RVSM	Reduced Vertical Separation Minimum
S	
SAT	Static Air Temperature

SB	Service Bulletin
S/C	Step Climb
SEL	Select
SDF	Simplified Directional Facility
SELCAL	Selective Calling
SENS	Sensitivity
SERV	Service
SPD	Speed
SPDBRK	Speedbrake
STAB	Stabilizer
STBY	Standby
SYS	System
T	
T or TRU	True
T or TK or TRK	Track
TA	Traffic Advisory
TAI	Thermal Anti-Ice
TAT	Total Air Temperature
T/C	Top of Climb
TCAS	Traffic Alert and Collision Avoidance System
T/D	Top of Descent
TE	Trailing Edge
TEMP	Temperature
TERR	Terrain
TFC	Traffic
TFR	Transfer
THR	Throttle Thrust

**757 Flight Crew Operations Manual**

TO or T/O	Takeoff
TO/GA	Takeoff/Go-Around
TURB	Turbine Turbulence
U	
UNLKD	Unlocked
UNSCHD or UNSCHED	Unscheduled
USB	Upper Side Band
UTC	Universal Time Coordinated
UTIL	Utility
V	
VA	Design maneuvering Speed
VAL	Valve
VERT	Vertical
VHF	Very High Frequency
VIB	Vibration
VLV	Valve
VMO	Maximum Operating Speed
V NAV or VNAV	Vertical Navigation
VOR	VHF Omnidirectional Range
VR	Rotation Speed
VREF	Reference Speed
VSI	Vertical Speed Indicator
V/S	Vertical Speed
VTK	Vertical Track
V1	Takeoff Decision Speed

V2	Takeoff Safety Speed
W	
W	Warm
WHL	Wheel
WPT	Waypoint
WXR	Weather Radar
X	
X-FEED	Crossfeed
XPDR or XPNDR	Transponder
XTK	Cross Track

Intentionally  
Blank

#### Revision Transmittal Letter

To: All holders of The Boeing Company 757 Flight Crew Operations Manual (FCOM), Boeing Document Number D632N001-200.

Subject: Flight Crew Operations Manual Revision.

**CAUTION. Before inserting this FCOM revision check the Bulletin Record, Section 6, against the enclosed Flight Crew Operations Manual Bulletins (OMBs). If all OMBs listed in Section 6 are enclosed, this FCOM has been completely reprinted for customer convenience due to the large number of changed pages.**

This revision reflects the most current information available to The Boeing Company 45 days prior to the subject revision date. The following revision highlights explain changes in this revision. The Revision Record page explains the use of revision bars to identify new or revised information.

#### Revision Record

No.	Revision Date	Date Filed
0	May 17, 2007	
2	May 15, 2008	
4	May 19, 2009	
6	May 14, 2010	

No.	Revision Date	Date Filed
1	November 20, 2007	
3	November 18, 2008	
5	November 13, 2009	

#### General

The Boeing Company issues FCOM revisions to provide new or revised procedures and information. Formal revisions also incorporate appropriate information from previously issued operations manual bulletins.

The revision date is the approximate date the manual is mailed to the customer and is effective upon receipt.

Formal revisions include a Transmittal Letter, a new Revision Record, Revision Highlights, and a current List of Effective Pages. Use the information on the new Revision Record and List of Effective Pages to verify the FCOM content.

---

Pages containing revised material have revision bars and highlights associated with the changed text or illustration. Revision bars associated with revised effectivity due to additions, deletions of airplanes or changes to previous registration numbers will not have highlights.

The record should be completed by the person incorporating the revision into the manual.

---

## **Filing Instructions**

Consult the List of Effective Pages (0.5). Pages identified with an asterisk (\*) are either replacement pages or new (original) issue pages. Remove corresponding old pages and replace or add new pages. Remove pages that are marked DELETED; there are no replacement pages for deleted pages.

Be careful when inserting changes not to throw away pages from the manual that are not replaced. The List of Effective Pages determines the correct content of the manual.

---

## **Revision Highlights**

This section (0.4) replaces the existing section 0.4 in your manual.

Throughout the manual, airplane effectivity may be updated to reflect coverage as listed on the Preface - Model Identification page, or to show service bulletin airplane effectivity. Highlights are not supplied.

This manual is published from a database; the text and illustrations are marked with configuration information. Occasionally, because the editors rearrange the database markers, or mark items with configuration information due to the addition of new database content, some customers may receive revision bars on content that appears to be unchanged. Pages may also be republished without revision bars due to slight changes in the flow of the document.

---

## **Chapter 0 - Preface**

### **Section 6 - Bulletin Record**

0.6.1 - Removed reference to temporary information for cross model standardization.

0.6.5 - Revised to reflect current bulletin status.

---

## **Chapter 0-B - Bulletins**

### **Section 1 - Covers**

0-B.1.1 - Corrected typographical error.

0-B.1.2 - Revised address to reflect updated information.

---

**Section 2 - Covers**

0-B.2.2 - Revised address to reflect updated information.

**Section 3 - Covers**

0-B.3.2 - Revised address to reflect updated information.

**Section 4 - Covers**

0-B.4.2 - Revised address to reflect updated information.

**Section 5 - Covers**

0-B.5.2 - Revised address to reflect updated information.

**Section 6 - Covers**

0-B.6.3 - Revised address to reflect updated information.

**Section 7 - Covers**

0-B.7.2 - Revised address to reflect updated information.

**Section 8 - Covers**

0-B.8.2 - Revised address to reflect updated information.

**Section 9 - Covers**

0-B.9.2 - Revised address to reflect updated information.

**Section 10 - Covers**

0-B.10.2 - Revised address to reflect updated information.

**Section 11 - Covers**

0-B.11.2 - Revised address to reflect updated information.

**Section 12 - Covers**

0-B.12.2 - Revised address to reflect updated information.

**Section 13 - Covers**

0-B.13.2 - Revised address to reflect updated information.

**Section 14 - Covers**

0-B.14.2 - Revised address to reflect updated information.

**Section 15 - Covers**

0-B.15.2 - Revised address to reflect updated information.

**Section 16 - Covers**

0-B.16.2 - Revised address to reflect updated information.

**Section 17 - Covers**

0-B.17.2 - Revised address to reflect updated information.

**Section 18 - Covers**

0-B.18.3 - Revised address to reflect updated information.

**Section 19 - Covers**

0-B.19.2 - Revised address to reflect updated information.

**Section 20 - Covers**

0-B.20.2 - Revised address to reflect updated information.

**Section 21 - Covers**

0-B.21.2 - Revised address to reflect updated information.

**Section 22 - Covers**

0-B.22.2 - Revised address to reflect updated information.

**Section 23 - Covers**

0-B.23.2 - Revised address to reflect updated information.

**Section 24 - Covers**

0-B.24.2 - Revised address to reflect updated information.

**Section 25 - Covers**

0-B.25.2 - Revised address to reflect updated information.

**Section 26 - Covers**

0-B.26.2 - Revised address to reflect updated information.

**Section 27 - Covers**

0-B.27.2 - Revised address to reflect updated information.

**Section 28 - Covers**

0-B.28.2 - Revised address to reflect updated information.

**Section 29 - Covers**

0-B.29.2 - Revised address to reflect updated information.

**Section 30 - Covers**

0-B.30.2 - Revised address to reflect updated information.

**Section 31 - Covers**

0-B.31.2 - Revised address to reflect updated information.



---

**Section 32 - Covers**

0-B.32.2 - Revised address to reflect updated information.

**Section 33 - Covers**

0-B.33.3 - Revised address to reflect updated information.

**Section 34 - Covers**

0-B.34.4 - Revised address to reflect updated information.

**Section 35 - Covers**

0-B.35.2 - Revised address to reflect updated information.

**Section 36 - Covers**

0-B.36.3 - Revised address to reflect updated information.

**Section 37 - Covers**

0-B.37.2 - Revised address to reflect updated information.

**Section 38 - Covers**

0-B.38.2 - Revised address to reflect updated information.

**Section 39 - Covers**

0-B.39.2 - Revised address to reflect updated information.

**Section 40 - Covers**

0-B.40.2 - Revised address to reflect updated information.

**Section 41 - Covers**

0-B.41.2 - Revised address to reflect updated information.

**Section 42 - Covers**

0-B.42.2 - Revised address to reflect updated information.

**Section 43 - Covers**

0-B.43.2 - Revised address to reflect updated information.

**Section 44 - Covers**

0-B.44.4 - Revised address to reflect updated information.

**Section 45 - Covers**

0-B.45.3 - Revised address to reflect updated information.

**Section 46 - Covers**

0-B.46.3 - Revised address to reflect updated information.

**Section 47 - Covers**

0-B.47.2 - Revised address to reflect updated information.

**Section 48 - Covers**

0-B.48.3 - Revised address to reflect updated information.

**Section 49 - Covers**

0-B.49.2 - Revised address to reflect updated information.

**Section 50 - Covers**

0-B.50.2 - Revised address to reflect updated information.

**Section 51 - Covers**

0-B.51.2 - Revised address to reflect updated information.

**Section 52 - Covers**

0-B.52.2 - Revised address to reflect updated information.

**Section 53 - Covers**

0-B.53.2 - Revised address to reflect updated information.

**Section 54 - Covers**

0-B.54.3 - Revised address to reflect updated information.

**Section 56 - Covers**

0-B.56.3 - Revised address to reflect updated information.

**Section 57 - Covers**

0-B.57.3 - Revised address to reflect updated information.

---

**Chapter NP - Normal Procedures**

**Section 21 - Amplified Procedures**

Preflight Procedure – First Officer

NP.21.15 - Added nomenclature for oxygen masks with "RESET/TEST" switch.

NP.21.15 - Added nomenclature for oxygen masks with "TEST AND RESET" switch.

Preflight Procedure – Captain

NP.21.20-21 - Added nomenclature for oxygen masks with "RESET/TEST" switch.

NP.21.20 - Added nomenclature for oxygen masks with "TEST AND RESET" switch.

---

Before Start Procedure

NP.21.27 - Revised to verify both PRESS lights illuminated.

Climb and Cruise Procedure

NP.21.38 - Revised information to advise crews to refer to the Center Tank Fuel Pumps Operations manual bulletin for procedures in climb and cruise.

Shutdown Procedure

NP.21.48 - Relocated Status messages before Transponder to reflect scan flow and the 767 procedure.

---

**Chapter SP - Supplementary Procedures**

**Section 4 - Automatic Flight**

AFDS

SP.4.1 - Clarified Heading Hold description. Aligned with FCOM Volume 2 Autoflight System Description.

---

**Chapter PI - Performance Inflight**

**Section 10 - Table of Contents**

PI.TOC.10.1 - 757-200 535E4 LB FAA was added as Section 10.

**Section 12 - Advisory Information**

Non-Normal Configuration Landing Distance

PI.12.4,6,8,10 - Added the LE SLAT ASYMMETRY 5 <= FLAPS < 20 landing configuration to reflect the revised Non-Normal Checklist. This addition alters the existing LE SLAT ASYMMETRY data for FLAPS >20 and FLAPS=20.

**Section 20 - Table of Contents**

PI.TOC.20.1 - 757-200 PW2037 LB FAA was added as Section 20.

**Section 22 - Advisory Information**

Non-Normal Configuration Landing Distance

PI.22.4,6,8,10 - Added the LE SLAT ASYMMETRY 5 <= FLAPS < 20 landing configuration to reflect the revised Non-Normal Checklist. This addition alters the existing LE SLAT ASYMMETRY data for FLAPS >20 and FLAPS=20.

---

---

## **Chapter 1 - Airplane General, Emergency Equipment, Doors, Windows**

### **Section 30 - Controls and Indicators**

#### Alternate Action Switches

1.30.1 - Description of alternate action switches changed.

#### Oxygen Mask Panel

1.30.22 - Adds Reset/Test switch explanation for Oronasal masks.

1.30.22 - Adds Scott Full Face oxygen panel test and reset switch description.

1.30.22 - Revised title to match panel.

1.30.22 - Adds Full Face Mask, left door in open position description.

---

## **Chapter 2 - Air Systems**

### **Section 30 - Pressurization System Description**

#### Introduction

2.30.1 - Changed negative relief door to negative (vacuum) relief valves to more accurately describe negative pressure protection for the 757.

#### Non-Normal Indications

2.30.2 - Added additional information on the use of Manual operation of the pressurization system for clarity.

---

## **Chapter 4 - Automatic Flight**

### **Section 10 - Controls and Indicators**

#### Autopilot Flight Director Roll and Pitch Controls

4.10.6 - Corrected LNAV deactivation parameters. Removed reference to re-engagement.

---

## **Chapter 6 - Electrical**

### **Section 20 - System Description**

#### Introduction

6.20.1 - Deleted system description for aircraft without a hydraulic driven generator.

#### AC Electrical System Schematic (Hydraulic Driven Generator)

6.20.5 - Deleted illustration depicting the AC Electrical System without a hydraulic driven generator installed.

---

---

## **Chapter 10 - Flight Instruments, Displays**

### **Section 10 - EFIS Controls and Indicators**

ADI Speed Tape

10.10.11,13 - Corrected spelling of the word "maneuvering".

---

---

## **Chapter 11 - Flight Management, Navigation**

### **Section 10 - Controls and Indicators**

Control Display Unit (CDU)

11.10.1 - Clarified MCDU in illustration.

### **Section 20 - Navigation Systems Description**

IRS Alignment

11.20.2 - Changed title from "Fast Alignment" to "Fast Realignment".

Realignment more accurately describes procedure and is consistent with Supplementary Procedures, SP.11.

11.20.2 - Updated terminology from "fast alignment" to "fast realignment" to more accurately describe procedure.

### **Section 31 - Flight Management System Operation**

Descent

11.31.20 - VNAV descent description clarified and consolidated. Description standardized across airplane models.

11.31.21 - Top of descent (T/D) description clarified and standardized with other airplane models.

11.31.21 - VNAV descent description clarified and standardized with other airplane models.

11.31.21 - No technical change. MCP altitude reset reworded and standardized with other airplane models.

11.31.22-23 - No technical change. VNAV descent reworded and standardized with other airplane models.

11.31.23 - Added paragraph describing VNAV Early Descent.

11.31.23 - No technical change. Early Descent reworded and standardized with other airplane models.

11.31.23 - Added description of VNAV Descent for airplanes without Altitude Intervention.

## **Chapter 15 - Warning Systems**

### **Section 20 - System Description**

#### GPWS Alert Prioritization

15.20.15 - Corrected spelling of the word "descent".

#### GPWS Callouts

15.20.17 - Corrected spelling of the word "degrees".

### **Section 30 - EICAS Messages**

#### TCAS

15.30.1 - Added message inhibit description for the EICAS advisory message "TCAS OFF".

# DO NOT USE FOR FLIGHT

## 757 Flight Crew Operations Manual

### Preface

### V1V2 List of Effective Pages

### Chapter 0

### Section 5

Page	Date
<b>Volume 1</b>	
* Title Page	May 14, 2010
* Copyright	May 14, 2010
0.TOC.0.1-2	November 18, 2008
* 0.1.1-2	May 14, 2010
0.2.1	May 15, 2008
0.2.2	November 13, 2009
0.2.3	May 19, 2009
0.2.4	May 15, 2008
0.2.5-6	November 13, 2009
0.3.1-4	May 15, 2008
0.3.5-7	November 18, 2008
0.3.8	May 15, 2008
Revision Record (tab)	
* 0.4.1-10	May 14, 2010
List of Effective Pages	
* 0.5.1-10	May 14, 2010
Bulletins (tab)	
* 0.6.1-6	May 14, 2010
* 0-B.1.1.1-2	May 14, 2010
0-B.2.1	November 18, 2008
* 0-B.2.2	May 14, 2010
0-B.3.1	November 18, 2008
* 0-B.3.2	May 14, 2010
0-B.4.1	November 18, 2008
* 0-B.4.2	May 14, 2010
0-B.5.1	November 18, 2008

Page	Date
Bulletins (cont)	
* 0-B.5.2	May 14, 2010
0-B.6.1-2	November 18, 2008
* 0-B.6.3	May 14, 2010
0-B.6.4-34	November 18, 2008
0-B.7.1	November 18, 2008
* 0-B.7.2	May 14, 2010
0-B.8.1	November 18, 2008
* 0-B.8.2	May 14, 2010
0-B.9.1	November 18, 2008
* 0-B.9.2	May 14, 2010
0-B.10.1	November 18, 2008
* 0-B.10.2	May 14, 2010
0-B.11.1	November 18, 2008
* 0-B.11.2	May 14, 2010
0-B.12.1	November 18, 2008
* 0-B.12.2	May 14, 2010
0-B.13.1	November 18, 2008
* 0-B.13.2	May 14, 2010
0-B.14.1	November 18, 2008
* 0-B.14.2	May 14, 2010
0-B.15.1	November 18, 2008
* 0-B.15.2	May 14, 2010
0-B.16.1	November 18, 2008
* 0-B.16.2	May 14, 2010
0-B.17.1	November 18, 2008
* 0-B.17.2	May 14, 2010
0-B.18.1-2	November 18, 2008
* 0-B.18.3	May 14, 2010

\* = Revised, Added, or Deleted

Copyright © The Boeing Company. See title page for details.

Page	Date	Page	Date
Bulletins (cont)		Bulletins (cont)	
0-B.18.4	November 18, 2008	* 0-B.33.3	May 14, 2010
0-B.19.1	November 18, 2008	0-B.33.4	November 18, 2008
* 0-B.19.2	May 14, 2010	0-B.34.1-3	November 18, 2008
0-B.20.1	November 18, 2008	* 0-B.34.4	May 14, 2010
* 0-B.20.2	May 14, 2010	0-B.35.1	November 18, 2008
0-B.21.1	November 18, 2008	* 0-B.35.2	May 14, 2010
* 0-B.21.2	May 14, 2010	0-B.36.1-2	November 18, 2008
0-B.22.1	November 18, 2008	* 0-B.36.3	May 14, 2010
* 0-B.22.2	May 14, 2010	0-B.36.4	November 18, 2008
0-B.23.1	November 18, 2008	0-B.37.1	November 18, 2008
* 0-B.23.2	May 14, 2010	* 0-B.37.2	May 14, 2010
0-B.24.1	November 18, 2008	0-B.38.1	November 18, 2008
* 0-B.24.2	May 14, 2010	* 0-B.38.2	May 14, 2010
0-B.25.1	November 18, 2008	0-B.39.1	November 18, 2008
* 0-B.25.2	May 14, 2010	* 0-B.39.2	May 14, 2010
0-B.26.1	November 18, 2008	0-B.40.1	November 18, 2008
* 0-B.26.2	May 14, 2010	* 0-B.40.2	May 14, 2010
0-B.27.1	November 18, 2008	0-B.41.1	November 18, 2008
* 0-B.27.2	May 14, 2010	* 0-B.41.2	May 14, 2010
0-B.28.1	November 18, 2008	0-B.42.1	November 18, 2008
* 0-B.28.2	May 14, 2010	* 0-B.42.2	May 14, 2010
0-B.29.1	November 18, 2008	0-B.43.1	November 18, 2008
* 0-B.29.2	May 14, 2010	* 0-B.43.2	May 14, 2010
0-B.30.1	November 18, 2008	0-B.44.1-3	November 18, 2008
* 0-B.30.2	May 14, 2010	* 0-B.44.4	May 14, 2010
0-B.31.1	November 18, 2008	0-B.45.1-2	November 18, 2008
* 0-B.31.2	May 14, 2010	* 0-B.45.3	May 14, 2010
0-B.32.1	November 18, 2008	0-B.45.4	November 18, 2008
* 0-B.32.2	May 14, 2010	0-B.46.1-2	November 18, 2008
0-B.33.1-2	November 18, 2008	* 0-B.46.3	May 14, 2010

\* = Revised, Added, or Deleted



Page	Date	Page	Date
Bulletins (cont)		Normal Procedures (tab)	
0-B.46.4	November 18, 2008	* NP.TOC.0.1-2	May 14, 2010
0-B.47.1	November 18, 2008	NP.11.1	November 20, 2007
* 0-B.47.2	May 14, 2010	NP.11.2	November 18, 2008
0-B.48.1-2	November 18, 2008	NP.11.3	November 20, 2007
* 0-B.48.3	May 14, 2010	NP.11.4	May 15, 2008
0-B.48.4	November 18, 2008	NP.11.5-7	November 20, 2007
0-B.49.1	November 18, 2008	NP.11.8	November 18, 2008
* 0-B.49.2	May 14, 2010	NP.21.1	May 17, 2007
0-B.50.1	November 18, 2008	NP.21.2	May 19, 2009
* 0-B.50.2	May 14, 2010	NP.21.3	May 17, 2007
0-B.51.1	November 18, 2008	NP.21.4	May 19, 2009
* 0-B.51.2	May 14, 2010	NP.21.5-10	May 17, 2007
0-B.52.1	November 18, 2008	NP.21.11	November 20, 2007
* 0-B.52.2	May 14, 2010	NP.21.12-14	May 17, 2007
0-B.53.1	November 18, 2008	* NP.21.15-50	May 14, 2010
* 0-B.53.2	May 14, 2010	Supplementary Procedures (tab)	
0-B.54.1-2	November 18, 2008	* SP.TOC.0.1-6	May 14, 2010
* 0-B.54.3	May 14, 2010	SP.05.1	November 18, 2008
0-B.54.4	November 18, 2008	SP.05.2	May 15, 2008
0-B.56.1-2	November 13, 2009	SP.1.1-4	May 19, 2009
* 0-B.56.3	May 14, 2010	SP.2.1-2	May 19, 2009
0-B.56.4	November 13, 2009	SP.3.1-2	May 17, 2007
* 0-B.57.1-4	May 14, 2010	* SP.4.1	May 14, 2010
Limitations (tab)		SP.4.2-8	May 17, 2007
L.TOC.0.1-2	November 18, 2008	SP.5.1-2	May 17, 2007
L.10.1	November 18, 2008	SP.6.1-2	May 17, 2007
L.10.2	May 19, 2009	SP.6.3	May 19, 2009
L.10.3-4	November 18, 2008	SP.6.4	May 17, 2007
L.10.5-6	May 17, 2007	SP.6.5	May 19, 2009
		SP.6.6	May 17, 2007

\* = Revised, Added, or Deleted

Page	Date	Page	Date
Supplementary Procedures (cont)		Performance - Inflight (cont)	
* SP.7.1	May 14, 2010	PI.16.1-4	November 18, 2008
SP.7.2-4	May 17, 2007	PI.17.1-2	November 18, 2008
SP.8.1-2	May 17, 2007	* PI.17.3-4	May 14, 2010
* SP.10.1-2	May 14, 2010	PI.17.5-9	November 18, 2008
SP.11.1-14	May 17, 2007	* PI.17.10	May 14, 2010
SP.12.1-2	May 17, 2007	PI.17.11-14	November 18, 2008
SP.15.1-2	May 17, 2007	* PI.TOC.20.1-4	May 14, 2010
SP.16.1-2	November 13, 2009	PI.20.1-22	November 18, 2008
SP.16.3	May 19, 2009	* PI.20.23-28	May 14, 2010
SP.16.4	November 18, 2008	* PI.20.29-30	Deleted
SP.16.5-16	November 13, 2009	PI.21.1	May 19, 2009
Performance - Inflight (tab)		PI.21.2-6	November 18, 2008
PI.TOC.1-2	May 15, 2008	PI.22.1-3	November 18, 2008
* PI.TOC.10.1-4	May 14, 2010	* PI.22.4	May 14, 2010
PI.10.1-8	November 18, 2008	PI.22.5	November 18, 2008
PI.10.9	May 19, 2009	* PI.22.6	May 14, 2010
PI.10.10-16	November 18, 2008	PI.22.7	November 18, 2008
PI.11.1-6	November 18, 2008	* PI.22.8	May 14, 2010
PI.12.1-3	November 18, 2008	PI.22.9	November 18, 2008
* PI.12.4	May 14, 2010	* PI.22.10	May 14, 2010
PI.12.5	November 18, 2008	PI.22.11-12	November 13, 2009
* PI.12.6	May 14, 2010	PI.23.1-8	November 18, 2008
PI.12.7	November 18, 2008	PI.24.1-10	November 18, 2008
* PI.12.8	May 14, 2010	PI.25.1-4	November 18, 2008
PI.12.9	November 18, 2008	PI.26.1-4	November 18, 2008
* PI.12.10	May 14, 2010	PI.27.1-2	November 18, 2008
PI.12.11-12	November 13, 2009	* PI.27.3	May 14, 2010
PI.13.1-8	November 18, 2008	PI.27.4-14	November 18, 2008
PI.14.1-8	November 18, 2008	<b>(blank tab)</b>	
PI.15.1-4	November 18, 2008		

\* = Revised, Added, or Deleted

Page	Date	Page	Date
<b>Volume 2</b>		<b>2 Air Systems (tab)</b>	
1 Airplane General, Emergency Equipment, Doors, Windows (tab)		2.TOC.0.1-2	May 15, 2008
1.TOC.0.1-4	May 15, 2008	2.10.1-10	May 17, 2007
1.10.1-4	May 17, 2007	2.20.1	May 17, 2007
1.20.1-4	May 17, 2007	2.20.2	May 15, 2008
1.21.1-2	May 17, 2007	2.20.3	May 17, 2007
1.21.3	May 15, 2008	2.20.4	May 15, 2008
1.21.4	May 17, 2007	2.20.5-6	May 17, 2007
1.22.1-4	May 17, 2007	* 2.30.1-2	May 14, 2010
* 1.30.1	May 14, 2010	2.40.1	May 15, 2008
1.30.2-3	May 17, 2007	2.40.2	May 17, 2007
1.30.4-7	November 20, 2007	* 2.40.3-4	May 14, 2010
1.30.8-10	May 17, 2007	2.50.1-2	November 13, 2009
1.30.11-12	November 20, 2007	<b>3 Anti-Ice, Rain (tab)</b>	
1.30.13-14	May 17, 2007	3.TOC.0.1-2	May 15, 2008
1.30.15	May 19, 2009	3.10.1-4	May 17, 2007
1.30.16	May 17, 2007	3.20.1	May 17, 2007
1.30.17	November 20, 2007	* 3.20.2-3	May 14, 2010
1.30.18	May 19, 2009	3.20.4	May 17, 2007
1.30.19-20	November 20, 2007	3.30.1-2	May 17, 2007
1.30.21	May 17, 2007	<b>4 Automatic Flight (tab)</b>	
* 1.30.22-24	May 14, 2010	4.TOC.0.1-2	November 13, 2009
1.40.1-4	May 17, 2007	4.10.1	May 17, 2007
1.40.5-7	May 19, 2009	4.10.2	November 18, 2008
1.40.8-16	May 17, 2007	4.10.3-4	May 17, 2007
1.45.1	May 17, 2007	4.10.5	November 13, 2009
1.45.2	November 18, 2008	* 4.10.6	May 14, 2010
1.45.3-6	May 17, 2007	4.10.7-13	November 13, 2009
1.50.1-4	May 17, 2007	4.10.14	May 17, 2007
		4.10.15-16	November 18, 2008
		4.10.17	May 17, 2007

\* = Revised, Added, or Deleted

Page	Date	Page	Date
4 Automatic Flight (cont)		7 Engines, APU (tab)	
4.10.18-20	November 18, 2008	7.TOC.0.1-4	May 15, 2008
4.10.21-22	May 17, 2007	7.10.1-2	May 17, 2007
4.20.1-2	May 17, 2007	7.10.3-4	May 15, 2008
4.20.3	November 18, 2008	7.10.5	May 17, 2007
4.20.4	May 17, 2007	7.10.6	May 19, 2009
4.20.5-7	November 18, 2008	7.10.7-24	May 17, 2007
4.20.8	May 19, 2009	7.11.1-2	May 17, 2007
4.20.9-20	November 18, 2008	7.11.3-4	May 15, 2008
4.30.1-2	May 17, 2007	7.11.5	May 19, 2009
5 Communications (tab)		7.11.6-22	May 17, 2007
5.TOC.0.1-2	May 15, 2008	7.15.1-2	May 17, 2007
5.10.1-2	May 17, 2007	7.20.1-6	May 17, 2007
5.10.3-4	November 20, 2007	7.20.7	May 19, 2009
5.10.5-6	May 17, 2007	7.20.8-18	May 17, 2007
5.10.7	November 20, 2007	7.21.1-5	May 17, 2007
5.10.8	May 17, 2007	7.21.6	November 18, 2008
5.10.9	November 20, 2007	7.21.7-18	May 17, 2007
5.10.10	May 17, 2007	7.30.1-2	May 17, 2007
5.20.1	May 17, 2007	7.40.1-2	May 17, 2007
5.20.2-6	May 15, 2008	7.41.1	May 17, 2007
5.30.1-4	May 17, 2007	7.41.2	November 18, 2008
5.40.1-4	May 17, 2007		
5.50.1-2	May 17, 2007		
6 Electrical (tab)			
* 6.TOC.0.1-2	May 14, 2010		
6.10.1-6	May 17, 2007		
* 6.20.1-12	May 14, 2010		
* 6.20.13-14	Deleted		
6.30.1-2	May 17, 2007		

\* = Revised, Added, or Deleted

**DO NOT USE FOR FLIGHT** V1V2 List of Effective Pages  
**757 Flight Crew Operations Manual**

Page	Date	Page	Date
8 Fire Protection (tab)		10 Flight Instruments, Displays (cont)	
8.TOC.0.1-2	May 15, 2008	10.30.3-4	May 15, 2008
8.10.1-5	May 17, 2007	10.30.5-10	May 17, 2007
* 8.10.6-7	May 14, 2010	10.40.1-2	May 17, 2007
8.10.8	May 17, 2007	10.40.3	November 13, 2009
8.20.1-2	May 17, 2007	10.40.4-6	May 17, 2007
8.20.3	November 20, 2007	10.50.1	November 13, 2009
8.20.4	May 17, 2007	10.50.2	May 17, 2007
8.20.5	November 20, 2007	11 Flight Management, Navigation (tab)	
8.20.6	May 17, 2007	* 11.TOC.0.1-6	May 14, 2010
8.30.1-2	May 17, 2007	* 11.10.1	May 14, 2010
9 Flight Controls (tab)		11.10.2-4	May 17, 2007
9.TOC.0.1-2	May 15, 2008	11.10.5	November 18, 2008
9.10.1	May 17, 2007	11.10.6-18	May 17, 2007
9.10.2-3	November 20, 2007	11.20.1	May 17, 2007
9.10.4-12	May 17, 2007	* 11.20.2	May 14, 2010
9.20.1-12	May 17, 2007	11.20.3-8	May 17, 2007
9.30.1-2	May 17, 2007	11.30.1-2	May 17, 2007
10 Flight Instruments, Displays (tab)		11.31.1-4	May 17, 2007
10.TOC.0.1-4	November 13, 2009	11.31.5	May 19, 2009
10.10.1-2	November 13, 2009	11.31.6-7	May 17, 2007
10.10.3-4	November 20, 2007	11.31.8	November 13, 2009
10.10.5-10	November 13, 2009	11.31.9	May 17, 2007
* 10.10.11	May 14, 2010	* 11.31.10-12	May 14, 2010
10.10.12	November 13, 2009	11.31.13-19	May 17, 2007
* 10.10.13	May 14, 2010	* 11.31.20-32	May 14, 2010
10.10.14-62	November 13, 2009	11.32.1	May 19, 2009
10.20.1-2	May 17, 2007	11.32.2-4	May 17, 2007
10.20.3	November 13, 2009	11.40.1-3	May 17, 2007
10.20.4-6	May 19, 2009	11.40.4	November 20, 2007
10.30.1-2	May 17, 2007	11.40.5	May 19, 2009

\* = Revised, Added, or Deleted

Page	Date	Page	Date
11 Flight Management, Navigation (cont)		11 Flight Management, Navigation (cont)	
11.40.6	May 17, 2007	11.43.22	November 18, 2008
11.40.7	May 19, 2009	11.43.23-26	May 17, 2007
11.40.8	November 18, 2008	11.50.1-6	May 17, 2007
11.40.9-15	May 17, 2007	11.60.1-6	May 17, 2007
11.40.16	November 18, 2008	<b>12 Fuel (tab)</b>	
11.40.17-26	May 17, 2007	12.TOC.0.1-2	May 15, 2008
11.40.27	November 18, 2008	12.10.1-4	May 17, 2007
11.40.28-29	May 17, 2007	12.20.1-6	May 17, 2007
11.40.30	November 18, 2008	12.30.1-2	May 17, 2007
11.40.31-34	May 17, 2007	<b>13 Hydraulics (tab)</b>	
11.41.1	November 13, 2009	13.TOC.0.1-2	May 15, 2008
11.41.2-12	May 17, 2007	13.10.1-4	May 17, 2007
11.42.1	May 17, 2007	13.20.1-6	May 17, 2007
11.42.2	November 18, 2008	13.30.1-2	May 17, 2007
11.42.3	May 17, 2007	<b>14 Landing Gear (tab)</b>	
11.42.4	November 18, 2008	14.TOC.0.1-2	May 19, 2009
11.42.5	May 17, 2007	14.10.1-2	May 17, 2007
11.42.6	November 18, 2008	14.10.3-7	November 20, 2007
11.42.7-9	May 17, 2007	14.10.8	May 17, 2007
11.42.10	November 18, 2008	14.20.1	May 19, 2009
11.42.11-13	May 17, 2007	14.20.2	May 17, 2007
11.42.14	November 18, 2008	14.20.3-5	May 19, 2009
11.42.15-27	May 17, 2007	14.20.6	May 17, 2007
11.42.28	November 13, 2009	14.30.1	May 19, 2009
11.42.29	November 18, 2008	14.30.2	May 17, 2007
11.42.30-37	May 17, 2007	<b>15 Warning Systems (tab)</b>	
* 11.42.38-40	May 14, 2010	15.TOC.0.1-4	November 13, 2009
11.42.41	November 13, 2009	15.10.1-10	May 17, 2007
11.42.42-44	May 17, 2007	15.10.11	May 15, 2008
11.43.1-21	May 17, 2007	15.10.12	November 20, 2007

\* = Revised, Added, or Deleted

Page	Date
15 Warning Systems (cont)	
15.10.13	November 13, 2009
15.10.14-15	November 20, 2007
15.10.16-17	May 15, 2008
15.10.18	May 17, 2007
15.10.19-20	November 13, 2009
15.10.21	May 15, 2008
15.10.22	November 20, 2007
15.10.23	November 18, 2008
15.10.24	May 15, 2008
* 15.10.25-26	May 14, 2010
15.10.27-28	May 15, 2008
15.20.1-3	November 18, 2008
15.20.4	May 17, 2007
15.20.5-6	November 20, 2007
15.20.7-13	November 13, 2009
15.20.14	May 15, 2008
* 15.20.15	May 14, 2010
15.20.16	May 15, 2008
* 15.20.17	May 14, 2010
15.20.18-20	May 15, 2008
15.20.21	November 20, 2007
15.20.22-24	November 13, 2009
15.20.25-29	November 20, 2007
15.20.30-31	May 15, 2008
15.20.32	November 20, 2007
* 15.30.1-2	May 14, 2010
<b>(blank tab)</b>	

\* = Revised, Added, or Deleted

Intentionally  
Blank

\* = Revised, Added, or Deleted



**General**

The Boeing Company issues Flight Crew Operations Manual Bulletins to provide important information to flight crews prior to the next formal revision of the Flight Crew Operations Manual. The transmitted information may be of interest to only specific Operators or may apply to all Operators of this model airplane. Each bulletin will vary.

Bulletins are numbered sequentially for each operator. Each new bulletin is recorded in this record when received and filed as instructed. A bulletin may not apply to all airplane models. In this case, the bulletin specifically identifies the airplane effectivity. When appropriate, the next formal FCOM revision will include an updated bulletin record page.

Bulletin status is defined as follows:

- **In Effect (IE)** – the bulletin contains pertinent information not otherwise covered in the Flight Crew Operations Manual. The bulletin remains active and should be retained in the manual
- **Incorporated (INC)** – the bulletin operating information has been incorporated into the Flight Crew Operations Manual. However, the bulletin remains active and should be retained in the manual
- **Cancelled (CANC)** – the bulletin is no longer active and should be removed from the Flight Crew Operations Manual. All bulletins previously cancelled are no longer listed in the Bulletin Record.

The person filing a new or revised bulletin should amend the Bulletin Record as instructed in the Administrative Information section of the bulletin. When a bulletin includes replacement pages for the Flight Crew Operations Manual or QRH, the included pages should be filed as instructed in the Flight Crew Operations Manual Information section of the bulletin.

**DO NOT USE FOR FLIGHT**  
**757 Flight Crew Operations Manual**

Number	Subject	Date	Status
TBC-1	All Flaps/Slats-Up Landing Procedure	May 17, 2007	IE
TBC-2	Autoland Status Annunciator (ASA) Annunciation Change During Coupled Approach	May 17, 2007	IE
TBC-3	B/CRS (Localizer Backcourse) Autopilot/Flight Director Anomaly With -105 Flight Control Computer Installed	May 17, 2007	IE
TBC-4	Brake Metering Valve Shaft Fracture	May 17, 2007	IE
TBC-5	CDU Page Changes During Engine Inoperative Operation	May 17, 2007	IE
TBC-6	Consecutive Conditional Altitude Waypoints Map Anomaly	May 17, 2007	IE
TBC-7	Dual FMC Restarts And Data Link Fail CDU Messages	May 17, 2007	IE
TBC-8	EICAS Indication Of Impending Engine Fuel Filter Bypass	May 17, 2007	IE
TBC-9	Engine Parameter Fluctuation	May 17, 2007	IE
TBC-10	Engine Stalls During Ground Operation	May 17, 2007	IE
TBC-11	Flight Management Computer (FMC) Anomaly During Descent Phase of Flight	May 17, 2007	IE
TBC-12	Flight Management Computer (FMC) Anomaly of Engine Indicating and Crew Alerting System (EICAS) Alert	May 17, 2007	IE
TBC-13	Flight Management Computer (FMC) Lockup Resulting from Flight Plan Route Uplink	May 17, 2007	IE
TBC-14	Flight Management Computer (FMC) Lockup Resulting from Internal Timer Anomaly	May 17, 2007	IE
TBC-15	FMC Alternate Airport Anomaly	May 17, 2007	IE

# DO NOT USE FOR FLIGHT

## 757 Flight Crew Operations Manual

Number	Subject	Date	Status
TBC-16	FMC Altitude Display Anomaly	May 17, 2007	IE
TBC-17	FMC Assumed Temperature Derate Anomaly	May 17, 2007	IE
TBC-18	FMC CDU Scratchpad Message "Enter IRS Position"	May 17, 2007	IE
TBC-19	FMC Engine Out (E/O) Standard Instrument Departure (SID)	May 17, 2007	IE
TBC-20	FMC Failure During VOR Remote Tuning	May 17, 2007	IE
TBC-21	FMC Holding Pattern Anomaly	May 17, 2007	IE
TBC-22	FMC VFR Approach Anomaly	May 17, 2007	IE
TBC-23	FMC VNAV Anomaly During Intermediate Level Off	May 17, 2007	IE
TBC-24	Heading Reference Switch Operation With -133 Flight Control Computers Installed	May 17, 2007	IE
TBC-25	Inadvertent Overspeed Protection Trip	May 17, 2007	IE
TBC-26	Incorrect Display of VREF On The ADI Speed Tape	May 17, 2007	IE
TBC-27	Interference Between Oxygen Mask Panel Door and Nosewheel Steering Tiller	May 17, 2007	IE
TBC-28	Invalid ILS Indication	May 17, 2007	IE
TBC-29	Loss Of FMC Operation	May 17, 2007	IE
TBC-30	Pegasus Flight Management Computer (FMC) VNAV Level Off Anomaly	May 17, 2007	IE
TBC-31	Pegasus FMC HSI Map Display Anomaly	May 17, 2007	IE
TBC-32	Pegasus-FMC Control and Display Unit (CDU) Anomaly	May 17, 2007	IE
TBC-33	RB211-535C Engine Surge	May 17, 2007	IE

**DO NOT USE FOR FLIGHT**  
**757 Flight Crew Operations Manual**

Number	Subject	Date	Status
TBC-34	RB211-535E4 Engine Rundown During Descent	May 17, 2007	IE
TBC-35	Spoilers - Inflight Deployment	May 17, 2007	IE
TBC-36	Uncommanded Autopilot Engagement, Flight Mode Changes, And IAS/MACH Window Speed Changes	May 17, 2007	IE
TBC-37	Uncommanded Autopilot Engagements Or Uncommanded Autoflight Mode Changes	May 17, 2007	IE
TBC-38	Uncommanded CDU Page Changes	May 17, 2007	IE
TBC-39	Unscheduled In Motion Brake Application	May 17, 2007	IE
TBC-40	VNAV Descent Through MCP Altitude	May 17, 2007	IE
TBC-41	VNAV Descent to Holding Altitude	May 17, 2007	IE
TBC-42	APU Automatic Shutdown At High Altitude	May 17, 2007	INC
TBC-43	VNAV PATH Altitude Overshoot	May 17, 2007	IE
TBC-44	Center Tank Fuel Pumps	May 17, 2007	IE
TBC-45	FMC Display of ATS Datalink Messages From Previous Flights	May 17, 2007	IE
TBC-46	Loss of Inertial Reference System (IRS) Input to RDMI/RMI During Standby Power Operation	May 17, 2007	INC
TBC-47 R1	Engine Indication Fluctuations	November 18, 2008	INC
TBC-48	Pegasus Flight Management Computer (FMC) Lock-Up Anomaly Due to Data-Bus Communications Failure	May 17, 2007	IE
TBC-49	Incorrect Turn Direction During a Standard Instrument Departure (SID)	May 17, 2007	IE

# DO NOT USE FOR FLIGHT

## 757 Flight Crew Operations Manual

Number	Subject	Date	Status
TBC-50	Performance Predictions Anomaly in Flight Management Computer (FMC) Product Improvement Package (PIP) and Pegasus Software Versions	May 17, 2007	IE
TBC-51	Pegasus Flight Management Computer (FMC) Departure Routing Anomaly	May 17, 2007	IE
TBC-52	Uncommanded Auxiliary Power Unit (APU) Shutdown Prior to Engine Start	May 17, 2007	IE
TBC-53 R1	Honeywell Flight Management Computer (FMC) Anomaly	November 27, 2007	IE
TBC-54	Missing Advisory-Level Message Logic in EICAS Computer P/N S242N701-1001 Operating Program Software (OPS) Version 6	March 10, 2008	IE
TBC-56	Performance Adjustments for Thrust Shortfall of PW2000 Series Powered Airplanes with Cutback Fan Blades Installed	July 27, 2009	IE
TBC-57	Replacement of STANDBY BUS OFF Quick Reference Handbook (QRH) Checklist.	December 23, 2009	INC

Intentionally  
Blank



# Flight Crew Operations Manual Bulletin for The Boeing Company

<b>The Boeing Company</b> <b>Seattle, Washington 98124-2207</b>	 <b>757</b>
--	--

**Number:** TBC-1

**IssueDate:** May 17, 2007

**Airplane Effectivity:** All Airplanes

**Subject:** All Flaps/Slats-Up Landing Procedure

**Reason:** This bulletin provides information informing flight crews of temporary recommended procedures for flap failures.

Information in this bulletin is recommended by The Boeing Company, but may not be FAA approved at the time of writing. In the event of conflict with the FAA approved Airplane Flight Manual (AFM), the AFM shall supersede. The Boeing Company regards the information or procedures described herein as having a direct or indirect bearing on the safe operation of this model airplane.

THE FOLLOWING PROCEDURE AND/OR INFORMATION IS EFFECTIVE UPON RECEIPT

## Background Information

A recent occurrence has identified an increase in airplane exposure to possible all flaps and slats up landing.

A circuit design feature was found that caused the flap and slat alternate arming switch contacts to be overloaded. This results in contact erosion and eventual contact failure. Should both the normal flap/slat extension system and alternate contracts fail, a flaps and slats up landing may result.

Engineering has determined corrective action and a service bulletin has been issued. The bulletin number is 757-27-0073 and is dated December 20, 1985.

## Operating Instructions

In the interim, pending incorporation of the service bulletin or production equivalent configuration, if a flaps up/slats up landing is necessary, the following procedure should be used:

ALL FLAPS/SLATS-UP LANDING

GROUND PROXIMITY OVERRIDE SWITCH . . . . .OVRD

-Use  $V_{REF 30} + 50$  knots for landing.

## **Administrative Information**

Insert this bulletin behind the Operations Manual Bulletin Record page in Volume 1 of your Operations Manual. Amend the Operations Manual Bulletin Record to show bulletin TBC-1 "In Effect" (IE).

This Operations Manual Bulletin will be canceled after Boeing is notified that all affected airplanes in the operators fleet have been modified by Boeing Service Bulletin 757-27-0073.

Please send all correspondence regarding Operations Manual Bulletins status to one of the following addresses:

Boeing Commercial Airplanes  
Commercial Aviation Services  
Attn: 757 Manager, Flight Technical Data  
P.O. Box 3707, M/C 20-89  
Seattle, Washington, 98124-2207 USA  
Telephone: (206) 662-4000  
Fax: (206) 662-4743





# Flight Crew Operations Manual Bulletin for The Boeing Company

The Boeing Company  
Seattle, Washington 98124-2207



**Number:** TBC-2

**IssueDate:** May 17, 2007

## **Airplane Effectivity: All Airplanes**

**Subject:** Autoland Status Annunciator (ASA) Annunciation Change During Coupled Approach

**Reason:** This bulletin provides information informing flight crews of temporary recommended procedures for coupled approach anomalies.

Information in this bulletin is recommended by The Boeing Company, but may not be FAA approved at the time of writing. In the event of conflict with the FAA approved Airplane Flight Manual (AFM), the AFM shall supersede. The Boeing Company regards the information or procedures described herein as having a direct or indirect bearing on the safe operation of this model airplane.

THE FOLLOWING PROCEDURE AND/OR INFORMATION IS EFFECTIVE UPON RECEIPT

## **Background Information**

During a test flight at Boeing, all three autopilot channels disconnected during a coupled approach. Analysis revealed that this condition is caused by an error introduced between the Flight Control Computers (FCC) during a power transfer. The error occurs if one source of electrical power fails after the LAND 3 annunciation appears during approach. During the power transfer, air data from the Air Data computers is interrupted. The time required for the electrical system to revert to normal, then re-isolate may exceed the limit allowed for interruption of air data, and result in loss of air data to one FCC for the duration of the approach.

As a result, an autopilot disconnect may occur during flare or during go-around. Service Bulletins 757-22-0024 and 757-22-0032R1 correct this anomaly. Disconnecting the autopilots causes the electrical system to revert to normal operations (non-isolated), and resets the autoland system and ASA to allow normal LAND 2 or LAND 3 operation on subsequent approaches.

## Operating Instructions

If, during an autopilot (coupled) approach, following the LAND 3 annunciation, the Autoland Status Annunciator (ASA) is observed to change to LAND 2, execute a manual landing on that approach (weather permitting), or execute a manual go-around.

If the approach is continued, the autopilot must be disconnected prior to landing.

If a go-around is accomplished, the autopilot must be disconnected prior to executing the go-around.

A subsequent autopilot (coupled) approach and landing may be conducted provided LAND 2 or LAND 3 remains annunciated on that approach.

---

## Administrative Information

Insert this bulletin behind the Operations Manual Bulletin Record page in Volume 1 of your Operations Manual. Amend the Operations Manual Bulletin Record to show bulletin TBC-2 "In Effect" (IE).

This Operations Manual Bulletin will be canceled after Boeing is notified that all affected airplanes in the operators fleet have been modified by Boeing Service Bulletins 757-22-0024 and 757-220032R1. Both Service Bulletins must be accomplished to cancel this bulletin.

Please send all correspondence regarding Operations Manual Bulletins status to one of the following addresses:

Boeing Commercial Airplanes  
Commercial Aviation Services  
Attn: 757 Manager, Flight Technical Data  
P.O. Box 3707, M/C 20-89  
Seattle, Washington, 98124-2207 USA  
Telephone: (206) 662-4000  
Fax: (206) 662-4743



# Flight Crew Operations Manual Bulletin for The Boeing Company

The Boeing Company  
Seattle, Washington 98124-2207



**Number:** TBC-3

**IssueDate:** May 17, 2007

## **Airplane Effectivity: All Airplanes**

**Subject:** B/CRS (Localizer Backcourse) Autopilot/Flight Director Anomaly  
With -105 Flight Control Computer Installed

**Reason:** This bulletin provides information informing flight crews of temporary recommended procedures flying backcourse approaches.

Information in this bulletin is recommended by The Boeing Company, but may not be FAA approved at the time of writing. In the event of conflict with the FAA approved Airplane Flight Manual (AFM), the AFM shall supersede. The Boeing Company regards the information or procedures described herein as having a direct or indirect bearing on the safe operation of this model airplane.

THE FOLLOWING PROCEDURE AND/OR INFORMATION IS EFFECTIVE UPON RECEIPT

## **Background Information**

The -105 Flight Control Computer (FCC) has an anomaly when flying a backcourse approach using the flight director and subsequently engaging an autopilot. If an autopilot is engaged after flight director localizer B/CRS capture, B/CRS may disengage and, depending upon course error, one of the following would occur: for course errors less than 60 degrees, the FCC's revert to HDG HLD and LOC mode arms; for course errors 60 degrees or greater, the FCC's revert to LOC mode and command a 30 degree bank turn to capture the localizer front course resulting in turning away from the backcourse localizer centerline.

The -106 FCC installed by Service Bulletin (757-22-0019) or production equivalent configuration (PRR 53868) corrects this anomaly.

## Operating Instructions

If the autopilot is to be used for a localizer back course, engage the autopilot prior to localizer B/CRS capture. In the event the autopilot is not engaged prior to B/CRS capture, the autopilot and both Flight Directors must be switched off. The autopilot may then be re-engaged if desired, prior to reselecting B/CRS. Operation of the flight director for backcourse localizer is not affected if the autopilot is not engaged.

---

## Administrative Information

Insert this bulletin behind the Operations Manual Bulletin Record page in Volume 1 of your Operations Manual. Amend the Operations Manual Bulletin Record to show bulletin TBC-3 "In Effect" (IE).

This Operations Manual Bulletin will be canceled after Boeing is notified that all affected airplanes in the operators fleet have been modified by Boeing Service Bulletin 757-22-0019.

Please send all correspondence regarding Operations Manual Bulletins status to one of the following addresses:

Boeing Commercial Airplanes  
Commercial Aviation Services  
Attn: 757 Manager, Flight Technical Data  
P.O. Box 3707, M/C 20-89  
Seattle, Washington, 98124-2207 USA  
Telephone: (206) 662-4000  
Fax: (206) 662-4743



# Flight Crew Operations Manual Bulletin for The Boeing Company

The Boeing Company  
Seattle, Washington 98124-2207



**Number:** TBC-4

**IssueDate:** May 17, 2007

**Airplane Effectivity:** All Airplanes

**Subject:** Brake Metering Valve Shaft Fracture

**Reason:** This bulletin provides information informing flight crews of temporary recommended procedures for braking anomalies.

Information in this bulletin is recommended by The Boeing Company, but may not be FAA approved at the time of writing. In the event of conflict with the FAA approved Airplane Flight Manual (AFM), the AFM shall supersede. The Boeing Company regards the information or procedures described herein as having a direct or indirect bearing on the safe operation of this model airplane.

THE FOLLOWING PROCEDURE AND/OR INFORMATION IS EFFECTIVE UPON RECEIPT

## Background Information

Two operators have reported four cases of partial loss of braking during taxi. In one of the cases, the crew reported one brake pedal to be very "spongy" with reduced braking effectiveness when compared to the other brake pedal. Subsequent troubleshooting of the incidents has determined that the loss of braking was due to brake metering valve actuation shaft fractures. The investigation has also revealed that the brake metering valve shaft fractures have occurred only on airplanes equipped with aluminum shafts. It was confirmed that fractured or sheared shafts could cause reduced or loss of braking to the affected gear.

The Auto braking system is not affected by a fractured or sheared shaft and could be selected to stop the airplane if conditions for auto brake operation are satisfied, i.e., speed above 60 knots, no manual braking (i.e. pilot's feet off the brake pedals), thrust levers in idle or reverse, and speedbrake lever has not been moved to down detent after speedbrakes have been deployed.

This condition will be corrected by installing steel brake metering valve actuation shafts on an expedited schedule.

## Operating Instructions

The following interim Operating Instructions are recommended:

- During taxi if a brake pedal feels "spongy" or if reduced, or loss of, braking to one gear occurs, the brake metering valve actuation shafts should be checked by maintenance personnel prior to flight.

---

## Administrative Information

Insert this bulletin behind the Operations Manual Bulletin Record page in Volume 1 of your Operations Manual. Amend the Operations Manual Bulletin Record to show bulletin TBC-4 "In Effect" (IE).

This Operations Manual Bulletin will be canceled after Boeing is notified that all affected airplanes in the operators fleet have been modified by Boeing Service Bulletin 757-32-0083.

Please send all correspondence regarding Operations Manual Bulletins status to one of the following addresses:

Boeing Commercial Airplanes  
Commercial Aviation Services  
Attn: 757 Manager, Flight Technical Data  
P.O. Box 3707, M/C 20-89  
Seattle, Washington, 98124-2207 USA  
Telephone: (206) 662-4000  
Fax: (206) 662-4743



# Flight Crew Operations Manual Bulletin for The Boeing Company

The Boeing Company  
Seattle, Washington 98124-2207



**Number:** TBC-5

**IssueDate:** May 17, 2007

## **Airplane Effectivity: All Airplanes**

**Subject:** CDU Page Changes During Engine Inoperative Operation

**Reason:** This bulletin provides information informing flight crews of temporary recommended procedures for determining the engine out cruise speed.

Information in this bulletin is recommended by The Boeing Company, but may not be FAA approved at the time of writing. In the event of conflict with the FAA approved Airplane Flight Manual (AFM), the AFM shall supersede. The Boeing Company regards the information or procedures described herein as having a direct or indirect bearing on the safe operation of this model airplane.

THE FOLLOWING PROCEDURE AND/OR INFORMATION IS EFFECTIVE UPON RECEIPT

## **Background Information**

The FMC operating programs listed immediately below will not allow the CDU display to automatically switch from ACT ENG OUT CRZ D/D to ACT ENG OUT CRZ following single engine driftdown unless VNAV is engaged. Selecting VNAV in single engine cruise will cause the CDU to display ACT ENG OUT CRZ.

### **Operating Programs**

PS4038713-112	PS4052520-150	PS4052520-170
PS4038713-113	PS4052520-151	PS4052520-178
PS4052520-140	PS4052520-158	PS4052970-940

## **Operating Instructions**

During engine inoperative operation, engine out LRC speed may be determined using the CDU if VNAV is engaged. IF VNAV is not engaged, use the QRH or other approved source to determine engine out long range cruise speed.

## **Administrative Information**

Insert this bulletin behind the Operations Manual Bulletin Record page in Volume 1 of your Operations Manual. Amend the Operations Manual Bulletin Record to show bulletin TBC-5 "In Effect" (IE).

This anomaly is corrected by Boeing Service Bulletin 757-34-0068.

Please send all correspondence regarding Operations Manual Bulletins status to one of the following addresses:

Boeing Commercial Airplanes  
Commercial Aviation Services  
Attn: 757 Manager, Flight Technical Data  
P.O. Box 3707, M/C 20-89  
Seattle, Washington, 98124-2207 USA  
Telephone: (206) 662-4000  
Fax: (206) 662-4743





# Flight Crew Operations Manual Bulletin for The Boeing Company

The Boeing Company  
Seattle, Washington 98124-2207



**Number:** TBC-6

**IssueDate:** May 17, 2007

## **Airplane Effectivity: All Airplanes**

**Subject:** Consecutive Conditional Altitude Waypoints Map Anomaly

**Reason:** To inform flight crews of an HSI Map display anomaly associated with routes containing two consecutive conditional altitude waypoints.

Information in this bulletin is recommended by The Boeing Company, but may not be FAA approved at the time of writing. In the event of conflict with the FAA approved Airplane Flight Manual (AFM), the AFM shall supersede. The Boeing Company regards the information or procedures described herein as having a direct or indirect bearing on the safe operation of this model airplane.

THE FOLLOWING PROCEDURE AND/OR INFORMATION IS EFFECTIVE UPON RECEIPT

## **Background Information**

During flight test, a Boeing flight crew experienced an HSI Map display anomaly. Simulator and lab tests show that when two consecutive conditional altitude waypoints exist in a procedure, the Map display of the magenta line does not reflect the intended path on the active leg for the conditional altitude waypoint. The displayed magenta line may erroneously indicate a turn prior to the airplane satisfying the required altitude for the turn. Conditional altitude waypoints are depicted as a small circle along with the altitude on the HSI Map display and their location depends on the airplane satisfying the altitude associated with the leg.

Consecutive conditional altitude waypoints may appear in Standard Instrument Departures (SID) and Missed Approach procedures and are automatically entered into the route when a procedure is selected from the FMC DEPARTURES or ARRIVALS page.

Procedures which use this combination of two consecutive altitude waypoints usually require a climb to a specified altitude followed by a small turn to intercept a VOR radial while climbing to a higher altitude. Approximately 400 procedures worldwide are affected by this anomaly.

Honeywell and Boeing are investigating this anomaly.

The typical HSI Map display and corresponding RTE LEGS page display for conditional altitude waypoints are shown below:

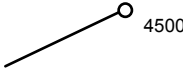
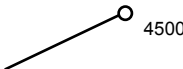
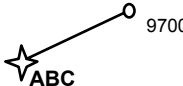
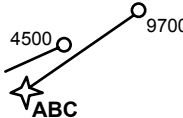
Description	ND Map Display	CDU LEGS Page Display
Constant Heading to an Altitude		070° HDG ( 4500)
Constant Course to an Altitude		070° TRK ( 4500)
Outbound Radial to an Altitude		070° ( 9700)
Consecutive Course to an Altitude Followed by Outbound Radial to an Altitude		070° TRK ( 4500) 063° ( 9700)

## Operating Instructions

When flying a SID or missed approach procedure containing consecutive conditional altitude waypoints, the active route shown on the HSI Map is incorrect; however, LNAV guidance is reliable and may be flown using either the flight director or autopilot. Monitor LNAV progress and insure all altitudes and turn points are consistent with the procedure and available raw data.

Three different vendors (Jeppesen, Swissair and Racal) supply navigation data bases for the FMC. Currently affected procedures for each vendor's navigation data base are contained in the original bulletin and are not reissued with this bulletin. To determine which vendor supplies your data base, check the Navigation Data Line on the FMC IDENT page. The navigation data base identifier begins with a three letter code. Use the attached Navigation Data Base vs. Vendor Reference Table (A) to determine the vendor associated with the three letter navigation data base identifier. Then locate the attached vendor tables (B1, B2 and B3) to determine the affected procedures.

## Administrative Information

Insert this bulletin behind the Operations Manual Bulletin Record page in Volume 1 of your Operations Manual. Amend the Operations Manual Bulletin Record to show bulletin TBC-6 "In Effect" (IE).

This anomaly will be corrected by Boeing Service Bulletin 757-34-0181. Other FMC's are corrected by Boeing Service Bulletin 757-34-0192 or 757-34-0210 or 757-34-0212. Refer to individual Service Bulletin for applicability.

Please send all correspondence regarding Operations Manual Bulletins status to one of the following addresses:

Boeing Commercial Airplanes  
Commercial Aviation Services  
Attn: 757 Manager, Flight Technical Data  
P.O. Box 3707, M/C 20-89  
Seattle, Washington, 98124-2207 USA  
Telephone: (206) 662-4000  
Fax: (206) 662-4743

**Operations Manual Bulletin Attachment**  
**Consecutive Conditional Altitude Waypoints Map Anomaly**

<b>Table A</b>							
<b>Navigation Data Base vs. Vendor Reference Table</b>							
<b>Nav. ID</b>	<b>Vendor</b>	<b>Nav. ID</b>	<b>Vendor</b>	<b>Nav. ID</b>	<b>Vendor</b>	<b>Nav. ID</b>	<b>Vendor*</b>
AA7	J	BA1	J	CI4	J	ET2	J
AC1	J	BB2	S	CI5	J	ET3	J
AC3	J	BE0	J	CJ1	J	ET4	J
AC4	J	BE3	J	CM2	J	ET6	J
AE1	S	BE4	J	CM3	J	EZ1	S
AE2	S	BE6	J	CO1	J	EZ2	S
AE3	S	BE7	J	CP1	J	FA1	J
AF4	S	BE8	J	CP4	J	FA2	J
AH3	J	BE9	J	CP9	J	FI1	J
AH6	J	BI1	J	CV1	S	FS1	J
AI4	J	BI6	J	CX4	J	FX1	J
AJ1	J	BI7	J	CZ5	J	GA5	S
AM1	J	BK1	J	CZ6	J	GB1	J
AM6	J	BK1	J	DL1	J	GB2	J
AN6	A	BO1	J	DL2	J	GD1	J
AR1	J	BO4	J	DL3	J	GF1	J
AR5	J	BR1	J	DL3	J	GF2	J
AT1	J	BR2	J	DL4	J	GF5	J
AT2	J	BY1	R	DL5	J	GG1	J
AT4	J	BY2	R	DP1	J	GS1	J
AV1	J	BY3	R	DP5	J	HE4	J
AW1	J	BY4	R	DP8	J	HP5	J
AW2	J	BY6	R	EE1	J	HV2	S
AY1	J	CA2	J	EK2	S	HV5	S
AY8	J	CA4	J	ER1	J	HV6	S
AZ8	S	CB2	J	ET1	J	HY6	S
AZ8	S	CB2	J	ET1	J	HY6	S

\*J = Jeppesen (Table B1) S = Swissair (Table B2) R = Racal (Table B3)

**Operations Manual Bulletin Attachment**  
**Consecutive Conditional Altitude Waypoints Map Anomaly**

Table A							
Navigation Data Base vs. Vendor Reference Table							
Nav. ID	Vendor	Nav. ID	Vendor	Nav. ID	Vendor	Nav. ID	Vendor*
IB1	S	LA2	J	MS5	J	PT4	R
IB3	S	LA6	J	MS6	J	PT5	R
IL5	J	LH4	S	MT1	J	PT6	R
IL6	J	LH5	S	MU1	J	QF1	J
JD7	J	LO1	J	MX1	J	QF4	J
JD9	J	LO6	J	MX4	J	QN2	J
JG4	J	LU1	S	NG6	J	QN3	J
JK1	S	LU3	S	NH1	J	QQ2	J
JK3	S	LU4	S	NH2	J	RA1	J
JL1	J	LU5	S	NH4	J	RG1	J
JL2	J	LU6	S	NH6	J	RG2	J
JL4	J	LU7	S	NS1	J	RS6	J
JL6	J	LY2	J	NS2	J	SA4	J
KE2	J	LY3	J	NS3	J	SA6	J
KE4	J	LY7	J	NU1	J	SE1	J
KF1	J	MA6	J	NW1	J	SI1	J
KF2	J	MD0	J	NW4	J	SK4	S
KF3	J	MD1	J	OZ1	J	SK5	S
KF4	J	MD2	J	OZ2	J	SK6	S
KL4	S	MD3	J	OZ4	J	SN7	S
KL5	S	MH1	S	PA1	S	SQ4	J
KL7	S	MH4	J	PL1	J	SR4	S
KT1	J	MJ1	J	PL2	J	SR5	S
KT2	J	MK1	J	PR4	J	ST1	J
KT6	J	MP2	S	PT1	J	SU6	J
KU6	S	MP5	S	PT2	J	SV5	J
LA1	J	MS1	J	PT3	J	TA1	J
*J = Jeppesen (Table B1) S = Swissair (Table B2) R = Racal (Table B3)							

**Operations Manual Bulletin Attachment**  
**Consecutive Conditional Altitude Waypoints Map Anomaly**

<b>Table A</b>							
<b>Navigation Data Base vs. Vendor Reference Table</b>							
<b>Nav. ID</b>	<b>Vendor</b>	<b>Nav. ID</b>	<b>Vendor</b>	<b>Nav. ID</b>	<b>Vendor</b>	<b>Nav. ID</b>	<b>Vendor*</b>
TA5	J	UK3	R	WE1	J		
TE4	J	UK6	S	WO2	J		
TE6	J	UN1	S	XG1	J		
TE7	J	UN2	S	XO2	S		
TG5	S	UN5	S	XO5	J		
TK2	J	UP1	J	XY1	S		
TQ2	S	UP3	J	YK1	J		
TQ3	S	UP5	J	YN1	J		
TR1	J	UP6	J	YX1	J		
TR2	J	US5	J	ZB1	R		
TR3	J	US6	J	ZB2	R		
TS1	J	UX1	J	ZB3	R		
TS2	J	UX2	J	ZB4	R		
TW1	J	UX3	J	ZO1	J		
TW2	J	VE1	J				
TW3	J	VE2	S				
TW4	J	VO1	S				
TZ1	J	VO3	S				
TZ2	J	VP1	S				
TZ3	J	VR1	J				
TZ4	J	VS4	S				
UA1	J	VZ1	J				
UA2	J	VZ2	J				
UA4	J	VZ4	J				
UC1	J	VZ5	J				
UD1	J	VZ6	J				
*J = Jeppesen (Table B1) S = Swissair (Table B2) R = Racal (Table B3)							

**Operations Manual Bulletin Attachment**  
**Consecutive Conditional Altitude Waypoints Map Anomaly**

<b>Table B1</b>			
<b>Jeppesen Navigation Data Base - Standard Instrument Departures</b>			
<b>ICAO ID</b>	<b>Airport</b>	<b>Departure</b>	<b>Runway</b>
EDFH	Hahn, Germany	RUWE1E	RW03
EHAM	Amsterdam,Schipol, Netherlands	EO01L	RW01L
EHAM	Amsterdam,Schipol, Netherlands	EO09L	RW09L
EHAM	Amsterdam,Schipol, Netherlands	EO27L	RW27L
ENBO	Bodo, Norway	GLOM2B	RW26
ENBO	Bodo, Norway	STOB1B	RW26
ENDU	Bardufoss, Norway	BDF2	RW11
ENDU	Bardufoss, Norway	LAVN2A	RW11
ENDU	Bardufoss, Norway	TULD2A	RW11
ENZV	Stavanger/Sola, Norway	BANK1D	RW29
ENZV	Stavanger/Sola, Norway	DOG11D	RW11
ENZV	Stavanger/Sola, Norway	DOLF1D	RW29
ENZV	Stavanger/Sola, Norway	FUND1D	RW29
ENZV	Stavanger/Sola, Norway	GRAM1D	RW11
ENZV	Stavanger/Sola, Norway	LUCK1D	RW29
ENZV	Stavanger/Sola, Norway	MADY1D	RW11
ENZV	Stavanger/Sola, Norway	OKLA1D	RW11
ENZV	Stavanger/Sola, Norway	SIRD1D	RW11
ENZV	Stavanger/Sola, Norway	STON1D	RW29
ESNN	Sundsvall-Harnosand, Sweden	LUE1C	RW34
ESNN	Sundsvall-Harnosand, Sweden	STEW2C	RW34
FACT	Cape Town, South Africa	OKTE2B	RW19
FACT	Cape Town, South Africa	PARI2B	RW19
GCFV	Fuerteventura, Canary Is	KORA1R	RW19
GCFV	Fuerteventura, Canary Is	LPC2R	RW19
GCFV	Fuerteventura, Canary Is	LT1R	RW19
GCFV	Fuerteventura, Canary Is	SAMA1R	RW19
GCFV	Fuerteventura, Canary Is	TFN1R	RW19

**Operations Manual Bulletin Attachment**  
**Consecutive Conditional Altitude Waypoints Map Anomaly**

<b>Table B1</b>			
<b>Jeppesen Navigation Data Base - Standard Instrument Departures</b>			
<b>ICAO ID</b>	<b>Airport</b>	<b>Departure</b>	<b>Runway</b>
GCFV	Fuerteventura, Canary Is	TFS2R	RW19
GCFV	Fuerteventura, Canary Is	VAST1R	RW19
KBZN	Boseman/Gallatin, MT	BZN365	RW30
KBZN	Boseman/Gallatin, MT	BZN86S	RW30
KBZN	Boseman/Gallatin, MT	BZN86W	RW30
KCGZ	Casa-Grande, AZ	UCZKJ1	RW05
KHLN	Helena, MT	HLN2	RW05
KHLN	Helena, MT	HLN2	RW09
KINW	Winslow, AZ	HLN1	RW29
KLAX	Los Angeles, CA	BEVAN1	ALL
KMSO	Missoula, MT	MSOEAS	RW29
KPHX	Phoenix/Sky Harbor, AZ	MISSY2	RW26B
KSJC	San Jose, CA	SUNOL5	RW12
KSTS	Santa Rosa/Sonoma Co, CA	STS5	RW01
KSTS	Santa Rosa/Sonoma Co, CA	STS5	RW14
KSTS	Santa Rosa/Sonoma Co, CA	STS5	RW19
KSTS	Santa Rosa/Sonoma Co, CA	STS5	RW32
LEAS	Asturias, Spain	ARPO1B	RW11
LEAS	Asturias, Spain	LURI1B	RW11
LEAS	Asturias, Spain	MUSI1B	RW11
LEAS	Asturias, Spain	RATP1B	RW11
LEIB	Ibza, Spain	MHN1E	RW24
LEIB	Ibza, Spain	MJV1E	RW24
LEPA	Palma de Mallorca, Spain	MEBU1A	RW24
LEPA	Palma de Mallorca, Spain	MHN1A	RW24
LEPA	Palma de Mallorca, Spain	MJV1B	RW06
LEPA	Palma de Mallorca, Spain	OSGA1A	RW24
LFMI	Istres/Le Tube, France	LUC6D	RW15



**Operations Manual Bulletin Attachment**  
**Consecutive Conditional Altitude Waypoints Map Anomaly**

<b>Table B1</b>			
<b>Jeppesen Navigation Data Base - Standard Instrument Departures</b>			
<b>ICAO ID</b>	<b>Airport</b>	<b>Departure</b>	<b>Runway</b>
LGAT	Athens, Greece	FALC1F	RW15
LGAT	Athens, Greece	KOR1F	RW15
LGAT	Athens, Greece	KRS1F	RW15
LGAT	Athens, Greece	TNG1F	RW15
LGAT	Athens, Greece	VIL11F	RW15
LGKL	Kalamata, Greece	KLM1V	RW17
LGKL	Kalamata, Greece	KLM1Y	RW17
LGKP	Karpathos, Greece	KRC1A	RW30
LGKP	Karpathos, Greece	KRC1B	RW12
LGKV	Kavala/Megas Alexandros, Greece	ALX3A	RW05
LGKV	Kavala/Megas Alexandros, Greece	ALX3B	RW23
LGKV	Kavala/Megas Alexandros, Greece	LMO3A	RW05
LGKV	Kavala/Megas Alexandros, Greece	LMO3B	RW23
LGKV	Kavala/Megas Alexandros, Greece	PERE3A	RW05
LGKV	Kavala/Megas Alexandros, Greece	RODO1A	RW05
LGKV	Kavala/Megas Alexandros, Greece	RODO1B	RW23
LGMK	Mikonos, Greece	RIPL1A	RW34
LGMK	Mikonos, Greece	RIPL1B	RW16
LGMT	Mitilini, Greece	LSV1A	RW33
LGRX	Araxos, Greece	ALAK1M	RW36
LGRX	Araxos, Greece	ARGU1M	RW36
LGRX	Araxos, Greece	IXON1M	RW36
LGRX	Araxos, Greece	KESA1M	RW36
LGRX	Araxos, Greece	KOR1M	RW36
LGRX	Araxos, Greece	KRK1M	RW36
LGRX	Araxos, Greece	TRL1M	RW36
LGSR	Santorini, Greece	AST11E	RW16
LGSR	Santorini, Greece	ATLA1B	RW34

**Operations Manual Bulletin Attachment**  
**Consecutive Conditional Altitude Waypoints Map Anomaly**

<b>Table B1</b>			
<b>Jeppesen Navigation Data Base - Standard Instrument Departures</b>			
<b>ICAO ID</b>	<b>Airport</b>	<b>Departure</b>	<b>Runway</b>
LGSR	Santorini, Greece	ATLA1C	RW16
LGSR	Santorini, Greece	MIL1E	RW34
LGSR	Santorini, Greece	MIL1F	RW34
LGSR	Santorini, Greece	MIL1G	RW16
LGSR	Santorini, Greece	MIL1H	RW16
LGTG	Tanagra, Greece	AGH1C	RW28
LGTG	Tanagra, Greece	AGH1D	RW10
LGTG	Tanagra, Greece	ATH1C	RW28
LGTG	Tanagra, Greece	ATH1D	RW10
LGTG	Tanagra, Greece	IXON1C	RW28
LGTG	Tanagra, Greece	IXON1D	RW10
LGTG	Tanagra, Greece	OLID1C	RW28
LGTG	Tanagra, Greece	OLID1D	RW10
LGTG	Tanagra, Greece	SKL1F	RW28
LGTG	Tanagra, Greece	SKL1G	RW10
LGTS	Thessaloniki/Makedonia, Greece	ARNA1E	RW28
LGTS	Thessaloniki/Makedonia, Greece	FSK1E	RW28
LGTS	Thessaloniki/Makedonia, Greece	LAMB1E	RW28
LGTS	Thessaloniki/Makedonia, Greece	LOPO1E	RW28
LGTS	Thessaloniki/Makedonia, Greece	SKL1E	RW28
LGTS	Thessaloniki/Makedonia, Greece	TSL1F	RW28
LIBC	Crotone, Italy	CDC5A	RW35
LIBC	Crotone, Italy	CDC5B	RW17
LIMP	Parma, Italy	PAR5V	RW02
LIPZ	Venezia/Tessera, Italy	CHI5H	RW22
LIPZ	Venezia/Tessera, Italy	RON5H	RW22
LIPZ	Venezia/Tessera, Italy	ROTA5H	RW22
LIRQ	Florence, Italy	PIS5A	RW23

**Operations Manual Bulletin Attachment**  
**Consecutive Conditional Altitude Waypoints Map Anomaly**

<b>Table B1</b>			
<b>Jeppesen Navigation Data Base - Standard Instrument Departures</b>			
<b>ICAO ID</b>	<b>Airport</b>	<b>Departure</b>	<b>Runway</b>
LSGC	Les Eplatures, Switzerland	FRI1B	RW24
LSGC	Les Eplatures, Switzerland	HOC1A	RW24
LSGC	Les Eplatures, Switzerland	HOC1B	RW24
LSGC	Les Eplatures, Switzerland	SPR1B	RW24
LSZG	Grenchen, Switzerland	SHU2T	RW25
LSZG	Grenchen, Switzerland	WIL2T	RW25
MGGT	Guatemala/La Aurora, Guatemala	SJOB	RW01
MGGT	Guatemala/La Aurora, Guatemala	PALEN	RW01
MKJP	Kingston/Norman Manley, Jamaica	MLY1	RW12
MUCU	Santiago de Cuba/Antonio Maceo, Cuba	CAOBA2	RW09
NFNA	Nausori, Fiji	ALFA	RW10
NFNA	Nausori, Fiji	BRAVO	RW10
NFNA	Nausori, Fiji	BRAVO	RW28
NFNA	Nausori, Fiji	CHARLI	RW10
NSFA	Apia/Faleolo, Samoa	ALFA	RW26
NTAA	Tahiti, Tahiti	EMIR1A	RW04
NTAA	Tahiti, Tahiti	KAIN1A	RW04
NTAA	Tahiti, Tahiti	METU1A	RW04
OIAW	Ahwaz, Iran	GABK1B	RW30
OIAW	Ahwaz, Iran	GABK1H	RW12
OIAW	Ahwaz, Iran	MIS1B	RW30
OIAW	Ahwaz, Iran	MIS1H	RW12
OIBB	Bushehr, Iran	KUGV1A	RW31
OIBB	Bushehr, Iran	KUGV1B	RW13
OIBB	Bushehr, Iran	KUGV1C	RW31
OICC	Kermanshah, iran	RULI1D	RW11
OIGG	Rasht, Iran	RALG1A	RW27
OIGG	Rasht, Iran	RALG1B	RW09

**Operations Manual Bulletin Attachment**  
**Consecutive Conditional Altitude Waypoints Map Anomaly**

<b>Table B1</b>			
<b>Jeppesen Navigation Data Base - Standard Instrument Departures</b>			
<b>ICAO ID</b>	<b>Airport</b>	<b>Departure</b>	<b>Runway</b>
OIGG	Rasht, Iran	RART1A	RW27
OIGG	Rasht, Iran	RART1B	RW09
OIKB	Bandar Abbass, Iran	TAVN2A	RW03
OIKK	Kerman, Iran	ALGU2B	RW34
OIKK	Kerman, Iran	ALGU2D	RW34
OIKK	Kerman, Iran	ALGU2E	RW34
OIKK	Kerman, Iran	ALGU3A	RW34
OIKK	Kerman, Iran	ALGU3C	RW16
OIKK	Kerman, Iran	ALKE2C	RW34
OIKK	Kerman, Iran	ALKE3A	RW34
OIKK	Kerman, Iran	ALKE3B	RW16
OIKK	Kerman, Iran	ALKU2D	RW34
OIKK	Kerman, Iran	ALKU2E	RW16
OIKK	Kerman, Iran	ALKU3A	RW34
OIKK	Kerman, Iran	ALKU3B	RW16
OIKK	Kerman, Iran	ALKU3C	RW16
OIKK	Kerman, Iran	ALME2D	RW34
OIKK	Kerman, Iran	ALME3A	RW34
OIKK	Kerman, Iran	ALME3C	RW16
OIKK	Kerman, Iran	ALMI2A	RW34
OIKK	Kerman, Iran	ALMI2B	RW16
OIKK	Kerman, Iran	ALMI2C	RW16
OIKK	Kerman, Iran	ALMI2D	RW34
OIKK	Kerman, Iran	ALMO1A	RW34
OIKK	Kerman, Iran	ALMO2B	RW34
OIKK	Kerman, Iran	ALMO2C	RW16
OIKK	Kerman, Iran	ALMO2D	RW34
OIKK	Kerman, Iran	ALMO2E	RW34

**Operations Manual Bulletin Attachment**  
**Consecutive Conditional Altitude Waypoints Map Anomaly**

<b>Table B1</b>			
<b>Jeppesen Navigation Data Base - Standard Instrument Departures</b>			
<b>ICAO ID</b>	<b>Airport</b>	<b>Departure</b>	<b>Runway</b>
OIMM	Mashhad, Iran	METK2A	RW13
OIMM	Mashhad, Iran	METK2B	RW31
OIMM	Mashhad, Iran	METK2C	RW31
OIMM	Mashhad, Iran	MIDM1A	RW13
OIMM	Mashhad, Iran	MIDM1B	RW31
OIMM	Mashhad, Iran	NOTS2A	RW13
OIMM	Mashhad, Iran	NOTS2B	RW13
OIMM	Mashhad, Iran	NOTS2C	RW31
OIMM	Mashhad, Iran	RAMI2A	RW13
OIMM	Mashhad, Iran	RAMI2B	RW31
OISS	Shiraz, Iran	KISE1B	RW11
OITR	Uromiyeh, Iran	BONA1B	RW21
OITR	Uromiyeh, Iran	ZAJ1B	RW21
OITT	Tabriz, Iran	RUDA1B	RW12
OITT	Tabriz, Iran	RUDA1D	RW12
OIZH	Zaheadan, Iran	DANO2B	RW17
OLBA	Beirut, Lebanon	KAD1C	RW18
OLBA	Beirut, Lebanon	KAD1C	RW21
RJCH	Hakodate, Japan	HWE2R	RW12
RJCN	Nakashibetsu, Japan	NSE2R	RW26
RJFE	Fukue, Japan	FUER1	RW21
RJFE	Fukue, Japan	JB2	RW03
RJFE	Fukue, Japan	OLE2	RW03
RJFY	Kanoya, Japan	EASTRE	RW08
RJFY	Kanoya, Japan	WESTRE	RW26
RJKA	Amami, Japan	AME1R	RW03
RJKA	Amami, Japan	AME1R	RW21
RJOB	Okayama, Japan	OKC2	RW07

**Operations Manual Bulletin Attachment**  
**Consecutive Conditional Altitude Waypoints Map Anomaly**

<b>Table B1</b>			
<b>Jeppesen Navigation Data Base - Standard Instrument Departures</b>			
<b>ICAO ID</b>	<b>Airport</b>	<b>Departure</b>	<b>Runway</b>
RJOB	Okayama, Japan	OYE2R	RW07
RJOB	Okayama, Japan	WASYU1	RW07
RJOC	Izumo, Japan	OIE2	RW07
RJOC	Izumo, Japan	TRE4	RW07
RJOC	Izumo, Japan	XZE1R	RW07
RJOC	Izumo, Japan	XZE3E	RW07
RJOW	Iwami, Japan	IME1R	RW29
RJSA	Aomori, Japan	MRE1R	RW06
RJSA	Aomori, Japan	MRE1R	RW24
RJSF	Fukushima, Japan	GTC1	RW19
RJSF	Fukushima, Japan	SDE1	RW19
RJSF	Fukushima, Japan	YTE1	RW19
RJSY	Shonai, Japan	YSE1R	RW27
RJTH	Hachliojima, Japan	HCE1R	RW25
RJTH	Hachliojima, Japan	HCE2W	RW25
RJTO	Oshma, Japan	MJ1	RW21
RJTO	Oshma, Japan	SPENS2	RW03
RKJY	Yeosu, Korea	GOSB1A	RW17
RKJY	Yeosu, Korea	NIKE1A	RW17
ROAH	Naha, Japan	NHC2SR	RW18
RPMD	Davao/Francisco Bangoy, Phillipines	SID1B	RW23
RPMD	Davao/Francisco Bangoy, Phillipines	SID2	RW23
RPMD	Davao/Francisco Bangoy, Phillipines	SID3	RW23
RPMD	Davao/Francisco Bangoy, Phillipines	SID4	RW23
RPMZ	Zamboanga, Phillipines	SID1	RW09
RPMZ	Zamboanga, Phillipines	SID1	RW27
RPMZ	Zamboanga, Phillipines	SID2	RW09
RPMZ	Zamboanga, Phillipines	SID2	RW27

**Operations Manual Bulletin Attachment**  
**Consecutive Conditional Altitude Waypoints Map Anomaly**

<b>Table B1</b>			
<b>Jeppesen Navigation Data Base - Standard Instrument Departures</b>			
<b>ICAO ID</b>	<b>Airport</b>	<b>Departure</b>	<b>Runway</b>
RPMZ	Zamboanga, Phillipines	SID7	RW09
RPMZ	Zamboanga, Phillipines	SID7	RW27
RPVM	Lapu-Lapu/Mactan, Phillipines	SID15	RW04
RPVM	Lapu-Lapu/Mactan, Phillipines	SID15A	RW04
RPVM	Lapu-Lapu/Mactan, Phillipines	SID16	RW04
SCFA	Antofagasta, Chile	ANCLA2	RW18
SCFA	Antofagasta, Chile	ANCLA3	RW19
SCFA	Antofagasta, Chile	COLOSB	RW18
SCFA	Antofagasta, Chile	COLOSC	RW19
SCFA	Antofagasta, Chile	MOREK1	RW18
SCFA	Antofagasta, Chile	MOREK2	RW19
SCIE	Concepcion/Carriel, Chile	CORNLA	RW20
SCSE	La Serena/La Florida, Chile	LILEN1	RW29
SVCS	Charallave/Oscar Machado Zuoloaga, Venezuela	3NOL10	RW10
ZYTL	Dalian, China	D15T	RW28

**Operations Manual Bulletin Attachment**  
**Consecutive Conditional Altitude Waypoints Map Anomaly**

<b>Table B1</b>		
<b>Jeppesen Navigation Data Base - Approaches/Missed Approaches</b>		
<b>ICAO ID</b>	<b>Airport</b>	<b>Approach</b>
CYDN	Dauphin, Manitoba, Canada	VOR14
CYXE	Saskatoon, Sask., Canada	VOR33
CYYB	North Bay, Ontario, Canada	VOR18
ENAT	Alta, Norway	ILS12
ENBO	Bodo, Norway	ILS08
ENKB	Kristiansund/Kvernberget, Norway	VOR25
FADN	Durban/Louis Botha, South Africa	VOR23
FYWH	Windhoek/Lughawe, Nambia	VOR26
GCCR	Arrecife/Lanzarote, Canary Is.	ILS04
KAHN	Athens/Ben Epps, GA	VOR02
KALW	Walla Walla, WA	VOR02
KBKE	Baker, OR	VOR12
KBLH	Blythe, CA	VOR26
KBOI	Boise, ID	VOR10R
KBOI	Boise, ID	ILS10R
KBPI	Big Piney/Marbleton, WY	VOR31
KCEC	Crescent City, CA	VOR11
KCEC	Crescent City, CA	ILS11
KCEC	Crescent City, CA	VOR11
KCMA	Camarillo, CA	VOR26
KCOE	Coeur D'alene, ID	VOR01
KCOE	Coeur D'alene, ID	ILS05
KDLF	Del Rio, TX	VOR13C
KDLF	Del Rio, TX	VOR31C
KDRO	Durango/La Plata Co., CO	VOR02
KDRO	Durango/La Plata Co., CO	ILS02
KEEO	Meeker, CO	RNV03
KFLG	Flagstaff, Puliam, AZ	VOR21



**Operations Manual Bulletin Attachment**  
**Consecutive Conditional Altitude Waypoints Map Anomaly**

<b>Table B1</b>		
<b>Jeppesen Navigation Data Base - Approaches/Missed Approaches</b>		
<b>ICAO ID</b>	<b>Airport</b>	<b>Approach</b>
KGFK	Grand Forks, ND	VOR17R
KGFK	Grand Forks, ND	VOR35L
KHVR	Havre City-Co, MT	VOR07
KHYS	Hays, KS	VOR16
KHYS	Hays, KS	VOR34
KHYS	Hays, KS	VOR16
KHYS	Hays, KS	VOR34
KIGM	Kingman, AZ	VOR21
KJAC	Jackson Hole, WY	ILS18
KLMT	Klamath Falls, OR	VOR32
KLMT	Klamath Falls, OR	ILS32
KNGP	Corpus Christi, TX	VOR13R
KNQX	Key West, FL	VOR07
KONA	Winona Muni/Max Conrad, MN	VOR29
KOTH	North Bend Muni, OR	VOR04
KPMD	Palmdale, CA	VOR25
KPMD	Palmdale, CA	ILS25
KPNE	North Philadelphia, PA	VOR24
KPUC	Price/Carbon Co, UT	VOR36
KRWL	Rawlins Muni, WY	VOR22
KSBM	Sheboygan Co, WI	VOR03
KSBY	Salisbury/Wicomico Co., MD	ILS32
KSBY	Salisbury/Wicomico Co., MD	VOR14
KSBY	Salisbury/Wicomico Co., MD	VOR32
KSVC	Silver City/Grant Co, NM	LOC26
KSVN	Savannah/Hunter, GA	VOR28
KTMA	Tifton, GA	VOR27
KTMA	Tifton, GA	VOR33

**Operations Manual Bulletin Attachment**  
**Consecutive Conditional Altitude Waypoints Map Anomaly**

<b>Table B1</b>		
<b>Jeppesen Navigation Data Base - Approaches/Missed Approaches</b>		
<b>ICAO ID</b>	<b>Airport</b>	<b>Approach</b>
KTRM	Palm Springs Thermal, CA	VOR30
KTVF	Thief River Falls, MN	VOR31
KTWF	Twin Falls/Sun Valley, ID	VOR07
LEBL	Barcelona, Spain	VOR02
LEBL	Barcelona, Spain	ILS07
LGKO	Marathon/Kotroni, Greece	VOR15
LGKO	Marathon/Kotroni, Greece	VOR33
LIPE	Bologna/Borgo Panigale, Italy	VOR12
LIPE	Bologna/Borgo Panigale, Italy	ILS12
LTAQ	Samsun, Turkey	VOR21
MDBH	Barahona, Dominican Republic	VOR12
MDBH	Barahona, Dominican Republic	VOR30
MDPP	Puerto Plata, Dominican Republic	VOR26
MDSO	Santo Domingo/De Las Americas, Dominican Republic	VOR17
MDSO	Santo Domingo/De Las Americas, Dominican Republic	VOR35
MHTG	Tegucigalpa/Toncontin, Honduras	VOR01
MPDA	David/Enrique Malek, Panama	VOR04
MPTO	Panama/Tocumen, Panama	VOR03L
MUCU	Santiago de Cuba/Antonio Maceo, Cuba	ILS09
MUCU	Santiago de Cuba/Antonio Maceo, Cuba	LOC09
NCRG	Avarua/Rarotonga, Cook Is.	ILS08
NCRG	Avarua/Rarotonga, Cook Is.	ILS26
NSFA	Faleolo, Samoa	ILS08
NZNR	Napier, New Zealand	VOR16
OEBH	Bisha, Saudi Arabia	ILS18
OEDR	Dhahran, Saudi Arabia	VOR34L
OEDR	Dhahran, Saudi Arabia	ILS34L

**Operations Manual Bulletin Attachment**  
**Consecutive Conditional Altitude Waypoints Map Anomaly**

<b>Table B1</b>		
<b>Jeppesen Navigation Data Base - Approaches/Missed Approaches</b>		
<b>ICAO ID</b>	<b>Airport</b>	<b>Approach</b>
OIBJ	Jam Tohid, Iran	VOR11
OIBJ	Jam Tohid, Iran	ILS11
OIFM	Esfahan, Iran	VOR26L
OIFM	Esfahan, Iran	VOR26R
PABI	Delta Junction, AK	VOR18
PAMC	McGrath, AK	VOR16
PAYA	Yakutat, AK	VOR11
PAYA	Yakutat, AK	VOR29
PHTO	Hilo, Hawaii	ILS26
RJBD	Nanki-Shirahama, Japan	VOR15
RJBD	Nanki-Shirahama, Japan	LOC15
RJCB	Obhiro, Japan	ILS35
RJCH	Hakodate, Japan	VOR12
RJCH	Hakodate, Japan	ILS12
RJCH	Hakodate, Japan	LOC12
RJCM	Memambetsu, Japan	ILS18
RJDC	Yamaguchi-Ubi/Honshu Is., Japan	VOR07
RJDT	Tsushima, Japan	LOC32
RJDT	Tsushima, Japan	VOR32
RJFK	Kagoshima, Japan	VOR34
RJFK	Kagoshima, Japan	ILS34
RJKB	Okierabu, Japan	VOR22
RJKN	Tokunoshima Is., Japan	VOR01
RJNT	Toyama, Japan	LOC20
RJOB	Okayama, Japan	ILS07
RJOM	Matsuyama, Japan	ILS14
RJOR	Tottori, Japan	ILS10
RJOS	Tokushima, Japan	VOR29

**Operations Manual Bulletin Attachment**  
**Consecutive Conditional Altitude Waypoints Map Anomaly**

<b>Table B1</b>		
<b>Jeppesen Navigation Data Base - Approaches/Missed Approaches</b>		
<b>ICAO ID</b>	<b>Airport</b>	<b>Approach</b>
RJSF	Fukushima, Japan	ILS01
RJSF	Fukushima, Japan	VOR01
RJSF	Fukushima, Japan	VOR19
RJSN	Nigata, Japan	VOR10
RJSN	Nigata, Japan	VOR28
RJSN	Nigata, Japan	ILS28
RJSY	Shonai, Japan	VOR27
RJSY	Shonai, Japan	VOR09
RKPK	Kimhae, Korea	VOR36
ROMY	Miyako, Japan	ILS22
ROMY	Miyako, Japan	VOR04
ROMY	Miyako, Japan	VOR22
RORY	Yoron, Japan	VOR14
RORY	Yoron, Japan	VOR32
RPLL	Manila, Phillipines	VOR06
RPLL	Manila, Phillipines	ILS06
RPMD	Davao/Francisco Bangoy, Phillipines	VOR23
RPMD	Davao/Francisco Bangoy, Phillipines	VOR05
RPVA	Tacloban/Daniel Z. Romualdez, Phillipines	VOR36
RPVB	Bacolod Negros Occidental, Phillipines	VOR04
SBFL	Florianopolis/Hercilioluz, Brazil	VOR32
SBUP	Castilho/Urubupunga, Brazil	VOR29
SLVR	Viru Viru, Bolivia	ILS33
SPIM	Lima-Callao, Peru	VOR33
TGPY	Point Salines, GranaVORa	VOR10
VAGO	Goa, India	VOR08
VOMM	Madras, India	VOR12
VOMM	Madras, India	VOR30

**Operations Manual Bulletin Attachment  
Consecutive Conditional Altitude Waypoints Map Anomaly**

<b>Table B1</b>		
<b>Jeppesen Navigation Data Base - Approaches/Missed Approaches</b>		
<b>ICAO ID</b>	<b>Airport</b>	<b>Approach</b>
VTBU	Rayong/Utapao, Thailand	VOR18
VTSB	Surat Thani, Thailand	VOR22
VTUW	Nakon Phanom, Thailand	VOR15
WAAU	Kendari/Wolter Monginsidi, Indonesia	VOR26
WAMM	Manado/Sam Ratulangi, India	ILS36
WAPP	Ambon/Patimura, Indonesia	ILS04
WRLL	Balikpapan/Sepinggan, Indonesia	ILS25
YMAY	Albury, Australia	VOR07
ZGNN	Nanning/Wuxu, China	VOR23

**Operations Manual Bulletin Attachment**  
**Consecutive Conditional Altitude Waypoints Map Anomaly**

<b>Table B2</b>			
<b>Swissair Navigation Data Base - Standard Instrument Departures</b>			
<b>Origin Airport</b>	<b>Airport Name</b>	<b>FMC-CDU Departure</b>	<b>FMC-CDU Runway</b>
EDFH	Hahn, Germany	RUWE1E	RW03
GCFV	Fuerteventura, Canary Is	KORA1R	RW19
GCFV	Fuerteventura, Canary Is	LPC1R	RW19
GCFV	Fuerteventura, Canary Is	LPC2R	RW19
GCFV	Fuerteventura, Canary Is	LT1R	RW19
GCFV	Fuerteventura, Canary Is	SAMA1R	RW19
GCFV	Fuerteventura, Canary Is	TFN1R	RW19
GCFV	Fuerteventura, Canary Is	TFS2R	RW19
GCFV	Fuerteventura, Canary Is	VAST1R	RW19
HKJK	Nairobi/Jomo Kenyatta, Kenya	LADANC	RW06
KHLN	Helena, MT	HLN2	RW05
KHLN	Helena, MT	HLN2	RW09
KSJC	San Jose, CA	ALTAM6	RW12
KSJC	San Jose, CA	SUNOL5	RW12
LEAS	Asturias, Spain	ARPO1A	RW29
LEAS	Asturias, Spain	ARPO1B	RW11
LEAS	Asturias, Spain	LURI1A	RW29
LEAS	Asturias, Spain	LURI1B	RW11
LEAS	Asturias, Spain	MUSI1A	RW29
LEAS	Asturias, Spain	MUSI1B	RW11
LEAS	Asturias, Spain	RATP1A	RW29
LEAS	Asturias, Spain	RATP1B	RW11
LEIB	Ibza, Spain	EO24	RW24
LEIB	Ibza, Spain	MHN1E	RW24
LEIB	Ibza, Spain	MJV1E	RW24
LEPA	Palma de Mallorca, Spain	MEBU1A	RW24
LEPA	Palma de Mallorca, Spain	MHN1A	RW24

**Operations Manual Bulletin Attachment**  
**Consecutive Conditional Altitude Waypoints Map Anomaly**

<b>Table B2</b>			
<b>Swissair Navigation Data Base - Standard Instrument Departures</b>			
<b>Origin Airport</b>	<b>Airport Name</b>	<b>FMC-CDU Departure</b>	<b>FMC-CDU Runway</b>
LEPA	Palma de Mallorca, Spain	MJV1B	RW06
LEPA	Palma de Mallorca, Spain	OSGA1A	RW24
LGAT	Athens, Greece	KEA1D	RW33
LGAT	Athens, Greece	KRS1D	RW33
LGAT	Athens, Greece	TNG1D	RW33
LGAT	Athens, Greece	VIL1F	RW15
LGSK	Skiathos, Greece	AGH1A	RW20
LGSK	Skiathos, Greece	AGH1B	RW02
LGSK	Skiathos, Greece	KORS1A	RW20
LGSK	Skiathos, Greece	KORS1B	RW02
LGSK	Skiathos, Greece	TNG1A	RW20
LGSK	Skiathos, Greece	TNG1B	RW02
LGSK	Skiathos, Greece	TSL1A	RW20
LGSK	Skiathos, Greece	TSL1B	RW02
LGTG	Tanagra, Greece	AGH1C	RW28
LGTG	Tanagra, Greece	AGH1D	RW10
LGTG	Tanagra, Greece	ATH1C	RW28
LGTG	Tanagra, Greece	ATH1D	RW10
LGTG	Tanagra, Greece	IXON1C	RW28
LGTG	Tanagra, Greece	IXON1D	RW10
LGTG	Tanagra, Greece	OLID1C	RW28
LGTG	Tanagra, Greece	OLID1D	RW10
LGTG	Tanagra, Greece	SKL1F	RW28
LGTG	Tanagra, Greece	SKL1G	RW10
LGTS	Thessaloniki/Makedonia, Greece	EO28	RW28
LGTS	Thessaloniki/Makedonia, Greece	EO34	RW34
LGTS	Thessaloniki/Makedonia, Greece	TSL1F	RW28
LIBC	Crotone, Italy	CDC5A	RW35

**Operations Manual Bulletin Attachment**  
**Consecutive Conditional Altitude Waypoints Map Anomaly**

<b>Table B2</b>			
<b>Swissair Navigation Data Base - Standard Instrument Departures</b>			
<b>Origin Airport</b>	<b>Airport Name</b>	<b>FMC-CDU Departure</b>	<b>FMC-CDU Runway</b>
LIBC	Crotone, Italy	CDC5B	RW17
LIPZ	Venezia/Tessera, Italy	CHI5H	RW22
LIPZ	Venezia/Tessera, Italy	RON5H	RW22
LIPZ	Venezia/Tessera, Italy	ROTA5H	RW22
LIRQ	Florence, Italy	PIS5A	RW23
LLBG	Tel Aviv/D. Ben Gurion, Israel	IRM2E	RW26
LLBG	Tel Aviv/D. Ben Gurion, Israel	IRM2F	RW30
LLBG	Tel Aviv/D. Ben Gurion, Israel	NAT3E	RW26
LLBG	Tel Aviv/D. Ben Gurion, Israel	SALA2E	RW26
LLBG	Tel Aviv/D. Ben Gurion, Israel	SALA2F	RW30
LLBG	Tel Aviv/D. Ben Gurion, Israel	SOL3E	RW26
LLBG	Tel Aviv/D. Ben Gurion, Israel	TALM2E	RW26
MGGT	Guatemala/La Aurora, Guatemala	SJOB	RW01
MKJP	Kingston/Norman Manley, Jamaica	ENEKA3	RW30
MKJP	Kingston/Norman Manley, Jamaica	LETUM3	RW30
MKJP	Kingston/Norman Manley, Jamaica	NORAN3	RW30
MKJP	Kingston/Norman Manley, Jamaica	OSTER3	RW30
MKJP	Kingston/Norman Manley, Jamaica	OZARK3	RW30
MKJP	Kingston/Norman Manley, Jamaica	TIGON1	RW30
MUCU	Santiago de Cuba/Antonio Maceo, Cuba	CAOBA2	RW09
MUCU	Santiago de Cuba/Antonio Maceo, Cuba	SANTO3	RW09



**Operations Manual Bulletin Attachment**  
**Consecutive Conditional Altitude Waypoints Map Anomaly**

<b>Table B2</b>			
<b>Swissair Navigation Data Base - Standard Instrument Departures</b>			
<b>Origin Airport</b>	<b>Airport Name</b>	<b>FMC-CDU Departure</b>	<b>FMC-CDU Runway</b>
MUCU	Santiago de Cuba/Antonio Maceo, Cuba	SANTO3	RW27
NSFA	Apia/Faleolo, Samoa	ALFA	RW08
NSFA	Apia/Faleolo, Samoa	BRAVO	RW08
NSFA	Apia/Faleolo, Samoa	SALA	RW08
NSFA	Apia/Faleolo, Samoa	TELE	RW08
NSFA	Apia/Faleolo, Samoa	VASA	RW08
OIBB	Bushehr, Iran	KUGV1A	RW31
OIBB	Bushehr, Iran	KUGV1B	RW13
OIBB	Bushehr, Iran	KUGV1C	RW31
OIBB	Bushehr, Iran	KUGV1D	RW13
OICC	Kermanshah, iran	RULI1D	RW11
OIFM	Esfahan, Iran	LABT1A	RW26
OIFM	Esfahan, Iran	LADA1A	RW26
OIFM	Esfahan, Iran	LADA2C	RW26
OIFM	Esfahan, Iran	LADA2D	RW08
OIFM	Esfahan, Iran	LADL1A	RW26
OIFM	Esfahan, Iran	LADL2C	RW26
OIFM	Esfahan, Iran	LADL2D	RW08
OIFM	Esfahan, Iran	LARB1A	RW26
OIGG	Rasht, Iran	RALG1A	RW27
OIGG	Rasht, Iran	RALG1B	RW09
OIGG	Rasht, Iran	RART1A	RW27
OIGG	Rasht, Iran	RART1B	RW09
OIKB	Bandar Abbass, Iran	MOBO1B	RW21
OIKB	Bandar Abbass, Iran	MOBO2C	RW03
OIKB	Bandar Abbass, Iran	TAVN2A	RW03
OIKB	Bandar Abbass, Iran	TAVN2E	RW03

**Operations Manual Bulletin Attachment**  
**Consecutive Conditional Altitude Waypoints Map Anomaly**

<b>Table B2</b>			
<b>Swissair Navigation Data Base - Standard Instrument Departures</b>			
<b>Origin Airport</b>	<b>Airport Name</b>	<b>FMC-CDU Departure</b>	<b>FMC-CDU Runway</b>
OIKK	Kerman, Iran	ALGU2B	RW34
OIKK	Kerman, Iran	ALGU2D	RW34
OIKK	Kerman, Iran	ALGU2E	RW34
OIKK	Kerman, Iran	ALGU2F	RW16
OIKK	Kerman, Iran	ALGU3A	RW34
OIKK	Kerman, Iran	ALGU3C	RW16
OIKK	Kerman, Iran	ALKE2C	RW34
OIKK	Kerman, Iran	ALKE2D	RW16
OIKK	Kerman, Iran	ALKE3A	RW34
OIKK	Kerman, Iran	ALKE3B	RW16
OIKK	Kerman, Iran	ALKU2D	RW34
OIKK	Kerman, Iran	ALKU2E	RW16
OIKK	Kerman, Iran	ALKU2F	RW16
OIKK	Kerman, Iran	ALKU3A	RW34
OIKK	Kerman, Iran	ALKU3B	RW16
OIKK	Kerman, Iran	ALKU3C	RW16
OIKK	Kerman, Iran	ALME2D	RW34
OIKK	Kerman, Iran	ALME2F	RW16
OIKK	Kerman, Iran	ALME3A	RW34
OIKK	Kerman, Iran	ALME3C	RW16
OIKK	Kerman, Iran	ALMI2A	RW34
OIKK	Kerman, Iran	ALMI2B	RW16
OIKK	Kerman, Iran	ALMI2C	RW16
OIKK	Kerman, Iran	ALMI2D	RW34
OIKK	Kerman, Iran	ALMI2E	RW16
OIKK	Kerman, Iran	ALMI2F	RW16
OIKK	Kerman, Iran	ALMO1A	RW34
OIKK	Kerman, Iran	ALMO2B	RW34

**Operations Manual Bulletin Attachment**  
**Consecutive Conditional Altitude Waypoints Map Anomaly**

<b>Table B2</b>			
<b>Swissair Navigation Data Base - Standard Instrument Departures</b>			
<b>Origin Airport</b>	<b>Airport Name</b>	<b>FMC-CDU Departure</b>	<b>FMC-CDU Runway</b>
OIKK	Kerman, Iran	ALMO2C	RW16
OIKK	Kerman, Iran	ALMO2D	RW34
OIKK	Kerman, Iran	ALMO2E	RW34
OIKK	Kerman, Iran	ALMO2F	RW16
OIMM	Mashhad, Iran	METK2A	RW13
OIMM	Mashhad, Iran	METK2B	RW31
OIMM	Mashhad, Iran	METK2C	RW31
OIMM	Mashhad, Iran	MIDM1A	RW13
OIMM	Mashhad, Iran	MIDM1B	RW31
OIMM	Mashhad, Iran	NOTS2A	RW13
OIMM	Mashhad, Iran	NOTS2B	RW13
OIMM	Mashhad, Iran	NOTS2C	RW31
OIMM	Mashhad, Iran	RAMI2A	RW13
OIMM	Mashhad, Iran	RAMI2B	RW31
OITR	Uromiyeh, Iran	ZAJ1B	RW21
OITT	Tabriz, Iran	RUDA1B	RW12
OITT	Tabriz, Iran	RUDA1D	RW12
OIZH	Zaheadan, Iran	DANO2B	RW17
OIYY	Yazd, Iran	BOMI1D	RW13
OIYY	Yazd, Iran	BONE1D	RW13
OIYY	Yazd, Iran	BONI1D	RW13
OIYY	Yazd, Iran	BONO1D	RW13
OIZH	Zahedan, Iran	DANO2B	RW17
OLBA	Beirut, Lebanon	KAD1C	RW18
OLBA	Beirut, Lebanon	KAD1C	RW21
OLBA	Beirut, Lebanon	KAD1D	RW03
OLBA	Beirut, Lebanon	KAD1D	RW36
ROAH	Naha, Japan	NHC2SR	RW18

**Operations Manual Bulletin Attachment  
Consecutive Conditional Altitude Waypoints Map Anomaly**

<b>Table B2</b>			
<b>Swissair Navigation Data Base - Standard Instrument Departures</b>			
<b>Origin Airport</b>	<b>Airport Name</b>	<b>FMC-CDU Departure</b>	<b>FMC-CDU Runway</b>
RPVB	Bacolod Negros Occidental, Philippines	SID 2	RW22
RPVM	Lapu-Lapu/Mactan, Phillipines	SID15	RW04
RPVM	Lapu-Lapu/Mactan, Phillipines	SID15A	RW04
RPVM	Lapu-Lapu/Mactan, Phillipines	SID16	RW04
SCIE	Concepcion/Carriel, Chile	CO4TCO	RW20
SCIE	Concepcion/Carriel, Chile	CO4VLD	RW20

**Operations Manual Bulletin Attachment**  
**Consecutive Conditional Altitude Waypoints Map Anomaly**

<b>Table B2</b>		
<b>Swissair Navigation Data Base - Approaches/Missed Approaches</b>		
<b>Destination Airport</b>	<b>Airport Name</b>	<b>Approach</b>
EGPB	Sumburgh, UK	ILS27
ENBR	Fergen/Flesland, Norway	ILS35
FCBB	Brazzaville/Maya-Maya, Congo	ILS06
FMCH	Moroni/Hahaia, Comores	ILS02
GCRR	Arrecife/Lanzarote, Canary Is.	ILS04
HAAB	Addis Ababa/Bole, Ethiopia	ILS25
HAAB	Addis Ababa/Bole, Ethiopia	VOR25
HADR	Dire Dawa/Abba Tenna Dejazmatch Yilma, Ethopia	VOR15
HESH	Sharm-El-Shiekh, Egypt	ILS04
KMKC	Kansas City/Downtown, KS	ILS03
KPMD	Palmdale, CA	ILS25
LEAM	Almeria, Spain	NDB08
LEBL	Barcelona, Spain	VOR02
LEBL	Barcelona, Spain	ILS07
LEBL	Barcelona, Spain	ILS25
LFLC	Clermont-Ferrand/Aulnat, France	ILS26
LGKO	Marathon/Kotroni, Greece	VOR15
LGKO	Marathon/Kotroni, Greece	VOR33
LIPE	Bologna/Borgo Panigale, Italy	ILS12
LIRZ	Perugia, Italy	VOR01
LPLA	Lajes-Terceira, Is, Portugal	ILS15
LTCG	Trabzon, Turkey	ILS11
MUCU	Santiago de Cuba/Antonio Maceo, Cuba	ILS09
NWWW	Noumea/La Tontouta, New Caledonia	ILS11
OEDR	Dhahran, Saudi Arabia	ILS34L
OIBJ	Jam Tohid, Iran	VOR11

**Operations Manual Bulletin Attachment**  
**Consecutive Conditional Altitude Waypoints Map Anomaly**

<b>Table B2</b>		
<b>Swissair Navigation Data Base - Approaches/Missed Approaches</b>		
<b>Destination Airport</b>	<b>Airport Name</b>	<b>Approach</b>
OIBJ	Jam Tohid, Iran	ILS11
OINR	Ramsar, Iran	NDB31
PAYA	Yakutat, AK	VOR02
RJCH	Hakodate, Japan	ILS12
RJCH	Hakodate, Japan	LOC12
RJFK	Kagoshima, Japan	ILS34
RJNK	Kanazawa/Komatsu, Japan	ILS06
RJNN	Najoya, Japan	VOR34
RJNN	Najoya, Japan	ILS34
RJSA	Aomori, Japan	ILS24
RJSN	Nigata, Japan	ILS28
RJSS	Sendai, Japan	ILS27
RKPK	Kimhae, Korea	ILS36
RKPK	Kimhae, Korea	LOC36
ROAH	Naha, Japan	VOR18
RPLL	Manila/Ninoy Aquino, Phillipines	VOR06
RPVB	Bacolod Negros Occidental, Phil- lipines	VOR04
VOMM	Madras, India	VOR25
VTUW	Nakon Phanom, Thailand	VOR15
WAPP	Ambon/Patimura, Indonesia	ILS04

**Operations Manual Bulletin Attachment**  
**Consecutive Conditional Altitude Waypoints Map Anomaly**

<b>Table B3</b>			
<b>Racal Navigation Data Base - Standard Instrument Departures</b>			
<b>Origin Airport</b>	<b>Airport Name</b>	<b>FMC-CDU Departure</b>	<b>FMC-CDU Runway</b>
ESNN	Sundsvall-Harnosand, Sweden	LUE1C	RW34
FACT	Cape Town, South Africa	OKTE2B	RW19
FACT	Cape Town, South Africa	PARI2B	RW19
GCFV	Fuerteventura, Canary Is	KORA1R	RW19
GCFV	Fuerteventura, Canary Is	LPC2R	RW19
GCFV	Fuerteventura, Canary Is	LT1R	RW19
GCFV	Fuerteventura, Canary Is	SAMA1R	RW19
GCFV	Fuerteventura, Canary Is	TFN1R	RW19
GCFV	Fuerteventura, Canary Is	TFS2R	RW19
GCFV	Fuerteventura, Canary Is	VAST1R	RW19
LEIB	Ibza, Spain	MHN1E	RW24
LEIB	Ibza, Spain	MJV1E	RW24
LEPA	Palma de Mallorca, Spain	MEBU1A	RW24
LEPA	Palma de Mallorca, Spain	MHN1A	RW24
LEPA	Palma de Mallorca, Spain	MJV1B	RW06
LEPA	Palma de Mallorca, Spain	OSGA1A	RW24
LGMT	Mitilini, Greece	LSV1A	RW33
LIMP	Parma, Italy	PAR5V	RW02
LIMP	Parma, Italy	PAR5Y	RW20
MGGT	Guatemala/La Aurora, Guatemala	PALEN	RW01
MKJP	Kingston/Norman Manley, Jamaica	ENEKA3	RW30
MKJP	Kingston/Norman Manley, Jamaica	MLY1	RW12
MKJP	Kingston/Norman Manley, Jamaica	NORAN3	RW30
MKJP	Kingston/Norman Manley, Jamaica	TIGON1	RW30

**Operations Manual Bulletin Attachment  
Consecutive Conditional Altitude Waypoints Map Anomaly**

<b>Table B3</b>			
<b>Racal Navigation Data Base - Standard Instrument Departures</b>			
<b>Origin Airport</b>	<b>Airport Name</b>	<b>FMC-CDU Departure</b>	<b>FMC-CDU Runway</b>
MUCU	Santiago de Cuba/Antonio Maceo, Cuba	CAOBA2	RW09
MUCU	Santiago de Cuba/Antonio Maceo, Cuba	SANTO3	RW09
MUCU	Santiago de Cuba/Antonio Maceo, Cuba	SANTO3	RW27
OLBA	Beirut, Lebanon	KAD1C	RW18
OLBA	Beirut, Lebanon	KAD1C	RW21



**Operations Manual Bulletin Attachment**  
**Consecutive Conditional Altitude Waypoints Map Anomaly**

<b>Table B3</b>		
<b>Racal Navigation Data Base - Approaches/Missed Approaches</b>		
<b>Destination Airport</b>	<b>Airport Name</b>	<b>Approach</b>
DTTX	Sfax/El Maou, Tunisia	VOR15
DTTX	Sfax/El Maou, Tunisia	VOR33
EGPE	Inverness, UK	VOR06
EGPE	Inverness, UK	VOR24
ENBO	Bodo, Norway	ILS08
GCCR	Arrecife/Lanzarote, Canary Is.	VOR04
HEAX	Alexandria, Egypt	VOR04
HEAX	Alexandria, Egypt	VOR36
KDRO	Durango/La Plata Co., CO	ILS02
LIPE	Bologna/Borgo Panigale, Italy	VOR12
LTCG	Trabzon, Turkey	VOR11
MDPP	Puerto Plata, Dominican Republic	VOR26
MDSO	Santo Domingo/De Las Americas, Dominican Republic	VOR35
NSFA	Faleolo, Samoa	ILS08
NWWW	Noumea/La Tontouta, New Caledonia	ILS11
OEDR	Dhahran, Saudi Arabia	ILS34L
RJCH	Hakodate, Japan	ILS12
RJOM	Matsuyama, Japan	ILS14
RPLL	Manila, Phillipines	ILS06
SLVR	Viru Viru, Bolivia	ILS33
SPIM	Lima-Callao, Peru	VOR33
TFFF	Forte-de-France/Le Lamentin Martinique, France	VOR27
WMKL	Pulau/Langkawi, Malaysia	VOR03

Intentionally  
Blank



# Flight Crew Operations Manual Bulletin for The Boeing Company

The Boeing Company  
Seattle, Washington 98124-2207



**Number:** TBC-7

**IssueDate:** May 17, 2007

**Airplane Effectivity:** All Airplanes

**Subject:** Dual FMC Restarts And Data Link Fail CDU Messages

**Reason:** This bulletin provides information informing flight crews of temporary recommended procedures required to avoid dual FMC restarts.

Information in this bulletin is recommended by The Boeing Company, but may not be FAA approved at the time of writing. In the event of conflict with the FAA approved Airplane Flight Manual (AFM), the AFM shall supersede. The Boeing Company regards the information or procedures described herein as having a direct or indirect bearing on the safe operation of this model airplane.

THE FOLLOWING PROCEDURE AND/OR INFORMATION IS EFFECTIVE UPON RECEIPT

## Background Information

This bulletin applies to airplanes with Product Improvement Package (PIP) software installed in the Flight Management Computer (FMC) and with no ACARS installed. ACARS equipment allows electronic, non-voice communication between the airplane and ground stations. Communications are received in the cockpit on a dedicated ACARS unit, on a printer or, in the case of data link, directly into the Flight Management Computer.

An error in the PIP software results in a restart of both FMC computers when the first waypoint in the route is reached. The dual restart does not occur on every flight, however, it is not predictable. The restart results in both Cuds displaying the menu page with no prompt for selection of the FMC function. Both HSIs will display the MAP FAIL flag during the restart. The FMCs and HSIs normally recover within 30 seconds. After recovery, the FMC prompt will be displayed on the menu page and it can be selected to return to FMC operation. The route will revert to inactive, requiring reactivation and execution. Performance data will be lost during the restart and will have to be re-entered by the crew.

The restart is caused by the PIP software accessing areas of the FMC memory dedicated to ACARS data link. Without the FMC configured for ACARS, the data in this area of memory is misused, resulting in FMC restarts.

As an interim solution to avoid restarts, the FMC will be reconfigured to expect ACARS and data link installed and operational. Because of the reconfiguration, a prompt for a DATA LINK page will be available on the INIT/REF INDEX page. The DATA LINK page will display DATA LINK FAIL in the lower, right corner and will otherwise be a non-functional page. DATA LINK FAIL does not affect the normal operation of the FMC or CDU. Also, a line for Ref OAT and a line for LIM TOGW (limit takeoff gross weight) will appear on the TAKEOFF REF 2/2 page. If a temperature value is entered in the Ref OAT line, the V-speeds on the TAKEOFF REF 1/2 page will revert to dashes. The LIM TOGW line will not display dashes so it will not accept data entered with the CDU numeric keys.

The FMC will be automatically reconfigured with the interim solution in the next navigation data base update.

---

## **Operating Instructions**

Do not use the DATA LINK page. Disregard DATA LINK FAIL indications.

Do not enter a value in the Ref OAT line.

---

## **Administrative Information**

Insert this bulletin behind the Operations Manual Bulletin Record page in Volume 1 of your Operations Manual. Amend the Operations Manual Bulletin Record to show bulletin TBC-7 "In Effect" (IE).

Please send all correspondence regarding Operations Manual Bulletins status to one of the following addresses:

Boeing Commercial Airplanes  
Commercial Aviation Services  
Attn: 757 Manager, Flight Technical Data  
P.O. Box 3707, M/C 20-89  
Seattle, Washington, 98124-2207 USA  
Telephone: (206) 662-4000  
Fax: (206) 662-4743



# Flight Crew Operations Manual Bulletin for The Boeing Company

The Boeing Company  
Seattle, Washington 98124-2207



**Number:** TBC-8

**IssueDate:** May 17, 2007

## **Airplane Effectivity: All Airplanes**

**Subject:** EICAS Indication Of Impending Engine Fuel Filter Bypass

**Reason:** This bulletin informs flight crews of the requirement to check EICAS status messages for indication of impending engine fuel filter bypass.

Information in this bulletin is recommended by The Boeing Company, but may not be FAA approved at the time of writing. In the event of conflict with the FAA approved Airplane Flight Manual (AFM), the AFM shall supersede. The Boeing Company regards the information or procedures described herein as having a direct or indirect bearing on the safe operation of this model airplane.

THE FOLLOWING PROCEDURE AND/OR INFORMATION IS EFFECTIVE UPON RECEIPT

## **Background Information**

Fuel contamination can lead to fuel starvation and engine power loss. Each engine fuel system is equipped with a filter to remove contaminants, and a pressure relief valve to allow bypass of an obstructed filter element. A pressure differential switch provides EICAS indication of filter element obstruction prior to pressure relief valve actuation and filter bypass.

Impending fuel filter bypass is indicated only by the EICAS status message L or R ENG FUEL FILT. A recent finding by the US Federal Aviation Administration (FAA) determined a status level message does not provide appropriate indication of this condition. As a result, a L or R ENG FUEL FILT advisory message will be incorporated into the EICAS computer at a future date. Until the updated EICAS computers are installed, FAA Airworthiness Directive AD 96-07-09 requires flight crews to check EICAS for the status message L or R ENG FUEL FILT. If other status level messages are observed as a consequence of complying with this Airworthiness Directive, the flight crew may deal with them in accordance with the appropriate operator policy.

This bulletin contains instructions for checking status messages and a new Engine Fuel Filter non-normal procedure.

## Operating Instructions

If the EICAS status cue is displayed anytime after engine start, check the status display for the status message L or R ENG FUEL FILT. If a L or R ENG FUEL FILT status message is displayed, refer to the Engine Fuel Filter non-normal procedure in the QRH. Specific crew action in response to single or multiple L or R ENG FUEL FILT messages is not established by Boeing or the FAA. Any crew action is left up to the individual operator policy.

This requirement will remain in effect until updated EICAS computers are installed.

Boeing policy on flight crew use of status messages has not changed. After engine start, any condition having adverse effect on safe continuation of the flight, requiring crew attention, will appear as an EICAS alert message (warning, caution or advisory). Operators are encouraged to upgrade the EICAS computers in existing fleet airplanes as soon as the upgrade is available.

---

## Administrative Information

Insert the attached Temporary Issue QRH page, containing the new ENGINE FUEL FILTER checklist adjacent to the APU and Engines Table of Contents.

Insert this bulletin behind the Operations Manual Bulletin Record page in Volume 1 of your Operations Manual. Amend the Operations Manual Bulletin Record to show bulletin TBC-8 "In Effect" (IE).

This anomaly is corrected by Boeing Service Bulletin 757-31-0059.

Please send all correspondence regarding Operations Manual Bulletins status to one of the following addresses:

Boeing Commercial Airplanes  
Commercial Aviation Services  
Attn: 757 Manager, Flight Technical Data  
P.O. Box 3707, M/C 20-89  
Seattle, Washington, 98124-2207 USA  
Telephone: (206) 662-4000  
Fax: (206) 662-4743



# Flight Crew Operations Manual Bulletin for The Boeing Company

The Boeing Company  
Seattle, Washington 98124-2207



**Number:** TBC-9

**IssueDate:** May 17, 2007

**Airplane Effectivity:** All Airplanes

**Subject:** Engine Parameter Fluctuation

**Reason:** This bulletin provides information informing flight crews of temporary recommended procedures for engine parameter fluctuations during climb.

Information in this bulletin is recommended by The Boeing Company, but may not be FAA approved at the time of writing. In the event of conflict with the FAA approved Airplane Flight Manual (AFM), the AFM shall supersede. The Boeing Company regards the information or procedures described herein as having a direct or indirect bearing on the safe operation of this model airplane.

THE FOLLOWING PROCEDURE AND/OR INFORMATION IS EFFECTIVE UPON RECEIPT

## Background Information

There have been several reports of engine parameter fluctuation (EPR, N1, N2) during climb when engine anti-ice was selected "ON". On some of the events a slight airplane yaw was observed. All of the engine fluctuation events have occurred at climb thrust (approximately 1.25 EPR) and at an altitude of approximately 25,000 feet. The parameter fluctuation (plus or minus 0.05 EPR) and at an altitude of approximately 25,000 feet. The parameter fluctuation (plus or minus 0.05 EPR) is typically initiated by a change of the service bleed conditions. Investigation into these occurrences revealed that in each instance the EEC involved had the current SCN 24C software.

The SCN 24C EEC software revised the control logic for the 14th stage stability bleed valve, and it has been determined that this revised control logic can potentially lead to isolated instances of cycling of both the 2.5 and 14th stage stability bleed valves resulting in engine parameter oscillation.

Boeing and Pratt and Whitney agree that no maintenance action should be performed if engine parameter fluctuations occur during climb with SCN 24C software EEC's provided there are no engine exceedances or EICAS maintenance messages. This is because the anomaly is due to bleed logic resident in the software that triggers the fluctuation on a small number of engines that are sensitive to the condition which the flight crew can easily eliminate with a small thrust lever movement.

Pratt and Whitney and Hamilton Standard have developed software changes to rectify the fluctuation condition, and these changes will be included in the next software revision, which is scheduled to be available in the first quarter 1994.

This bulletin has been coordinated with Pratt and Whitney.

---

## Operating Instructions

In the interim, until the EEC software is changed, a flight crew technique can be used to stabilize the engine if engine parameter fluctuation does occur. The flight crew can either increase or decrease the thrust of the affected engine by moving the thrust lever approximately one-half to one knob width, and the fluctuation should cease in 20 to 30 seconds. After the engine parameters have stabilized, the thrust lever may be adjusted as required.

---

## Administrative Information

Insert this bulletin behind the Operations Manual Bulletin Record page in Volume 1 of your Operations Manual. Amend the Operations Manual Bulletin Record to show bulletin TBC-9 "In Effect" (IE).

Please send all correspondence regarding Operations Manual Bulletins status to one of the following addresses:

Boeing Commercial Airplanes  
Commercial Aviation Services  
Attn: 757 Manager, Flight Technical Data  
P.O. Box 3707, M/C 20-89  
Seattle, Washington, 98124-2207 USA  
Telephone: (206) 662-4000  
Fax: (206) 662-4743





# Flight Crew Operations Manual Bulletin for The Boeing Company

The Boeing Company  
Seattle, Washington 98124-2207



**Number:** TBC-10

**IssueDate:** May 17, 2007

## **Airplane Effectivity: All Airplanes**

**Subject:** Engine Stalls During Ground Operation

**Reason:** This bulletin provides information informing flight crews of temporary recommended procedures for engine stalls on the ground that occur after start.

Information in this bulletin is recommended by The Boeing Company, but may not be FAA approved at the time of writing. In the event of conflict with the FAA approved Airplane Flight Manual (AFM), the AFM shall supersede. The Boeing Company regards the information or procedures described herein as having a direct or indirect bearing on the safe operation of this model airplane.

THE FOLLOWING PROCEDURE AND/OR INFORMATION IS EFFECTIVE UPON RECEIPT

## **Background Information**

Since the fourth quarter of 1991, a small number of engine stalls associated with acceleration from minimum idle during taxi have been reported. Although none of the reported idle stalls have resulted in exceedance of engine limits, the possibility of EGT exceedance exists if the engine continues to operate below idle RPM. The stalls may not be audible. Indications of an idle stall reported by crews were illumination of the Low Oil Pressure light and associated EICAS message, decreasing RPM, and increasing EGT. Several of the stalls have been non-recoverable and resulted in engine shutdown by the flight crew.

Operator maintenance departments have been advised of the idle stall anomaly (reference Boeing all-operator message M-7272-92-3951, "Stability Margin Reduction of PW2000 Series Engines", dated 22 July 1992) and informed the airplane may be released for flight following verification that this anomaly was the cause of the idle stall. Operator flight operations departments have been advised of the importance of proper starting procedures (reference Boeing Flight Operations Technical Bulletin 757-44, "PW2000 Engine Starting", dated July 10, 1992). Proper starting procedures will assist avoiding idle stalls.

Engine stalls that occur during start should be handled with established Aborted Engine Start procedures. The engine may be restarted if engine limits have not been exceeded. A recurring problem during engine start requires maintenance action. An engine problem during taxi (after start is complete) requiring engine shutdown is a non-normal activity, and should be handled with established engine shutdown procedures.

This bulletin has been coordinated with Pratt and Whitney.

---

## Operating Instructions

If an engine should stall during taxi, accomplish an engine shutdown.

A maintenance determination of the reason for the stall should be made prior to flight.

---

## Administrative Information

Insert this bulletin behind the Operations Manual Bulletin Record page in Volume 1 of your Operations Manual. Amend the Operations Manual Bulletin Record to show bulletin TBC-10 "In Effect" (IE).

This Operations Manual Bulletin will be canceled after Boeing is notified that all affected airplanes in the operators fleet have been modified by Pratt and Whitney Service Bulletin PW2000 73-106.

Please send all correspondence regarding Operations Manual Bulletins status to one of the following addresses:

Boeing Commercial Airplanes  
Commercial Aviation Services  
Attn: 757 Manager, Flight Technical Data  
P.O. Box 3707, M/C 20-89  
Seattle, Washington, 98124-2207 USA  
Telephone: (206) 662-4000  
Fax: (206) 662-4743



# Flight Crew Operations Manual Bulletin for The Boeing Company

The Boeing Company  
Seattle, Washington 98124-2207



**Number:** TBC-11

**IssueDate:** May 17, 2007

## **Airplane Effectivity: All Airplanes**

**Subject:** Flight Management Computer (FMC) Anomaly During Descent Phase of Flight

**Reason:** To inform flight crews of a Pegasus-FMC anomaly during the descent phase of flight.

Information in this bulletin is recommended by The Boeing Company, but may not be FAA approved at the time of writing. In the event of conflict with the FAA approved Airplane Flight Manual (AFM), the AFM shall supersede. The Boeing Company regards the information or procedures described herein as having a direct or indirect bearing on the safe operation of this model airplane.

THE FOLLOWING PROCEDURE AND/OR INFORMATION IS EFFECTIVE UPON RECEIPT

## **Background Information**

A Pegasus-FMC anomaly exists which may result in different Flight Mode Annunciation (FMA) pitch mode displays between the Attitude Direction Indicators (ADI) and accompanied by inconsistent flight path deviation indications on the Horizontal Situation Indicators (HSI). This anomaly may occur if any flight plan modification is entered and executed near the top of descent point or during the descent or approach phases of flight. When the anomaly occurs, the FMA pitch mode annunciations "VNAV SPD" and "VNAV PATH" ("VNAV PTH", as installed) simultaneously display between the captain's and first officer's ADIs.

The HSI track deviation scale pointers may also indicate different vertical path deviations and may even result in one or both vertical path deviation scales not being displayed.

Boeing has confirmed this anomaly exists in all Pegasus-FMC software. Pegasus-FMC software is identified by either of the following OP PROGRAM part numbers located on the IDENT page:

- 3413-HNP-02C-03

- 3414-HNP-02C-04.

---

## Operating Instructions

If continued VNAV mode use is desired, perform a "Direct-To" entry to the active waypoint. This action may result in the correct display of consistent FMA pitch modes associated with VNAV operation. If this action does not result in the correct display of consistent FMA pitch modes, and continued flight director and/or autopilot use is desired, select another appropriate Mode Control Panel (MCP) pitch mode.

---

## Administrative Information

Insert this bulletin behind the Operations Manual Bulletin Record page in Volume 1 of your Operations Manual. Amend the Operations Manual Bulletin Record to show bulletin TBC-11 "In Effect" (IE).

This anomaly is corrected by Boeing Service Bulletin 757-34-0186.

Please send all correspondence regarding Operations Manual Bulletins status to one of the following addresses:

Boeing Commercial Airplanes  
Commercial Aviation Services  
Attn: 757 Manager, Flight Technical Data  
P.O. Box 3707, M/C 20-89  
Seattle, Washington, 98124-2207 USA  
Telephone: (206) 662-4000  
Fax: (206) 662-4743



# Flight Crew Operations Manual Bulletin for The Boeing Company

The Boeing Company  
Seattle, Washington 98124-2207



**Number:** TBC-12

**IssueDate:** May 17, 2007

## **Airplane Effectivity: All Airplanes**

**Subject:** Flight Management Computer (FMC) Anomaly of Engine Indicating and Crew Alerting System (EICAS) Alert

**Reason:** To inform flight crews of a Pegasus-FMC alerting anomaly following an FMC failure and associated corrective action.

Information in this bulletin is recommended by The Boeing Company, but may not be FAA approved at the time of writing. In the event of conflict with the FAA approved Airplane Flight Manual (AFM), the AFM shall supersede. The Boeing Company regards the information or procedures described herein as having a direct or indirect bearing on the safe operation of this model airplane.

THE FOLLOWING PROCEDURE AND/OR INFORMATION IS EFFECTIVE UPON RECEIPT

## **Background Information**

A Pegasus-FMC anomaly exists, which may not result in the display of the associated EICAS advisory-level "L FMC FAIL" or "R FMC FAIL" alerts. This anomaly occurs when an FMC experiences specific internal faults that inhibit the transmission of the FMC-failure signal to the EICAS computers. However, the secondary discrete alerting lights and indications associated with an FMC failure will correctly illuminate to provide the necessary flight crew awareness of an FMC failure condition. The secondary discrete alerting lights and indications, which are always associated with an FMC failure, are:

1. Illumination of the amber Control and Display Unit (CDU) "FAIL" light;
2. Display of the amber Horizontal Situation Indicator (HSI) "MAP" flag with the associated FMC Instrument Source Selector positioned to the failed FMC detent; and
3. Display of the "SINGLE FMC [L,R] OPERATION" scratch-pad message on the operable FMC CDU

Boeing has confirmed this anomaly exists in all Pegasus-FMC software. Pegasus-FMC software is identified by either of the following OP PROGRAM part numbers located on the IDENT page:

- 3413-HNP-02C-03
- 3414-HNP-02C-04.

---

## **Operating Instructions**

If the CDU "FAIL" light illuminates accompanied by the display of the "MAP" flag on the associated HSI and the CDU scratch-pad message "SINGLE FMC [L,R] OPERATION", the associated FMC should be considered failed. Therefore, the non-normal FMC FAIL checklist should be accomplished.

---

## **Administrative Information**

Insert this bulletin behind the Operations Manual Bulletin Record page in Volume 1 of your Operations Manual. Amend the Operations Manual Bulletin Record to show bulletin TBC-12 "In Effect" (IE).

This anomaly is corrected by Boeing Service Bulletin 757-34-0186.

Please send all correspondence regarding Operations Manual Bulletins status to one of the following addresses:

Boeing Commercial Airplanes  
Commercial Aviation Services  
Attn: 757 Manager, Flight Technical Data  
P.O. Box 3707, M/C 20-89  
Seattle, Washington, 98124-2207 USA  
Telephone: (206) 662-4000  
Fax: (206) 662-4743



# Flight Crew Operations Manual Bulletin for The Boeing Company

**Number:** TBC-13

**IssueDate:** May 17, 2007

**Airplane Effectivity:** All Airplanes

**Subject:** Flight Management Computer (FMC) Lockup Resulting from Flight Plan Route Uplink

**Reason:** This bulletin describes a Pegasus-FMC Datalink anomaly and associated corrective actions.

Information in this bulletin is recommended by The Boeing Company, but may not be FAA approved at the time of writing. In the event of conflict with the FAA approved Airplane Flight Manual (AFM), the AFM shall supersede. The Boeing Company regards the information or procedures described herein as having a direct or indirect bearing on the safe operation of this model airplane.
---

THE FOLLOWING PROCEDURE AND/OR INFORMATION IS EFFECTIVE UPON RECEIPT

---

## Background Information

A Pegasus-FMC software anomaly exists, which may result in the lock up of both the left and right FMC when repeated attempts to load a route uplink are accomplished. When a route uplink is received and the scratchpad message, "ROUTE 1 UPLINK READY" or "ROUTE 2 UPLINK READY" displays, the flight crew normally loads the route by pushing line-select key 4L adjacent to the "< LOAD" prompt on the RTE 1/X page. If the "< LOAD" prompt is selected and the software anomaly is in effect, the route will not load and the "< LOAD" prompt will continue to display at line-select key 4L. **Furthermore, repeated attempts to load the route uplink may result in a single or dual FMC lockup.** If an FMC lockup occurs, pulling an FMC circuit breaker(s) to remove power will not return either FMC to normal operation.

To resolve the lockup, maintenance personnel, or equivalent, must software load an earlier edition of the navigation database. Line selecting the out-of-date navigation data base on the IDENT page will not correct the lockup.

NOTE: This Pegasus-FMC software anomaly occurs randomly and does not affect all route uplinks.

---

## Operating Instructions

On ground:

When the "ROUTE 1 UPLINK READY" or "ROUTE 2 UPLINK READY" scratchpad message displays, push line-select key 4L adjacent to the "< LOAD" prompt on the RTE 1/X page only once. Verify the "< LOAD" prompt at line-select key 4L on the RTE page disappears.

If the "< LOAD" prompt at line-select key 4L remains displayed, do not re-select. If the route is INACTIVE, select the "PURGE >" prompt at line-select key 4R. The route uplink will purge normally and the FMC will continue normal operation. Subsequent uplinks may be attempted.

If the route is ACTIVE, manually enter a new flight plan, if required. Do not attempt a subsequent load of the failed route uplink. If the aircraft is on the ground, maintenance personnel, or equivalent, may pull both FMC circuit breakers for approximately 10 seconds, then reset both FMC circuit breakers to clear the anomaly.

In flight:

Do not load a route uplink via the "< LOAD" prompt adjacent to line-select key 4L on the RTE 1/X page.

---

## Administrative Information

Insert this bulletin behind the Operations Manual Bulletin Record page in Volume 1 of your Operations Manual. Amend the Operations Manual Bulletin Record to show bulletin TBC-13 "In Effect" (IE).

This anomaly will be corrected by Boeing Service Bulletin 757-34-0181 scheduled to be available April 1, 1999. This Operations Manual Bulletin will be canceled after Boeing is notified that all affected airplanes in the operators fleet have been modified.

Please send all correspondence regarding Operations Manual Bulletins status to one of the following addresses:

Boeing Commercial Airplanes  
Commercial Aviation Services  
Attn: 757 Manager, Flight Technical Data  
P.O. Box 3707, M/C 20-89  
Seattle, Washington, 98124-2207 USA  
Telephone: (206) 662-4000  
Fax: (206) 662-4743





# Flight Crew Operations Manual Bulletin for The Boeing Company

The Boeing Company  
Seattle, Washington 98124-2207



**Number:** TBC-14

**IssueDate:** May 17, 2007

## **Airplane Effectivity: All Airplanes**

**Subject:** Flight Management Computer (FMC) Lockup Resulting from Internal Timer Anomaly

**Reason:** To inform flight crews of a Pegasus-FMC Timer anomaly and associated corrective action.

Information in this bulletin is recommended by The Boeing Company, but may not be FAA approved at the time of writing. In the event of conflict with the FAA approved Airplane Flight Manual (AFM), the AFM shall supersede. The Boeing Company regards the information or procedures described herein as having a direct or indirect bearing on the safe operation of this model airplane.

THE FOLLOWING PROCEDURE AND/OR INFORMATION IS EFFECTIVE UPON RECEIPT

## **Background Information**

A Pegasus-FMC internal software timer anomaly has been discovered, which may result in a single or dual FMC to lockup during power transfers on the ground. This anomaly has been identified to have a timing cycle of approximately 12.5 hours. If a power transfer resulting in an FMC power interrupt occurs during the last 5-minutes of the 12.5-hour timer cycle, a single or dual FMC lockup can occur. This anomaly has not been reported to occur in service while airborne.

757 Maintenance Tip MT34-024, dated July, 15 1998, was issued by The Boeing Company to provide airline maintenance personnel, or equivalent, the necessary information to prevent the FMC software clock timer-induced lockup.

The recommended action specified in this Boeing Maintenance Tip is as follows:

- "To prevent occurrence of an FMC [lockup], cycle the left FMC circuit breaker for at least 10 seconds. Wait for at least 5 minutes after returning power to the left FMC and then cycle the right FMC circuit breaker for at least 10 seconds. Perform this action daily and before any flight operation that will exceed 12.5 hours. If an FMC [lockup] occurs, the FMC can be recovered by performing the aforementioned recommended action."

## Operating Instructions

On the ground before each flight, verify maintenance personnel, or equivalent, have complied with 757 Maintenance Tip MT34-024, dated July 15, 1998:

- If maintenance personnel have complied, then no flight crew action is required.
- If maintenance personnel is not available at your location, the flight crew should perform the recommended action specified in MT34-024, dated July 15, 1998.

---

## Administrative Information

Insert this bulletin behind the Operations Manual Bulletin Record page in Volume 1 of your Operations Manual. Amend the Operations Manual Bulletin Record to show bulletin TBC-14 "In Effect" (IE).

This anomaly will be corrected by Boeing Service Bulletin 757-34-0181 scheduled to be available April 1, 1999. This Operations Manual Bulletin will be canceled after Boeing is notified that all affected airplanes in the operators fleet have been modified.

Please send all correspondence regarding Operations Manual Bulletins status to one of the following addresses:

Boeing Commercial Airplanes  
Commercial Aviation Services  
Attn: 757 Manager, Flight Technical Data  
P.O. Box 3707, M/C 20-89  
Seattle, Washington, 98124-2207 USA  
Telephone: (206) 662-4000  
Fax: (206) 662-4743



# Flight Crew Operations Manual Bulletin for The Boeing Company

The Boeing Company  
Seattle, Washington 98124-2207



**Number:** TBC-15

**IssueDate:** May 17, 2007

**Airplane Effectivity:** All Airplanes

**Subject:** FMC Alternate Airport Anomaly

**Reason:** This bulletin provides information for flight crews regarding FMC anomaly.

Information in this bulletin is recommended by The Boeing Company, but may not be FAA approved at the time of writing. In the event of conflict with the FAA approved Airplane Flight Manual (AFM), the AFM shall supersede. The Boeing Company regards the information or procedures described herein as having a direct or indirect bearing on the safe operation of this model airplane.

THE FOLLOWING PROCEDURE AND/OR INFORMATION IS EFFECTIVE UPON RECEIPT

---

## Background Information

When the ALTN CDU page is selected, the displayed alternate airports may contain only three airports because one airport is duplicated.

This anomaly appears on airplanes with the PEGASUS FMC installed. The PEGASUS FMC can be identified by a VNAV Mode Key on the CDU.

---

## Operating Instructions

If necessary, select or enter the appropriate alternate airport.

---

## Administrative Information

Insert this bulletin behind the Operations Manual Bulletin Record page in Volume 1 of your Operations Manual. Amend the Operations Manual Bulletin Record to show bulletin TBC-15 "In Effect" (IE).

This anomaly will be corrected by Boeing Service Bulletin 757-34-0181 scheduled to be available April 1, 1999. This Operations Manual Bulletin will be canceled after Boeing is notified that all affected airplanes in the operators fleet have been modified.

Please send all correspondence regarding Operations Manual Bulletins status to one of the following addresses:

Boeing Commercial Airplanes  
Commercial Aviation Services  
Attn: 757 Manager, Flight Technical Data  
P.O. Box 3707, M/C 20-89  
Seattle, Washington, 98124-2207 USA  
Telephone: (206) 662-4000  
Fax: (206) 662-4743



# Flight Crew Operations Manual Bulletin for The Boeing Company

The Boeing Company  
Seattle, Washington 98124-2207



**Number:** TBC-16

**IssueDate:** May 17, 2007

**Airplane Effectivity:** All Airplanes

**Subject:** FMC Altitude Display Anomaly

**Reason:** This bulletin provides information for flight crews regarding FMC anomaly.

Information in this bulletin is recommended by The Boeing Company, but may not be FAA approved at the time of writing. In the event of conflict with the FAA approved Airplane Flight Manual (AFM), the AFM shall supersede. The Boeing Company regards the information or procedures described herein as having a direct or indirect bearing on the safe operation of this model airplane.

THE FOLLOWING PROCEDURE AND/OR INFORMATION IS EFFECTIVE UPON RECEIPT

## Background Information

During descent, the HSI and CDU LEGS page may display "altitudes" instead of "flight levels" when above the destination airport's transition level or may display "flight levels" instead of "altitudes" when below the destination airport's transition level. This anomaly should not affect crew checklist procedures which require altimeter change at the transition level for the local area.

This anomaly appears on airplanes with the PEGASUS FMC installed. The PEGASUS FMC can be identified by a VNAV Mode Key on the CDU.

## Operating Instructions

Ensure that the appropriate altimeter setting for the local area is set at transition level.

## Administrative Information

Insert this bulletin behind the Operations Manual Bulletin Record page in Volume 1 of your Operations Manual. Amend the Operations Manual Bulletin Record to show bulletin TBC-16 "In Effect" (IE).

This anomaly will be corrected by Boeing Service Bulletin 757-34-0181 scheduled to be available April 1, 1999. This Operations Manual Bulletin will be canceled after Boeing is notified that all affected airplanes in the operators fleet have been modified.

Please send all correspondence regarding Operations Manual Bulletins status to one of the following addresses:

Boeing Commercial Airplanes  
Commercial Aviation Services  
Attn: 757 Manager, Flight Technical Data  
P.O. Box 3707, M/C 20-89  
Seattle, Washington, 98124-2207 USA  
Telephone: (206) 662-4000  
Fax: (206) 662-4743



# Flight Crew Operations Manual Bulletin for The Boeing Company

The Boeing Company  
Seattle, Washington 98124-2207



**Number:** TBC-17

**IssueDate:** May 17, 2007

**Airplane Effectivity:** All Airplanes

**Subject:** FMC Assumed Temperature Derate Anomaly

**Reason:** This bulletin provides information for flight crews regarding FMC anomaly.

Information in this bulletin is recommended by The Boeing Company, but may not be FAA approved at the time of writing. In the event of conflict with the FAA approved Airplane Flight Manual (AFM), the AFM shall supersede. The Boeing Company regards the information or procedures described herein as having a direct or indirect bearing on the safe operation of this model airplane.

THE FOLLOWING PROCEDURE AND/OR INFORMATION IS EFFECTIVE UPON RECEIPT

---

## Background Information

Re-entering the previously entered assumed temperature on the CDU TAKEOFF REF page may not be accepted by the FMC. Assumed temperature entries selected via the Thrust Mode Select Panel (TMSP) are accepted by the FMC.

This anomaly appears on airplanes with the PEGASUS FMC installed. The PEGASUS FMC can be identified by a VNAV Mode Key on the CDU.

---

## Operating Instructions

Enter assumed temperature using the TMSP if the FMC assumed temperature entry is not accepted.

---

## Administrative Information

Insert this bulletin behind the Operations Manual Bulletin Record page in Volume 1 of your Operations Manual. Amend the Operations Manual Bulletin Record to show bulletin TBC-17 "In Effect" (IE).

This anomaly will be corrected by Boeing Service Bulletin 757-34-0181 scheduled to be available April 1, 1999. This Operations Manual Bulletin will be canceled after Boeing is notified that all affected airplanes in the operators fleet have been modified.

Please send all correspondence regarding Operations Manual Bulletins status to one of the following addresses:

Boeing Commercial Airplanes  
Commercial Aviation Services  
Attn: 757 Manager, Flight Technical Data  
P.O. Box 3707, M/C 20-89  
Seattle, Washington, 98124-2207 USA  
Telephone: (206) 662-4000  
Fax: (206) 662-4743





# Flight Crew Operations Manual Bulletin for The Boeing Company

The Boeing Company  
Seattle, Washington 98124-2207



**Number:** TBC-18

**IssueDate:** May 17, 2007

## **Airplane Effectivity: All Airplanes**

**Subject:** FMC CDU Scratchpad Message "Enter IRS Position"

**Reason:** To inform flight crews the FMC CDU scratchpad message ENTER IRS POSITION may not display when an incorrect present position is entered for IRS alignment.

Information in this bulletin is recommended by The Boeing Company, but may not be FAA approved at the time of writing. In the event of conflict with the FAA approved Airplane Flight Manual (AFM), the AFM shall supersede. The Boeing Company regards the information or procedures described herein as having a direct or indirect bearing on the safe operation of this model airplane.

THE FOLLOWING PROCEDURE AND/OR INFORMATION IS EFFECTIVE UPON RECEIPT

## **Background Information**

The FMC CDU scratchpad message ENTER IRS POSITION indicates the flight crew-entered present position did not pass an IRS comparison check, or the IRS is ready to enter the navigation mode and a present position has not been entered. Operators have reported isolated incidents of IRS alignment without display of the ENTER IRS POSITION message when an incorrect present position has been entered during preflight. As a result, airplanes have inadvertently dispatched with unreliable IRS position information. Engineering analysis indicates the anomaly is the result of a timing problem between the FMCs.

Engaging the autothrottle for takeoff (GPS not available) does not correct the error. If the error is sufficiently large, FMC radio position updating will be locked out in flight. GPS position updating (if available) will function and slowly correct the position error at a rate of 4 NM per minute.

In addition, large initial position errors can cause IRS magnetic variation errors affecting the accuracy of magnetic heading and track. Excessive magnetic track errors can cause AFDS localizer mode failure and subsequent inhibiting of automatic approaches. Complete correction of the FMC/IRS position error requires landing and full realignment in the navigation mode.

The flight crew can detect a large FMC position error by comparing relative positions of the airplane and runway symbols on the HSI. On the POS REF page, individual IRS positions should be compared to the required alignment position (gate coordinates, etc.). If an initial position error is discovered before takeoff, a fast alignment with a correct position entry may not resolve the problem. A full alignment must be accomplished by rotating the IRS Mode Selectors to OFF, then to NAV, and entering the correct present position in the SET IRS POSITION line on the POS INIT page. Also, due to an unrelated anomaly, the use of LAST POS for IRS alignment has not always resulted in correct IRS alignment. If the last positions stored in the FMCs differ, using either for IRS alignment may result in an incorrect alignment position.

This anomaly exists only in PIP FMC and Pegasus FMC. Following are the affected software part numbers:

- Pegasus: 3413-HNP-02C-03.
- PIP: PS4052970-952, -953, -954, -955, -956

---

## **Operating Instructions**

During preflight, after entering present position on SET IRS POS line, select the POS REF page and verify L, C, and R IRS position coordinates are correct.

If an incorrect initial position is discovered in flight, the situation cannot be corrected without full IRS realignment on the ground.

---

## **Administrative Information**

Insert this bulletin behind the Operations Manual Bulletin Record page in Volume 1 of your Operations Manual. Amend the Operations Manual Bulletin Record to show bulletin TBC-18 "In Effect" (IE).

This anomaly is corrected by Boeing Service Bulletin 757-34-0181 or 757-34-0212.

Please send all correspondence regarding Operations Manual Bulletins status to one of the following addresses:

Boeing Commercial Airplanes  
Commercial Aviation Services  
Attn: 757 Manager, Flight Technical Data  
P.O. Box 3707, M/C 20-89  
Seattle, Washington, 98124-2207 USA  
Telephone: (206) 662-4000  
Fax: (206) 662-4743

Intentionally  
Blank



# Flight Crew Operations Manual Bulletin for The Boeing Company

The Boeing Company  
Seattle, Washington 98124-2207



**Number:** TBC-19

**IssueDate:** May 17, 2007

## **Airplane Effectivity: All Airplanes**

**Subject:** FMC Engine Out (E/O) Standard Instrument Departure (SID)

**Reason:** This bulletin provides information for flight crews regarding engine out FMC anomaly after takeoff.

Information in this bulletin is recommended by The Boeing Company, but may not be FAA approved at the time of writing. In the event of conflict with the FAA approved Airplane Flight Manual (AFM), the AFM shall supersede. The Boeing Company regards the information or procedures described herein as having a direct or indirect bearing on the safe operation of this model airplane.

THE FOLLOWING PROCEDURE AND/OR INFORMATION IS EFFECTIVE UPON RECEIPT

## **Background Information**

On flights such as training flights where multiple takeoffs and landings occur, the Engine Out Standard Instrument Departure (E/O SID) will not automatically load with loss of an engine after takeoff. The E/O SID can still be manually selected by the crew.

This anomaly appears on airplanes with the PEGASUS FMC installed. The PEGASUS FMC can be identified by a VNAV Mode Key on the CDU.

## **Operating Instructions**

Ensure the departure runway is re-selected prior to each takeoff if the engines have not been shutdown.

## **Administrative Information**

Insert this bulletin behind the Operations Manual Bulletin Record page in Volume 1 of your Operations Manual. Amend the Operations Manual Bulletin Record to show bulletin TBC-19 "In Effect" (IE).

This anomaly will be corrected by Boeing Service Bulletin 757-34-0181 scheduled to be available April 1, 1999. This Operations Manual Bulletin will be canceled after Boeing is notified that all affected airplanes in the operators fleet have been modified.

Please send all correspondence regarding Operations Manual Bulletins status to one of the following addresses:

Boeing Commercial Airplanes  
Commercial Aviation Services  
Attn: 757 Manager, Flight Technical Data  
P.O. Box 3707, M/C 20-89  
Seattle, Washington, 98124-2207 USA  
Telephone: (206) 662-4000  
Fax: (206) 662-4743



# Flight Crew Operations Manual Bulletin for The Boeing Company

The Boeing Company  
Seattle, Washington 98124-2207



**Number:** TBC-20

**IssueDate:** May 17, 2007

**Airplane Effectivity:** All Airplanes

**Subject:** FMC Failure During VOR Remote Tuning

**Reason:** This bulletin provides information informing flight crews of temporary recommended procedures for VOR remote tuning.

Information in this bulletin is recommended by The Boeing Company, but may not be FAA approved at the time of writing. In the event of conflict with the FAA approved Airplane Flight Manual (AFM), the AFM shall supersede. The Boeing Company regards the information or procedures described herein as having a direct or indirect bearing on the safe operation of this model airplane.

THE FOLLOWING PROCEDURE AND/OR INFORMATION IS EFFECTIVE UPON RECEIPT

## Background Information

While remote tuning a VOR with the FMC during a recent test flight, a dual FMC restart occurred with a loss of performance data and deactivation of the active route. Investigation has revealed that this anomaly is due to a conflict between the FMC tuning master, which is normally the left FMC, and the FMC guidance master, which is determined by which autopilot is engaged. Therefore, this anomaly only occurs when remote tuning a VOR while the right autopilot is engaged, but does not occur every time this situation is encountered.

The indication to the flight crew that this anomaly is about to occur is that when a VOR frequency or identifier is line selected to the VOR display line on Progress page 1/2, the data remains in the scratch pad and does not transfer to the line. If no further action is attempted, an FMC generated short term interrupt will occur, the scratch pad will clear and normal operation will be restored. However, a second attempt to remote tune will result in a long term restart and a loss of performance data and deactivation of the route. A third attempt will result in dual FMC failure (single failure with -952 and -953 software).

## **Operating Instructions**

Until this anomaly is corrected, do not remote tune VOR stations using the FMC when the right autopilot is engaged.

---

## **Administrative Information**

Insert this bulletin behind the Operations Manual Bulletin Record page in Volume 1 of your Operations Manual. Amend the Operations Manual Bulletin Record to show bulletin TBC-20 "In Effect" (IE).

This anomaly is corrected by Boeing Service Bulletin 757-34-0143.

Please send all correspondence regarding Operations Manual Bulletins status to one of the following addresses:

Boeing Commercial Airplanes  
Commercial Aviation Services  
Attn: 757 Manager, Flight Technical Data  
P.O. Box 3707, M/C 20-89  
Seattle, Washington, 98124-2207 USA  
Telephone: (206) 662-4000  
Fax: (206) 662-4743





# Flight Crew Operations Manual Bulletin for The Boeing Company

The Boeing Company  
Seattle, Washington 98124-2207



**Number:** TBC-21

**IssueDate:** May 17, 2007

**Airplane Effectivity:** All Airplanes

**Subject:** FMC Holding Pattern Anomaly

**Reason:** To inform flight crews of incorrect FMC holding pattern size when flying without LNAV engaged.

Information in this bulletin is recommended by The Boeing Company, but may not be FAA approved at the time of writing. In the event of conflict with the FAA approved Airplane Flight Manual (AFM), the AFM shall supersede. The Boeing Company regards the information or procedures described herein as having a direct or indirect bearing on the safe operation of this model airplane.

THE FOLLOWING PROCEDURE AND/OR INFORMATION IS EFFECTIVE UPON RECEIPT

## Background Information

The FMC calculates holding pattern size based on the target holding airspeed, current winds and altitude when crossing the holding fix, and FAA/ICAO holding protected airspace limits. The FMC updates holding pattern size, as required, each time the airplane crosses the holding fix. However, current FMC software prevents pattern size update if LNAV was not engaged on the previous crossing of the holding fix. If a holding pattern has been modified after crossing the holding fix without LNAV engaged, the FMC will not update the holding pattern size when the fix is crossed again. The airplane must cross the holding fix twice with LNAV engaged for FMC holding pattern update to occur. This does not affect holding pattern size for initial holding pattern entry.

The anomaly can occur when descending in holding or modifying a holding pattern. In one reported event, the flight crew created a holding pattern in the FMC at an initial approach fix and entered the holding pattern using HDG SEL. Upon receiving ATC clearance, the flight crew began a descent and engaged LNAV. Before crossing the holding fix twice with LNAV engaged, the flight crew descended to an altitude where the original holding pattern size no longer met protected airspace criteria. A GPWS warning was generated from nearby terrain. This terrain alert would have been avoided had a holding pattern update occurred.

The anomaly does not exist with PEGASUS FMC, P/N S242T102-455.

---

## Operating Instructions

When possible, enter and fly FMC holding patterns with LNAV engaged. Holding pattern size will be updated, as required, each time the airplane crosses the holding fix and the airplane will remain within FAA/ICAO hold protected airspace. Cross check lateral and vertical navigation for proper operation.

If 1) climbing or descending in, or 2) modifying, a holding pattern without LNAV engaged, fly the holding pattern in HDG SEL and use time/distance techniques. Under these conditions, use the FMC holding pattern for reference only since pattern size is not updated when the holding fix is crossed.

---

## Administrative Information

Insert this bulletin behind the Operations Manual Bulletin Record page in Volume 1 of your Operations Manual. Amend the Operations Manual Bulletin Record to show bulletin TBC-21 "In Effect" (IE).

This anomaly is corrected by Boeing Service Bulletin 757-34-0192 or 757-34-0210 or 757-34-0211 or 757-34-0212. Refer to individual Service Bulletin for applicability.

This Operations Manual Bulletin will be canceled after Boeing is notified that all affected airplanes in the operators fleet have been modified.

Please send all correspondence regarding Operations Manual Bulletins status to one of the following addresses:

Boeing Commercial Airplanes  
Commercial Aviation Services  
Attn: 757 Manager, Flight Technical Data  
P.O. Box 3707, M/C 20-89  
Seattle, Washington, 98124-2207 USA  
Telephone: (206) 662-4000  
Fax: (206) 662-4743



# Flight Crew Operations Manual Bulletin for The Boeing Company

The Boeing Company  
Seattle, Washington 98124-2207



**Number:** TBC-22

**IssueDate:** May 17, 2007

**Airplane Effectivity:** All Airplanes

**Subject:** FMC VFR Approach Anomaly

**Reason:** This bulletin provides information informing flight crews of temporary recommended procedures for FMC generated VFR approaches.

Information in this bulletin is recommended by The Boeing Company, but may not be FAA approved at the time of writing. In the event of conflict with the FAA approved Airplane Flight Manual (AFM), the AFM shall supersede. The Boeing Company regards the information or procedures described herein as having a direct or indirect bearing on the safe operation of this model airplane.

THE FOLLOWING PROCEDURE AND/OR INFORMATION IS EFFECTIVE UPON RECEIPT

## Background Information

On a recent customer revenue flight, an anomaly was discovered when a VFR approach was selected. Further evaluation concluded that the anomaly affects airplanes with software version PS4052970-952. The anomaly does not pertain to other FMC software versions.

When operating an FMC with software version PS4052970-952 and an FMC generated VFR approach is selected on the Arrivals page by line selecting the "VFR APPR" prompt, the resulting course from the VFR final approach fix to the runway threshold may be computed in error. The erroneous course is displayed on the legs page and the HSI. The T/D may also be displaced. If engaged, LNAV will fly the displayed erroneous course.

## Operating Instructions

Do not perform FMC generated VFR approaches using the VFR APPR line select key when using this software number. A valid VFR approach with accurate course information can be created by manually inserting the desired runway extension on the RWY EXT line.

When operating FMCs with other software numbers, VFR approaches may still be selected, if available.

---

## Administrative Information

Insert this bulletin behind the Operations Manual Bulletin Record page in Volume 1 of your Operations Manual. Amend the Operations Manual Bulletin Record to show bulletin TBC-22 "In Effect" (IE).

This Operations Manual Bulletin will be canceled after Boeing is notified that the affected FMC operating program is no longer installed on any of the airplanes in the operators fleet.

Please send all correspondence regarding Operations Manual Bulletins status to one of the following addresses:

Boeing Commercial Airplanes  
Commercial Aviation Services  
Attn: 757 Manager, Flight Technical Data  
P.O. Box 3707, M/C 20-89  
Seattle, Washington, 98124-2207 USA  
Telephone: (206) 662-4000  
Fax: (206) 662-4743



# Flight Crew Operations Manual Bulletin for The Boeing Company

The Boeing Company  
Seattle, Washington 98124-2207



**Number:** TBC-23

**IssueDate:** May 17, 2007

## **Airplane Effectivity: All Airplanes**

**Subject:** FMC VNAV Anomaly During Intermediate Level Off

**Reason:** To inform pilots of a VNAV anomaly which may result in a level-off altitude error. Revised to include Service Bulletin information.

Information in this bulletin is recommended by The Boeing Company, but may not be FAA approved at the time of writing. In the event of conflict with the FAA approved Airplane Flight Manual (AFM), the AFM shall supersede. The Boeing Company regards the information or procedures described herein as having a direct or indirect bearing on the safe operation of this model airplane.

THE FOLLOWING PROCEDURE AND/OR INFORMATION IS EFFECTIVE UPON RECEIPT

## **Background Information**

Boeing has received operator reports of VNAV overshooting the intended altitude following climb. This occurred at intermediate altitudes when the local barometric pressure was significantly lower than standard. Each event occurred when the level-off was initiated shortly after climbing through transition altitude.

The FMC uses a filter to smooth the computed aircraft altitude to compensate for a rapid adjustment to the barometric correction setting. This altitude smoothing function compensates for a barometric correction change at the rate of 1 inch mercury (33.9 hPa) or 1000 feet in two minutes. During climb, when a VNAV level-off is initiated shortly after passing transition altitude and the altimeter is reset from a very low pressure to QNE (29.92 or 1013), VNAV may overshoot the level-off. In descent, an undershoot condition may occur when a VNAV level-off is initiated shortly after passing the transition level and the altimeter has been reset from QNE to a very low pressure QNH setting.

The amount of overshoot or undershoot depends on the amount of barometric correction, when the altimeter is reset, and the elapsed time from altimeter reset to level-off.

## Operating Instructions

If leveling off within 2000 feet after changing altimeter setting from QNE to QNH, or QNH to QNE, do not use VNAV to execute the level-off if QNH is less than 29.70 hg/1006 hPa (low altimeter setting). After the level-off is complete, VNAV may be re-engaged for climb or cruise.

---

## Administrative Information

Insert this bulletin behind the Operations Manual Bulletin Record page in Volume 1 of your Operations Manual. Amend the Operations Manual Bulletin Record to show bulletin TBC-23 "In Effect" (IE).

This anomaly is corrected by Boeing Service Bulletin 757-34A0258. This Flight Crew Operations Manual Bulletin will be canceled after Boeing is notified that all affected airplanes in the operator's fleet have been modified.

Please send all correspondence regarding Operations Manual Bulletins status to one of the following addresses:

Boeing Commercial Airplanes  
Commercial Aviation Services  
Attn: 757 Manager, Flight Technical Data  
P.O. Box 3707, M/C 20-89  
Seattle, Washington, 98124-2207 USA  
Telephone: (206) 662-4000  
Fax: (206) 662-4743



# Flight Crew Operations Manual Bulletin for The Boeing Company

The Boeing Company  
Seattle, Washington 98124-2207



**Number:** TBC-24

**IssueDate:** May 17, 2007

## **Airplane Effectivity: All Airplanes**

**Subject:** Heading Reference Switch Operation With -133 Flight Control Computers Installed

**Reason:** This bulletin provides information informing flight crews of temporary recommended procedures for operating the Heading Reference Switch.

Information in this bulletin is recommended by The Boeing Company, but may not be FAA approved at the time of writing. In the event of conflict with the FAA approved Airplane Flight Manual (AFM), the AFM shall supersede. The Boeing Company regards the information or procedures described herein as having a direct or indirect bearing on the safe operation of this model airplane.

THE FOLLOWING PROCEDURE AND/OR INFORMATION IS EFFECTIVE UPON RECEIPT

## **Background Information**

The Heading Reference Switch permits selection of a magnetic or true heading reference for each HSI, the Autopilot Flight Director System (AFDS), and each Flight Management Computer.

If the AFDS is in the HDG SEL mode and the HSI Heading Reference Switch position is changed, the AFDS mode changes to HDG HOLD and the existing heading will be maintained. Due to an anomaly in the -133 FCC, the autopilot may command a turn if the AFDS is in the HDG HOLD mode when the HSI Heading Reference Switch position is changed.

Beginning with Line Number 417, delivered Jan 1992, American Airlines 757 airplanes are equipped with -133 Flight Control Computers. An anomaly in the -133 FCC results in the autopilot turning when the HSI Heading Reference switch is operated with HDG HOLD roll mode engaged. The heading change depends on the amount and direction of the local magnetic variation.

LNAV and HDG SEL modes are not affected by this anomaly.

## **Operating Instructions**

With Heading Hold (HDG HOLD) roll mode engaged, disconnect the autopilot and flight director prior to operating the Heading Reference Switch. Engage the autopilot and/or flight director (if desired) after operating the Heading Reference Switch.

---

## **Administrative Information**

Insert this bulletin behind the Operations Manual Bulletin Record page in Volume 1 of your Operations Manual. Amend the Operations Manual Bulletin Record to show bulletin TBC-24 "In Effect" (IE).

Please send all correspondence regarding Operations Manual Bulletins status to one of the following addresses:

Boeing Commercial Airplanes  
Commercial Aviation Services  
Attn: 757 Manager, Flight Technical Data  
P.O. Box 3707, M/C 20-89  
Seattle, Washington, 98124-2207 USA  
Telephone: (206) 662-4000  
Fax: (206) 662-4743





# Flight Crew Operations Manual Bulletin for The Boeing Company

The Boeing Company  
Seattle, Washington 98124-2207



**Number:** TBC-25

**IssueDate:** May 17, 2007

**Airplane Effectivity:** All Airplanes

**Subject:** Inadvertent Overspeed Protection Trip

**Reason:** This bulletin provides information informing flight crews of temporary information and procedural considerations for engine overspeed protection anomalies.

Information in this bulletin is recommended by The Boeing Company, but may not be FAA approved at the time of writing. In the event of conflict with the FAA approved Airplane Flight Manual (AFM), the AFM shall supersede. The Boeing Company regards the information or procedures described herein as having a direct or indirect bearing on the safe operation of this model airplane.

THE FOLLOWING PROCEDURE AND/OR INFORMATION IS EFFECTIVE UPON RECEIPT

## Background Information

The PW 2037 engine incorporates a mechanical overspeed protective feature that permits the fuel control to override the EEC if N2 RPM exceeds the red line limit by approximately 2%. This feature automatically reduces N2 and schedules fuel flow to maintain a fixed N2 RPM when the overspeed trip occurs.

Evidence of a down shift in the overspeed trip point has been detected on in-service fuel control units. The cause of the downward shift is internal component wear and/or contamination. The evidence indicates a potential for the trip point to shift to the 100% red line N2 speed limit and eventually into the engine operating range. This condition creates the increased probability of an inadvertent overspeed protection system trip when high thrust is initially set, such as for takeoff or go-around.

Pratt and Whitney is working with the fuel control supplier to determine the scope of the problem and to develop follow on corrective action.

In the interim crews should be made aware of the subject condition. If an engine overspeed trip occurs inflight, the N2 reduces to and remains at 87% regardless of thrust lever movement. If engine operation is continued at this fixed RPM, thrust on this engine alone will be significantly higher than total thrust required for an approach, even at maximum landing weight.

The overspeed protection trip is reset when the fuel control switch is moved to cutoff. Crew workload permitting, the engine may be shutdown and an engine inflight start performed to restore normal thrust control. However, thrust in the affected engine should not be increased to the level at which the overspeed trip occurred.

---

## **Administrative Information**

Insert this bulletin behind the Operations Manual Bulletin Record page in Volume 1 of your Operations Manual. Amend the Operations Manual Bulletin Record to show bulletin TBC-25 "In Effect" (IE).

This bulletin will remain in effect until a corrective action program is implemented by Pratt and Whitney.

Please send all correspondence regarding Operations Manual Bulletins status to one of the following addresses:

Boeing Commercial Airplanes  
Commercial Aviation Services  
Attn: 757 Manager, Flight Technical Data  
P.O. Box 3707, M/C 20-89  
Seattle, Washington, 98124-2207 USA  
Telephone: (206) 662-4000  
Fax: (206) 662-4743



# Flight Crew Operations Manual Bulletin for The Boeing Company

The Boeing Company  
Seattle, Washington 98124-2207



**Number:** TBC-26

**IssueDate:** May 17, 2007

## **Airplane Effectivity: All Airplanes**

**Subject:** Incorrect Display of VREF On The ADI Speed Tape

**Reason:** This bulletin provides information for flight crews regarding FMC anomaly.

Information in this bulletin is recommended by The Boeing Company, but may not be FAA approved at the time of writing. In the event of conflict with the FAA approved Airplane Flight Manual (AFM), the AFM shall supersede. The Boeing Company regards the information or procedures described herein as having a direct or indirect bearing on the safe operation of this model airplane.

THE FOLLOWING PROCEDURE AND/OR INFORMATION IS EFFECTIVE UPON RECEIPT

## **Background Information**

Flight test has discovered an anomaly in the Pegasus FMC which may cause the display of incorrect Vref information on one of the two ADI Speed Tapes. When a manual "speed-only" Vref change is made to a previously entered Vref on the APPROACH REF page, the new value will be displayed correctly on one Speed Tape, but the other Speed Tape will remain at the previously entered speed value. This anomaly occurs only when a speed scratchpad entry (/ XXX ) is line-selected into 4R on the APPROACH REF page.

Example 1, no anomaly: During the Approach check, the Captain downselects line 3R (30<sup>o</sup> / 133 KT) and then enters it into 4R. The 133 KT Vref speed bug will be correctly displayed on both sides.

Example 2, with anomaly: The Captain directs a Vref speed change to 140 KT and "/ 140 " is entered into 4R on the APPROACH REF page. In this case, the Vref bug will be displayed at 140 on one speed tape, but the previously entered value (133) is displayed on the other speed tape. The speed tape displaying the correct value is on the side of the master FMC and does not depend on which CDU is used to make the input. This anomaly only occurs when a speed-only format entry is made.

This anomaly appears on airplanes with the PEGASUS FMC installed. The PEGASUS FMC can be identified by the OP PROGRAM part number displayed on the IDENT page:

- 3413-HNP-02C-03

---

## Operating Instructions

When a previous Vref entry requires a speed alteration, ensure that the entry into 4R includes both the desired flap setting and the new Vref speed (e.g. 30° / 134). The FMC computed speeds in 1R, 2R, or 3R may also be downselected and then entered into 4R for display on both speed tapes.

---

## Administrative Information

Insert this bulletin behind the Operations Manual Bulletin Record page in Volume 1 of your Operations Manual. Amend the Operations Manual Bulletin Record to show bulletin TBC-26 "In Effect" (IE).

This anomaly will be corrected by Boeing Service Bulletin 757-34-0181 scheduled to be available April 1, 1999. This Operations Manual Bulletin will be canceled after Boeing is notified that all affected airplanes in the operators fleet have been modified.

Please send all correspondence regarding Operations Manual Bulletins status to one of the following addresses:

Boeing Commercial Airplanes  
Commercial Aviation Services  
Attn: 757 Manager, Flight Technical Data  
P.O. Box 3707, M/C 20-89  
Seattle, Washington, 98124-2207 USA  
Telephone: (206) 662-4000  
Fax: (206) 662-4743



# Flight Crew Operations Manual Bulletin for The Boeing Company

The Boeing Company  
Seattle, Washington 98124-2207



**Number:** TBC-27

**IssueDate:** May 17, 2007

## **Airplane Effectivity: All Airplanes**

**Subject:** Interference Between Oxygen Mask Panel Door and Nosewheel Steering Tiller

**Reason:** This bulletin provides information for flight crews regarding interference between the oxygen mask panel door and the nosewheel steering tiller on airplanes with full face oxygen masks installed.

Information in this bulletin is recommended by The Boeing Company, but may not be FAA approved at the time of writing. In the event of conflict with the FAA approved Airplane Flight Manual (AFM), the AFM shall supersede. The Boeing Company regards the information or procedures described herein as having a direct or indirect bearing on the safe operation of this model airplane.

THE FOLLOWING PROCEDURE AND/OR INFORMATION IS EFFECTIVE UPON RECEIPT

## **Background Information**

The Captain and First Officer oxygen mask panels on the flight deck are located just forward of the nosewheel steering tillers. On airplanes with full face masks, the rearmost panel door may obstruct the nosewheel steering tiller when the oxygen mask is removed from the panel and the panel door is left open.

The nosewheel steering tillers move in unison. Therefore, a pilot may experience difficulty due to interference between the oxygen mask panel door and the tiller on the opposite side of the flight deck from the tiller being used for control.

## **Operating Instructions**

Prior to taxi, verify the oxygen mask panel doors are closed to prevent possible nosewheel steering tiller interference.

Prior to landing after any situation when either pilot may be required to wear an oxygen mask in flight, verify the oxygen mask panel doors are closed to prevent possible nosewheel steering tiller interference.

## **Administrative Information**

Insert this bulletin behind the Operations Manual Bulletin Record page in Volume 1 of your Operations Manual. Amend the Operations Manual Bulletin Record to show bulletin TBC-27 "In Effect" (IE).

This anomaly is corrected by Boeing Service Bulletin 757-35-0019. This Operations Manual Bulletin will be canceled after Boeing is notified that all affected airplanes in the operator's fleet have been modified.

Please send all correspondence regarding Operations Manual Bulletins status to one of the following addresses:

Boeing Commercial Airplanes  
Commercial Aviation Services  
Attn: 757 Manager, Flight Technical Data  
P.O. Box 3707, M/C 20-89  
Seattle, Washington, 98124-2207 USA  
Telephone: (206) 662-4000  
Fax: (206) 662-4743



# Flight Crew Operations Manual Bulletin for The Boeing Company

The Boeing Company  
Seattle, Washington 98124-2207



**Number:** TBC-28

**IssueDate:** May 17, 2007

**Airplane Effectivity:** All Airplanes

**Subject:** Invalid ILS Indication

**Reason:** This bulletin provides information informing flight crews of temporary recommended procedures for false localizer and glide slope indications.

Information in this bulletin is recommended by The Boeing Company, but may not be FAA approved at the time of writing. In the event of conflict with the FAA approved Airplane Flight Manual (AFM), the AFM shall supersede. The Boeing Company regards the information or procedures described herein as having a direct or indirect bearing on the safe operation of this model airplane.

THE FOLLOWING PROCEDURE AND/OR INFORMATION IS EFFECTIVE UPON RECEIPT

## Background Information

It has been determined by ground and flight tests that Electro Magnetic Interference (EMI) generated by certain digital electronic equipment may cause false localizer and glide slope indications on the EFIS. The EMI causes audio noise in all three ILS systems and may cause full left deflection of localizer bar and full up deflection of the glide slope deviation bar on both Captain's and First Officer's EFIS. The EMI also affects the standby attitude ILS display. The false indications may occur when the ILS receiver is tuned to a frequency not in use or when a normal signal goes off the air for any reason. There are no visible indications in the cockpit to warn the flight crew of this ILS signal anomaly.

The EMI, which causes false ILS indications, is introduced into the ILS system by coupling through antenna cables and by radiation picked up by the localizer and glide slope antennas. Some ILS frequencies are more susceptible than others to EMI interference. VOR signals and indications are not known to be affected by the EMI.

## Operating Instructions

Until the affected airplanes are modified, the following operating instructions are recommended:

- Follow normal procedures of tuning and aurally identifying the ILS station.
- Continuously monitor the audio signal through completion of the ILS approach.
- Crosscheck altitude and glide slope indications when crossing over outer and middle markers.
- Unless the runway is in sight, do not continue an ILS approach if the ILS audio signal is lost, or if the altitude at the markers is not per the approach plate.
- Do not use ILS localizer to track outbound (eg departures, ILS outbound to procedure turn, or missed approaches).

---

## Administrative Information

Insert this bulletin behind the Operations Manual Bulletin Record page in Volume 1 of your Operations Manual. Amend the Operations Manual Bulletin Record to show bulletin TBC-28 "In Effect" (IE).

This Operations Manual Bulletin will be canceled after Boeing is notified that all affected airplanes in the operators fleet have been modified by Boeing Service Bulletin 757-34A0042.

Please send all correspondence regarding Operations Manual Bulletins status to one of the following addresses:

Boeing Commercial Airplanes  
Commercial Aviation Services  
Attn: 757 Manager, Flight Technical Data  
P.O. Box 3707, M/C 20-89  
Seattle, Washington, 98124-2207 USA  
Telephone: (206) 662-4000  
Fax: (206) 662-4743





# Flight Crew Operations Manual Bulletin for The Boeing Company

The Boeing Company  
Seattle, Washington 98124-2207



**Number:** TBC-29

**IssueDate:** May 17, 2007

**Airplane Effectivity:** All Airplanes

**Subject:** Loss Of FMC Operation

**Reason:** This bulletin provides information informing flight crews of temporary recommended procedures for manually tuning the VOR/DME's.

Information in this bulletin is recommended by The Boeing Company, but may not be FAA approved at the time of writing. In the event of conflict with the FAA approved Airplane Flight Manual (AFM), the AFM shall supersede. The Boeing Company regards the information or procedures described herein as having a direct or indirect bearing on the safe operation of this model airplane.

THE FOLLOWING PROCEDURE AND/OR INFORMATION IS EFFECTIVE UPON RECEIPT

## Background Information

During a recent Boeing flight test both FMC's shutdown after multiple resync attempts. It has been determined that this anomaly may occur with some FMC's when both VOR/DME control panels are operated in MAN. This condition is more likely to occur with a large number of navigation aids in the data base and when flight plan changes are being made through the CDU.

In the unlikely event this problem should occur, recovery of FMC operation can be accomplished only by returning at least one of the VOR/DME control panels to AUTO, and pulling both FMC-L and FMC-R circuit breakers for a minimum of 15 seconds before resetting.

If it is desired to tune both VOR's manually during departure or enroute, at least one of the VOR's should be tuned remotely through the CDU, so that both AUTO/MANUAL Select Switches on the VOR/DME control panels are not in MAN at the same time.

The above recommendations also apply during approaches whenever practical, except for VOR approaches, where current procedures remain unchanged. For VOR approaches, the pilot flying should remain in MAP mode, if map data is acceptable. One pilot is required to display raw data by selecting VOR mode and manually tuning the VOR frequency. The other pilot should preselect the VOR frequency on his VOR/DME control panel and return to AUTO mode.

---

## **Administrative Information**

Insert this bulletin behind the Operations Manual Bulletin Record page in Volume 1 of your Operations Manual. Amend the Operations Manual Bulletin Record to show bulletin TBC-29 "In Effect" (IE).

This Operations Manual Bulletin will be canceled after Boeing is notified that all affected airplanes in the operators fleet have been modified by Boeing Service Bulletin 757-34-0068.

Please send all correspondence regarding Operations Manual Bulletins status to one of the following addresses:

Boeing Commercial Airplanes  
Commercial Aviation Services  
Attn: 757 Manager, Flight Technical Data  
P.O. Box 3707, M/C 20-89  
Seattle, Washington, 98124-2207 USA  
Telephone: (206) 662-4000  
Fax: (206) 662-4743



# Flight Crew Operations Manual Bulletin for The Boeing Company

The Boeing Company  
Seattle, Washington 98124-2207



**Number:** TBC-30

**IssueDate:** May 17, 2007

## **Airplane Effectivity: All Airplanes**

**Subject:** Pegasus Flight Management Computer (FMC) VNAV Level Off Anomaly

**Reason:** This bulletin provides information for flight crews regarding FMC anomaly.

Information in this bulletin is recommended by The Boeing Company, but may not be FAA approved at the time of writing. In the event of conflict with the FAA approved Airplane Flight Manual (AFM), the AFM shall supersede. The Boeing Company regards the information or procedures described herein as having a direct or indirect bearing on the safe operation of this model airplane.

THE FOLLOWING PROCEDURE AND/OR INFORMATION IS EFFECTIVE UPON RECEIPT

## **Background Information**

Several in-service occurrences of an anomaly at high altitude have been reported on airplanes equipped with the Pegasus FMC. During a normal cruise altitude capture, VNAV SPD transitions to VNAV PATH. If the cruise altitude is near Cruise Thrust Limit Altitude and the airplane climb speed is slightly below target cruise speed when altitude capture is initiated, the airplane may pitch down and descend attempting to accelerate to the target speed. Also, some occurrences have been accompanied by a thrust lever reduction concurrent with the descent.

This anomaly appears on airplanes with the PEGASUS FMC installed. The PEGASUS FMC can be identified by the OP PROGRAM part number displayed on the IDENT page:

3413-HNP-02C-03

or

3414-HNP-02C-04

## Operating Instructions

Normal pilot action is appropriate. The Boeing Fight Crew Training Manual and Operations Manual recommend that for any unsatisfactory automatic system performance that the pilot intervenes. Should this anomaly occur at high altitude, the pilot should ensure proper thrust is set and complete the level-off.

Any operator observing this condition, especially where the condition also results in a thrust lever reduction, is requested to provide flight profile data such as:

- summary of pilot actions (CDU entries, flight mode changes, such as autopilot flight level change to VNAV engagement or use of VNAV during climb)
- VNAV mode displayed (VNAV PATH or VNAV SPD)
- autothrottle mode displayed (EPR/N1, SPD, IDLE etc...)
- TMC mode displayed (CLB, CRZ etc...)
- airplane state (altitude, climb rate, speed, and speed target).

This information will greatly assist in the problem analysis and in developing the corrective action to fix this FMC anomaly. Boeing and Honeywell are investigating. This anomaly will be corrected in a future Pegasus FMC software revision.

---

## Administrative Information

Insert this bulletin behind the Operations Manual Bulletin Record page in Volume 1 of your Operations Manual. Amend the Operations Manual Bulletin Record to show bulletin TBC-30 "In Effect" (IE).

This Operations Manual Bulletin will be canceled after Boeing is notified that all affected airplanes in the operators fleet have been modified by Boeing Service Bulletin 757-34-0186.

Please send all correspondence regarding Operations Manual Bulletins status to one of the following addresses:

Boeing Commercial Airplanes  
Commercial Aviation Services  
Attn: 757 Manager, Flight Technical Data  
P.O. Box 3707, M/C 20-89  
Seattle, Washington, 98124-2207 USA  
Telephone: (206) 662-4000  
Fax: (206) 662-4743



# Flight Crew Operations Manual Bulletin for The Boeing Company

The Boeing Company  
Seattle, Washington 98124-2207



**Number:** TBC-31

**IssueDate:** May 17, 2007

**Airplane Effectivity:** All Airplanes

**Subject:** Pegasus FMC HSI Map Display Anomaly

**Reason:** This bulletin provides information for flight crews regarding an FMC anomaly.

Information in this bulletin is recommended by The Boeing Company, but may not be FAA approved at the time of writing. In the event of conflict with the FAA approved Airplane Flight Manual (AFM), the AFM shall supersede. The Boeing Company regards the information or procedures described herein as having a direct or indirect bearing on the safe operation of this model airplane.

THE FOLLOWING PROCEDURE AND/OR INFORMATION IS EFFECTIVE UPON RECEIPT

## Background Information

Data search function. At initial power up, the FMC searches the navigation database for all nav aids, airports, and waypoints within a 700NM radius and loads them into memory. The data search function requires approximately 25 seconds and is done in background (not visible to the pilot). The search is also initiated when any function on the HSI control panel is changed (e.g. range scale, mode, or map switches). If a "power transition" occurs while the search is in progress, the search function will not operate again until power is removed from the FMC's. Removing FMC power resets the search function.

Problem. Operators have reported several in-service occurrences of an HSI display anomaly in which nav aids, airports, and waypoints were not displayed when the respective switch on the HSI control panel was selected. The anomaly is caused by the occurrence of an airplane power transition (e.g. during engine start) while the FMC's EFIS data search function is in progress.

This anomaly may not be detectable by the crew until the airplane is more than 700NM from the departure airport because it is likely that a successful search occurred at power up prior to any failure. In this case, the map data may appear correct until exceeding the 700NM radius. Beyond that radius, map background data may not be displayed. Tuned nav aids, alternate airports (as shown on the ALTN page) and entries on the FIX page will be displayed as expected.

This anomaly appears on airplanes with the PEGASUS FMC installed. The PEGASUS FMC can be identified by the OP PROGRAM part numbers, either 3413-HNP-02C-03 or 3414-HNP-02C-04, displayed on the IDENT page.

---

## **Operating Instructions**

1. Avoid making switch selections on the HSI control panel within approximately 30 seconds of an anticipated power transfer (e.g. ground to APU, APU to engine generator).
2. If preflight data has already been entered and the anomaly is suspected (e.g. an unanticipated power transfer occurred), normal operation can be restored by maintenance personnel as advised in the Boeing maintenance TIP sheets 757 MT 34-032 and 767 MT 34-036 dated 06 Aug 99.
3. If this occurs while airborne, the discrepancy should be documented for maintenance action.

---

## **Administrative Information**

Insert this bulletin behind the Operations Manual Bulletin Record page in Volume 1 of your Operations Manual. Amend the Operations Manual Bulletin Record to show bulletin TBC-31 "In Effect" (IE).

This Operations Manual Bulletin will be canceled after Boeing is notified that all affected airplanes in the operators fleet have been modified by Boeing Service Bulletin 757-34-0186.

Please send all correspondence regarding Operations Manual Bulletins status to one of the following addresses:

Boeing Commercial Airplanes  
Commercial Aviation Services  
Attn: 757 Manager, Flight Technical Data  
P.O. Box 3707, M/C 20-89  
Seattle, Washington, 98124-2207 USA  
Telephone: (206) 662-4000  
Fax: (206) 662-4743



# Flight Crew Operations Manual Bulletin for The Boeing Company

The Boeing Company  
Seattle, Washington 98124-2207



**Number:** TBC-32

**IssueDate:** May 17, 2007

**Airplane Effectivity:** All Airplanes

**Subject:** Pegasus-FMC Control and Display Unit (CDU) Anomaly

**Reason:** To inform flight crews of a Pegasus-FMC CDU anomaly and associated corrective actions.

Information in this bulletin is recommended by The Boeing Company, but may not be FAA approved at the time of writing. In the event of conflict with the FAA approved Airplane Flight Manual (AFM), the AFM shall supersede. The Boeing Company regards the information or procedures described herein as having a direct or indirect bearing on the safe operation of this model airplane.

THE FOLLOWING PROCEDURE AND/OR INFORMATION IS EFFECTIVE UPON RECEIPT

## Background Information

An anomaly has been discovered, which may cause a CDU keyboard to not respond to any CDU function and mode key selections with the exception of the "MENU" function and mode key. This CDU anomaly may cause a CDU to reset to a non-responsive state following one or multiple power transfers. This could occur during a normal engine start sequence or at any time power transfers from one generator source to another. This anomaly occurs only during CDU resets after power interrupts.

This anomaly appears on airplanes with the PEGASUS FMC installed. The PEGASUS FMC can be identified by a "VNAV" mode key on the CDU.

A CDU software update is scheduled for February 1999, which will correct the anomaly.

## Operating Instructions

There are two flight crew actions, either of which return the CDU to normal operation in the event a CDU does not respond to function and mode key selections. They are:

(1) Push the "MENU" key on the affected CDU keyboard. This action will display the MENU page with the FMC prompt at line-select key 1L. Then, push line-select key 1L.

or

(2) Rotate the Nav Instrument Source Selector on the affected side to the offside FMC detent, then return the selector to the respective FMC position.

---

## **Administrative Information**

Insert this bulletin behind the Operations Manual Bulletin Record page in Volume 1 of your Operations Manual. Amend the Operations Manual Bulletin Record to show bulletin TBC-32 "In Effect" (IE).

This Operations Manual Bulletin will be canceled after Boeing is notified that all affected airplanes in the operators fleet have been modified by Boeing Service Bulletin 757-34-0185.

Please send all correspondence regarding Operations Manual Bulletins status to one of the following addresses:

Boeing Commercial Airplanes  
Commercial Aviation Services  
Attn: 757 Manager, Flight Technical Data  
P.O. Box 3707, M/C 20-89  
Seattle, Washington, 98124-2207 USA  
Telephone: (206) 662-4000  
Fax: (206) 662-4743





# Flight Crew Operations Manual Bulletin for The Boeing Company

The Boeing Company  
Seattle, Washington 98124-2207



**Number:** TBC-33

**IssueDate:** May 17, 2007

**Airplane Effectivity:** All Airplanes

**Subject:** RB211-535C Engine Surge

**Reason:** This bulletin provides information informing flight crews of temporary recommended procedures for preventing high thrust surge/stall.

Information in this bulletin is recommended by The Boeing Company, but may not be FAA approved at the time of writing. In the event of conflict with the FAA approved Airplane Flight Manual (AFM), the AFM shall supersede. The Boeing Company regards the information or procedures described herein as having a direct or indirect bearing on the safe operation of this model airplane.

THE FOLLOWING PROCEDURE AND/OR INFORMATION IS EFFECTIVE UPON RECEIPT

## Background Information

Five high cycle RB211-535C engines have experienced recoverable surge/stalls during takeoff. Tests conducted by the engine manufacturer reveal that the loss of high thrust surge/stall margin is related to a lack of thermal stabilization and a high number of flight cycles.

The high thrust surge/stall margin of an engine, especially one that is not thermally stabilized, decreases as a function of increased thrust. The most adverse surge/stall margin occurs about 40 seconds after takeoff thrust is set. Although the surge/stall margin is improved by reducing the level of takeoff thrust, any subsequent increase in thrust during the takeoff may induce surge/stall.

Rolls Royce has issued two Non-Modification Service Bulletins.

SB 72-8249 requires a full thrust takeoff and a warm-up procedure on high cycle engines identified in that Bulletin.

SB 72-8251 provides an engine health check and a requirement for full thrust takeoffs and/or engine warm-up as identified in that Bulletin.

Either Bulletin requires suitable placards to be installed by the operator on those airplanes requiring full thrust takeoffs and/or engine warm-up procedures to assure flight crew compliance with the operating restrictions contained in the applicable service bulletin. The placard should be located on the front instrument panel in full view of the flight crew.

---

## Operating Instructions

The following interim operating instructions are in effect until further notice.

### ENGINE WARM-UP BEFORE TAKEOFF

#### If Engines Have Been Shutdown For More Than 3 Hours:

Non Placarded Engines:

- Operate the engines at idle or taxi power for at least 5 minutes prior to takeoff.

Engines With Warm-up and Full Thrust Takeoff Placards:

- Operate the placarded engine(s) for at least 3 minutes at idle or taxi power then at 60% N1 for 2 minutes prior to applying takeoff thrust.
- Commence takeoff within 5 minutes after the completion of the 2 minutes 60% N1 warm-up period.

#### If Engines Have Been Shutdown For Less Than 3 Hours:

- Operate engines at idle or taxi power for at least 3 minutes. No additional warm-up is required prior to applying takeoff thrust.

### ENGINES WITH FULL THRUST TAKEOFF PLACARD

Reduced thrust procedures are not permitted when an appropriate placard is installed. When required, takeoffs shall be made at maximum rated thrust with EECs ON, if operable. In the event an EEC is inoperative, the takeoff should be made with both EECs OFF and maximum rated thrust set manually. With maximum rated thrust set, advancing thrust levers farther during takeoff or initial climb, is not required. During maximum rated thrust takeoffs, flight crews should anticipate higher rates of climb.

### ENGINE SURGE

If engine surge should occur during takeoff it is usually audible and accompanied by rapidly rising EGT, and decreasing EPR and RPM. After a safe altitude is attained and even if EGT limits were exceeded, normal engine operation can be recovered by throttling back to idle until the EGT has decreased below 500oC. Thrust may then be restored, as required, up to Max Continuous and, as long as engine parameters remain within limits, normal engine operation may be resumed.

## **Administrative Information**

Insert this bulletin behind the Operations Manual Bulletin Record page in Volume 1 of your Operations Manual. Amend the Operations Manual Bulletin Record to show bulletin TBC-33 "In Effect" (IE).

Please send all correspondence regarding Operations Manual Bulletins status to one of the following addresses:

Boeing Commercial Airplanes  
Commercial Aviation Services  
Attn: 757 Manager, Flight Technical Data  
P.O. Box 3707, M/C 20-89  
Seattle, Washington, 98124-2207 USA  
Telephone: (206) 662-4000  
Fax: (206) 662-4743

Intentionally  
Blank



# Flight Crew Operations Manual Bulletin for The Boeing Company

The Boeing Company  
Seattle, Washington 98124-2207



**Number:** TBC-34

**IssueDate:** May 17, 2007

## **Airplane Effectivity: All Airplanes**

**Subject:** RB211-535E4 Engine Rundown During Descent

**Reason:** This bulletin provides information explaining event history and conditions that can lead to inadvertent engine failure. Engineering changes and crew procedures are specified.

Information in this bulletin is recommended by The Boeing Company, but may not be FAA approved at the time of writing. In the event of conflict with the FAA approved Airplane Flight Manual (AFM), the AFM shall supersede. The Boeing Company regards the information or procedures described herein as having a direct or indirect bearing on the safe operation of this model airplane.

THE FOLLOWING PROCEDURE AND/OR INFORMATION IS EFFECTIVE UPON RECEIPT

## **Background Information**

Boeing and Rolls-Royce have received seven reports of rundown of RB211-535E4 series engines during descent. Each of the events were reported to have occurred during potential icing conditions or adverse weather, and between 25,000 and 30,000 feet altitude. Six of the events occurred during acceleration to approach idle which is automatically commanded upon selection of engine anti-ice. The seventh event occurred during an acceleration from minimum idle which was initiated by the autothrottle. Boeing and Rolls-Royce have reviewed flight data recorder data from each of the rundowns. In four of the events, the data indicated that the other engine, which did not run down, exhibited parameter fluctuations which are consistent with a compressor stall.

Because all of the events occurred in adverse weather, we have concluded that weather caused a deterioration in the engines' handling characteristics. Analysis of all available information suggests that icing of the compressor inlet or ingestion of ice shed from the compressor inlet caused a reduction in engine stall margin. To address this condition, Boeing and Rolls-Royce have considered several modifications to improve the engine compressor stall margin. We have determined that the most appropriate means of accomplishing this improvement is to modify the Fuel Flow Governor (FFG) to increase the engine's minimum idle speed.

---

## Operating Instructions

Flight crews shall turn on engine anti-ice prior to thrust lever retard when beginning a descent. Below 20,000 ft. engine anti-ice may be selected off if atmospheric conditions permit. Follow normal engine anti-icing procedures for the remainder of the descent.

To correct the top of descent point (TOD) for these conditions, flight crews should forecast engine anti-ice on by entering 25,000 on the DESCENT FORECASTS page. Insert this information at least 200 NM prior to the unadjusted top of descent point.

Due to the longer descent, additional trip fuel of approximately 400 lbs/180 kgs will be required.

After engine modification, with Engine Anti-ice off:

As a result of the slight increase in minimum idle thrust, the TOD points on airplanes with one /two modified FFG's will experience an actual TOD point 10/20 NM before the "normal" TOD point currently being computed by the FMC. We feel that this error is small enough to be accepted until the FMC can be updated during a normal update at which time the correct thrust data will be incorporated.

If one or both FFG's are modified, the following is offered as an interim procedure to allow flight crews to more accurately program the TOD point until the FMC is updated. If this procedure is not used, speed brakes may be required to maintain the VNAV path. To program the FMC with the correct top of descent point for the new minimum idle descent, flight crews should forecast engine anti-ice on by entering 10,000 FT if one engine is modified and 20,000 FT if two engines are modified on the DESCENT FORECASTS page. Insert this information at least 200 NM prior to the unadjusted top of descent point.

Due to the slightly longer descent, additional trip fuel of approximately 100 lbs/45 kgs will be required.

If only one engine's FFG is modified, the following effects will be observed/experienced when the thrust levers are at the minimum idle position, with engine anti-ice selected off.

1. There will be a slight split in applicable engine indicators at all altitudes, with the greatest difference being at high altitude. Expect a descent EPR differential of approximately 0.1, and a descent N1 differential of approximately 14%. This thrust differential is greatest at maximum altitudes and will decrease as you descend.
2. Upon acceleration from minimum idle, for example at level off, a slight yaw will be encountered. Under autothrottle control this split thrust condition recovers in from 1 to 2 seconds and requires approximately 1 unit of aileron to control. The event is very gentle and is easily handled by the autopilot and autothrottle.

#### PERFORMANCE IMPACT

Due to the increased minimum idle setting which will be effective both in flight and on the ground, landing ground roll at high altitude airfields has increased slightly. Corrected performance data will be provided by Airplane Flight Manual and Operations Manual revisions. In the interim, operators are advised to determine the allowable landing weight by reducing the Available Landing Field Length, with operational anti-skid, by 80 ft. With anti skid inoperative reduce the Available Landing Field Length by 300 ft. In addition, the Maximum Quick Turn around Weight should be reduced by 1500 lbs/680 kgs. The effect on all other performance, both in flight and on the ground, is considered negligible.

#### ADDENDUM:

Upon compliance with the corrective action specified in the soon to be released Airworthiness Directive the requirement to activate engine anti-ice prior to all descents is removed.

---

### **Administrative Information**

Insert this bulletin behind the Operations Manual Bulletin Record page in Volume 1 of your Operations Manual. Amend the Operations Manual Bulletin Record to show bulletin TBC-34 "In Effect" (IE).

This anomaly is corrected by Rolls-Royce Vendor Bulletin RB211-73-B869.

Please send all correspondence regarding Operations Manual Bulletins status to one of the following addresses:

Boeing Commercial Airplanes  
Commercial Aviation Services  
Attn: 757 Manager, Flight Technical Data  
P.O. Box 3707, M/C 20-89  
Seattle, Washington, 98124-2207 USA  
Telephone: (206) 662-4000  
Fax: (206) 662-4743





# Flight Crew Operations Manual Bulletin for The Boeing Company

The Boeing Company  
Seattle, Washington 98124-2207



**Number:** TBC-35

**IssueDate:** May 17, 2007

**Airplane Effectivity:** All Airplanes

**Subject:** Spoilers - Inflight Deployment

**Reason:** This bulletin provides information informing flight crews of temporary recommended procedures for inadvertent inflight deployment of the spoilers.

Information in this bulletin is recommended by The Boeing Company, but may not be FAA approved at the time of writing. In the event of conflict with the FAA approved Airplane Flight Manual (AFM), the AFM shall supersede. The Boeing Company regards the information or procedures described herein as having a direct or indirect bearing on the safe operation of this model airplane.

THE FOLLOWING PROCEDURE AND/OR INFORMATION IS EFFECTIVE UPON RECEIPT

## Background Information

Service experience has show when extending flaps to 25 or 30, a spoiler may extend. Pilot reports and flight data recorder information indicate spoiler extension is evident by uncommanded airplane roll, and by the requirement to maintain control wheel displacement for a sustained period to counteract the roll. Pilots have also reported spoiler extension is accompanied by the SPOILERS EICAS advisory message and the SPOILERS light on the overhead panel. Spoiler extension may occur with the speedbrakes lever in the DOWN or ARMED detent. Reports and flight recorder data indicate that retracting the flaps to 20 allows the extended spoiler to retract.

Spoiler panels are held in the down position by hydraulic pressure in the spoiler panel hydraulic actuator. Leaking hydraulic actuator seals may cause a pressure drop in the actuator, allowing air loads at flaps 25 and 30 to lift the spoiler panel up. There are no mechanical means to lock spoiler panels in the down position.

Extension of flaps early in the approach will provide added time for recognition and action.

## **Operating Instructions**

If, upon selection of flaps 25 or 30, the SPOILERS EICAS message is observed, uncommanded airplane roll is encountered or sustained control wheel displacement is required, immediately retract flaps to 20 and use flaps 20 and Vref 20 for landing. Select the Ground Proximity Flap Override Switch to OVRD.

---

## **Administrative Information**

Insert this bulletin behind the Operations Manual Bulletin Record page in Volume 1 of your Operations Manual. Amend the Operations Manual Bulletin Record to show bulletin TBC-35 "In Effect" (IE).

This Operations Manual Bulletin will be canceled after Boeing is notified that all affected airplanes in the operators fleet have been modified by Boeing Service Bulletin 757-27A0105.

Please send all correspondence regarding Operations Manual Bulletins status to one of the following addresses:

Boeing Commercial Airplanes  
Commercial Aviation Services  
Attn: 757 Manager, Flight Technical Data  
P.O. Box 3707, M/C 20-89  
Seattle, Washington, 98124-2207 USA  
Telephone: (206) 662-4000  
Fax: (206) 662-4743



# Flight Crew Operations Manual Bulletin for The Boeing Company

The Boeing Company  
Seattle, Washington 98124-2207



**Number:** TBC-36

**IssueDate:** May 17, 2007

## **Airplane Effectivity: All Airplanes**

**Subject:** Uncommanded Autopilot Engagement, Flight Mode Changes, And IAS/MACH Window Speed Changes

**Reason:** To advise flight crews of the possibility of uncommanded autopilot engagement, flight mode changes, and IAS/Mach Window speed changes, and provide recommended temporary instructions for these situations.

Information in this bulletin is recommended by The Boeing Company, but may not be FAA approved at the time of writing. In the event of conflict with the FAA approved Airplane Flight Manual (AFM), the AFM shall supersede. The Boeing Company regards the information or procedures described herein as having a direct or indirect bearing on the safe operation of this model airplane.

THE FOLLOWING PROCEDURE AND/OR INFORMATION IS EFFECTIVE UPON RECEIPT

## **Background Information**

### UNCOMMANDED AUTOPILOT ENGAGEMENT AND FLIGHT MODE CHANGES

Boeing has received reports from operators of uncommanded autopilot engagement and flight mode changes. The reports document at least one rejected takeoff and one undesired heading change. Engineering investigation has determined these anomalies are caused by faulty MCP push-button switches installed during production or subsequent component repair. Intermittent switch malfunction can cause this anomaly without pilot action.

The normal means for disengaging the autopilot, Autopilot Disengage Switches and the Autopilot Disengage Bar, are unaffected by this anomaly and operate normally.

Alert Service Bulletin SB 757-22A0049 corrects these anomalies.

### UNCOMMANDED IAS/MACH WINDOW SELECTED SPEED CHANGES

Boeing has also received reports from operators of unexpected transition from selected speed to 0.80 Mach upon multiple channel autopilot engagement during automatic approach, and upon autopilot disengagement. Under these conditions, the selected IAS/MACH Window speed changes to 0.80 Mach, requiring pilot intervention to regain airspeed control. Investigation has determined these anomalies occur only with older flight control computers (FCC S241T100-101 thru 109 and S241T100-131 thru 133).

Alert Service Bulletin SB 757-22A0049 corrects these anomalies.

---

## Operating Instructions

### UNCOMMANDED AUTOPILOT ENGAGEMENT

Flight crews should closely monitor ADI flight mode annunciations for autopilot status, and be prepared to respond to uncommanded autopilot engagement during critical phases of flight, including takeoff. Uncommanded autopilot engagement can be corrected by disengaging the autopilot.

### UNCOMMANDED FLIGHT MODE CHANGES

Flight crews should closely monitor ADI flight mode annunciations for autothrottle, roll, and pitch status, and be prepared to respond to uncommanded mode changes during critical phases of flight, including takeoff. Uncommanded flight mode changes can be corrected by selecting the desired mode on the MCP.

### UNCOMMANDED IAS/MACH WINDOW SPEED CHANGES

Flight crews should closely monitor command speed bug and be prepared to respond to uncommanded changes to 0.80 Mach under the following conditions:

1. multiple channel autopilot engagement during automatic approach
2. autopilot disengagement

If the command speed changes to 0.80 Mach under either condition; disconnect the autothrottle, push the IAS/MACH Select Switch to change IAS/MACH Window display to IAS, then set desired speed in the IAS/MACH Window. After resetting speed, the autothrottle may be reconnected.

---

## Administrative Information

Insert this bulletin behind the Operations Manual Bulletin Record page in Volume 1 of your Operations Manual. Amend the Operations Manual Bulletin Record to show bulletin TBC-36 "In Effect" (IE).

This Operations Manual Bulletin will be canceled after Boeing is notified that all affected airplanes in the operators fleet have been modified by Boeing Alert Service Bulletin SB 757-22A0049.

Please send all correspondence regarding Operations Manual Bulletins status to one of the following addresses:

Boeing Commercial Airplanes  
Commercial Aviation Services  
Attn: 757 Manager, Flight Technical Data  
P.O. Box 3707, M/C 20-89  
Seattle, Washington, 98124-2207 USA  
Telephone: (206) 662-4000  
Fax: (206) 662-4743

Intentionally  
Blank



# Flight Crew Operations Manual Bulletin for The Boeing Company

The Boeing Company  
Seattle, Washington 98124-2207



**Number:** TBC-37

**IssueDate:** May 17, 2007

## **Airplane Effectivity: All Airplanes**

**Subject:** Uncommanded Autopilot Engagements Or Uncommanded Autoflight Mode Changes

**Reason:** This bulletin provides information contained in Red Bulletin 93-1, dated May 14, 1993, which informed flight crews of temporary recommended procedures in the event of uncommanded autopilot engagement or autoflight mode changes. Revised to correct All-operator Telex number.

Information in this bulletin is recommended by The Boeing Company, but may not be FAA approved at the time of writing. In the event of conflict with the FAA approved Airplane Flight Manual (AFM), the AFM shall supersede. The Boeing Company regards the information or procedures described herein as having a direct or indirect bearing on the safe operation of this model airplane.

THE FOLLOWING PROCEDURE AND/OR INFORMATION IS EFFECTIVE UPON RECEIPT

## **Background Information**

Boeing flight tests have encountered a condition that can cause uncommanded autopilot engagement or mode changes of the autopilot or flight director. This condition may occur at any time or altitude except when multiple autopilots are engaged for approach.

This condition is caused by faulty Mode Control Panel pushbutton switches installed during production or repair. The condition affects the left and center Flight Control Computers. These Flight Control Computers normally provide commands for the left and center autopilots and flight directors.

The normal means for disconnecting the autopilot (autopilot disengage switch, autopilot disengage bar, and control wheel stabilizer trim switches) are not affected by this problem.

## Operating Instructions

Flight crews should be prepared to disengage the autopilot during critical phases of flight including takeoff. Flight Mode Displays must be closely monitored. An uncommanded mode change or autopilot engagement can be corrected by selecting the desired mode or disconnecting the autopilot.

---

## Administrative Information

Insert this bulletin behind the Operations Manual Bulletin Record page in Volume 1 of your Operations Manual. Amend the Operations Manual Bulletin Record to show bulletin TBC-37 "In Effect" (IE).

This Operations Manual Bulletin will be canceled after Boeing is notified that all affected airplanes in the operators fleet have been modified by Collins Component Service Bulletin MCP-701-22-19, dated April 23, 1993 or Collins Component Service Bulletin MCP-704-22-10, dated April 23, 1993. Additional details and specific applicability of the Service Bulletins are contained in Boeing All-operator telex M-7272-93-2738, dated May 10, 1993.

Please send all correspondence regarding Operations Manual Bulletins status to one of the following addresses:

Boeing Commercial Airplanes  
Commercial Aviation Services  
Attn: 757 Manager, Flight Technical Data  
P.O. Box 3707, M/C 20-89  
Seattle, Washington, 98124-2207 USA  
Telephone: (206) 662-4000  
Fax: (206) 662-4743





# Flight Crew Operations Manual Bulletin for The Boeing Company

The Boeing Company  
Seattle, Washington 98124-2207



**Number:** TBC-38

**IssueDate:** May 17, 2007

**Airplane Effectivity:** All Airplanes

**Subject:** Uncommanded CDU Page Changes

**Reason:** This bulletin provides information for flight crews regarding FMC anomaly.

Information in this bulletin is recommended by The Boeing Company, but may not be FAA approved at the time of writing. In the event of conflict with the FAA approved Airplane Flight Manual (AFM), the AFM shall supersede. The Boeing Company regards the information or procedures described herein as having a direct or indirect bearing on the safe operation of this model airplane.

THE FOLLOWING PROCEDURE AND/OR INFORMATION IS EFFECTIVE UPON RECEIPT

---

## Background Information

On airplanes with PEGASUS FMC installed, crews may experience an uncommanded page change on the CDU.

The PEGASUS FMC can be identified by a VNAV Mode Key on the CDU.

---

## Operating Instructions

Select the desired page appropriate for phase of flight.

---

## Administrative Information

Insert this bulletin behind the Operations Manual Bulletin Record page in Volume 1 of your Operations Manual. Amend the Operations Manual Bulletin Record to show bulletin TBC-38 "In Effect" (IE).

This anomaly will be corrected by Boeing Service Bulletin 757-34-0181 scheduled to be available April 1, 1999. This Operations Manual Bulletin will be canceled after Boeing is notified that all affected airplanes in the operators fleet have been modified.

Please send all correspondence regarding Operations Manual Bulletins status to one of the following addresses:

Boeing Commercial Airplanes  
Commercial Aviation Services  
Attn: 757 Manager, Flight Technical Data  
P.O. Box 3707, M/C 20-89  
Seattle, Washington, 98124-2207 USA  
Telephone: (206) 662-4000  
Fax: (206) 662-4743



# Flight Crew Operations Manual Bulletin for The Boeing Company

The Boeing Company  
Seattle, Washington 98124-2207



**Number:** TBC-39

**IssueDate:** May 17, 2007

## **Airplane Effectivity: All Airplanes**

**Subject:** Unscheduled In Motion Brake Application

**Reason:** This bulletin provides information informing flight crews of temporary recommended procedures for arming autobrakes.

Information in this bulletin is recommended by The Boeing Company, but may not be FAA approved at the time of writing. In the event of conflict with the FAA approved Airplane Flight Manual (AFM), the AFM shall supersede. The Boeing Company regards the information or procedures described herein as having a direct or indirect bearing on the safe operation of this model airplane.

THE FOLLOWING PROCEDURE AND/OR INFORMATION IS EFFECTIVE UPON RECEIPT

---

## **Background Information**

Several incidents of unscheduled in motion brake application while positioning the autobrakes selector to RTO have been reported.

---

## **Operating Instructions**

Pending completion of Boeing Service Bulletin 757-32-0065, it is suggested that flight crews comply with the published Boeing procedural sequence and select RTO before taxi. In addition, it is recommended that RTO be selected only when the airplane is not in motion to preclude any possibility of interference with the pushback operation.

---

## **Administrative Information**

Insert this bulletin behind the Operations Manual Bulletin Record page in Volume 1 of your Operations Manual. Amend the Operations Manual Bulletin Record to show bulletin TBC-39 "In Effect" (IE).

This Operations Manual Bulletin will be canceled after Boeing is notified that all affected airplanes in the operators fleet have been modified by Boeing Service Bulletin 757-32-0065.

Please send all correspondence regarding Operations Manual Bulletins status to one of the following addresses:

Boeing Commercial Airplanes  
Commercial Aviation Services  
Attn: 757 Manager, Flight Technical Data  
P.O. Box 3707, M/C 20-89  
Seattle, Washington, 98124-2207 USA  
Telephone: (206) 662-4000  
Fax: (206) 662-4743



# Flight Crew Operations Manual Bulletin for The Boeing Company

The Boeing Company  
Seattle, Washington 98124-2207



**Number:** TBC-40

**IssueDate:** May 17, 2007

**Airplane Effectivity:** All Airplanes

**Subject:** VNAV Descent Through MCP Altitude

**Reason:** This bulletin provides information informing flight crews of temporary recommended procedures for VNAV descents.

Information in this bulletin is recommended by The Boeing Company, but may not be FAA approved at the time of writing. In the event of conflict with the FAA approved Airplane Flight Manual (AFM), the AFM shall supersede. The Boeing Company regards the information or procedures described herein as having a direct or indirect bearing on the safe operation of this model airplane.

THE FOLLOWING PROCEDURE AND/OR INFORMATION IS EFFECTIVE UPON RECEIPT

## Background Information

Operators have reported a condition in which the airplane may descend below the MCP ALTITUDE WINDOW value during VNAV descent.

Boeing has determined this anomaly can occur on all 757 airplanes except for airplanes that both:

- Have "VERSION 2.0" displayed on the FMC CDU IDENT page after the operating program number, and
- Incorporate the VNAV ALT mode.

VNAV descents may continue below the MCP Altitude Window setting when both of the following conditions have been met.

- The HOLD AT line on the RTE LEGS page contains a B (at or below) altitude constraint, and
- The MCP ALTITUDE WINDOW is set for the same value as the B altitude constraint.

The anomaly will not occur when a B altitude constraint is entered on the waypoint line above the HOLD AT waypoint line.

## Operating Instructions

For VNAV descent, flight crews should not use B (at or below) altitude constraints on the HOLD AT line of the RTE LEGS page for holding patterns in the descent profile.

---

## Administrative Information

Insert this bulletin behind the Operations Manual Bulletin Record page in Volume 1 of your Operations Manual. Amend the Operations Manual Bulletin Record to show bulletin TBC-40 "In Effect" (IE).

This Operations Manual Bulletin will be canceled after Boeing is notified that all affected airplanes in the operators fleet have been modified by Boeing Service Bulletin 757-34-0118 or Boeing Service Bulletin 757-34-0119 or Boeing Service Bulletin 757-34-0120 or Boeing Service Bulletin 757-34-0123.

Please send all correspondence regarding Operations Manual Bulletins status to one of the following addresses:

Boeing Commercial Airplanes  
Commercial Aviation Services  
Attn: 757 Manager, Flight Technical Data  
P.O. Box 3707, M/C 20-89  
Seattle, Washington, 98124-2207 USA  
Telephone: (206) 662-4000  
Fax: (206) 662-4743



# Flight Crew Operations Manual Bulletin for The Boeing Company

The Boeing Company  
Seattle, Washington 98124-2207



**Number:** TBC-41

**IssueDate:** May 17, 2007

**Airplane Effectivity:** All Airplanes

**Subject:** VNAV Descent to Holding Altitude

**Reason:** This bulletin provides information for flight crews regarding an FMC anomaly.

Information in this bulletin is recommended by The Boeing Company, but may not be FAA approved at the time of writing. In the event of conflict with the FAA approved Airplane Flight Manual (AFM), the AFM shall supersede. The Boeing Company regards the information or procedures described herein as having a direct or indirect bearing on the safe operation of this model airplane.

THE FOLLOWING PROCEDURE AND/OR INFORMATION IS EFFECTIVE UPON RECEIPT

## Background Information

An operator has reported incidents of VNAV incorrectly allowing descent through the selected MCP altitude. This may occur while descending enroute to a holding pattern. When a VNAV descent is in progress and an altitude constraint is entered in 1R on the HOLD page, the altitude constraint will be displayed in large font on the respective HOLD AT line on the LEGS page. This condition results in the altitude constraint being placed on the HOLD, not necessarily on the waypoint. In some cases, VNAV may allow the airplane to descend below the constraint / HOLD altitude, even if the MCP window is set at the HOLD altitude.

A corresponding anomaly does not exist while the airplane is in a climb. While performing a VNAV climb to a holding pattern, the airplane will not climb through the MCP altitude.

This anomaly has been verified by Boeing and exists in the 200K, 700K, 1-Meg Non PIP FMCs. The anomaly will not occur on those FMCs which incorporate the VNAV ALT mode.

The pilot can identify the applicable FMC by reference to Line 5 on the IDENT page. The applicable FMC will show DRAG FACTOR on Line 5L and F-F Factor (fuel flow factor) on Line 5R.

For information purposes, the non-applicable FMCs will show DRAG/FF (drag and fuel flow factor) on Line 5L and CO DATA on Line 5R (PIP FMC) or OPC on Line 5L and DRAG/FF on Line 5R (PEGASUS). The installed CDU does not provide a reliable indication of the installed FMC because some airplanes have been retrofitted with PIP or PEGASUS FMCs while retaining the basic CDU.

---

## **Operating Instructions**

When directed to descend and hold at a specified altitude at a waypoint in the route, enter the altitude constraint on the LEGS page. This can be done prior to or after creating the HOLD but must be done on the LEGS page.

---

## **Administrative Information**

Insert this bulletin behind the Operations Manual Bulletin Record page in Volume 1 of your Operations Manual. Amend the Operations Manual Bulletin Record to show bulletin TBC-41 "In Effect" (IE).

This anomaly will be corrected by Boeing Service Bulletin 757-34-0192 or 757-34-0210 or 757-34-0211. Refer to individual Service Bulletin for applicability.

Please send all correspondence regarding Operations Manual Bulletins status to one of the following addresses:

Boeing Commercial Airplanes  
Commercial Aviation Services  
Attn: 757 Manager, Flight Technical Data  
P.O. Box 3707, M/C 20-89  
Seattle, Washington, 98124-2207 USA  
Telephone: (206) 662-4000  
Fax: (206) 662-4743





# Flight Crew Operations Manual Bulletin for The Boeing Company

The Boeing Company  
Seattle, Washington 98124-2207



**Number:** TBC-42

**IssueDate:** May 17, 2007

**Airplane Effectivity:** All Airplanes

**Subject:** APU Automatic Shutdown At High Altitude

**Reason:** This bulletin provides flight crews with a modified APU Fault procedure for restarting the APU after an automatic shutdown at high altitude.

Information in this bulletin is recommended by The Boeing Company, but may not be FAA approved at the time of writing. In the event of conflict with the FAA approved Airplane Flight Manual (AFM), the AFM shall supersede. The Boeing Company regards the information or procedures described herein as having a direct or indirect bearing on the safe operation of this model airplane.

THE FOLLOWING PROCEDURE AND/OR INFORMATION IS EFFECTIVE UPON RECEIPT

## Background Information

A recent modification to the APU has been found to cause a possible automatic shutdown of the APU. Automatic shutdown of the APU is indicated by the APU FAULT advisory message on EICAS and illumination of the APU FAULT Light.

Investigations by both Boeing and AlliedSignal have revealed that a new APU Gearbox Shutoff Valve, PN 3616848-1, can cause the automatic shutdown. The PN 3616848-1 valve has been installed on NC074 during production at Boeing and is installed on other airplanes if AlliedSignal Service Bulletin GTCP331-49-7147 has been incorporated.

It has been found that the APU, on airplanes with the PN 3616848-1 valve, can be restarted and will operate normally at or below 35,000 feet.

Older airplanes with a previously installed valve, PN3289514-1, are not experiencing automatic APU shutdowns.

Testing has confirmed that a PN 3616848-2 configuration of the valve corrects the shutdown problem. AlliedSignal Service Bulletin GTCP331-49-7263 provides instructions for replacing the PN 3616848-1 valve with the -2 valve.

## Operating Instructions

If an automatic shutdown of the APU occurs, accomplish the APU Fault procedure.

The APU Fault procedure has been modified to instruct descending to 35,000 feet or below if APU operation is required.

---

## Administrative Information

Insert this bulletin behind the Operations Manual Bulletin Record page in Volume 1 of your Operations Manual. Amend the Operations Manual Bulletin Record to show bulletin TBC-42 "Incorporated" (INC).

This Operations Manual Bulletin will be canceled after Boeing is notified that all affected airplanes in the operators fleet have been modified by AlliedSignal Service Bulletin GTCP331-49-7263.

Please send all correspondence regarding Operations Manual Bulletins status to one of the following addresses:

Boeing Commercial Airplanes  
Commercial Aviation Services  
Attn: 757 Manager, Flight Technical Data  
P.O. Box 3707, M/C 20-89  
Seattle, Washington, 98124-2207 USA  
Telephone: (206) 662-4000  
Fax: (206) 662-4743



# Flight Crew Operations Manual Bulletin for The Boeing Company

The Boeing Company  
Seattle, Washington 98124-2207



**Number:** TBC-43

**IssueDate:** May 17, 2007

**Airplane Effectivity:** All Airplanes

**Subject:** VNAV PATH Altitude Overshoot

**Reason:** To inform crews that during climb the VNAV PATH mode can temporarily overshoot its programmed altitude.

Information in this bulletin is recommended by The Boeing Company, but may not be FAA approved at the time of writing. In the event of conflict with the FAA approved Airplane Flight Manual (AFM), the AFM shall supersede. The Boeing Company regards the information or procedures described herein as having a direct or indirect bearing on the safe operation of this model airplane.

THE FOLLOWING PROCEDURE AND/OR INFORMATION IS EFFECTIVE UPON RECEIPT

## Background Information

Recent testing has shown that during VNAV climbs (using either flight director or autopilot), the VNAV PATH mode may temporarily overshoot the programmed altitude. This can occur during level offs at either waypoint altitude constraints or at the cruise altitude entered on the VNAV cruise page. Altitude overshoots of as much as 500 feet have been observed before the airplane returned to the programmed altitude.

These overshoots are caused by two factors:

1. an unannounced internal FMC performance verification/update of the current VNAV descent path, or
2. a flight crew execution of a FMC modification.

If either of these events happens at or near the altitude where the FMC transitions to VNAV PATH for the level off, mode transition to VNAV PATH is delayed, and the airplane will overshoot the programmed altitude by an amount proportional to the climb rate.

Setting the MCP altitude to each intermediate VNAV waypoint altitude constraint will assure that level offs below the final cruise altitude will occur using the ALT CAP mode, and the overshoot will not occur. However, the final VNAV cruise altitude is always captured in VNAV PATH, and the overshoot will be possible, even if the MCP altitude is set to the final cruise value.

This anomaly only occurs with the following FMCs installed:

- S242T102-226 or S242T102-330 or PS4052970-944

---

## Operating Instructions

Avoid executing any FMC modifications when approaching either a waypoint altitude constraint or the final cruise altitude.

All intermediate waypoint altitude restrictions should be set on the MCP.

During all level offs in the VNAV PATH mode, be prepared to disconnect the autopilot/flight director and manually level the airplane as required.

---

## Administrative Information

Insert this bulletin behind the Operations Manual Bulletin Record page in Volume 1 of your Operations Manual. Amend the Operations Manual Bulletin Record to show bulletin TBC-43 "In Effect" (IE).

This anomaly is corrected by Boeing Service Bulletin 757-34-0153 or Boeing Service Bulletin 757-34-0154 or Boeing Service Bulletin 757-34-0155. Refer to individual Service Bulletin for applicability.

Please send all correspondence regarding Operations Manual Bulletins status to one of the following addresses:

Boeing Commercial Airplanes  
Commercial Aviation Services  
Attn: 757 Manager, Flight Technical Data  
P.O. Box 3707, M/C 20-89  
Seattle, Washington, 98124-2207 USA  
Telephone: (206) 662-4000  
Fax: (206) 662-4743



# Flight Crew Operations Manual Bulletin for The Boeing Company

The Boeing Company  
Seattle, Washington 98124-2207



**Number:** TBC-44

**IssueDate:** May 17, 2007

**Airplane Effectivity:** All Airplanes

**Subject:** Center Tank Fuel Pumps

**Reason:** This bulletin informs flight crews of the potential for fuel pump damage that could create a potential ignition source. This revision provides procedures approved by the FAA per FAA Approval Letter 140S-03-234 as an Alternative Method of Compliance to AD 2002-19-52 and AD 2002-24-51.

Information in this bulletin is recommended by The Boeing Company, but may not be FAA approved at the time of writing. In the event of conflict with the FAA approved Airplane Flight Manual (AFM), the AFM shall supersede. The Boeing Company regards the information or procedures described herein as having a direct or indirect bearing on the safe operation of this model airplane.

THE FOLLOWING PROCEDURE AND/OR INFORMATION IS EFFECTIVE UPON RECEIPT

## Background Information

Inspections of Hydro-Aire fuel pumps found evidence of a chafed stator lead wire bundle that may cause the wire to contact the rotor and produce arcing, thus creating a potential ignition source. Inspections of other damaged Hydro-Aire pumps found evidence of localized overheating of parts in the priming and vapor pump section of the fuel pump, possibly due to extended dry running.

Because of these findings, the FAA issued Airworthiness Directives (AD) 2002-19-52 in September 2002 and AD 2002-24-51 in November 2002 to require flight crews to maintain certain minimum fuel levels in the center fuel tanks when operating any Hydro-Aire fuel pump.

The Operating Instructions of this bulletin provide the procedures as required by the two ADs. In response to numerous requests from operators, however, Boeing has also developed procedures that will minimize dry running of the center tank fuel pumps, while reducing the potential for large quantities of fuel remaining in the center tank. These alternate procedures have been approved by the FAA per Approval Letter 140S-03-234 and are included in the Operating Instructions below.

Boeing is revising the control logic for the center tank fuel pumps to incorporate an automatic shutoff feature to further reduce dry running of the pumps. These updates should be available second quarter 2004 via Boeing service bulletin.

---

## **Operating Instructions**

These procedures have changed slightly from those previously published in accordance with AD 2002-19-52 and AD 2002-24-51. Minor changes have also been made for clarification.

### NORMAL PROCEDURES

The center tank fuel pump switch(es) must be selected OFF at the first indication of fuel pump low pressure any time during the flight. This includes low pressure indications that may occur because of pitch attitude changes.

#### Takeoff and Initial Climb

The center tank fuel pump switches must be ON for takeoff if center tank fuel quantity is 5000 pounds (2300 kilograms) or greater with the airplane readied for initial taxi.

Both center tank fuel pump switches must be OFF for takeoff if center tank fuel is less than 5000 pounds (2300 kilograms) with the airplane readied for initial taxi. Both center tank fuel pumps should be repositioned ON above 10,000 feet or after the pitch attitude has been reduced to begin acceleration to climb speed, if more than 1000 pounds (500 kilograms) remain in the center tank.

#### Climb, Cruise and Descent

Both center tank fuel pump switches must be selected OFF when center tank fuel quantity reaches approximately 1000 pounds (500 kilograms) during climb, cruise, or descent. For airplanes not equipped with a center tank scavenge system, this 1000 pounds (500 kilograms) of center tank fuel may only be used in a low fuel situation.

**Note:** In cruise flight, center tank fuel may be reduced to approximately 800 pounds (400 kilograms) as necessary to extinguish the FUEL CONFIG light and EICAS "FUEL CONFIG" message. This allows the FUEL CONFIG alert to activate for fuel imbalance or low fuel situations.

### NON-NORMAL PROCEDURES

**FUEL CONFIG Indication.** The FUEL CONFIG light will illuminate when there is fuel in the center tank that exceeds 1200 pounds (600 kilograms) and the center tank fuel pump switches are OFF. Do not accomplish the FUEL CONFIGURATION non-normal checklist prior to or during takeoff with less than 5000 pounds (2300 kilograms) of fuel in the center tank, unless there is an imbalance between main tanks or fuel is low in either main tank. After canceling the FUEL CONFIG message, monitor fuel quantity indications and accomplish the appropriate procedure or checklist if a main tank imbalance or main tank low fuel quantity situation occurs.

**Low Fuel.** In a low fuel situation, both center tank pumps may be selected ON and all center tank fuel may be used regardless of the amount of fuel remaining in the tank.

**Pump Failure.** If a center tank fuel pump fails with fuel in the center tank, accomplish the FUEL PUMP non-normal checklist.

**Note:** Both center tank fuel pump switches must be selected OFF when the center tank fuel quantity reaches approximately 1000 pounds (500 kilograms) or at the first indication of fuel pump low pressure.

#### ADDITIONAL INFORMATION

**Fuel Loading.** For the time period that AD 2002-19-52 and AD 2002-24-51 are in effect, the zero fuel gross weight of the airplane plus the weight of center tank fuel may exceed the maximum zero fuel gross weight by up to 5000 pounds (2300 kilograms) for takeoff, climb, cruise, descent and landing, provided that the effects of balance (CG) have been considered.

---

### **Administrative Information**

Insert this bulletin behind the Operations Manual Bulletin Record page in Volume 1 of your Operations Manual. Amend the Operations Manual Bulletin Record to show bulletin TBC-44 "In Effect" (IE).

This bulletin will be cancelled after Boeing has been notified that the center tank fuel pump automatic shutoff feature SB 757-28A0081 is incorporated and the center tank pumps have been inspected via an approved inspection process to ensure proper wire bundle positioning.

Please send all correspondence regarding Operations Manual Bulletins status to one of the following addresses:

Boeing Commercial Airplanes  
Commercial Aviation Services  
Attn: 757 Manager, Flight Technical Data  
P.O. Box 3707, M/C 20-89  
Seattle, Washington, 98124-2207 USA  
Telephone: (206) 662-4000  
Fax: (206) 662-4743





# Flight Crew Operations Manual Bulletin for The Boeing Company

The Boeing Company  
Seattle, Washington 98124-2207



**Number:** TBC-45

**IssueDate:** May 17, 2007

## **Airplane Effectivity: All Airplanes**

**Subject:** FMC Display of ATS Datalink Messages From Previous Flights

**Reason:** To inform flight crews of an FMC anomaly in which old datalink messages are displayed on the CDU.

Information in this bulletin is recommended by The Boeing Company, but may not be FAA approved at the time of writing. In the event of conflict with the FAA approved Airplane Flight Manual (AFM), the AFM shall supersede. The Boeing Company regards the information or procedures described herein as having a direct or indirect bearing on the safe operation of this model airplane.

THE FOLLOWING PROCEDURE AND/OR INFORMATION IS EFFECTIVE UPON RECEIPT

## **Background Information**

An operator has reported occurrences of old Air Traffic Services (ATS) Datalink messages being displayed on the CDU. All reported events involve messages which were transmitted during the airplane's previous flight(s). For example, one crew reported being cleared to FL360 via an uplink "CLIMB TO AND MAINTAIN FL360, REPORT REACHING FL360." The flight crew left the xxxx ATC UPLINK page displayed on the CDU to report arrival at the new altitude. While approaching level-off, the crew noticed that the message text had changed to "CLIMB TO AND MAINTAIN FL350." They contacted ATC via HF and confirmed the original clearance. In another event, a crew noticed during preflight that all of the ATC messages on the previous flight were still displayed on the ATC LOG page.

The ATC log should automatically clear after each flight. This anomaly is allowing the old messages to remain in memory and to be displayed inappropriately.

This anomaly is only anticipated on airplanes that have:

- Pegasus 2002 FMC software or earlier and

- Operational Program Configuration (OPC) option for ATS Datalink is enabled

**Note:** A Boeing Maintenance Tip 757 MT 34-046 will be released recommending opening both FMC circuit breakers sometime prior to each flight and then resetting them after approximately ten seconds.

---

## Operating Instructions

The following should be performed:

1. When each ATC uplink is received during flight, confirm that the uplink message text is similar to that expected and that the timestamp is within a few minutes of that expected. The timestamp is displayed in the respective uplink message page title (e.g. 1428Z ATC UPLINK). Timestamps can also be verified on the ATC LOG page.
2. If the message is left displayed on the CDU or re-displayed after the crew has responded to it, verify that the message and timestamp are unchanged and that the messages and timestamps displayed on the ATC LOG page are valid. If the message text or timestamps are incorrect, or any doubt exists regarding the integrity of the message, revert to voice procedures.

### Example: ATC UPLINK page

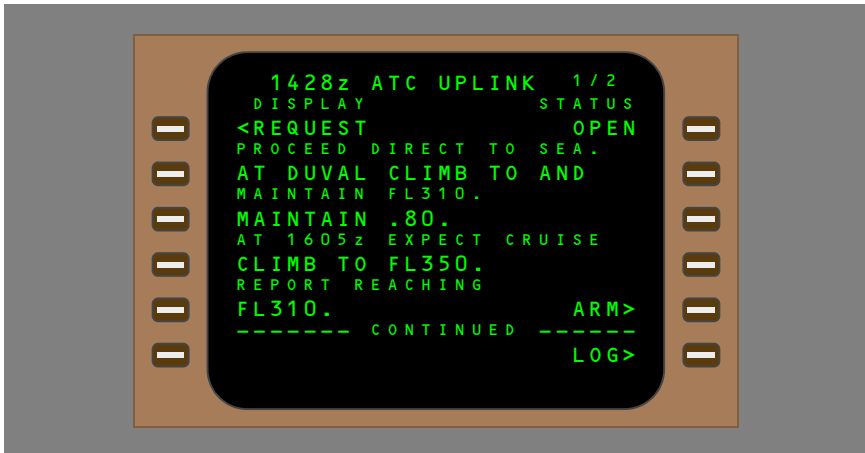

**Example: ATC LOG page**



**Administrative Information**

Insert this bulletin behind the Operations Manual Bulletin Record page in Volume 1 of your Operations Manual. Amend the Operations Manual Bulletin Record to show bulletin TBC-45 "In Effect" (IE).

Pegasus 2003 FMC software will include a change to ensure that all ATS datalink messages from previous flights are erased. Boeing Service Bulletins 757-34-0258 and 757-34-0259 for upgrade to Pegasus 2003 FMC software are scheduled for release in February, 2004.

Please send all correspondence regarding Operations Manual Bulletins status to one of the following addresses:

Boeing Commercial Airplanes  
 Commercial Aviation Services  
 Attn: 757 Manager, Flight Technical Data  
 P.O. Box 3707, M/C 20-89  
 Seattle, Washington, 98124-2207 USA  
 Telephone: (206) 662-4000  
 Fax: (206) 662-4743

Intentionally  
Blank



# Flight Crew Operations Manual Bulletin for The Boeing Company

The Boeing Company  
Seattle, Washington 98124-2207



**Number:** TBC-46

**IssueDate:** May 17, 2007

## **Airplane Effectivity: All Airplanes**

**Subject:** Loss of Inertial Reference System (IRS) Input to RDMI/RMI During Standby Power Operation

**Reason:** To inform affected operators of RDMI/RMI inability to automatically select valid IRS heading data during standby power operation and provide temporary Quick Reference Handbook (QRH) replacement pages.

Information in this bulletin is recommended by The Boeing Company, but may not be FAA approved at the time of writing. In the event of conflict with the FAA approved Airplane Flight Manual (AFM), the AFM shall supersede. The Boeing Company regards the information or procedures described herein as having a direct or indirect bearing on the safe operation of this model airplane.

THE FOLLOWING PROCEDURE AND/OR INFORMATION IS EFFECTIVE UPON RECEIPT

## **Background Information**

Boeing has discovered some airplanes received an incorrect wiring configuration, which affects Radio Distance Magnetic Indicator (RDMI/RMI) operation on standby power. The incorrect wiring exists only on airplanes with production installation of Hydraulic Driven Generator (HDG) wiring provisions. This Operations Manual Bulletin is not effective for airplanes with an HDG installed.

On airplanes without an HDG installed, failure of both engine Integrated Drive Generators (IDG) combined with an Auxiliary Power Unit (APU) or APU electrical generator failure results in the main battery providing the sole source of electrical power. The standby busses are powered from the main battery and are certified to provide a minimum of 30-minutes of power to essential equipment. On some airplane configurations with the main battery and APU battery paralleled, a minimum of 90-minutes of standby electrical power is available.

Normally, the right IRU provides heading data to the captain's RDMI/RMI resulting in proper compass card and VOR-bearing pointer operation. On HDG-equipped airplanes during HDG operation, the right IRU de-powers after a 5-minute time delay with the left and center IRUs continuously remaining powered. In addition, the source input to the captain's RDMI/RMI automatically switches to the center IRU, to sustain normal operation of the RDMI/RMI during HDG operation.

On airplanes with only HDG wiring provisions and without an HDG installed, automatic IRU source switching to the captain's RDMI/RMI is not provided during standby power operation. As a result, the captain's RDMI/RMI compass card "HDG" flag and the left VOR-bearing pointer flag will display due to the loss of valid IRU heading data.

Boeing is in the process of issuing a Service Bulletin to all operators with the incorrect wiring configuration. With the Service Bulletin incorporated on the affected airplanes, the captain's RDMI/RMI will be capable of automatic selection of valid IRS heading data during operation on standby power. As an alternative to retrofitting this Service Bulletin, operators can elect to retrofit an HDG as the existing IRU wiring configuration on the affected airplanes addressed by this Operations Manual Bulletin is compatible with an HDG-equipped airplane.

---

## **Operating Instructions**

Remove and replace the applicable AC BUS OFF checklist in the QRH with the checklist provided by this Operations Manual Bulletin. The revised checklist includes a step to push the first officer's IRS instrument source select switch to the ALTN position. By accomplishing this additional step during execution of the AC BUS OFF checklist, the captain's RDMI/RMI compass card and left VOR bearing pointer will continue to operate normally.

---

## **Administrative Information**

Insert this bulletin behind the Operations Manual Bulletin Record page in Volume 1 of your Operations Manual. Amend the Operations Manual Bulletin Record to show bulletin TBC-46 "Incorporated" (INC).

This anomaly is corrected by Boeing Service Bulletin 757-34-0295. This Operations Manual Bulletin will be canceled after Boeing is notified that all affected airplanes in the operator's fleet have been modified.

Please send all correspondence regarding Operations Manual Bulletins status to one of the following addresses:

Boeing Commercial Airplanes  
Commercial Aviation Services  
Attn: 757 Manager, Flight Technical Data  
P.O. Box 3707, M/C 20-89  
Seattle, Washington, 98124-2207 USA  
Telephone: (206) 662-4000  
Fax: (206) 662-4743

Intentionally  
Blank





# Flight Crew Operations Manual Bulletin for The Boeing Company

The Boeing Company  
Seattle, Washington 98124-2207



**Number:** TBC-47 R1

**IssueDate:** November 18, 2008

**Airplane Effectivity:** All Airplanes

**Subject:** Engine Indication Fluctuations

**Reason:** To inform flight crews of a checklist that addresses the loss of an engine pitot probe.

Revised to remove reference to EPR for accomplishing the “Engine Limit or Surge or Stall” procedure.

Information in this bulletin is recommended by The Boeing Company, but may not be FAA approved at the time of writing. In the event of conflict with the FAA approved Airplane Flight Manual (AFM), the AFM shall supersede. The Boeing Company regards the information or procedures described herein as having a direct or indirect bearing on the safe operation of this model airplane.

THE FOLLOWING PROCEDURE AND/OR INFORMATION IS EFFECTIVE UPON RECEIPT

## Background Information

Rolls-Royce and Boeing have received numerous reports of air turn backs, diversions, and aborted takeoffs due to fluctuating engine parameters. During subsequent inspection, the affected engines are often found to be missing one or more "Pf rake" pitot heads. The Pf rake pitot heads provide input to the EEC. They are installed along the leading edge of the low pressure engine compressor fairings at the upper and lower bifurcation, and on the leading edge of the A-frame support structure.

Missing Pf rake pitot heads result in a fluctuating fan pressure measurement, which causes an unstable EPR calculation. At higher power settings (e.g. greater than approximately 50% N1), the EEC Supervisory control will react to the fluctuating EPR calculation, constantly adjusting the trim to the engine fuel flow to achieve commanded EPR. This causes the fuel flow to fluctuate, which in turn causes all other engine parameters (EPR, N1, EGT, N2) to fluctuate.

## Operating Instructions

If the airplane has a Limiter Control only (no EEC Control switches), the missing Pf rake pitot heads will only cause fluctuating EPR (i.e. remaining engine parameters such as N1, EGT, N2, and fuel flow will not fluctuate) and this bulletin does not apply.

The new checklist includes instructions to select the EEC switches off. If engine parameters (N1, EGT, N2, and fuel flow) continue to fluctuate at high power with the affected EEC off, refer to the existing QRH procedure for "Engine Limit or Surge or Stall". If all engine parameters except EPR stabilize after selecting the affected EEC switch off, the new procedure will select the remaining EEC switch off and continue normal operations with the autothrottle turned off.

The autothrottle requires a reliable EPR indication from both engines to operate properly.

---

## Administrative Information

Insert this bulletin behind the Operations Manual Bulletin Record page in Volume 1 of your Operations Manual. Amend the Operations Manual Bulletin Record to show bulletin TBC-47 R1 "Incorporated" (INC).

This Operations Manual Bulletin will be canceled after Boeing is notified that all affected airplanes in the operator's fleet have been modified by Rolls Royce Service Bulletin RB.211-72-D718 or RB.211-72-E294.

Please send all correspondence regarding Operations Manual Bulletins status to one of the following addresses:

Boeing Commercial Airplanes  
Commercial Aviation Services  
Attn: 757 Manager, Flight Technical Data  
P.O. Box 3707, M/C 20-89  
Seattle, Washington, 98124-2207 USA  
Telephone: (206) 662-4000  
Fax: (206) 662-4743



# Flight Crew Operations Manual Bulletin for The Boeing Company

The Boeing Company  
Seattle, Washington 98124-2207



**Number:** TBC-48

**IssueDate:** May 17, 2007

## **Airplane Effectivity: All Airplanes**

**Subject:** Pegasus Flight Management Computer (FMC) Lock-Up Anomaly Due to Data-Bus Communications Failure

**Reason:** To inform flight crews of a Pegasus-FMC anomaly resulting in the lock up of one or both FMCs and to provide temporary operating instructions for lock-up resolution.

Information in this bulletin is recommended by The Boeing Company, but may not be FAA approved at the time of writing. In the event of conflict with the FAA approved Airplane Flight Manual (AFM), the AFM shall supersede. The Boeing Company regards the information or procedures described herein as having a direct or indirect bearing on the safe operation of this model airplane.

THE FOLLOWING PROCEDURE AND/OR INFORMATION IS EFFECTIVE UPON RECEIPT

## **Background Information**

Boeing has confirmed operator reports of in-service single and dual Pegasus-FMC lock-up events resulting from a data-bus communications anomaly. When the anomaly occurs, one or both FMCs may lock up preventing normal CDU access and control of the FMC(s). This lock-up anomaly and the information and recommended operating instructions contained in this Operations Manual Bulletin are only applicable to Pegasus-FMC software versions.

Operator reports indicate the most common lock-up event involves a single FMC; however, dual FMC lock-up events have also been reported. An FMC lock up is indicated by the continuous display of the "SINGLE FMC OPERATION" scratch-pad message with no response to CDU function or line-select keys and may be accompanied by display of the "L,R FMC FAIL" advisory-level EICAS alert message(s), illumination of the amber FAIL light on the CDU(s), and the amber "MAP" flag on the associated HSI display(s). In some cases, both FMCs may continue to operate normally, but no data communication or data comparison occurs between the master FMC and the spare FMC.

Honeywell is aware of this Pegasus-FMC anomaly. The planned fix to the problem is under investigation.

---

## Operating Instructions

If the "SINGLE FMC OPERATION" scratch-pad message displays on the ground on either CDU, or both FMCs lock up as described above on the ground or in-flight, a single attempt at cycling both FMC circuit breakers can be accomplished, flight conditions permitting, as follows:

**Note:** If in-flight, Boeing recommends the following procedure be accomplished with an autopilot and the autothrottle engaged due to the requirement of a flight crew member leaving his/her station to achieve access to the overhead circuit breaker panel.

Do not use LNAV or VNAV while attempting the following procedure.

L "FMCS CMPTR" circuit breaker (Location E9) - - - - - .PULL

R "FMCS CMPTR" circuit breaker (Location E30) - - - - - PULL

Wait 20 seconds.

L "FMCS CMPTR" circuit breaker (Location E9) - - - - - PUSH

R "FMCS CMPTR" circuit breaker (Location E30) - - - - - PUSH

Wait until MENU page reappears with the "< FMC" prompt at line-select key 1L., then select the prompt by pushing line-select key 1L.

FMC ROUTE - - - - -ENTER

Begin route entry by re-entering ORIGIN airport identifier to ensure previous route is initially deleted.

FMC PERFORMANCE DATA - - - - -ENTER

If normal FMC operation is restored, LNAV and/or VNAV may be engaged, as needed.

The temporary procedural steps provided above should restore normal FMC operation; however, some FMC faults may preclude normal operation. If the above procedure does not restore normal FMC operation, DO NOT accomplish a second attempt as this may result in further systems' degradation.

If the "SINGLE FMC OPERATION" scratch-pad message displays during flight, accomplish the FMC FAIL checklist as published in the Boeing Quick Reference Handbook (QRH), or operator equivalent.

Accomplishing the checklist steps contained in the FMC FAIL checklist will configure the airplane systems for single FMC operation. For Pegasus-FMC equipped airplanes which interface with CDUs equipped with the "MENU" mode-select key, continued ETOPS operation should not be compromised due to the alternate navigation functionality.

## **Administrative Information**

Insert this bulletin behind the Operations Manual Bulletin Record page in Volume 1 of your Operations Manual. Amend the Operations Manual Bulletin Record to show bulletin TBC-48 "In Effect" (IE).

This Operations Manual Bulletin will be revised to include service bulletin information when available. This Operations Manual Bulletin will be canceled after Boeing is notified that all affected airplanes Operations Manual in the operator's fleet have been modified.

Boeing Maintenance Tip 757 MT 34-044 is related to this Operations Manual Bulletin.

Please send all correspondence regarding Operations Manual Bulletins status to one of the following addresses:

Boeing Commercial Airplanes  
Commercial Aviation Services  
Attn: 757 Manager, Flight Technical Data  
P.O. Box 3707, M/C 20-89  
Seattle, Washington, 98124-2207 USA  
Telephone: (206) 662-4000  
Fax: (206) 662-4743

Intentionally  
Blank



# Flight Crew Operations Manual Bulletin for The Boeing Company

The Boeing Company  
Seattle, Washington 98124-2207



**Number:** TBC-49

**IssueDate:** May 17, 2007

## **Airplane Effectivity: All Airplanes**

**Subject:** Incorrect Turn Direction During a Standard Instrument Departure (SID)

**Reason:** To inform pilots of a Pegasus Flight Management Computer System anomaly. Revised to provide additional Service Bulletin information.

Information in this bulletin is recommended by The Boeing Company, but may not be FAA approved at the time of writing. In the event of conflict with the FAA approved Airplane Flight Manual (AFM), the AFM shall supersede. The Boeing Company regards the information or procedures described herein as having a direct or indirect bearing on the safe operation of this model airplane.

THE FOLLOWING PROCEDURE AND/OR INFORMATION IS EFFECTIVE UPON RECEIPT

## **Background Information**

An operator has reported cases of the Pegasus-FMC commanding a turn opposite to that expected and displayed on the map during a SID. Each of the reported occurrences involves a SID with a course reversal shortly after takeoff. In these cases, a right turn was correctly displayed on the map but the FMC commanded a left turn when certain criteria existed. Specifically, when the airplane has a steep initial climb, the airplane may reach an altitude constraint with the airplane in a position to immediately sequence the next leg.

For example, many SIDs are coded with an initial "runway heading" leg (VA leg type) that climbs to a specified altitude. In some procedures, the SID also has a "heading to an intercept" leg (VI leg type) with an associated turn direction following the VA leg. When this anomaly occurs, the airplane may reach the specified altitude in a position to immediately sequence the next (VI) leg.

Should this simultaneous sequence occur, the VI leg with the turn direction is no longer in the route. Since the turn direction is no longer in the route, the FMC will revert to normal turn logic and command a turn in the shortest direction to the new course. The shortest turn direction may be in the opposite direction from that depicted for the departure. When this anomaly occurs, the map will continue to display the correct magenta path but the airplane may turn in the opposite direction

The only reported occurrence of this anomaly has been on the RW34 departures at Fukuoka, Japan. However, the software anomaly could cause a similar problem at other airports.

The information and operating instructions contained in this Flight Crew Operations Manual Bulletin are only applicable to Pegasus-FMC software versions.

---

## **Operating Instructions**

During a SID, should the FD or autopilot begin a turn opposite to that displayed on the map or described in the SID description, use HDG SEL to fly the correct chart course to complete the turn in the correct direction. Following completion of the turn, LNAV may be re-engaged and FD guidance may be followed or the autopilot may be engaged normally.

---

## **Administrative Information**

Insert this bulletin behind the Operations Manual Bulletin Record page in Volume 1 of your Operations Manual. Amend the Operations Manual Bulletin Record to show bulletin TBC-49 "In Effect" (IE).

This anomaly is corrected by Boeing Service Bulletin 757-34-0324 or 757-34-0325. This Flight Crew Operations Manual Bulletin will be canceled after Boeing is notified that all affected airplanes in the operator's fleet have been modified.

Please send all correspondence regarding Operations Manual Bulletins status to one of the following addresses:

Boeing Commercial Airplanes  
Commercial Aviation Services  
Attn: 757 Manager, Flight Technical Data  
P.O. Box 3707, M/C 20-89  
Seattle, Washington, 98124-2207 USA  
Telephone: (206) 662-4000  
Fax: (206) 662-4743





# Flight Crew Operations Manual Bulletin for The Boeing Company

The Boeing Company  
Seattle, Washington 98124-2207



**Number:** TBC-50

**IssueDate:** May 17, 2007

## **Airplane Effectivity: All Airplanes**

**Subject:** Performance Predictions Anomaly in Flight Management Computer (FMC) Product Improvement Package (PIP) and Pegasus Software Versions

**Reason:** To inform flight crews of a performance prediction anomaly on FMC-PIP and Pegasus-FMC software versions.

Information in this bulletin is recommended by The Boeing Company, but may not be FAA approved at the time of writing. In the event of conflict with the FAA approved Airplane Flight Manual (AFM), the AFM shall supersede. The Boeing Company regards the information or procedures described herein as having a direct or indirect bearing on the safe operation of this model airplane.

THE FOLLOWING PROCEDURE AND/OR INFORMATION IS EFFECTIVE UPON RECEIPT

## **Background Information**

Boeing has confirmed operator reports regarding erroneous performance predictions following execution of the ABEAM PTS function on the LEGS page of the FMC-Product Improvement Package (PIP) and Pegasus-FMC software versions. When OAT values have been previously entered in the ALT/OAT field of line-select key 5R on a waypoint WIND page, and the ABEAM PTS function is subsequently selected after a "direct-to" flight plan modification, the OAT value on the WIND page erroneously changes to 0-degrees. After execution, fuel predictions are erroneously recalculated based upon 0-degrees instead of the previously entered value for the respective cruise altitude. Operators have reported display of the INSUFFICIENT FUEL alert-level scratch pad message with the fuel prediction values being much lower than originally planned. Additionally, there are no flight deck annunciations or alerts to indicate an OAT value on the WIND page has erroneously changed.

This Flight Crew Operations Manual Bulletin is only applicable to the FMC-Product Improvement Package (PIP) and Pegasus-FMC software versions. Previous FMC software versions do not include the ABEAM PTS function, the ALT/OAT field entry, or individual waypoint WIND pages, and therefore, are not affected.

---

## **Operating Instructions**

Following selection and prior to executing the ABEAM PTS function, verify the OAT value on the respective WIND page. If necessary, enter the airplane altitude and the indicated Static Air Temperature (SAT) value from PROGRESS page 2 into the ALT/OAT field for the next route waypoint. This OAT entry will propagate to all down-track waypoints. Following entry of the SAT value into the ALT/OAT field and execution of the route modification, the FMC fuel predictions should be near those obtained from the flight plan.

---

## **Administrative Information**

Insert this bulletin behind the Operations Manual Bulletin Record page in Volume 1 of your Operations Manual. Amend the Operations Manual Bulletin Record to show bulletin TBC-50 "In Effect" (IE).

The corrective action for the anomaly described in this Flight Crew Operations Manual Bulletin is still under investigation. This bulletin will be revised to include Service Bulletin information when available.

Please send all correspondence regarding Operations Manual Bulletins status to one of the following addresses:

Boeing Commercial Airplanes  
Commercial Aviation Services  
Attn: 757 Manager, Flight Technical Data  
P.O. Box 3707, M/C 20-89  
Seattle, Washington, 98124-2207 USA  
Telephone: (206) 662-4000  
Fax: (206) 662-4743



# Flight Crew Operations Manual Bulletin for The Boeing Company

The Boeing Company  
Seattle, Washington 98124-2207



**Number:** TBC-51

**IssueDate:** May 17, 2007

## **Airplane Effectivity: All Airplanes**

**Subject:** Pegasus Flight Management Computer (FMC) Departure Routing Anomaly

**Reason:** To inform flight crews of a Pegasus-FMC anomaly regarding route discontinuity removal between a selected departure and the active route.

Information in this bulletin is recommended by The Boeing Company, but may not be FAA approved at the time of writing. In the event of conflict with the FAA approved Airplane Flight Manual (AFM), the AFM shall supersede. The Boeing Company regards the information or procedures described herein as having a direct or indirect bearing on the safe operation of this model airplane.

THE FOLLOWING PROCEDURE AND/OR INFORMATION IS EFFECTIVE UPON RECEIPT

---

## **Background Information**

Boeing has confirmed operator reports of a Pegasus-FMC anomaly related to removal of a route discontinuity between a selected departure and the active route. Boeing engineering has confirmed this software anomaly may occur if a route discontinuity is removed using the RTE page 2 instead of using the RTE LEGS page. Some operator reports indicate the waypoint identifier disappears from the scratch pad when line-selected into the discontinuity boxes, but the RTE page title never indicates the route modification, hence the entry attempt is not successful. And in some cases, a subsequent FMC lockup may result.

Honeywell is aware of this Pegasus-FMC anomaly. The planned fix to the problem is under investigation.

---

## **Operating Instructions**

To prevent the occurrence of this anomaly, removal of route discontinuities between a selected departure and the active route using the RTE LEGS page instead of RTE page 2 is recommended.

## **Administrative Information**

Insert this bulletin behind the Operations Manual Bulletin Record page in Volume 1 of your Operations Manual. Amend the Operations Manual Bulletin Record to show bulletin TBC-51 "In Effect" (IE).

This Flight Crew Operations Manual Bulletin will be revised to include service bulletin information when available.

Please send all correspondence regarding Operations Manual Bulletins status to one of the following addresses:

Boeing Commercial Airplanes  
Commercial Aviation Services  
Attn: 757 Manager, Flight Technical Data  
P.O. Box 3707, M/C 20-89  
Seattle, Washington, 98124-2207 USA  
Telephone: (206) 662-4000  
Fax: (206) 662-4743



# Flight Crew Operations Manual Bulletin for The Boeing Company

The Boeing Company  
Seattle, Washington 98124-2207



**Number:** TBC-52

**IssueDate:** May 17, 2007

## **Airplane Effectivity: All Airplanes**

**Subject:** Uncommanded Auxiliary Power Unit (APU) Shutdown Prior to Engine Start

**Reason:** To inform flight crews of an uncommanded APU shutdown fault prior to engine start and provide temporary operating instructions.

Information in this bulletin is recommended by The Boeing Company, but may not be FAA approved at the time of writing. In the event of conflict with the FAA approved Airplane Flight Manual (AFM), the AFM shall supersede. The Boeing Company regards the information or procedures described herein as having a direct or indirect bearing on the safe operation of this model airplane.

THE FOLLOWING PROCEDURE AND/OR INFORMATION IS EFFECTIVE UPON RECEIPT

## **Background Information**

Boeing has received operator reports of a fault pertaining to an uncommanded Auxiliary Power Unit (APU) shutdown on the ground prior to engine start. Boeing has confirmed the shutdown fault occurs randomly and is a result of pneumatic air reverse flow when either or both Pack Control Selectors are positioned OFF. The uncommanded APU shutdown occurs when the APU Electronic Control Unit (ECU) is unable to compensate for the pneumatic pressure pulse when either or both pack control valve(s) close. Boeing has confirmed the shutdown fault may occur under the following conditions:

- Both engines shutdown;
- APU running;
- APU Bleed Air switch ON; and,
- A Pack Control selector positioned OFF.

Therefore, flight crew recognition of this fault is primarily noticeable when accomplishing the normal "Before Engine Start" procedure after positioning the Pack Control Selectors OFF in preparation for the initial engine start. If the fault is active and an uncommanded APU shutdown occurs, the APU can be restarted without delay without any required time consideration for cool down.

Boeing has confirmed the fault can only occur upon positioning either or both Pack Control Selectors OFF with the APU as the sole source of pneumatic power. Therefore, exposure to the fault described above is isolated to ground operations and specific to APU bleed air supply for initial engine start.

---

## **Operating Instructions**

For operators experiencing in-service interruption due to uncommanded APU shutdown prior to engine start, the following temporary operating instructions are recommended:

Prior to positioning the Pack Control Selectors OFF when accomplishing the "Before Start Procedure", select the APU Bleed Air switch OFF and allow the APU Bleed Air VALVE transition light to momentarily illuminate and extinguish. Then, position the left and right Pack Control Selectors OFF and allow the PACK OFF lights to illuminate. Finally, select the APU Bleed Air switch ON to restore pneumatic air to each engine's starter, and accomplish a normal engine start.

---

## **Administrative Information**

Insert this bulletin behind the Operations Manual Bulletin Record page in Volume 1 of your Operations Manual. Amend the Operations Manual Bulletin Record to show bulletin TBC-52 "In Effect" (IE).

This Flight Crew Operations Manual Bulletin will be revised to include service bulletin information when available.

Please send all correspondence regarding Operations Manual Bulletins status to one of the following addresses:

Boeing Commercial Airplanes  
Commercial Aviation Services  
Attn: 757 Manager, Flight Technical Data  
P.O. Box 3707, M/C 20-89  
Seattle, Washington, 98124-2207 USA  
Telephone: (206) 662-4000  
Fax: (206) 662-4743



# Flight Crew Operations Manual Bulletin for The Boeing Company

The Boeing Company  
Seattle, Washington 98124-2207



**Number:** TBC-53 R1

**IssueDate:** November 27, 2007

## **Airplane Effectivity: All Airplanes**

**Subject:** Honeywell Flight Management Computer (FMC) Anomaly

**Reason:** To inform flight crews of a Honeywell FMC anomaly that incorrectly deletes a speed constraint.

Re-issued bulletin to ensure proper distribution.

Information in this bulletin is recommended by The Boeing Company, but may not be FAA approved at the time of writing. In the event of conflict with the FAA approved Airplane Flight Manual (AFM), the AFM shall supersede. The Boeing Company regards the information or procedures described herein as having a direct or indirect bearing on the safe operation of this model airplane.

THE FOLLOWING PROCEDURE AND/OR INFORMATION IS EFFECTIVE UPON RECEIPT

## **Background Information**

Boeing has confirmed operator reports of a Honeywell FMC anomaly that incorrectly deletes a speed constraint. Some SIDs are designed to limit turn radius to maintain clearance with other traffic or restricted airspace. Some of these procedures also have an AT-OR-ABOVE altitude restriction in conjunction with the speed constraint. Typically, the airplane will be required to limit speed until passing the respective waypoint as well as climb above the altitude constraint. In these procedures, VNAV will incorrectly delete the speed constraint prior to reaching the waypoint if the altitude constraint has been satisfied. When this happens, VNAV will command speed to accelerate to ECON speed (or SEL speed) prior to reaching the constrained waypoint. This anomaly exists on all Boeing 747 / 757 / 767 / 777 airplanes equipped with the Honeywell FMC.

Honeywell is aware of this anomaly. A software fix for 757 / 767 Pegasus is being considered for a future software update. For non-Pegasus, this bulletin will be incorporated in a future revision of the FCOM.

## Operating Instructions

To prevent exceeding a speed restriction when accompanied by an AT-OR-ABOVE altitude constraint, use speed intervention (enter speed constraint in the MCP Speed Window) until the constrained waypoint is sequenced. After passing the waypoint, select VNAV as desired.

---

## Administrative Information

Insert this bulletin behind the Operations Manual Bulletin Record page in Volume 1 of your Operations Manual. Amend the Operations Manual Bulletin Record to show bulletin TBC-53 R1 "In Effect" (IE).

This Flight Crew Operations Manual Bulletin will be revised to include service bulletin information when available.

Please send all correspondence regarding Operations Manual Bulletins status to one of the following addresses:

Boeing Commercial Airplanes  
Commercial Aviation Services  
Attn: 757 Manager, Flight Technical Data  
P.O. Box 3707, M/C 20-89  
Seattle, Washington, 98124-2207 USA  
Telephone: (206) 662-4000  
Fax: (206) 662-4743





# Flight Crew Operations Manual Bulletin for The Boeing Company

The Boeing Company  
Seattle, Washington 98124-2207



**Number:** TBC-54

**IssueDate:** March 10, 2008

## **Airplane Effectivity: All Airplanes**

**Subject:** Missing Advisory-Level Message Logic in EICAS Computer P/N S242N701-1001 Operating Program Software (OPS) Version 6

**Reason:** To inform flight crews of missing EICAS OPS Version 6 advisory-level message logic and to provide temporary operating instructions with OPS Version 6 installed.

Information in this bulletin is recommended by The Boeing Company, but may not be FAA approved at the time of writing. In the event of conflict with the FAA approved Airplane Flight Manual (AFM), the AFM shall supersede. The Boeing Company regards the information or procedures described herein as having a direct or indirect bearing on the safe operation of this model airplane.

THE FOLLOWING PROCEDURE AND/OR INFORMATION IS EFFECTIVE UPON RECEIPT

## **Background Information**

Boeing and Rockwell Collins have confirmed the EICAS advisory-level "L ENG FUEL FILT" alert message is not available on airplanes installed with EICAS computer P/N S242N701-1001 with Operating Program Software (OPS) Version 6. This software version is installed by incorporation of Boeing Service Bulletin 757-31-0159, or production equivalent.

Each engine fuel system is equipped with a filter to remove contaminants and a pressure relief valve to allow bypass of an obstructed filter element. A pressure differential switch provides EICAS alerting of filter element obstruction prior to pressure relief valve actuation and filter bypass. Contaminants in the fuel system may result in erratic engine operation and flameout.

The EICAS advisory-level "L ENG FUEL FILT" alert message indicates an impending fuel filter bypass condition exists on the left engine. In addition, a status-level "L ENG FUEL FILT" message shows on the EICAS Status page. The STATUS Cue indication appears anytime a new status message exists with the EICAS Status page not displayed.

Boeing has been notified by the Federal Aviation Administration (FAA) Aircraft Certification Office (ACO) that an Immediate Adopted Rule (IAR) is being drafted, which will result in imminent issuance of an Airworthiness Directive (AD) regarding this missing advisory-level message.

---

## Operating Instructions

In the interim period with EICAS OPS Version 6 installed, the following temporary operating instructions are provided:

If the STATUS Cue shows anytime on the ground after engine start or during flight, select the Status Page on the secondary EICAS display, and verify the "L ENG FUEL FILT" message is not shown. If the "L ENG FUEL FILT" message is not shown on the Status Page, the secondary engine parameters may be reselected on the secondary EICAS display, or the display may be blanked. If the "L ENG FUEL FILT" message is shown on the Status Page, accomplish the ENGINE FUEL FILTER non-normal checklist as published in the Boeing Quick Reference Handbook (QRH). If on the ground, check the Dispatch Deviations Guide (DDG), or operator equivalent.

In the unlikely event the status-level "L ENG FUEL FILT" and advisory-level "R ENG FUEL FILT" messages are simultaneously shown, an impending fuel filter bypass condition exists on both engines. With both messages shown, airplane system fuel contamination may be present and may result in erratic engine operation and flameout.

Further flight crew action in response to either or both the "L ENG FUEL FILT" status-level message and the "R ENG FUEL FILT" advisory-level messages being shown are not established by Boeing or the FAA. Any further flight crew action should be determined by individual operator policy.

Boeing policy on flight crew use of status-level messages has not changed. After engine start, any condition having adverse effect on safe continuation of the flight appears as an EICAS alert message (Warning, Caution, or Advisory). If other status-level messages are shown as a consequence of complying with these temporary operating instructions, the flight crew should respond in accordance with the appropriate operator policy.

---

## Administrative Information

Insert this bulletin behind the Operations Manual Bulletin Record page in Volume 1 of your Operations Manual. Amend the Operations Manual Bulletin Record to show bulletin TBC-54 "In Effect" (IE).

On airplanes with EICAS OPS Version 6 installed, the effects of this Flight Crew Operations Manual Bulletin are immediately corrected by incorporation of EICAS OPS Version 5 by either of the following applicable actions:

- (1) On airplanes of cumulative line (C/L) number 1013 or earlier, installation of Boeing Service Bulletin 757-31-0104 for 757-200 series airplanes and 757-31-0105 for 757-300 series airplanes; **or**,
- (2) On airplanes of cumulative line (C/L) number 1014 and greater, installation per Airplane Maintenance Manual (AMM) 31-41-02/201.

Boeing has directed Rockwell Collins to develop an EICAS software modification to correct the missing EICAS alert message logic in EICAS OPS Version 6. This Flight Crew Operations Manual Bulletin will be revised to include the Service Bulletin information of the future EICAS OPS Version modification when available.

This Flight Crew Operations Manual Bulletin will be "Cancelled" (CANC) upon operator notification to Boeing that all affected airplanes covered in this Flight Crew Operations Manual have been modified replacing EICAS OPS Version 6. EICAS OPS Version 6 can be replaced either by the applicable action listed above, or by incorporation of the future EICAS OPS Version, when available.

Please send all correspondence regarding Operations Manual Bulletins status to one of the following addresses:

Boeing Commercial Airplanes  
Commercial Aviation Services  
Attn: 757 Manager, Flight Technical Data  
P.O. Box 3707, M/C 20-89  
Seattle, Washington, 98124-2207 USA  
Telephone: (206) 662-4000  
Fax: (206) 662-4743

Intentionally  
Blank



# Flight Crew Operations Manual Bulletin for The Boeing Company

The Boeing Company  
Seattle, Washington 98124-2207



**Number:** TBC-56

**IssueDate:** July 27, 2009

## **Airplane Effectivity: All Airplanes**

**Subject:** Performance Adjustments for Thrust Shortfall of PW2000 Series Powered Airplanes with Cutback Fan Blades Installed

**Reason:** To provide subject adjustments for the Performance Inflight (PI) chapter in conjunction with the AFM appendix release.

Information in this bulletin is recommended by The Boeing Company, but may not be FAA approved at the time of writing. In the event of conflict with the FAA approved Airplane Flight Manual (AFM), the AFM shall supersede. The Boeing Company regards the information or procedures described herein as having a direct or indirect bearing on the safe operation of this model airplane.

THE FOLLOWING PROCEDURE AND/OR INFORMATION IS EFFECTIVE UPON RECEIPT

## **Background Information**

This bulletin advises operators of revised performance information applicable to the 757-200 with Pratt & Whitney PW2000 engines equipped with Cutback Fan Blades. PW2000 series engines equipped with 3 or more pairs of Cutback Fan Blades that have accumulated greater than 1000 cycles since new or since fan blade leading edge contour restoration refurbishment per Pratt & Whitney Service Bulletin PW2000 72-729 have been shown to be subject to thrust degradation. PW2000 engines equipped with 1 or 2 pairs of Cutback Fan Blades are not subject to this effect.

## **Operating Instructions**

The following airplane performance adjustments apply when operating with PW2000 engines equipped with 3 or more pairs of Cutback Fan Blades that have accumulated greater than 1000 cycles since new or refurbishment.

Reductions to the applicable performance limit weights are provided in the tables below. Takeoff speeds are not changed.

**Alternate N1 Mode**

WEIGHT (LB)	FIELD (LB)	CLIMB (LB)	OBSTACLE (LB)	GEAR DOWN CLIMB (LB)	GEAR DOWN OBSTACLE (LB)	NET LEVEL OFF (LB)	APPROACH/ LANDING CLIMB (LB)
273000	8350	14300	15350	14500	14850	15150	14600
270000	8250	14150	15200	14350	14700	14950	14400
260000	8000	13600	14800	13800	14350	14400	13850
255000	8000	13350	14850	13550	14350	14150	13600
250000	7850	13100	14650	13250	14350	13850	13300
240000	7550	12550	14250	12700	14350	13300	12750
230000	7200	12050	13800	12150	14350	12750	12200
220000	6900	11500	13350	11650	14350	12200	11650
210000	6600	11000	12950	11100	13600	11650	11100
200000	6250	10450	12500	10550	12800	11100	10550
190000	5950	9950	12050	10000	12050	10550	10000
180000	5650	9400	11650	9450	11300	10050	9450
170000	5350	8850	11200	8900	10550	9600	8850
160000	5100	8350	10750	8400	10000	9150	8300
150000	4800	7800	10350	7850	9550	8700	7750
140000	4500	7300	9900	7300	9100	8250	7200

**Alternate N1 Mode**

WEIGHT (KG)	FIELD (KG)	CLIMB (KG)	OBSTACLE (KG)	GEAR DOWN CLIMB (KG)	GEAR DOWN OBSTACLE (KG)	NET LEVEL OFF (KG)	APPROACH/ LANDING CLIMB (KG)
124000	3800	6500	7000	6600	6750	6900	6650
120000	3700	6300	6800	6400	6600	6650	6400
115660	3650	6050	6750	6150	6500	6450	6150
110000	3450	5750	6500	5850	6500	6100	5850
100000	3150	5250	6100	5300	6500	5550	5300
90000	2850	4700	5650	4750	5800	5000	4750
80000	2550	4200	5200	4200	5000	4500	4200
70000	2250	3650	4800	3650	4450	4050	3650
60000	1950	3150	4350	3150	4000	3600	3100

The following adjustments to the Altitude Capability and Fuel Requirements apply when operating with PW2000 engines equipped with 3 or more pairs of Cutback Fan Blades that have accumulated greater than 1000 cycles since new or refurbishment.

Reduce Long Range Cruise Maximum Operating Altitude by 1000 ft.

Reduce Engine Inoperative Long Range Cruise Altitude Capability by 3000 ft.

Reduce Gear Down Long Range Cruise Altitude Capability by 1300 ft.

Reduce Engine Inoperative Gear Down Long Range Cruise Altitude Capability by 2900 ft.

Increase Driftdown/LRC Cruise Range Capability fuel required by 1%.

## **Administrative Information**

Insert this bulletin behind the Operations Manual Bulletin Record page in Volume 1 of your Operations Manual. Amend the Operations Manual Bulletin Record to show bulletin TBC-56 "In Effect" (IE).

Please send all correspondence regarding Operations Manual Bulletins status to one of the following addresses:

Boeing Commercial Airplanes  
Commercial Aviation Services  
Attn: 757 Manager, Flight Technical Data  
P.O. Box 3707, M/C 20-89  
Seattle, Washington, 98124-2207 USA  
Telephone: (206) 662-4000  
Fax: (206) 662-4743

Intentionally  
Blank





# Flight Crew Operations Manual Bulletin for The Boeing Company

The Boeing Company  
Seattle, Washington 98124-2207



**Number:** TBC-57

**IssueDate:** December 23, 2009

## **Airplane Effectivity: All Airplanes**

**Subject:** Replacement of STANDBY BUS OFF Quick Reference Handbook (QRH) Checklist.

**Reason:** To provide a revised "STANDBY BUS OFF" procedure (Chapter NNC - Section 6) for the Quick Reference Handbook (QRH).

Information in this bulletin is recommended by The Boeing Company, but may not be FAA approved at the time of writing. In the event of conflict with the FAA approved Airplane Flight Manual (AFM), the AFM shall supersede. The Boeing Company regards the information or procedures described herein as having a direct or indirect bearing on the safe operation of this model airplane.

THE FOLLOWING PROCEDURE AND/OR INFORMATION IS EFFECTIVE UPON RECEIPT

## **Background Information**

An electrical system failure event was recently confirmed by Boeing, the National Transportation Safety Board (NTSB), and the Federal Aviation Administration (FAA) regarding the partial loss of the DC-powered electrical bus system on a 757 airplane. The information provided by this Flight Crew Operations Manual Bulletin (FCOMB) is related to FAA Safety Alert Flight Operations (SAFO) 09001, Subject: Effects of Electrical Faults Resulting in Main Battery Depletion, Dated: January 13, 2009.

The failure event resulted in the loss of all equipment solely powered by the main airplane battery even though power to both AC buses was available. Boeing and the FAA have determined interim corrective action is needed for all 757 airplanes to mitigate the occurrence of this specific failure event.

During normal operation with the Standby Power selector in the AUTO position, the AC buses supply power to the battery and standby DC buses through a transformer-rectifier unit and to the standby AC bus. The main battery charger, powered by the ground service bus, provides DC power to the hot battery bus. If the Standby Power selector is in the BAT position, the battery charger is disabled and the main battery becomes the sole source of electrical power to all equipment powered from the hot battery bus, the battery bus, the standby DC bus, and the standby AC bus. On some airplanes, the APU battery is paralleled to the main battery, which provides increased time these buses can be powered with the Standby Power selector in the BAT position.

The Quick Reference Handbook (QRH) replacement pages provided by this FCOMB provide either one or two revised STANDBY BUS OFF checklists, depending upon the operator's fleet configuration of the alternate stabilizer trim control system. This STANDBY BUS OFF checklist(s) contains the recommend flight crew guidance in the event the STANDBY BUS OFF advisory-level alert message is shown on EICAS.

Boeing will be issuing Service Bulletin 757-24-0132 during or before 3rd-quarter 2010. This service bulletin will be applicable to all 757 variant airplanes and will provide an FAA-approved retrofit kit of parts to bypass the battery-charger cutout with the Standby Power selector in the BAT position during flight.

The QRH replacement pages provided by this FCOMB are valid for use on airplane configurations both unmodified and modified by this service bulletin in a mixed-fleet configuration. When an operator reports to Boeing that all 757 airplanes have been modified by Service Bulletin 757-24-0132, a final revised STANDBY BUS OFF checklist will be issued to the operator's Boeing-published QRH that is compatible to a pure-fleet, SB-modified 757 configuration. This eliminates FAA and Boeing concerns of multiple STANDBY BUS OFF checklists being contained within an operators QRH, or operator equivalent, and the flight crew potential of erroneously accomplishing a STANDBY BUS OFF checklist not compatible with the airplane wiring configuration.

**IMPORTANT: All operators are reminded to properly report all Service Bulletin incorporation to Boeing in a timely manner. This will ensure proper manual pages are provided commensurate with the reported airplane fleet configuration.**

## **Administrative Information**

Insert this bulletin behind the Operations Manual Bulletin Record page in Volume 1 of your Operations Manual. Amend the Operations Manual Bulletin Record to show bulletin TBC-57 "Incorporated" (INC).

The effects of this Flight Crew Operations Manual Bulletin (FCOMB) are further modified by pure-fleet incorporation within an operator's fleet of Boeing Service Bulletin 757-24-0132. This Flight Crew Operations Manual Bulletin will be "CANCELLED" (CANC) upon operator notification to Boeing that all affected airplanes covered in this Flight Crew Operations Manual have been modified by Boeing Service Bulletin 757-24-0132.

Please send all correspondence regarding Operations Manual Bulletins status to one of the following addresses:

Boeing Commercial Airplanes  
Commercial Aviation Services  
Attn: 757 Manager, Flight Technical Data  
P.O. Box 3707, M/C 20-89  
Seattle, Washington, 98124-2207 USA  
Telephone: (206) 662-4000  
Fax: (206) 662-4743

Intentionally  
Blank

**Operating Limitations . . . . . L.10**

- General . . . . . L.10.1
- Airplane General . . . . . L.10.1
  - Operational Limitations . . . . . L.10.1
  - Non-AFM Operational Information . . . . . L.10.1
- Airplane Weight Restrictions . . . . . L.10.2
- Flight Deck Security Door . . . . . L.10.2
- Door Mounted Escape Slides . . . . . L.10.3
- Air Conditioning . . . . . L.10.3
- Auto Flight . . . . . L.10.3
- Aircraft Communications Addressing and Reporting System (ACARS) . . . . . L.10.3
- Engine . . . . . L.10.4
- Engine Fuel System . . . . . L.10.4
- Reverse Thrust . . . . . L.10.4
- Flight Controls . . . . . L.10.4
- Navigation . . . . . L.10.4
- Warning systems . . . . . L.10.5
  - Ground Proximity Warning System (GPWS)  
Look-Ahead Alerting . . . . . L.10.5

Intentionally  
Blank

#### General

This chapter contains Airplane Flight Manual (AFM) limitations and Boeing recommended operating limitations. Limitations that are obvious, shown on displays or placards, or incorporated within an operating procedure are not contained in this chapter.

#### Airplane General

#### Operational Limitations

Runway slope	± 2%
Maximum Operating Altitude	42,000 feet pressure altitude
Maximum Takeoff and Landing Altitude	8,400 feet pressure altitude
Maximum Takeoff and Landing Tailwind Component	10 knots

#### Non-AFM Operational Information

**Note:** The following items are not AFM limitations, but are provided for flight crew information.

Turbulent air penetration speed is: 290 KIAS/.78 Mach, whichever is lower.

The navigation and display system does not support operations at latitudes greater than 87° North or South.

Do not operate HF radios during refueling operations.

## RVSM Altimeter Cross Check Limits

Standby altimeters do not meet altimeter accuracy requirements of RVSM.

The maximum allowable in-flight difference between Captain and First Officer altitude displays for RVSM operations is 200 feet.

The maximum allowable on-the-ground differences between Captain and First Officer altitude displays for RVSM operation are:

Field Elevation	Max Difference Between Captain & F/O	Max Difference Between Captain or F/O & Field Elevation
SEA LEVEL	40 feet	75 feet
5,000 feet	45 feet	75 feet
10,000 feet	50 feet	75 feet

## Weather Radar

Do not operate the weather radar in a hangar or within 50 feet of any personnel or fuel spill.

**Note:** The hangar and personnel restrictions do not apply to the weather radar test mode.

## Airplane Weight Restrictions

### Maximum Weight Limitations

Weights	Pounds
Maximum Taxi Weight (MTW)	221,000
Maximum Take Off Weight (MTOW)	220,000
Maximum Landing Weight (MLW)	198,000
Maximum Zero Fuel Weight (MZFW)	184,000

### Other Weight Restrictions

**Note:** These weights may be further restricted by field length limits, climb limits, tire speed limits, brake energy limits, obstacle clearance, or enroute and landing requirements.

## Flight Deck Security Door

**(SB Adds BC001, BC002 when enhanced security flight deck door installed.)**

Verify that an operational check of the Flight Deck Access System has been accomplished according to approved procedures once each flight day.



---

## Door Mounted Escape Slides

Entry door evacuation slide systems must be armed and engagement of the girt bar with door sill verified prior to taxi, takeoff, or landing whenever passengers are carried.

---

## Air Conditioning

When the airplane is electrically powered for more than 20 minutes on the ground, equipment cooling must be provided as shown below.

Temp. (OAT)	COOLING REQUIRED
34° C to 40° C (94° F to 105° F)	One forward and one aft entry door on opposite sides open, or at least one A/C pack or equivalent ground cooling operating.
41° C to 49° C (106° F to 120° F)	At least one A/C pack or equivalent ground cooling operating.
More than 49° C (120° F)	Two A/C packs or equivalent ground cooling operating.

---

## Auto Flight

After takeoff, the autopilot must not be engaged below 200 feet AGL.

Use of aileron trim with the autopilot engaged is prohibited.

Maximum allowable wind speeds when landing weather minima are predicated on autoland operations:

[Option – 10 Knot tailwind ]

Headwind	25 knots
Crosswind	25 knots
Tailwind	10 knots

---

## Aircraft Communications Addressing and Reporting System (ACARS)

ACARS is limited to the transmission and receipt of messages which will not create an unsafe condition if the message is improperly received, such as the following conditions:

- the message or parts of the message are delayed or not received,
- the message is delivered to the wrong recipient, or
- the message content may be frequently corrupted.

---

However, Pre-Departure, Digital Automatic Terminal Information Service, Oceanic Clearances, Weight and Balance and Takeoff Data messages can be transmitted and received over ACARS if they are verified per approved operational procedures.

---

## Engine

Continuous ignition must be on (engine start selector in the CONT position) while operating in severe turbulence.

**Note:** Continuous ignition is automatically provided in icing conditions when engine anti-ice is on.

Flight crew shall not blank engine vibration display during takeoff.

---

## Engine Fuel System

The maximum fuel temperature is 49° C (120° F) {JP4/Jet B: 29° C (84° F)}.

The maximum fuel temperature is 49° C (120° F).

The minimum fuel temperature is minus 45° C (minus 49° F) or 3° C (5° F) above the freeze point, whichever is higher.

The center tank may contain up to 2000 pounds of fuel with less than full main tanks provided center tank fuel weight plus actual zero fuel weight does not exceed the maximum zero fuel weight, and center of gravity limits are observed.

---

## Reverse Thrust

Reverse thrust is for ground use only.

[\[Option – Applies to Pratt and Whitney engine thrust reversers\]](#)

Backing the airplane with use of reverse thrust is prohibited.

---

## Flight Controls

The maximum altitude for flap extension is 20,000 ft.

Avoid rapid and large alternating control inputs, especially in combination with large changes in pitch, roll, or yaw (e.g. large side slip angles) as they may result in structural failure at any speed, including below VA.

---

## Navigation

[\[Options: Extended magnetic variation tables or not.\]](#)

Do not operate under IFR or at night into airports north of 73° North or south of 60° South latitude whose navigation aids are referenced to magnetic north.

---

---

---

## Warning systems

### Ground Proximity Warning System (GPWS) Look-Ahead Alerting

Do not use the terrain display for navigation.

The use of look-ahead terrain alerting and terrain display functions is prohibited within 15 nm of takeoff, approach or landing at an airport or runway not contained in the GPWS terrain database. Refer to Honeywell Document 060-4267-000 for airports and runways contained in the installed GPWS terrain database.

The use of look-ahead terrain alerting and terrain display functions is prohibited during QFE operations.

Intentionally  
Blank

### Normal Procedures

### Chapter NP

### Table of Contents

### Section 0

<b>Introduction</b> .....	<b>NP.11</b>
General .....	NP.11.1
Scan Flow and Areas of Responsibility .....	NP.11.1
Normal Procedures Philosophy and Assumptions .....	NP.11.2
Configuration Check .....	NP.11.3
Crew Duties .....	NP.11.4
Control Display Unit (CDU) Procedures .....	NP.11.5
Autopilot Flight Director System (AFDS) Procedures .....	NP.11.5
Preflight and Postflight Scan Flow .....	NP.11.6
Areas of Responsibility - Captain as Pilot Flying or Taxiing .....	NP.11.7
Areas of Responsibility - First Officer as Pilot Flying or Taxiing .....	NP.11.8
<b>Amplified Procedures</b> .....	<b>NP.21</b>
Preliminary Preflight Procedure – Captain or First Officer .....	NP.21.1
CDU Preflight Procedure – Captain and First Officer .....	NP.21.3
Exterior Inspection .....	NP.21.5
Preflight Procedure – First Officer .....	NP.21.11
Preflight Procedure – Captain .....	NP.21.20
Before Start Procedure .....	NP.21.25
Pushback or Towing Procedure .....	NP.21.28
Engine Start Procedure .....	NP.21.29
Engine Start Procedure .....	NP.21.31
Before Taxi Procedure .....	NP.21.32
Before Takeoff Procedure .....	NP.21.34
Takeoff Procedure .....	NP.21.35

---

Takeoff Flap Retraction Speed Schedule . . . . .	NP.21.37
Climb and Cruise Procedure. . . . .	NP.21.38
Descent Procedure . . . . .	NP.21.39
Approach Procedure. . . . .	NP.21.40
Flap Extension Schedule . . . . .	NP.21.40
Landing Procedure - ILS . . . . .	NP.21.41
Landing Procedure - Instrument Approach Using VNAV . . . . .	NP.21.42
Go-Around and Missed Approach Procedure . . . . .	NP.21.44
Landing Roll Procedure . . . . .	NP.21.45
After Landing Procedure . . . . .	NP.21.46
Shutdown Procedure. . . . .	NP.21.47
Secure Procedure . . . . .	NP.21.49

---

## **General**

This chapter gives:

- an introduction to the normal procedures philosophy and assumptions
- step by step normal procedures

---

## **Scan Flow and Areas of Responsibility**

The scan flow and areas of responsibility diagrams shown are representative and may not match the configuration(s) of your airplanes.

The scan flow diagram provides general guidance on the order each flight crew member should follow when doing the preflight and postflight procedures. Specific guidance on the items to be checked are detailed in the amplified Normal Procedures. For example, preflight procedure details are in the Preflight Procedure - Captain and Preflight Procedure - First Officer.

## **Normal Procedures Philosophy and Assumptions**

Normal procedures verify for each phase of flight that:

- the airplane condition is satisfactory
- the flight deck configuration is correct

Normal procedures are done on each flight. Refer to the Supplementary Procedures (SP) chapter for procedures that are done as needed, for example the adverse weather procedures.

Normal procedures are used by a trained flight crew and assume:

- all systems operate normally
- the full use of all automated features (LNAV, VNAV, autoland, autopilot, and autothrottle)

Normal procedures also assume coordination with the ground crew before:

- hydraulic system pressurization, or
- flight control surface movement, or
- airplane movement

Normal procedures do not include steps for flight deck lighting and crew comfort items.

Normal procedures are done by memory and scan flow. The panel illustration in this section shows the scan flow. The scan flow sequence may be changed as needed.



## Configuration Check

It is the crew member's responsibility to verify correct system response. Before engine start, use lights or indications to verify each system's condition or configuration.

If there is an incorrect configuration or response:

- verify that the system controls are set correctly
- check the respective circuit breaker as needed. Maintenance must first determine that it is safe to reset a tripped circuit breaker on the ground
- test the respective system light as needed

Before engine start, review the EICAS alert messages and status display.

If there are unexpected messages:

- check the Dispatch Deviations Guide (DDG) or the operator equivalent to decide if the condition has a dispatch effect

If, during or after engine start, there is an alert message:

- do the respective non-normal checklist (NNC)
- on the ground, check the DDG or the operator equivalent

After engine start, EICAS alert messages are the primary means of alerting the flight crew to non-normal conditions or incorrect configurations.

After engine start, there is no need to check status messages. Any message that has an adverse affect on safe continuation of the flight appears as an EICAS alert message.

## Crew Duties

Preflight and postflight crew duties are divided between the captain and first officer. Phase of flight duties are divided between the Pilot Flying (PF) and the Pilot Monitoring (PM).

Each crewmember is responsible for moving the controls and switches in their area of responsibility:

- The phase of flight areas of responsibility for both normal and non-normal procedures are shown in the Area of Responsibility illustrations in this section. Typical panel locations are shown.
- The preflight and postflight areas of responsibility are defined by the "Preflight Procedure - Captain" and "Preflight Procedure - First Officer".

The captain may direct actions outside of the crewmember's area of responsibility.

The general PF phase of flight responsibilities are:

- taxiing
- flight path and airspeed control
- airplane configuration
- navigation

The general PM phase of flight responsibilities are:

- checklist reading
- communications
- tasks asked for by the PF
- monitoring taxiing, flight path, airspeed, airplane configuration, and navigation

PF and PM duties may change during a flight. For example, the captain could be the PF during taxi but be the PM during takeoff through landing.

Normal procedures show who does a step by crew position (C, F/O, PF, or PM):

- in the procedure title, or
- in the far right column, or
- in the column heading of a table

The mode control panel is the PF's responsibility. When flying manually, the PF directs the PM to make the changes on the mode control panel.

The captain is the final authority for all tasks directed and done.

## **Control Display Unit (CDU) Procedures**

Before taxi, the captain or first officer may make CDU entries. The other pilot must verify the entries.

Make CDU entries before taxi or when stopped, when possible. If CDU entries must be made during taxi, the PM makes the entries. The PF must verify the entries before they are executed.

In flight, the PM usually makes the CDU entries. The PF may also make simple, CDU entries when the workload allows. The pilot making the entries executes the change only after the other pilot verifies the entries.

During high workload times, for example departure or arrival, try to reduce the need for CDU entries. Do this by using the MCP heading, altitude, and speed control modes. The MCP can be easier to use than entering complex route modifications into the CDU.

---

## **Autopilot Flight Director System (AFDS) Procedures**

The crew must always monitor:

- airplane course
- vertical path
- speed

When selecting a value on the MCP, verify that the respective value changes on the flight instruments, as applicable.

The crew must verify manually selected or automatic AFDS changes. Use the FMA to verify mode changes for the:

- autopilot
- flight director
- autothrottle

During LNAV and VNAV operations, verify all changes to the airplane's:

- course
- vertical path
- thrust
- speed

Announcing changes on the FMA and thrust mode display when they occur is a good CRM practice.

## Preflight and Postflight Scan Flow

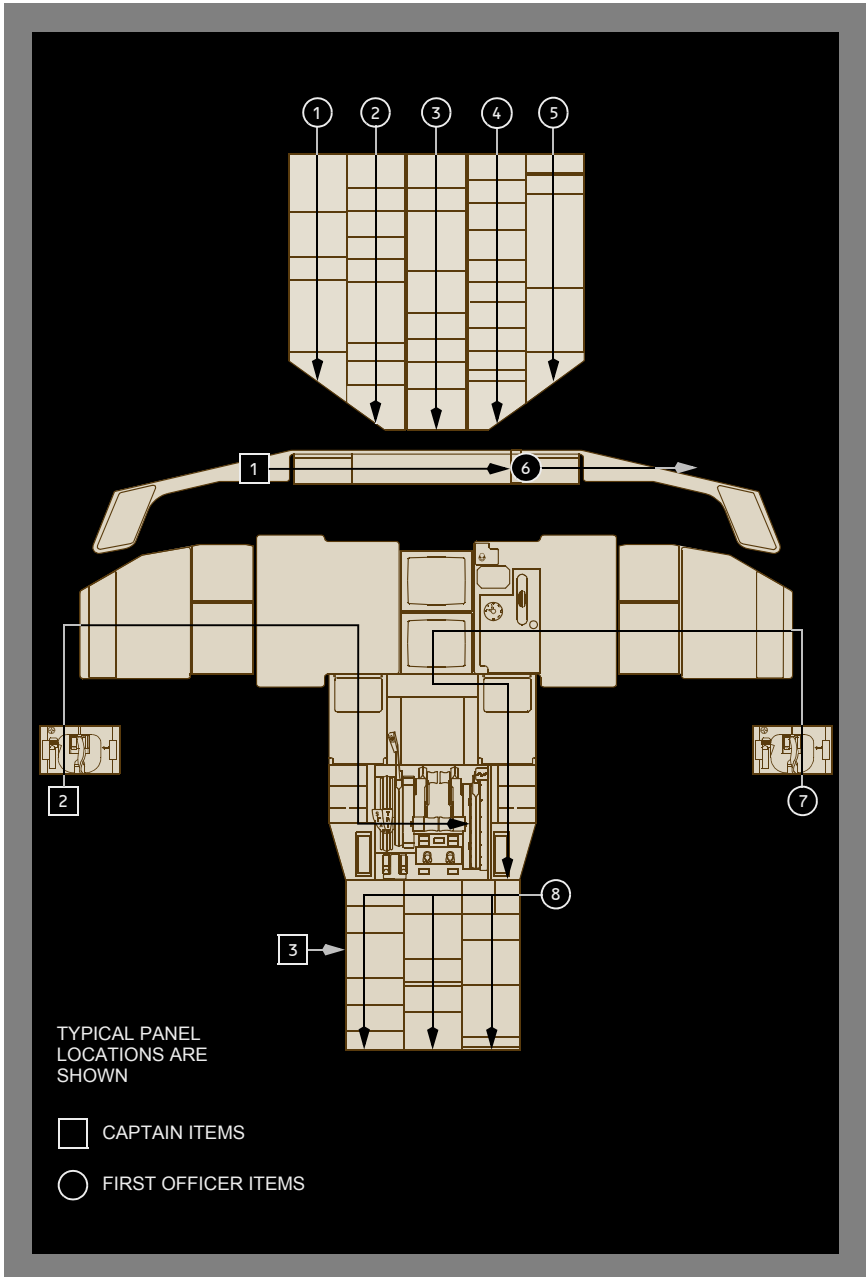

**Areas of Responsibility - Captain as Pilot Flying or Taxiing**

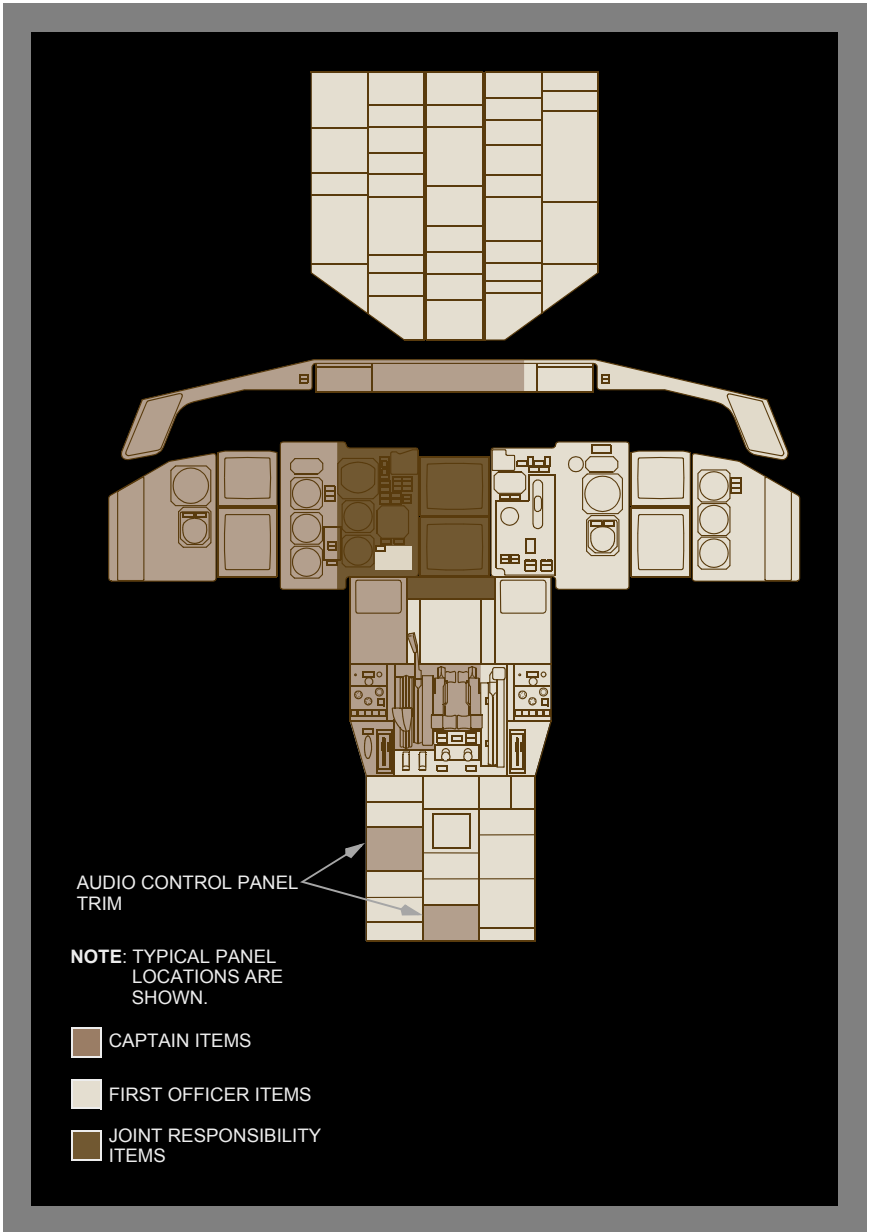

**Areas of Responsibility - First Officer as Pilot Flying or Taxiing**

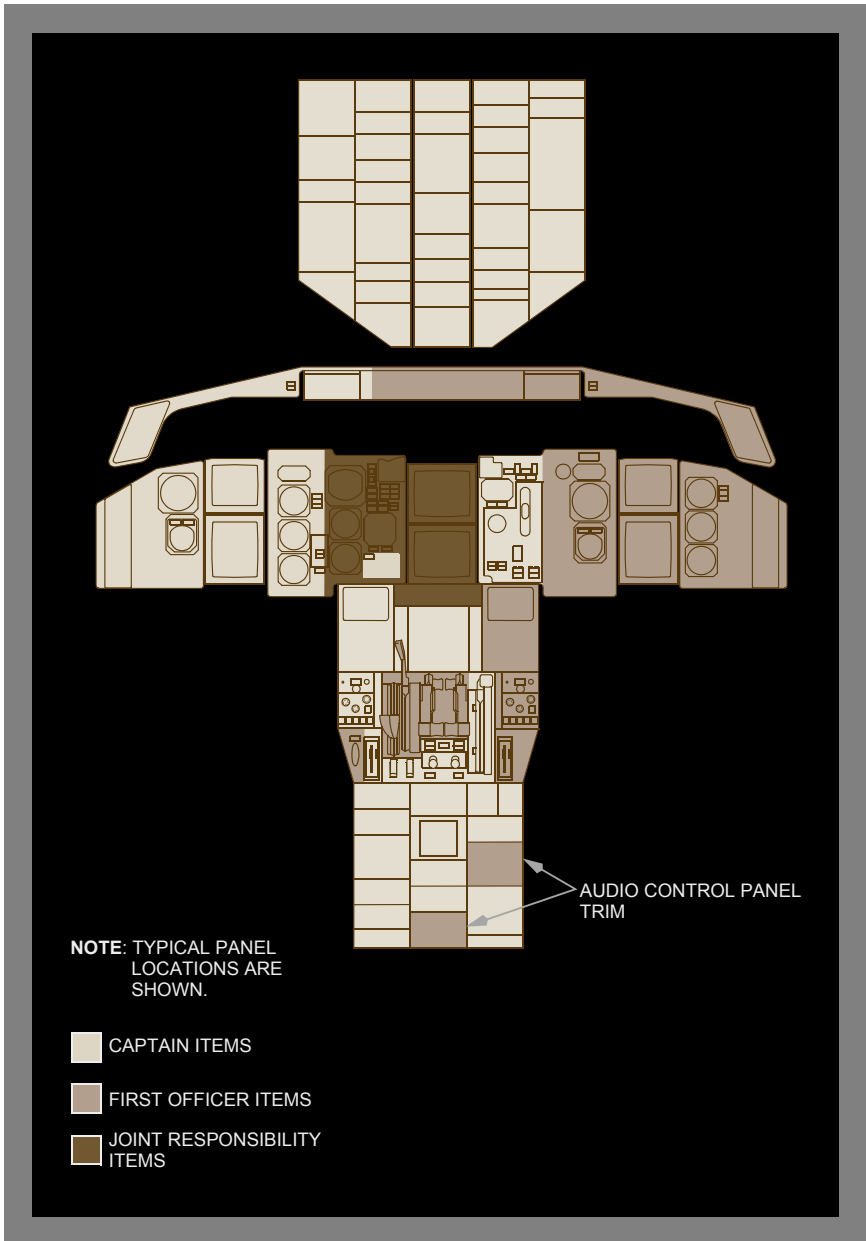

# DO NOT USE FOR FLIGHT

757 Flight Crew Operations Manual

Normal Procedures

Chapter NP

Amplified Procedures

Section 21

## Preliminary Preflight Procedure – Captain or First Officer

The Preliminary Preflight Procedure assumes that the Electrical Power Up supplementary procedure is complete.

IRS mode selectors .....OFF, then NAV

Verify that the ON DC lights illuminate then extinguish.

Verify that the ALIGN lights are illuminated.

STATUS display ..... Check

Verify that only expected messages are shown.

Verify that the following are sufficient for flight:

- oxygen pressure
- hydraulic quantity
- engine oil quantity

---

Do the remaining actions after a crew change or maintenance action.

Maintenance documents ..... Check

(SB Adds BC001, BC002 by adding the enhanced security type flight deck door (service bulletin incorporated).)

FLIGHT DECK ACCESS SYSTEM switch ..... Guard closed

POWER TRANSFER UNIT switch ..... Guard closed

FLIGHT RECORDER switch ..... NORM

SERVICE INTERPHONE switch ..... OFF

Circuit breakers ..... Check

Emergency equipment ..... Check

    Fire extinguisher – Checked and stowed

    Crash axe – Stowed

    Escape ropes – Stowed

    Other needed equipment – Checked and stowed

Parking brake ..... As needed

    Set the parking brake if brake wear indicators will be checked during the exterior inspection.



---

---

## CDU Preflight Procedure – Captain and First Officer

Start the CDU Preflight Procedure anytime after the Preliminary Preflight Procedure. The Initial Data and Navigation Data entries must be complete before the flight instrument check during the Preflight Procedure. The Performance Data entries must be complete before the Before Start Checklist.

The captain or first officer may make CDU entries. The other pilot must verify the entries.

Enter data in all the boxed items on the following CDU pages.

Enter data in the dashed items or modify small font items that are listed in this procedure. Enter or modify other items at pilot's discretion.

Failure to enter enroute winds can result in flight plan time and fuel burn errors.

Initial Data .....Set

IDENT page:

Verify that the MODEL is correct.

Verify that the navigation data base ACTIVE date range is current.

POS INIT page:

Verify that the time is correct.

Enter the present position on the SET IRS POS line. Use the most accurate latitude and longitude.

---

Navigation Data ..... Set

RTE page:

Enter the route.

Enter the FLIGHT NUMBER.

Activate and execute the route.

DEPARTURES page:

Select the runway and departure routing.

Execute the runway and departure routing.

POS REF page:

Verify or enter the correct RNP for the departure.

Verify that the route is correct on the RTE pages. Check the LEGS pages as needed to ensure compliance with the flight plan.

Performance Data ..... Set

PERF INIT page:

**CAUTION: Do not enter the ZFW into the GR WT boxes.  
The FMC will calculate performance data with  
significant errors.**

Enter the ZFW.

Verify that the FUEL on the CDU, the dispatch papers, and the fuel quantity indicator agree.

Verify that the fuel is sufficient for flight.

Verify that the GR WT on the CDU and the dispatch papers agree.

TAKEOFF REF page:

Enter the CG.

Enter the takeoff V speeds.

## Exterior Inspection

Before each flight the captain, first officer, or maintenance crew must verify that the airplane is satisfactory for flight.

Items at each location may be checked in any sequence.

Use the detailed inspection route below to check that:

- the surfaces and structures are clear, not damaged, not missing parts and there are no fluid leaks
- the tires are not too worn, not damaged, and there is no tread separation
- the gear struts are not fully compressed
- the engine inlets and tailpipes are clear, the access panels are secured, the exterior is not damaged, and the reversers are stowed
- the doors and access panels that are not in use are latched
- the probes, vents, and static ports are clear and not damaged
- the skin area adjacent to the pitot probes and static ports is not wrinkled
- the antennas are not damaged
- the light lenses are clean and not damaged
- each trailing edge flap is symmetrically retracted

For cold weather operations see the Supplementary Procedures.

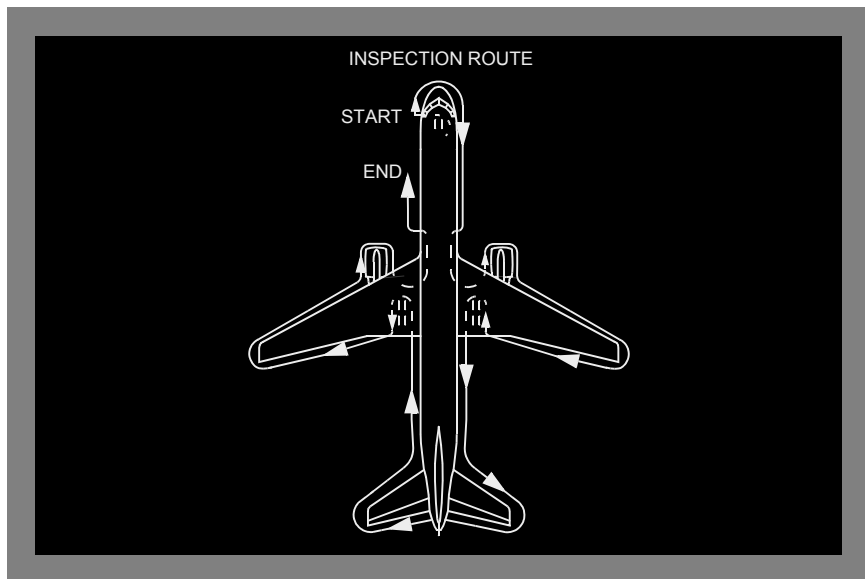

## **Left Forward Fuselage**

Probes, sensors, ports, vents, and drains (as applicable)..... Check  
Doors and access panels (not in use)..... Latched

## **Nose**

Radome ..... Check  
Diverter strips – Secure  
Forward access door ..... Secure

## **Nose Wheel Well**

Tires and wheels ..... Check  
Gear strut and doors ..... Check  
Nose wheel steering assembly ..... Check  
Nose gear steering lockout pin ..... As needed  
Gear pin ..... As needed  
Exterior lights ..... Check  
Nose wheel spin brake (snubbers)..... In place  
Wheel well light switches ..... As needed  
E/E access door ..... Secure

## **Right Forward Fuselage**

Probes, sensors, ports, vents, and drains (as applicable)..... Check  
Doors and access panels (not in use)..... Latched  
Oxygen pressure relief green disc ..... In place  
Negative pressure relief doors ..... Closed

**Right Wing Root, Pack, and Lower Fuselage**

- Probes, sensors, ports, vents, and drains (as applicable) ..... Check
- Exterior lights ..... Check
- Pack inlet and pneumatic access doors ..... Secure
- Leading edge slats ..... Check
- Fuel sticks ..... Flush and secure

**Right Engine**

- Access panels ..... Latched
- Probes, sensors, ports, vents, and drains (as applicable) ..... Check
- Fan blades, probes, and spinner ..... Check
- Thrust reverser ..... Stowed
- Exhaust area and tailcone ..... Check

**Right Wing and Leading Edge**

- Access panels ..... Latched
- Leading edge slats ..... Check
- Fuel sticks ..... Flush and secure
- Wing Surfaces ..... Check
- Fuel tank vent ..... Check

**Right Wing Tip and Trailing Edge**

- Position and anti-collision lights ..... Check
- Static discharge wicks ..... Check
- Aileron and trailing edge flaps ..... Check

---

## Right Main Gear

Tires, brakes and wheels ..... Check

Verify that the wheel chocks are in place as needed.

If the parking brake is set, the brake wear indicator pins must extend out of the guides.

Gear strut, actuators, and doors ..... Check

Hydraulic lines ..... Secure

Gear pin ..... As needed

## Right Main Wheel Well

Wheel well ..... Check

## Right Aft Fuselage

Ram air turbine door ..... Check

Doors and access panels (not in use)..... Latched

Probes, sensors, ports, vents, and drains (as applicable)..... Check

## Tail

Vertical stabilizer and rudder ..... Check

Horizontal stabilizer and elevator ..... Check

Static discharge wicks ..... Check

APU exhaust outlet ..... Check

## Left Aft Fuselage

Outflow valve ..... Check

Doors and access panels (not in use)..... Latched

Probes, sensors, ports, vents, and drains (as applicable)..... Check

Positive pressure relief valves ..... Closed

## Left Main Wheel Well

Wheel well ..... Check

**Left Main Gear**

Tires, brakes and wheels ..... Check

Verify that the wheel chocks are in place as needed.

If the parking brake is set, the brake wear indicator pins must extend out of the guides.

Gear strut, actuators and doors ..... Check

Hydraulic lines ..... Secure

Gear pin ..... As needed

**Left Wing Tip and Trailing Edge**

Position and anti-collision lights ..... Check

Static discharge wicks ..... Check

Aileron and trailing edge flaps ..... Check

Fuel tank vent ..... Check

**Left Wing and Leading Edge**

Wing Surfaces ..... Check

Fuel sticks ..... Flush and secure

Fuel tank vent ..... Check

Leading edge slats ..... Check

Access panels ..... Latched

**Left Engine**

Exhaust area and tailcone ..... Check

Thrust reverser ..... Stowed

Fan blades, probes, and spinner ..... Check

Probes, sensors, ports, vents, and drains (as applicable) ..... Check

Access panels ..... Latched

**Left Wing Root, Pack, and Lower Fuselage**

- Fuel sticks ..... Flush and secure
- Probes, sensors, ports, vents, and drains (as applicable)..... Check
- Exterior lights ..... Check
- Pack inlet and pneumatic access doors ..... Secure
- Leading edge slats ..... Check



---

---

## Preflight Procedure – First Officer

The first officer normally does this procedure. The captain may do this procedure as needed.

YAW DAMPER switches ..... ON

The INOP lights stay illuminated until IRS alignment is complete.

ELECTRONIC ENGINE CONTROL switches ..... ON

HYDRAULIC panel .....Set

Verify that the SYS PRESS lights are illuminated.

Left and Right ENGINE pump switches – ON

Verify that the PRESS lights are illuminated.

Left, Right, Center 1, and Center 2 ELECTRIC pump switches – Off

Verify that the PRESS lights are illuminated.

ELT switch ..... ARMED

Verify that the ON light is extinguished.

HF radio .....Set

BATTERY/STANDBY POWER CONTROL panel .....Set

BATTERY switch – ON

Verify that the DISCH light is extinguished.

STANDBY POWER selector – AUTO

Verify that the standby power bus OFF light is extinguished.

---

Electrical panel ..... Set

APU GENERATOR switch – ON

BUS TIE switches – AUTO

Verify that the AC BUS OFF lights are extinguished.

UTILITY BUS switches – ON

Verify that the OFF lights are extinguished.

GENERATOR CONTROL switches – ON

Verify that the OFF lights are illuminated.

Verify that the DRIVE lights are illuminated.

APU selector (as needed) ..... START, then ON

Do not allow the APU selector to spring back to the ON position.

Verify that the RUN light is illuminated.

Lighting panel ..... Set

RUNWAY TURNOFF light switches – OFF

[Option - with switch guard]

EMERGENCY LIGHTS switch ..... Guard closed

Verify that the UNARMED light is extinguished.

**Note:** Do not push the PASSENGER OXYGEN switch. The switch causes deployment of the passenger oxygen masks.

PASSENGER OXYGEN ON light ..... Verify extinguished

**WARNING: Do not push the RAM AIR TURBINE switch. The switch causes deployment of the ram air turbine.**

Ram air turbine UNLKD light ..... Verify extinguished

Engine control panel ..... Set

ENGINE LIMITER switches – ON

Verify that the INOP lights are extinguished.

Engine ignition selector – 1 or 2

- 
- Engine start selectors – AUTO
- FUEL panel .....Set
- CROSSFEED switches – Off
- Verify that the VALVE lights are extinguished.
- FUEL PUMP switches – Off
- Verify that the left forward pump PRESS light is extinguished if the APU is on or is illuminated if the APU is off.
- Verify that the other left and right pump PRESS lights are illuminated.
- Verify that both center pump PRESS lights are extinguished.
- ANTI-ICE panel .....Set
- WING anti-ice switch – Off
- ENGINE anti-ice switches – Off
- WIPER selector ..... OFF
- Lighting panel .....Set
- POSITION light switch – As needed
- ANTI-COLLISION light switches – Off
- WING light switch – As needed
- LANDING light switches – OFF
- WINDOW HEAT switches ..... ON
- Verify that the INOP lights are extinguished.
- HF radio .....Set
- PASSENGER SIGNS panel .....Set
- NO SMOKING selector – AUTO or ON
- SEATBELTS selector – AUTO or ON

---

CABIN ALTITUDE CONTROL panel .....	Set
AUTO RATE control – Index	
LANDING ALTITUDE selector – Destination airport elevation	
MODE SELECTOR – AUTO 1 or AUTO 2	
Alternate EQUIPMENT COOLING switch .....	Off
Air conditioning panel .....	Set
FLIGHT DECK and CABIN compartment temperature controls – AUTO	
Set as needed.	
The INOP lights stay illuminated until the trim air switch is ON.	
TRIM AIR switch – ON	
RECIRCULATION FAN switches – ON	
Verify that the INOP lights are extinguished.	
PACK CONTROL selectors – AUTO	
The PACK OFF lights stay illuminated until bleed air or external air is supplied.	
BLEED AIR panel .....	Set
ISOLATION switch – On	
Verify that the VALVE light is extinguished.	
ENGINE bleed air switches – ON	
Verify that the OFF lights are illuminated.	
APU bleed air switch – ON	
Verify that the VALVE light is extinguished.	
FLIGHT DIRECTOR switch .....	ON
VOR/DME switch .....	AUTO
Oxygen .....	Test and set
Select the status display.	

---

Oxygen mask – Stowed and doors closed

[Option: Oronasal face mask]

RESET/TEST switch – Push and hold

[Option: Scott face mask]

TEST AND RESET switch – Push and hold

Verify that the yellow cross shows momentarily in the flow indicator.

EMERGENCY/TEST selector – Push and hold

[Option: Oronasal face mask]

Continue to hold the RESET/TEST switch and push the EMERGENCY/TEST selector for 5 seconds. Verify that the yellow cross shows continuously in the flow indicator.

[Option: Scott face mask]

Continue to hold the TEST AND RESET switch and push the EMERGENCY/TEST selector for 10 seconds. Verify that the yellow cross shows continuously in the flow indicator.

Verify that the crew oxygen pressure does not decrease more than 100 psig.

If the oxygen cylinder valve is not in the full open position, pressure can:

- decrease rapidly, or
- decrease more than 100 psig, or
- increase slowly back to normal

[Option: Oronasal face mask]

Release the RESET/TEST switch and the EMERGENCY/TEST selector. Verify that the yellow cross does not show in the flow indicator.

[Option: Scott face mask]

Release the TEST AND RESET switch and the EMERGENCY/TEST selector. Verify that the yellow cross does not show in the flow indicator.

Normal/100% selector – 100%

Crew oxygen pressure – Check EICAS

Verify that the pressure is sufficient for dispatch.

---

INSTRUMENT SOURCE SELECT panel ..... Set

FLIGHT DIRECTOR source selector – R

[Option]

NAVIGATION instrument source selector – FMC R

ELECTRONIC FLIGHT INSTRUMENT switch – Off

INERTIAL REFERENCE SYSTEM switch – Off

AIR DATA source switch – Off

Do the Initial Data and Navigation Data steps from the CDU Preflight Procedure and verify that the IRS alignment is complete before checking the flight instruments.

Flight instruments ..... Check

Set the altimeter.

Verify that the flight instrument indications are correct.

Verify that only these flags are shown:

- TCAS
- V1 INOP until takeoff V-speeds are selected
- expected RDMI flags

Verify that the flight mode annunciations are correct:

- autothrottle mode is blank
- roll mode is TO
- pitch mode is TO
- AFDS status is FD

Select the map mode.

AUTOLAND STATUS annunciator ..... Check

Verify that the indications are blank.

Landing gear panel ..... Set

Landing gear lever – DN

ALTERNATE GEAR EXTEND switch – Guard closed

Ground proximity FLAP OVERRIDE switch ..... Off

Ground proximity GEAR OVERRIDE switch ..... Off

---

Ground proximity TERRAIN OVERRIDE switch ..... Off

HEADING REFERENCE switch ..... NORM

Alternate flaps panel ..... Set

ALTERNATE FLAPS selector – NORM

Alternate flaps switches – Off

EICAS display ..... Check

Upper EICAS display – Check

Verify that the primary engine indications show existing conditions.

Verify that no exceedance is shown.

Lower EICAS display – Check

Secondary ENGINE indications – Check

Verify that the secondary engine indications show existing conditions.

Verify that no exceedance is shown.

Select the status display.

Status messages – Check

COMPUTER selector – AUTO

THRUST REFERENCE SET selector – BOTH and in

Verify that the TO mode is shown.

---

EFIS control panel ..... Set

Decision height selector – As needed

TERRAIN switch – As needed

HSI RANGE selector – As needed

HSI TRAFFIC switch – As needed

HSI mode selector – MAP

HSI CENTER switch – As needed

WEATHER RADAR switch – Off

Verify that weather radar indications are not shown on the HSI.

MAP switches – As needed

Weather radar panel ..... Set

Left VHF communications panel ..... Set

ADF panel ..... Set

Center VHF communications panel ..... Set

Engine fire panel ..... Set

Verify that the ENG BTL 1 DISCH and ENG BTL 2 DISCH lights are extinguished.

Engine fire switches – In

Verify that the LEFT and RIGHT lights are extinguished.

Transponder panel ..... Set

ILS panel ..... As needed

CARGO FIRE panel ..... Set

CARGO FIRE ARM switches – Off

Verify that the FWD and AFT lights are extinguished.

Verify that the DISCH lights are extinguished.



---

APU fire panel .....Set

Verify that the APU BTL DISCH light is extinguished.

APU fire switch – In

Verify that the APU light is extinguished.

Right VHF communications radio .....Set

First officer’s audio control panel ..... As needed

**WARNING: Do not put objects between the seat and the aisle stand. Injury can occur when the seat is adjusted.**

Seat ..... Adjust

Adjust the seat for optimum eye reference.

[Option - Mechanical seats]

Verify a positive horizontal (fore and aft) seat lock.

Rudder pedals ..... Adjust

Adjust the rudder pedals to allow full rudder pedal and brake pedal movement.

Seat belt and shoulder harness ..... Adjust

Do the PREFLIGHT checklist on the captain’s command.

---

---

## Preflight Procedure – Captain

The captain normally does this procedure. The first officer may do this procedure if needed.

VOR/DME switch ..... AUTO

Mode control panel ..... Set

FLIGHT DIRECTOR switch – ON

AUTOTHROTTLE ARM switch – ARM

BANK LIMIT selector – As needed

Autopilot DISENGAGE bar – UP

Oxygen ..... Test and set

Select the status display.

Oxygen mask – Stowed and doors closed

[Option: Oronasal face mask]

RESET/TEST switch – Push and hold

[Option: Scott face mask]

TEST AND RESET switch – Push and hold

Verify that the yellow cross shows momentarily in the flow indicator.

EMERGENCY/TEST selector – Push and hold

[Option: Oronasal face mask]

Continue to hold the RESET/TEST switch and push the EMERGENCY/TEST selector for 5 seconds. Verify that the yellow cross shows continuously in the flow indicator.

[Option: Scott face mask]

Continue to hold the TEST AND RESET switch and push the EMERGENCY/TEST selector for 10 seconds. Verify that the yellow cross shows continuously in the flow indicator.

Verify that the crew oxygen pressure does not decrease more than 100 psig.

If the oxygen cylinder valve is not in the full open position, pressure can:

- decrease rapidly, or
- decrease more than 100 psig, or
- increase slowly back to normal

[Option: **Oronasal face mask**]

Release the RESET/TEST switch and the EMERGENCY/TEST selector. Verify that the yellow cross does not show in the flow indicator.

[Option: **Scott face mask**]

Release the TEST AND RESET switch and the EMERGENCY/TEST selector. Verify that the yellow cross does not show in the flow indicator.

Normal/100% selector – 100%

Crew oxygen pressure – Check EICAS

Verify that the pressure is sufficient for dispatch.

INSTRUMENT SOURCE SELECT panel .....Set

FLIGHT DIRECTOR source selector – L

[Option]

NAVIGATION instrument source selector – FMC L

ELECTRONIC FLIGHT INSTRUMENT switch – Off

INERTIAL REFERENCE SYSTEM switch – Off

AIR DATA source switch – Off

Do the Initial Data and Navigation Data steps from the CDU Preflight Procedure and verify that the IRS alignment is complete before checking the flight instruments.

---

Flight instruments ..... Check

Set the altimeter.

Verify that the flight instrument indications are correct.

Verify that only these flags are shown:

- TCAS
- V1 INOP until takeoff V-speeds are selected
- expected RDMI flags

Verify that the flight mode annunciations are correct:

- autothrottle mode is blank
- roll mode is TO
- pitch mode is TO
- AFDS status is FD

Select the map mode.

AUTOLAND STATUS annunciator ..... Check

Verify that the indications are blank.

RESERVE BRAKES switch ..... Off

Standby instruments ..... Check

Attitude indicator caging control – Pull, then release

ILS selector – OFF

Set the altimeter.

Verify that the flight instrument indications are correct.

Verify that no flags are shown.

Standby engine indicator selector ..... AUTO

AUTO BRAKES selector ..... RTO

EFIS control panel ..... Set

Decision height selector – As needed

TERRAIN switch – As needed

HSI RANGE selector – As needed

HSI TRAFFIC switch – As needed

HSI mode selector – MAP

HSI CENTER switch – As needed

WEATHER RADAR switch – Off

[Option - Momentary action switch]

Verify that weather radar indications are not shown on the HSI.

MAP switches – As needed

ALTERNATE STABILIZER TRIM switches ..... Neutral

SPEEDBRAKE lever ..... DOWN

Reverse thrust levers ..... Down

Forward thrust levers ..... Closed

Flap lever ..... Set

Set the flap lever to agree with the flap position.

Parking brake ..... Set

Verify that the PARK BRAKE light is illuminated.

**Note:** Do not assume that the parking brake will prevent airplane movement. Accumulator pressure can be insufficient.

STABILIZER TRIM cutout switches ..... Guards closed

FUEL CONTROL switches ..... CUTOFF

FUEL CONTROL switch fire warning lights ..... Verify extinguished

Captain's audio control panel ..... As needed

**WARNING: Do not put objects between the seat and the aisle stand. Injury can occur when the seat is adjusted.**

Seat ..... Adjust

Adjust the seat for optimum eye reference.

Verify a positive horizontal (fore and aft) seat lock.

Rudder pedals ..... Adjust

Adjust the rudder pedals to allow full rudder pedal and brake pedal movement.

Seat belt and shoulder harness ..... Adjust

Call "PREFLIGHT CHECKLIST."

---

---

## Before Start Procedure

Start the Before Start Procedure after papers are on board.

Flight deck door ..... Closed and locked F/O

(SB Deletes BC001, BC002 when new Enhanced Flight Deck security door is installed.)

FLIGHT DECK DOOR switch – Locked

Verify that the UNLKD light is extinguished.

[Option – New Door]

(SB Adds BC001, BC002 when new Enhanced Flight Deck security door is installed.)

Verify that the LOCK FAIL light is extinguished.

Do the CDU Preflight Procedure – Performance Data steps before completing this procedure.

CDU display ..... Set C, F/O

Normally the PF selects the TAKEOFF REF page.

Normally the PM selects the LEGS page.

Takeoff thrust reference ..... Set C, F/O

Verify that the thrust reference mode is correct.

IAS bugs ..... Set C, F/O

Set the bugs at V1, VR, VREF 30 + 40, and VREF 30 + 80.

MCP ..... Set C

IAS/MACH selector – Set V2

Arm LNAV as needed.

Initial heading – Set

Initial altitude – Set

Taxi and Takeoff briefings ..... Complete C, F/O

The pilot who will do the takeoff does the taxi and takeoff briefings.

Exterior doors ..... Verify closed F/O

---

Flight deck windows ..... Closed and locked C, F/O

Verify that the lock lever is in the forward, locked position.

Verify that the WINDOW NOT CLOSED decal does not show.

Start clearance ..... Obtain C, F/O

Obtain a clearance to pressurize the hydraulic systems.

Obtain a clearance to start the engines.

If pushback is needed:

Verify that the nose gear steering is locked out. C, F/O

HYDRAULIC panel.....Set F/O

**WARNING: If the tow bar is connected, do not pressurize the hydraulic systems until the nose gear steering is locked out. Unwanted tow bar movement can occur.**

**Note:** Pressurize the right system first to prevent fluid transfer between systems.

Right ELECTRIC pump switch – ON

Verify that the PRESS light is extinguished.

Center 1 and Center 2 ELECTRIC pump switches – ON

Verify that the center 1 PRESS light is extinguished.

The center 2 PRESS light stays illuminated until after the engine start because of load shedding.

Left ELECTRIC pump switch – ON

Verify that the PRESS light is extinguished.

Fuel panel .....Set F/O

LEFT and RIGHT FUEL PUMP switches – ON

Verify that the PRESS lights are extinguished.



If there is fuel in the center tank:

CENTER FUEL PUMP switches – ON

Verify both PRESS lights are illuminated and CTR L FUEL PUMP and CTR R FUEL PUMP messages are shown.

RED ANTI-COLLISION light switch ..... ON F/O

RECALL switch ..... Push F/O

Verify that only the expected alert messages are shown.

Trim ..... Set C

Stabilizer trim – \_\_\_ UNITS

Set the trim for takeoff.

Verify that the trim is in the greenband.

Aileron trim – 0 units

Rudder trim – 0 units

Call "BEFORE START CHECKLIST." C

Do the BEFORE START checklist. F/O

---

---

## Pushback or Towing Procedure

The Engine Start procedure may be done during pushback or towing.

Establish communications with ground handling personnel. C

**CAUTION: Do not hold or turn the nose wheel tiller during pushback or towing. This can damage the nose gear or the tow bar.**

**CAUTION: Do not use airplane brakes to stop the airplane during pushback or towing. This can damage the nose gear or the tow bar.**

Transponder ..... As needed F/O

At airports where ground tracking is not available, select STANDBY.  
At airports equipped to track airplanes on the ground, select an active transponder setting, but not a TCAS mode.

Set or release the parking brake as directed by ground handling personnel. C or F/O

When pushback or towing is complete:

Verify that the tow bar is disconnected C

Verify that the nose gear steering is not locked out C

---

---

## Engine Start Procedure

### [Option – Rolls Royce engines]

Select the secondary engine indications. F/O

PACK CONTROL selectors ..... OFF F/O

Verify that the PACK OFF lights are illuminated.

CANCEL switch ..... Push F/O

Verify that the messages are cancelled.

Start sequence ..... Announce C

Call "START \_\_\_ ENGINE" C

Engine start selector ..... GND F/O

Verify that the oil pressure increases. C, F/O

Verify N1 rotation, and N2 rotation. C, F/O

When N3 is at 25%, or (if 25% N3 is not possible), allow N3 to stabilize at maximum motoring at or above 15% N3, and,

When N2 is at 10%, or (if 10% is not possible), allow N2 to stabilize at maximum motoring:

**Note:** Maximum motoring occurs when N2 and N3 acceleration is less than 1% in approximately 5 seconds.

EGT 1° C or higher and less than 100° C:

FUEL CONTROL switch ..... RUN C

EGT 0° C

FUEL CONTROL switch ..... RICH C

Verify that the EGT increases and stays below the EGT limit. C, F/O

If RICH was used, when the engine is stabilized at idle:

FUEL CONTROL switch ..... RUN C

After the engine is stabilized at idle, start the other engine.

Do the ABORTED ENGINE START checklist for one or more of the following abort start conditions:

- the EGT does not increase by 20 seconds after the fuel control switch is moved to RICH or RUN
- the EGT quickly nears or exceeds the start limit
- the oil pressure indication is not normal by the time that the engine is stabilized at idle

---

---

## Engine Start Procedure

### [Option – Pratt and Whitney engines]

Select the secondary engine indications. F/O

PACK CONTROL selectors ..... OFF F/O

Verify that the PACK OFF lights are illuminated.

Start sequence ..... Announce C

Call "START \_\_\_ ENGINE" C

Engine start selector ..... GND F/O

Verify that the oil pressure increases. C, F/O

Verify N2 rotation. C, F/O

At maximum motoring and a minimum of 18% N2:

**Note:** Maximum motoring occurs when N2 acceleration is less than 1% in approximately 5 seconds.

FUEL CONTROL switch ..... RUN C

Verify that the EGT increases and stays below the EGT limit. C, F/O

Do not increase thrust above that needed to taxi until the oil temperature is a minimum of 50° C.

After the engine is stabilized at idle, start the other engine.

Do the ABORTED ENGINE START checklist for one or more of the following abort start conditions:

- the EGT does not increase by 20 seconds after the fuel control switch is moved to RUN
- there is no N1 rotation when the EGT increases
- the EGT quickly nears or exceeds the start limit
- the N2 is not at idle by 2 minutes after the fuel control switch is moved to RUN
- the oil pressure indication is not normal by the time that the engine is stabilized at idle

---

---

## Before Taxi Procedure

APU selector .....	OFF	F/O
ENGINE ANTI-ICE switches .....	As needed	F/O
PACK selectors .....	AUTO	F/O
ISOLATION switch .....	Off	F/O
Select the status display.		F/O
Verify that the ground equipment is clear.		C, F/O
Call "FLAPS___" as needed for takeoff.		C
Flap lever .....	Set takeoff flaps	F/O
Flight controls .....	Check	C

Make slow and deliberate inputs, one direction at a time.

Move the control wheel and the control column to full travel in both directions and verify:

- freedom of movement
- that the controls return to center
- correct flight control movement on the EICAS display

Hold the nose wheel tiller during the rudder check to prevent nose wheel movement.

Move the rudder pedals to full travel in both directions and verify:

- freedom of movement
- that the rudder pedals return to center
- correct flight control movement on the EICAS display

**[Option – Rolls Royce engines]**

Blank the lower EICAS display. F/O

**[Option – Pratt and Whitney engines]**

Select the secondary engine indications. F/O

Transponder .....

As needed	F/O
-----------	-----

At airports where ground tracking is not available, select STANDBY.

At airports equipped to track airplanes on the ground, select an active transponder setting, but not a TCAS mode.

Recall .....

Check	C, F/O
-------	--------

Verify that only expected alert messages are shown.

# **DO NOT USE FOR FLIGHT**

Normal Procedures -  
Amplified Procedures

## **757 Flight Crew Operations Manual**

---

Update changes to the taxi briefing, as needed.

C or PF

Call "BEFORE TAXI CHECKLIST."

C

Do the BEFORE TAXI checklist.

F/O

---

---

## Before Takeoff Procedure

[Option - PW engines]

Engine warm up **requirements:**

- engine oil temperature must be above 50 degrees C before takeoff.

[Option - PW engines]

Engine warm up recommendations (there is no need to delay the takeoff for these recommendations):

- when the engines have been shut down more than 4 hours:
  - run the engines for at least 5 minutes
- when taxi time is expected to be less than 5 minutes, start the engines as early as feasible
- use a thrust setting normally used for taxi operations.

[Option - RR engines]

Engine warm up **requirements:**

- when the engines have been shut down more than 1.5 hours:
  - run the engines for at least 5 minutes
- when the engines have been shut down less than 1.5 hours:
  - run the engines for at least 3 minutes
- use a thrust setting normally used for taxi operations
- engine oil temperature must be above the lower amber band before takeoff.

Pilot Flying	Pilot Monitoring
	[Passenger airplanes] Notify the cabin crew to prepare for takeoff. Verify that the cabin is secure.
The pilot who will do the takeoff updates changes to the takeoff briefing as needed.	
Set the weather radar display as needed. Set the terrain display as needed.	
Call "BEFORE TAKEOFF CHECKLIST."	Do the BEFORE TAKEOFF checklist.



## Takeoff Procedure

Pilot Flying	Pilot Monitoring
Before entering the departure runway, verify that the runway and runway entry point are correct.	
	When entering the departure runway, set the WHITE ANTI COLLISION light switch to ON. Use other lights as needed.  Set the transponder mode selector to TA/RA.
Verify that the brakes are released. Align the airplane with the runway.	
Verify that the airplane heading agrees with the assigned runway heading.	
	When cleared for takeoff, set the left and right WING LANDING light switches to ON.
Advance the thrust levers to approximately 1.10 EPR. Allow the engines to stabilize	
Push the EPR switch.	
Verify that the correct takeoff thrust is set.	
	Monitor the engine instruments during the takeoff. Call out any abnormal indications.  Adjust takeoff thrust before 80 knots as needed. During strong headwinds, if the thrust levers do not advance to the planned takeoff thrust by 80 knots, manually advance the thrust levers.
After takeoff thrust is set, the captain's hand must be on the thrust levers until V1.	
Monitor airspeed. Maintain light forward pressure on the control column.	Monitor airspeed and call out any abnormal indications.

Pilot Flying	Pilot Monitoring
Verify 80 knots and call "CHECK."	Call "80 KNOTS."
Verify V1 speed.	Call "V1."
At VR, rotate toward 15° pitch attitude. After liftoff, follow F/D commands.	At VR, call "ROTATE." Monitor airspeed and vertical speed.
Establish a positive rate of climb.	
	Verify a positive rate of climb on the altimeter and call "POSITIVE RATE."
Verify a positive rate of climb on the altimeter and call "GEAR UP."	
	Set the landing gear lever to UP.
Above 400 feet radio altitude, call for a roll mode as needed.	Select or verify the roll mode.
At thrust reduction height, call "VNAV."	
	Push the VNAV switch.
Verify that climb thrust is set.	
Verify acceleration. Call "FLAPS___" according to the flap retraction schedule.	
	Set the flap lever as directed.
Engage the autopilot after a roll mode and VNAV are engaged.	
	After flap retraction is complete: <ul style="list-style-type: none"> <li>• Set the landing gear lever to OFF after landing gear retraction is complete</li> </ul>
Call "AFTER TAKEOFF CHECKLIST."	
	Do the AFTER TAKEOFF checklist.

---

---

**Takeoff Flap Retraction Speed Schedule**

<b>Takeoff Flaps</b>	<b>At Speed (knots)</b>	<b>Select Flaps</b>
20 or 15	VREF 30 + 20	5
	"F" VREF 30 + 40	1
	"F" VREF 30 + 60	UP
5	"F" VREF 30 + 40	1
	"F" VREF 30 + 60	UP
1	"F" VREF 30 + 60	UP

"F" = Minimum flap retraction speed for next flap setting on speed tape display (as installed)

---

---

## Climb and Cruise Procedure

Complete the After Takeoff Checklist before starting the Climb and Cruise Procedure.

<b>Pilot Flying</b>	<b>Pilot Monitoring</b>
	At or above 10,000 feet MSL, set the LANDING light switches to OFF.
	Set the passenger signs as needed.
At transition altitude, set and crosscheck the altimeters to standard.	
	Refer to the Operating Instructions contained in Flight Crew Operations Manual Bulletin (FCOMB), Subject: "Center Tank Fuel Pumps."
	Before the top of descent, modify the active route as needed for the arrival and approach.  Verify or enter the correct RNP for the arrival.

---

---

## Descent Procedure

Start the Descent Procedure before the airplane descends below the cruise altitude for arrival at destination.

Complete the Descent Procedure by 10,000 feet MSL.

Pilot Flying	Pilot Monitoring
	Verify that pressurization is set to landing altitude.
Review all alert messages.	Recall and review all alert messages.
Verify VREF on the APPROACH REF page.	Enter VREF on the APPROACH REF page.
Set the bugs at VREF, VREF 30 + 40, and VREF 30 + 80.	
Set the RADIO/BARO minimums as needed for the approach.	
Set or verify the navigation radios and course for the approach.	
	Set the AUTO BRAKES selector to the needed brake setting
Do the approach briefing.	
Call "DESCENT CHECKLIST."	Do the DESCENT checklist.

## Approach Procedure

The Approach Procedure is normally started at transition level.

Complete the Approach Procedure before:

- the initial approach fix, or
- the start of radar vectors to the final approach course, or
- the start of a visual approach

Pilot Flying	Pilot Monitoring
	Set the passenger signs as needed.
	At or above 10,000 feet MSL, set the LEFT and RIGHT WING LANDING light switches to ON.
At transition level, set and crosscheck the altimeters.	
Update the arrival and approach, as needed. Update the RNP as needed.	
Update the approach briefing as needed.	
Call "APPROACH CHECKLIST."	Do the APPROACH checklist.

## Flap Extension Schedule

Current Flap Position	At "Display" or Speed (knots)	Select Flaps	Command Speed for Selected Flaps
UP	"Ref Bug" VREF30 + 80	1	VREF30 + 60
1	VREF30 + 60	5	"Ref Bug" VREF30 + 40
5	"Ref Bug" VREF30 + 40	20	VREF30 + 20
20	VREF30 + 20	25 or 30	(VREF25 or VREF30) + wind additives

## Landing Procedure - ILS

Pilot Flying	Pilot Monitoring
	[Passenger airplanes] Notify the cabin crew to prepare for landing. Verify that the cabin is secure.
Call "FLAPS ___" according to the flap extension schedule.	Set the flap lever as directed.
When on localizer intercept heading: <ul style="list-style-type: none"> <li>• verify that the ILS is tuned and identified</li> <li>• verify that the LOC and G/S pointers are shown</li> </ul>	
Arm the APP mode. Engage the other autopilots.	
Use HDG SEL or HDG HOLD to intercept the final approach course, as needed.	
Verify that the localizer is captured.	
	Call "GLIDE SLOPE ALIVE."
At glide slope alive, call: <ul style="list-style-type: none"> <li>• "GEAR DOWN"</li> <li>• "FLAPS 20"</li> </ul>	Set the landing gear lever to DN. Set the flap lever to 20.
Set the SPEEDBRAKE lever to ARMED.	
At glide slope capture, call "FLAPS ___" as needed for landing.	Set the flap lever as directed.
Set the missed approach altitude on the MCP.	
Call "LANDING CHECKLIST."	Do the LANDING checklist.
At the final approach fix or OM, verify the crossing altitude.	
Monitor the approach. Verify the autoland status at 500 feet radio altitude.	

## Landing Procedure - Instrument Approach Using VNAV

Use the autopilot during the approach to give:

- autopilot alerts and mode fail indications
- more accurate course and glide path tracking
- lower RNP limits.

This procedure is not authorized using QFE.

Pilot Flying	Pilot Monitoring
	<p>[Passenger airplanes] Notify the cabin crew to prepare for landing. Verify that the cabin is secure.</p>
<p>Call "FLAPS __" according to the flap extension schedule.</p>	<p>Set the flap lever as directed.</p>
<p>The recommended roll modes for the final approach are:</p> <ul style="list-style-type: none"> <li>• for a RNAV or GPS approach use LNAV</li> <li>• for a LOC-BC approach use LNAV or B/CRS</li> <li>• for a VOR or NDB approach use LNAV</li> <li>• for a LOC, SDF, or LDA approach use LNAV or LOC</li> </ul>	
	<p>Verify that the VNAV glide path angle is shown on the final approach segment of the LEGS page.</p>
<p>When on the final approach course intercept heading for LOC, LOC-BC, SDF, or LDA approaches:</p> <ul style="list-style-type: none"> <li>• verify that the localizer is tuned and identified</li> <li>• verify that the LOC pointer is shown</li> </ul>	
<p>Arm the LNAV or LOC mode.</p>	
<p><b>WARNING: When using LNAV to intercept the localizer, LNAV might parallel the localizer without capturing it. The airplane can then descend on the VNAV path with the localizer not captured.</b></p>	
<p>Use LNAV, HDG SEL or HDG HOLD to intercept the final approach course as needed.</p>	
<p>Verify that LNAV is engaged or that the localizer is captured.</p>	



Pilot Flying	Pilot Monitoring
<p>Approximately 2 NM before the final approach fix and after ALT HOLD or VNAV PTH is annunciated:</p> <ul style="list-style-type: none"> <li>• verify that the autopilot is engaged</li> <li>• set DA(H) or MDA(H) on the MCP</li> <li>• select or verify VNAV</li> <li>• select or verify speed intervention</li> </ul>	<p>Call "APPROACHING GLIDE PATH."</p>
<p>Approaching glide path, call: "GEAR DOWN" "FLAPS 20"</p>	<p>Set the landing gear lever to DN. Set the flap lever to 20</p>
<p>Set the SPEEDBRAKE lever to ARMED.</p>	
<p>Beginning the final approach descent, call "FLAPS __" as needed for landing.</p>	<p>Set the flap lever as directed.</p>
<p>Call "LANDING CHECKLIST."</p>	<p>Do the LANDING checklist.</p>
<p>When at least 300 feet below the missed approach altitude, set the missed approach altitude on the MCP.</p>	
<p>At the final approach fix, verify the crossing altitude and crosscheck the altimeters.</p>	
<p>Monitor the approach.</p>	
<p>If suitable visual reference is established at MDA(H), DA(H), or the missed approach point, disengage the autopilot and disconnect the autothrottle. Maintain the glide path to landing.</p>	

## Go-Around and Missed Approach Procedure

Pilot Flying	Pilot Monitoring
At the same time: <ul style="list-style-type: none"> <li>• push the GA switch</li> <li>• call "FLAPS 20"</li> </ul>	Position the flap lever to 20.
Verify: <ul style="list-style-type: none"> <li>• the rotation to go-around attitude</li> <li>• that the thrust increases</li> </ul>	
	Verify that the thrust is sufficient for the go-around or adjust as needed.
Verify a positive rate of climb on the altimeter and call "GEAR UP."	Verify a positive rate of climb on the altimeter and call "POSITIVE RATE." Set the landing gear lever to UP.
Above 400 feet radio altitude, select a roll mode.	Verify that the missed approach altitude is set.
Verify that the missed approach route is tracked.	
At acceleration height, set speed to the maneuver speed for the planned flap setting. Call "CLIMB THRUST."	Select CLB thrust.
Call "FLAPS___" according to the flap retraction schedule.	Set the flap lever as directed.
After flap retraction to the planned flap setting, select FLCH or VNAV as needed.	
Verify that climb thrust is set.	
Verify that the missed approach altitude is captured.	
	Set the landing gear lever to OFF after landing gear retraction is complete.
Call "AFTER TAKEOFF CHECKLIST."	Do the AFTER TAKEOFF checklist.

---

---

**Landing Roll Procedure**

<b>Pilot Flying</b>	<b>Pilot Monitoring</b>
Verify that the thrust levers are closed. Verify that the SPEEDBRAKE lever is UP.	Verify that the SPEEDBRAKE lever is UP. Call "SPEEDBRAKES UP." If the SPEEDBRAKE lever is not UP, call "SPEEDBRAKES NOT UP."
Monitor the rollout progress.	
Verify correct autobrake operation.	
<b>WARNING: After the reverse thrust levers are moved, a full stop landing must be made. If an engine stays in reverse, safe flight is not possible.</b>	
Without delay, move the reverse thrust levers to the interlocks and hold light pressure until the interlocks release. Then apply reverse thrust as needed.	
By 60 knots, start movement of the reverse thrust levers to be at the reverse idle detent before taxi speed.	Call "60 KNOTS."
After the engines are at reverse idle, move the reverse thrust levers full down.	
Before taxi speed, disarm the autobrake. Use manual braking as needed.	
Before turing off the runway, disconnect the autopilot.	

---

---

## After Landing Procedure

Start the After Landing Procedure when clear of the active runway.

[Option - PWengines]

Engine cooldown **requirement:**

- Run the engines for at least 90 seconds
- Use a thrust setting no higher than that normally used for all engine taxi operations.

[Option - PWengines]

Engine cooldown recommendations:

- Run the engines for at least 3 minutes
- Use a thrust setting no higher than that normally used for all engine taxi operations.

[Option - RR engines]

Engine cooldown recommendations:

- Run the engines for at least 1 minute
- Use a thrust setting no higher than that normally used for all engine taxi operations.

Pilot Flying	Pilot Monitoring
The captain moves or verifies that the SPEEDBRAKE lever is DOWN.	
	Set the APU selector to START, then ON, as needed.  Do not allow the APU selector to spring back to the ON position.
	Set the exterior lights as needed.
Set the weather radar to off.	
	Set the AUTO BRAKES selector to OFF.
	Set the flap lever to UP.
	Set the transponder mode selector as needed. At airports where ground tracking is not available, select STANDBY. At airports equipped to track airplanes on the ground, select an active transponder setting, but not a TCAS mode.

---

---

## Shutdown Procedure

Start the Shutdown Procedure after taxi is complete.

Parking brake ..... Set C or F/O

Verify that the PARK BRAKE light is illuminated.

Electrical power ..... Set F/O

If APU power is needed:

Verify that the APU RUN light is illuminated.

If external power is needed:

Verify that the EXTERNAL POWER AVAIL light is illuminated.

EXTERNAL POWER switch – Push

Verify that the ON light is illuminated.

WING ANTI-ICE switch ..... Off F/O

ENGINE ANTI-ICE switches ..... Off F/O

FUEL CONTROL switches ..... CUTOFF C

If towing is needed:

Establish communications with ground handling personnel C

**WARNING: If the nose gear steering is not locked out, any change to hydraulic power with the tow bar connected can cause unwanted tow bar movement.**

Verify that the nose gear steering is locked out C

**CAUTION: Do not hold or turn the nose wheel tiller during pushback or towing. This can damage the nose gear or the tow bar.**

**CAUTION: Do not use airplane brakes to stop the airplane during pushback or towing. This can damage the nose gear or the tow bar.**

Set or release the parking brake as directed by ground handling personnel C or F/O

---

SEATBELTS selector .....	OFF	F/O
HYDRAULIC panel.....	Set	F/O

**Note:** Depressurize the right system last to prevent fluid transfer between systems.

Left ELECTRIC pump switch – Off

Center 1 and Center 2 ELECTRIC pump switches – Off

Right ELECTRIC pump switch – Off

FUEL PUMP switches .....	Off	F/O
RED ANTI-COLLISION light switch .....	Off	F/O
ISOLATION switch .....	On	F/O
FLIGHT DIRECTOR switches .....	OFF	C, F/O
Status messages .....	Check	F/O

Record shown status messages in maintenance log.

TCAS mode selector .....	STANDBY	F/O
--------------------------	---------	-----

After wheel chocks are in place:

Parking brake – Release C or F/O

APU selector .....	As needed	F/O
--------------------	-----------	-----

**(SB Deletes BC001, BC002 when Enhanced Flight Deck Security door is installed.)**

Flight deck door .....	Unlock	F/O
------------------------	--------	-----

Verify that the flight deck door UNLKD lights are illuminated.

Call "SHUTDOWN CHECKLIST." C

Do the SHUTDOWN checklist. F/O

---

---

**Secure Procedure**

IRS mode selectors .....	OFF	F/O
EMERGENCY LIGHTS switch .....	OFF	F/O
WINDOW HEAT switches .....	Off	F/O
PACK CONTROL selectors .....	OFF	F/O
Call "SECURE CHECKLIST."		C
Do the SECURE checklist.		F/O

Intentionally  
Blank



# DO NOT USE FOR FLIGHT

757 Flight Crew Operations Manual

## Supplementary Procedures

## Chapter SP

### Table of Contents

### Section 0

<b>Introduction</b> .....	<b>SP.05</b>
General .....	SP.05.1
<b>Airplane General, Emer. Equip., Doors, Windows</b> .....	<b>SP.1</b>
Doors .....	SP.1.1
Entry Door Closing .....	SP.1.1
Entry Door Opening .....	SP.1.1
Flight Deck Door Access System Test .....	SP.1.2
Windows .....	SP.1.2
Flight Deck Window Closing .....	SP.1.2
Flight Deck Window Opening .....	SP.1.2
Lights .....	SP.1.3
Indicator lights test .....	SP.1.3
Emergency Equipment .....	SP.1.3
Oxygen Mask Microphone Test .....	SP.1.3
<b>Air Systems</b> .....	<b>SP.2</b>
Air Conditioning Packs .....	SP.2.1
Ground Conditioned Air Use .....	SP.2.1
Packs Off Takeoff .....	SP.2.1
APU To Pack Takeoff .....	SP.2.2
<b>Anti-Ice, Rain</b> .....	<b>SP.3</b>
Ice Protection .....	SP.3.1
Anti-Ice Use .....	SP.3.1
Windshield Wiper Use .....	SP.3.1
<b>Automatic Flight</b> .....	<b>SP.4</b>
AFDS .....	SP.4.1
AFDS Operation .....	SP.4.1
Heading Hold .....	SP.4.1
Heading Select .....	SP.4.2
Altitude Hold .....	SP.4.2
Flight Level Change, Climb or Descent .....	SP.4.2
Vertical Speed, Climb or Descent .....	SP.4.3
Intermediate Level Off .....	SP.4.4

---

Speed Intervention .....	SP.4.4
Autothrottle Operation .....	SP.4.5
Instrument Approach Using (V/S) .....	SP.4.6
Circling Approach .....	SP.4.7
Autoland Status Annunciator Test .....	SP.4.8
Autoland Status Annunciator Reset .....	SP.4.8
<b>Communications .....</b>	<b>SP.5</b>
Cockpit Voice Recorder Test .....	SP.5.1
Aircraft Communications Addressing and Reporting System (ACARS) .....	SP.5.2
<b>Electrical .....</b>	<b>SP.6</b>
Electrical Power Up .....	SP.6.1
Electrical Power Down .....	SP.6.2
Operation With Less Than 90 KVA External Power Source . . . .	SP.6.2
Before Start Procedure .....	SP.6.2
Before Taxi Procedure .....	SP.6.3
Shutdown Procedure .....	SP.6.3
Standby Power Test .....	SP.6.4
Transfer From External Power To APU Power .....	SP.6.4
Hydraulic Generator Test .....	SP.6.5
<b>Engines, APU .....</b>	<b>SP.7</b>
Engines .....	SP.7.1
Engine Crossbleed Start .....	SP.7.1
Engine Ground Pneumatic Start .....	SP.7.1
Reduced Thrust Selection Prior To Takeoff .....	SP.7.1
Reduced Thrust Selection Prior To Takeoff .....	SP.7.2
Reduced Takeoff Thrust Change or Cancellation .....	SP.7.2
Reduced Takeoff Thrust Change or Cancellation .....	SP.7.3
Reduced Climb Thrust Change or Cancellation .....	SP.7.3
Reduced Climb Thrust Change or Cancellation .....	SP.7.4
Reduced Climb Thrust Selection In-flight .....	SP.7.4
<b>Fire Protection .....</b>	<b>SP.8</b>
Engine, APU and Cargo Fire/Overheat Test .....	SP.8.1

---

Wheel Well Fire Detection Test .....	SP.8.1
<b>Flight Instruments, Displays .....</b>	<b>SP.10</b>
Flight Recorder Test .....	SP.10.1
Heading Reference Switch Operation .....	SP.10.1
QFE Operation .....	SP.10.2
<b>Flight Management, Navigation .....</b>	<b>SP.11</b>
Transponder Test (TCAS equipped airplanes) .....	SP.11.1
Weather Radar Test .....	SP.11.1
IRS .....	SP.11.2
Align Lights Flashing .....	SP.11.2
Fast Realignment .....	SP.11.3
High Latitude Alignment .....	SP.11.3
Position Entry Using IRS Mode Selector Panel .....	SP.11.3
Lateral Navigation .....	SP.11.4
Alternate Route Entry/Activation .....	SP.11.4
Direct To A Waypoint Using Overwrite .....	SP.11.4
Estimate For Alternate .....	SP.11.4
Holding Pattern Entry .....	SP.11.5
Holding Pattern Exit .....	SP.11.5
Intercept A Leg Or Course To A Waypoint Using Overwrite .....	SP.11.6
Lateral Offset .....	SP.11.6
Leg Modification .....	SP.11.7
Route Removal .....	SP.11.7
SID Change Or Runway Change .....	SP.11.8
STAR, Profile Descent Or Approach Change .....	SP.11.8
Vertical Navigation .....	SP.11.9
Climb, Cruise Or Descent Speed Schedule Change .....	SP.11.9
Climb Or Descent Direct To MCP Altitude .....	SP.11.9
Cruise Altitude Change .....	SP.11.9
Speed/Altitude Constraint At Waypoint .....	SP.11.10
Speed/Altitude Transition And Restriction .....	SP.11.10
Temporary Altitude Restriction .....	SP.11.10
Temporary Speed Restriction .....	SP.11.11
Performance Data Entries .....	SP.11.11
Descent Forecast .....	SP.11.11
Step Climb Evaluation .....	SP.11.11

---

Waypoint Winds .....	SP.11.11
Additional CDU Functions .....	SP.11.12
Fix Page Entries .....	SP.11.12
HSI Plan Mode Control .....	SP.11.12
Navaid Inhibit .....	SP.11.12
Update Active Navigation Database .....	SP.11.13
<b>Fuel .....</b>	<b>SP.12</b>
Fuel Balancing .....	SP.12.1
Fuel Quantity Test .....	SP.12.1
<b>Warning Systems .....</b>	<b>SP.15</b>
EICAS Test .....	SP.15.1
Takeoff Configuration Warning Test .....	SP.15.1
Landing Configuration Warning Test .....	SP.15.1
Stall Warning Test .....	SP.15.2
Event Record .....	SP.15.2
<b>Adverse Weather .....</b>	<b>SP.16</b>
Introduction .....	SP.16.1
Takeoff - Wet or Contaminated Runway Conditions .....	SP.16.1
Cold Weather Operations .....	SP.16.2
Exterior Inspection .....	SP.16.2
Engine Start Procedure .....	SP.16.3
Engine Anti-ice Operation - On the Ground .....	SP.16.3
Before Taxi Procedure .....	SP.16.4
Taxi-Out .....	SP.16.4
De-icing / Anti-icing .....	SP.16.5
Before Takeoff Procedure .....	SP.16.5
Takeoff Procedure .....	SP.16.6
Engine Anti-ice Operation - In-flight .....	SP.16.6
Wing Anti-ice Operation - In-flight .....	SP.16.7
Cold Temperature Altitude Corrections .....	SP.16.8
After Landing Procedure .....	SP.16.10
Secure Procedure .....	SP.16.11
Hot Weather Operation .....	SP.16.12
Moderate to Heavy Rain, Hail or Sleet .....	SP.16.12

**757 Flight Crew Operations Manual**

---

Turbulence .....	SP.16.13
Severe Turbulence .....	SP.16.13
Windshear .....	SP.16.14
Avoidance.....	SP.16.14
Precautions .....	SP.16.15

Intentionally  
Blank

**General**

This chapter contains procedures (adverse weather operation, engine crossbleed start, and so on) that are accomplished as required rather than routinely performed on each flight. System tests which the flight crew are likely to perform are also included.

Procedures accomplished in flight, or those that are an alternate means of accomplishing normal procedures (such as selecting reduced T.O. thrust), are usually accomplished by memory. Infrequently used procedures, not normally accomplished (such as engine crossbleed start) are usually accomplished by reference.

Supplementary procedures are provided by section. Section titles correspond to the respective chapter title for the system being addressed except for the Adverse Weather section.

Intentionally  
Blank



**Doors**

**Entry Door Closing**

Gust lock lever ..... Release

Door ..... Close

Manually rotate the door aft and inboard to cover the entry.

Door handle ..... Rotate

Rotate forward to the closed position. The door moves outboard into position, latches, and locks.

Mode select lever ..... ARMED

Observe slide placard in view and SLIDE light illuminated.

**Entry Door Opening**

Mode select lever (interior only) ..... DISARMED

Observe slide placard out of view and SLIDE light extinguished.

**Note:** Escape slide and powered door opening is disarmed automatically when the door is opened from outside.

Door handle ..... Rotate

Rotate aft to the open position. The door moves inboard to the cocked position.

Door ..... Open

Manually rotate the door outboard and forward to open. The gust lock lever automatically engages and locks door in the open position.

---

## Flight Deck Door Access System Test

(SB Adds BC001, BC002 with Enhanced Security Flight Deck Door test.)

- Flight Deck Access System switch ..... Norm
- Flight Deck Door ..... Open
- Flight Deck Door Lock selector ..... AUTO
- Emergency access code ..... Enter
- ENT key ..... Push
- Verify alert sounds.
- Verify AUTO UNLK light illuminates.
- Flight Deck Door Lock selector ..... Deny
- Verify AUTO UNLK light extinguishes.
- Flight Deck Door Lock selector ..... ULNLK
- Flight Deck Access System switch ..... OFF
- Verify LOCK FAIL light illuminates.
- Flight Deck Access System switch ..... NORM (guard down)
- Verify LOCK FAIL light extinguishes.

---

## Windows

### Flight Deck Window Closing

- Window crank ..... Rotate
- Crank the window to the full closed position (the WINDOW NOT CLOSED placard not visible).
- Window lock lever ..... Rotate
- Rotate the window lock lever forward to the locked position.

### Flight Deck Window Opening

- Window lock lever ..... Rotate
- Rotate the window lock lever aft to the open position.
- Window crank ..... Rotate
- Crank the window to the full open position (the WINDOW NOT CLOSED placard is visible).

---

---

## Lights

### Indicator lights test

- INDICATOR LIGHTS TEST switch ..... Push ON  
Verify all indicator lights in the flight deck, except lights in the fuel control and APU/engine fire switches illuminated.
- INDICATOR LIGHTS TEST switch ..... Push OFF

---

---

## Emergency Equipment

### Oxygen Mask Microphone Test

- BOOM/OXY switch ..... OXY
- RESET/TEST switch ..... Push and hold
- EMERGENCY/TEST selector ..... Push and hold
- Push-To-Talk (PTT) switch ..... Push  
Simultaneously push the push to talk switch, emergency/test selector, and reset/test switch.  
Verify oxygen flow sound is heard through the flight deck loudspeaker.
- PTT switch ..... Release
- EMERGENCY/TEST selector ..... Release
- RESET/TEST switch ..... Release

Intentionally  
Blank

**Air Conditioning Packs**

**Ground Conditioned Air Use**

Before connecting ground conditioned air:

Pack control selectors ..... OFF

Prevents pack operation if bleed air is supplied to the airplane.

After disconnecting ground conditioned air:

Pack control selectors .....AUTO

**Packs Off Takeoff**

Before takeoff:

Pack control selectors (both) ..... OFF

After takeoff:

**Note:** If engine failure occurs, pack control selectors should remain OFF until reaching 1,500 feet or until obstacle clearance height has been attained, whichever is higher.

Pack control selector (one only) .....AUTO

After engine thrust is reduced from takeoff, position one pack selector to AUTO.

Pack control selector (remaining pack) .....AUTO

When cabin pressurization stabilizes, position remaining pack selector to AUTO.

---

## APU To Pack Takeoff

This procedure is used to make a takeoff using no bleed air from the engines. Air for left pack operation is supplied from the APU.

**CAUTION: This procedure is not allowed if icing conditions exist for taxi or takeoff.**

After engine start:

APU selector ..... START or ON

Start APU or leave APU running.

Before takeoff:

Engine bleed air switches ..... OFF

After takeoff:

**Note:** If engine failure occurs, engine bleed air switches should remain OFF until reaching 1,500 feet or until obstacle clearance height has been attained, whichever is higher.

Right engine bleed air switch ..... On

After engine thrust is reduced from takeoff, position right engine bleed air switch on.

Left engine bleed air switch ..... On

After cabin rate of climb stabilizes, position left engine bleed air switch on.

APU selector ..... OFF

---

**Ice Protection**

Ice protection is provided by the airplane anti-ice systems.

---

**Anti-Ice Use**

Requirements for use of anti-ice and operational procedures for engine and wing anti-ice are moved from SP.3 to Supplementary Procedures, Adverse Weather Section SP.16.

---

**Windshield Wiper Use**

**CAUTION: Do not use windshield wipers on a dry window.**

Windshield Wiper selector (as required) ..... LOW/HIGH

Intentionally  
Blank



**AFDS**

**AFDS Operation**

If Flight Director (F/D) operation is desired:

FLIGHT DIRECTOR switches ..... ON

On ground, observe flight director command wings level and 8° pitch up and ADI flight mode displays TO, TO, FD.

In-flight, observe flight director command and ADI display vertical speed (V/S) and heading hold (HDG HOLD) or attitude (ATT) if no autopilot in command (CMD), or display existing autopilot modes if any autopilot in command (CMD).

**Note:** Command bars are not displayed if selected autopilot command mode and flight director source are the same.

AFDS Mode(s) ..... Engage as desired

Observe flight director command and selected AFDS mode(s) is displayed.

If the autopilot is desired:

Command switch ..... Engage

Observe flight mode annunciations display V/S and HDG HOLD or ATT, or existing AFDS modes if flight director on and not in takeoff or go-around mode.

Observe flight mode annunciations display V/S and HDG HOLD; or existing AFDS modes if flight director on and not in takeoff or go-around mode.

**Heading Hold**

Rolls wings level and maintains the heading that exists at the time the wings become level.

Heading Hold switch ..... Engage

Observe HDG HOLD displayed on ADI.

## Heading Select

Heading selector ..... Set as desired

Heading selector switch ..... Push

Observe HDG SEL is displayed on ADI.

Bank Limit selector ..... Set as desired

## Altitude Hold

Altitude Hold switch ..... Engage

Verify ALT HOLD is displayed on ADI.

## Flight Level Change, Climb or Descent

Altitude selector ..... Set

Set level off altitude in the altitude window.

Flight Level Change switch ..... Engage

Observe FLCH and SPD displayed on ADI.

IAS/MACH selector ..... Set

Set the desired speed in the speed window.

Climb Thrust Reference Mode Select switch (if required) ..... Select

If climb initiated, select climb reference EPR.

**Vertical Speed, Climb or Descent**

Altitude selector .....Set

Set level off altitude in the altitude window.

Vertical Speed switch .....Engage

Observe V/S displayed on ADI.

**Note:** The vertical speed mode does not provide automatic low speed protection and permits flight away from selected altitude. For level-off protection, always select new level-off altitude prior to engaging vertical speed mode.

Vertical Speed selector .....Set

Set desired rate in vertical speed window.

Climb Thrust Reference Mode Select switch (if required) ..... Select

If climb initiated, select climb reference EPR.

## Intermediate Level Off

Altitude selector ..... Rotate  
Set desired altitude in altitude window.

At MCP altitude:

Verify pitch mode annunciation is ALT HOLD.

To resume climb/descent:

Altitude selector ..... Rotate  
Set desired altitude in altitude window.

If using VNAV:

VNAV switch ..... Engage  
Verify pitch mode annunciation is VNAV SPD or VNAV  
PTH as appropriate.

If using Flight Level Change:

Flight Level Change switch ..... Engage  
Verify pitch mode annunciation is SPD and autothrottle  
annunciation is FLCH.

IAS/MACH selector ..... Rotate  
Set desired speed in IAS/MACH window.

## Speed Intervention

IAS/MACH selector ..... Push  
Verify IAS/MACH window opens.

IAS/MACH selector ..... Rotate  
Set the desired speed in the IAS/MACH window.

To resume FMC speed schedule:

IAS/MACH selector ..... Push  
Verify IAS/MACH window blanks.

## Autothrottle Operation

Autothrottle switch ..... A/T ARM

If EPR mode desired:

Thrust Reference Mode Select switch (as desired) ..... Select  
Select desired reference EPR.

EPR switch ..... Engage  
Observe EPR display on ADI.

If Speed mode desired:

Thrust Reference Mode Select switch (as desired) ..... Select  
Select desired reference EPR.

Speed switch ..... Engage  
Observe SPD display on ADI.

IAS/MACH selector ..... Set  
Set the desired speed in the IAS/MACH window.

---

---

## Instrument Approach Using (V/S)

**Note:** Autopilot use is recommended until suitable visual reference is established.

**Note:** If required to remain at or above the MDA(H) during the missed approach, missed approach must be initiated at least 50 feet above MDA(H).

Recommended roll modes for final approach:

- RNAV, GPS, LOC-BC, VOR or NDB approach: LNAV or HDG SEL (B/CRS for LOC-BC approaches)
- LOC, SDF, or LDA approach: LOC or LNAV

Ensure appropriate nav aids (VOR, LOC or NDB) are tuned and identified prior to commencing the approach.

RNP appropriate for approach (if required) ..... Verify/Enter  
Allows appropriate alerting to occur if ANP exceeds RNP.

Before descent to MDA(H):

MCP altitude selector ..... Set  
Set the first intermediate altitude constraint or MDA(H). When the current constraint is assured, the next constraint may be set prior to ALT HOLD engaged to achieve continuous descent path.

If constraints or MDA(H) do not end in zero zero (00; for example, 1820), set MCP ALTITUDE window to the closest 100 foot increment below the constraint or MDA(H).

At descent point:

V/S switch ..... Push  
Verify V/S Mode annunciates.

Desired V/S ..... Set  
Set desired V/S to descend to MDA(H). Use a V/S that results in no level flight segment at MDA(H).

Approximately 300 feet above MDA(H):

MCP altitude selector ..... Set Missed Approach Altitude

At MDA(H)/Missed Approach Point:

If suitable visual reference is not established, execute missed approach.

After suitable visual reference is established:

A/P Disengage Switch ..... Push

Disengage autopilot before descending below  
MDA(H)/DA(H)

A/T Disconnect Switch ..... Push

Disconnect autothrottle before descending below  
MDA(H)/DA(H)

**Circling Approach**

**Note:** Autopilot use is recommended until intercepting the landing profile.

MCP Altitude Selector ..... Set

If the MDA(H) does not end in zero zero (00; for example, 1820), set MCP ALTITUDE window to the closest 100 foot increment below the MDA(H)

Accomplish an instrument approach and establish suitable visual reference.

At MDA(H):

ALT HOLD switch (if required) ..... Push

Enables level off at MDA(H). Verify ALT HOLD mode annunciates.

MCP altitude selector ..... Set Missed Approach Altitude

HDG SEL Switch ..... Push

Verify HDG SEL mode annunciates.

Intercepting the landing profile:

Autopilot disengage switch ..... Push

Autothrottle disconnect switch ..... Push

**Autoland Status Annunciator Test**

AUTOLAND STATUS ANNUNCIATOR TEST switch 1 ..... Push  
Observe LAND 3 and NO LAND 3 in view.

AUTOLAND STATUS ANNUNCIATOR TEST switch 2 ..... Push  
Observe LAND 2 and NO AUTOLAND in view.

---

**Autoland Status Annunciator Reset**

AUTOLAND STATUS ANNUNCIATOR  
PUSH/RESET switch ..... Push



---

**Cockpit Voice Recorder Test**

Voice Recorder Test switch.....Push

Push and observe monitor indicator needle to be in the green band.  
A tone may be heard with headset plugged into headset jack. Test  
will last approximately 5 seconds.

## **Aircraft Communications Addressing and Reporting System (ACARS)**

The following procedures are one means which may be used to verify Pre-departure Clearance, Digital-Automatic Terminal Information Service, Oceanic Clearances, Weight and Balance and Takeoff Data messages transmitted over ACARS.

### **Pre-Departure Clearance**

The flight crew shall manually verify (compare) the filed flight plan versus the digital pre-departure clearance and shall initiate voice contact with Air Traffic Control if any question/confusion exists between the filed flight plan and the digital pre-departure clearance.

### **Digital-Automatic Terminal Information Service**

The flight crew shall verify that the D-ATIS altimeter setting numeric value and alpha value are identical. If the D-ATIS altimeter setting numeric and alpha values are different, the flight crew must not accept the D-ATIS altimeter setting.

### **Oceanic Clearances**

The flight crew shall manually verify (compare) the filed flight plan versus the digital oceanic clearance and initiate voice contact with Air Traffic Control if any question/confusion exists between the filed flight plan and the digital oceanic clearance.

### **Weight and Balance**

The flight crew shall verify the Weight and Balance numerical and alphabetical values are identical. If the Weight and Balance numeric and alphabetical values are different, the flight crew must not accept the Weight and Balance data.

### **Takeoff Data**

The flight crew shall verify the Takeoff Data numerical and alphabetical values are identical. If the Takeoff Data numeric and alphabetical values are different, the flight crew must not accept the Takeoff Data message.

**Electrical Power Up**

The following procedure is accomplished to permit safe application of electrical power.

Battery switch ..... ON

Standby Power selector ..... AUTO

Verify battery DISCH light illuminated and standby bus OFF light extinguishes.

Hydraulic Electric Pump switches ..... OFF

Landing Gear Lever ..... DN

Alternate Flaps selector ..... NORM

Electrical Power ..... Establish

Bus Tie switches ..... AUTO

If external power is desired:

External Power AVAIL light ..... Illuminated

External Power switch ..... Push

If APU power is desired:

APU Generator switch ..... ON

APU selector ..... START, THEN ON

Position the APU selector back to the ON position. Do not allow the APU Selector to spring back to the ON position.

---

---

## Electrical Power Down

The following flight deck procedures are accomplished to permit removal of electrical power from the airplane.

External Power switch ..... OFF

APU selector ..... OFF

When APU RUN light extinguishes:

Standby Power selector ..... OFF

Battery switch ..... OFF

---

---

## Operation With Less Than 90 KVA External Power Source

When external power source is less than required (90 KVA), airplane electrical loads must be minimized by supplementing normal procedures as follows:

### Before Start Procedure

Accomplish normal exterior Inspection, Preflight Procedure – First Officer, Preflight Procedure – Captain and Before Start Procedure through "Start Clearance.....Obtain".

Confirm cargo loading complete.

Utility Bus switches ..... OFF

Hydraulic System ..... Set

Electric Pump switch (right) ..... ON

Observe PRESS light extinguished.

Fuel Pump switches (one left and one right main wing) ..... ON

Observe PRESS lights extinguished.

**Note:** Delay activation of the remaining hydraulic and fuel pumps, setting trim and checking flight controls until after engines are started.

Complete the normal Before Start and Engine Start procedures.

**Before Taxi Procedure**

Hydraulic System .....	Set
Electric Pump switches (remaining pumps) .....	ON
Observe PRESS lights extinguished.	
Utility Bus switches .....	ON
Fuel Pump switches (remaining pumps) .....	ON
Position switches ON for all tanks containing fuel.	
Trim .....	Set
Flight Controls .....	Check

Displace control wheel and control column to full travel in both directions and verify:

- freedom of movement
- controls return to center
- proper flight control movement on EICAS status display.

Hold the nose wheel steering tiller during rudder check to prevent undesired nose wheel movement.

Displace rudder pedals to full travel in both directions and verify:

- freedom of movement
- rudder pedals return to center
- proper flight control movement on EICAS status display.

Complete normal Before Taxi procedure.

**Shutdown Procedure**

After park brake is set and prior to establishing external power:

Hydraulic System .....	Set
Electric Pump switches (all) .....	Off
Fuel Pump switches .....	Off

Accomplish normal Shutdown procedure.

## Standby Power Test

Airplane must be on ground with all busses powered.

Standby Power Selector .....BAT

Observe battery DISCH light illuminates and standby power  
OFF light remains extinguished.

Standby Power Selector .....AUTO

Observe battery DISCH light extinguishes and standby power  
OFF light remains extinguished.

---

## Transfer From External Power To APU Power

Prior to disconnecting external power:

External Power switch ..... Push

Observe ON light extinguish.

## Hydraulic Generator Test

Electrical power must be established on the airplane.

- L and R Hydraulic Electric Pump Switches ..... ON
- EICAS Status Display ..... On
- PTU Switch ..... ON
- Hydraulic Generator Test Switch ..... HYD GEN

While holding the test switch in the HYD GEN position, verify the HYD GEN ON and HYD GEN VAL Status messages appear on EICAS, and Captain ADI and HSI are powered with no flags displayed. The HYD GEN ON and HYD GEN VAL messages should no longer be displayed when the test switch is released\*.

\*On airplanes with 10 KVA Hydraulic Driven Generator, the generator will continue to operate for approximately 15 seconds after the test switch is released.

**CAUTION: If the Hydraulic Generator Test switch is held in the HYD GEN position for longer than 10 seconds with the Left Hydraulic system turned OFF (Left Electric Pump OFF and engine shutdown), the Hydraulic Driven Generator will be "latched out" with no indications that it is now unusable. Completely removing electrical power from the airplane (with battery off) ensures that the Hydraulic Driven Generator Control Unit is reset following the test.**

**Note:** For a full functional check see the Maintenance Manual (24-25-00) or Dispatch Deviation Guide (24-00-01).

Intentionally  
Blank



**Engines**

**Engine Crossbleed Start**

The APU must be shut down or the APU bleed air switch must be OFF

Check that the area behind the airplane is clear

Engine Bleed Air switch (operating engine) ..... ON

**Option: Rolls Royce Engines**

Advance thrust on operating engine to approximately 65% N3 and accomplish normal Engine Start procedure

**Option: Pratt and Whitney Engines**

Advance thrust on operating engine to approximately 70% N2 and accomplish normal Engine Start procedure

**Engine Ground Pneumatic Start**

Check duct pressure 30 psi or greater

Start engine using normal Engine Start procedure

**Reduced Thrust Selection Prior To Takeoff**

If reduced takeoff thrust desired:

Assumed Temperature ..... Set

Rotate assumed temperature selector clockwise and set desired temperature value or enter temperature on Takeoff Reference page

Observe D–TO displayed in green on the EICAS

If reduced climb thrust desired:

Thrust Reference Mode Select switch ..... 1 or 2

Select desired climb thrust reference; 1 or 2

Observe TO 1 or TO 2 (D-TO 1 or D-TO 2 for an assumed temperature derated takeoff) displayed on the EICAS in green for the TO or D-TO and in white for the numerals 1 or 2

---

## Reduced Thrust Selection Prior To Takeoff

If both reduced takeoff and climb thrust desired:

- Thrust Reference Mode Select switch ..... 1 or 2
- Select desired climb thrust reference; 1 or 2
- CLB 1 or CLB 2 is preselected
- Observe TO 1 or TO 2 displayed in green on the EICAS

If additional takeoff thrust reduction desired:

- Assumed Temperature ..... Set
- Rotate assumed temperature selector clockwise and set desired temperature value or enter temperature on Takeoff Reference page
- CLB 1 or CLB 2 is preselected
- Observe D-TO 1 or D-TO 2 displayed in green on the EICAS

If only reduced takeoff thrust desired:

- Assumed Temperature ..... Set
- Rotate assumed temperature selector clockwise and set desired temperature value or enter temperature on Takeoff Reference page
- Observe D-TO displayed in green on the EICAS

## Reduced Takeoff Thrust Change or Cancellation

If change desired:

- Accomplish “Reduced Thrust Selection Prior To Takeoff” procedural steps

If cancellation desired:

- Thrust Reference Mode Select switch ..... As desired
- Select desired thrust reference mode; TO/GA, CLB, CON or CRZ
- Observe associated mode displayed

**Note:** If full takeoff thrust desired during takeoff following 80 knots (autothrottle in THR HOLD mode) thrust levers must be adjusted manually.

---

## Reduced Takeoff Thrust Change or Cancellation

If change desired:

Assumed Temperature .....Set  
Rotate assumed temperature selector and set new temperature value or enter required temperature on Takeoff Reference page

If cancellation desired:

Thrust Reference Mode Select switch .....As desired  
Select desired thrust reference mode; TO/GA, CLB, CON or CRZ  
Observe associated mode displayed

**Note:** If full takeoff thrust desired during takeoff following 80 knots (autothrottle in THR HOLD mode) thrust levers must be adjusted manually.

## Reduced Climb Thrust Change or Cancellation

If change desired:

Thrust Reference Mode Select switch ..... 1 or 2  
Select desired climb thrust reference; 1 or 2  
Observe CLB 1 or CLB 2 (TO 1 or TO 2; ground only) displayed

If cancellation desired:

Thrust Reference Mode Select switch ..... 1 or 2  
Push switch associated with current thrust reduction  
Observe CLB or TO (ground only) displayed

**Note:** If preselected reduced climb thrust is changed or cancelled and reduced takeoff thrust is still desired, reduced takeoff thrust must be reselected.

## **Reduced Climb Thrust Change or Cancellation**

If change desired:

- Thrust Reference Mode Select switch ..... 1 or 2
- Select desired climb thrust reference; 1 or 2
- Observe CLB 1 or CLB 2 (TO 1 or TO 2; ground only) displayed

If cancellation desired:

- Thrust Reference Mode Select switch ..... 1 or 2
- Push switch associated with current thrust reduction
- Observe CLB or TO (ground only) displayed

## **Reduced Climb Thrust Selection In-flight**

- Thrust Reference Mode Select switch ..... CLB
- Observe CLB displayed
  
- Thrust Reference Mode Select switch ..... 1 or 2
- Select desired thrust reference; 1 or 2
- Observe CLB 1 or CLB 2 displayed

---

**Engine, APU and Cargo Fire/Overheat Test**

- Engine/APU/Cargo Fire/Overheat Test switch ..... Push
  - Observe the fire bell ring intermittently
  - Observe the following lights illuminate:
    - Discrete FIRE warning
    - Fuel control switches
    - L and R ENG OVHT
    - LEFT, RIGHT and APU fire switches
    - FWD and AFT cargo fire
    - Master Warning
  - Observe the following EICAS messages:
    - APU FIRE warning
    - FWD and AFT CARGO FIRE warning
    - L and R ENGINE FIRE warning
    - L and R ENG OVHT caution

**Option: Rolls Royce Engines**

- Engine Fire/Overheat Test switch ..... Push
  - Observe above indications, except APU and cargo fire warnings

---

**Wheel Well Fire Detection Test**

- Wheel Well Fire Test switch ..... Push
  - Observe the fire bell ring intermittently
  - Observe the following lights illuminate:
    - Discrete FIRE warning
    - WHL WELL FIRE
    - Master Warning
  - Observe the following EICAS message:
    - WHEEL WELL FIRE warning

Intentionally  
Blank

---

**Flight Recorder Test**

Flight Recorder switch ..... TEST  
Observe OFF light extinguish.

---

**Heading Reference Switch Operation**

Use TRUE when flying in regions where true referencing is required. Use NORM at other times.

Heading Reference switch ..... NORM or TRUE

**Note:** The following information applies when using the Heading Reference switch:

- If the AFDS is in the HDG SEL mode and the Heading Reference switch position is changed, the AFDS mode changes to HDG HOLD; HDG SEL may be reselected.
- If making an ILS approach using true referencing, the localizer course referenced to true north must be set on the ILS control panel.
- VOR bearings are not available when the Heading Reference switch is in TRUE.

---

---

## QFE Operation

Use this procedure when ATC altitude assignments are referenced to QFE altimeter settings, and QNH settings are not available.

**Note:** Do not use LNAV or VNAV below transition altitude/level.  
Altitudes in the navigation data base are not referenced to QFE.  
Use only raw data for navigation.

Altimeters ..... Set  
Set primary and standby altimeters to QFE below transition altitude/level.

**Note:** If the QFE altimeter setting is beyond the range of the altimeters, QNH procedures must be used with QNH set in the altimeters.

Landing Altitude Indicator ..... Set at Zero

Terrain Override switch ..... OVRD



**Transponder Test (TCAS equipped airplanes)**

This procedure requires the IRSs to be aligned and in NAV mode.

Transponder Mode selector ..... TEST  
Verify "TCAS SYSTEM TEST OK" aural sounds.

**Weather Radar Test**

Weather Radar Mode ..... TEST  
HSI Mode selector ..... MAP  
Weather Radar switch ..... ON  
Observe radar test pattern on HSI.

**Note:** If the airplane is on the ground and the thrust levers are not advanced for takeoff, the WXR tests the predictive windshear system (PWS) indications. These include the WINDSHEAR SYS EICAS advisory, the PWS caution, and PWS warning. Deactivating WXR on the EFIS control panel will not discontinue the test and can result in automatic WXR activation on both pilot displays. The PWS test lasts approximately 15 seconds.

**Note:** If the airplane is on the ground and the thrust levers are not advanced for takeoff, the WXR tests the predictive windshear system (PWS) indications. These include the WINDSHEAR SYS EICAS advisory, the PWS caution, and PWS warning. Deactivating WXR on the EFIS control panel will discontinue the test. The PWS test lasts approximately 15 seconds.

Weather Radar switch ..... OFF  
Select captain's and first officer's weather radar displays off.  
Weather Radar Mode ..... As desired

---

---

## IRS

### Align Lights Flashing

Do not move IRS Mode selector to OFF except where called for in procedure.

POS INIT page ..... Select

Set IRS Position ..... Enter Present Position

Enter present position using most accurate latitude and longitude available. If a position is already displayed on the SET IRS POS line, enter new position over displayed position.

If ALIGN light continues to flash:

Set IRS Position ..... Enter Present Position

Re-enter same present position.

If ALIGN light continues to flash after re-entry:

IRS ..... OFF

Rotate IRS Mode selector to OFF and verify ALIGN light extinguished.

**Note:** Light must be extinguished before continuing with procedure (approximately 30 seconds).

IRS ..... NAV

Rotate IRS Mode selector to NAV and verify ALIGN light illuminated.

Set IRS Position ..... Enter

Enter present position in boxes. If ALIGN light flashes, re-enter same present position over displayed position.

**Note:** Approximately ten minutes is required for realignment.

If ALIGN light continues to flash, maintenance action is required.

## Fast Realignment

If the combined operating time from the last full IRS alignment to the expected next destination arrival time does not exceed 18 hours, a fast realignment may be accomplished.

IRS Mode selectors ..... ALIGN

CDU ..... Set

Enter present position on SET IRS POSITION line of Position Initialization page.

IRS Mode selectors ..... NAV

## High Latitude Alignment

This procedure applies to alignment at latitudes greater than 70°12.0' and less than 78°15.0'.

IRS Mode selectors ..... OFF, then ALIGN

POS INIT page ..... Set

Enter present position on SET IRS POS line using the most accurate latitude and longitude available.

IRS Mode selectors ..... NAV

Select NAV after remaining in ALIGN for 17 minutes minimum.  
Verify ALIGN lights extinguished.

## Position Entry Using IRS Mode Selector Panel

Latitude ..... Enter

Begin with N or S, followed by latitude including trailing zeros, i.e., N003°30.0' entered as N3300.

Longitude ..... Enter

Begin with E or W, followed by longitude including trailing zeros, i.e., E001°11.0' entered as E1110.

---

---

## Lateral Navigation

### Alternate Route Entry/Activation

Desired RTE page 1 ..... Select

If desired route (1 or 2) not displayed, select desired route.

Route (if required) ..... Enter

Enter route using preflight procedure.

ACTIVATE ..... Select

If in-flight, use DIRECT TO or INTC LEG TO boxes to enter desired course from present position to new route.

EXEC key ..... Push

### Direct To A Waypoint Using Overwrite

RTE LEGS page ..... Select

Desired Waypoint ..... Enter

Enter the desired waypoint over the active waypoint.

Waypoint Sequence ..... Check

Enter waypoints in desired sequence.

EXEC key ..... Push

### Estimate For Alternate

PROGRESS page 1 ..... Select

Desired Destination ..... Enter

**Note:** Estimates displayed are for present position direct.

## Holding Pattern Entry

Holding fix must be a route waypoint or present position before accomplishing following steps.

HOLD key ..... Push

NEXT HOLD (if displayed) ..... Select

Holding Fix ..... Enter

To hold at present position, select PPOS. To hold at waypoint, enter waypoint identifier in HOLD AT boxes.

HOLD page ..... Check

EXEC key ..... Push

## Holding Pattern Exit

To exit holding accomplish the following procedure or refer to one of the “Direct to a Waypoint” procedures.

EXIT HOLD ..... Select

EXEC key ..... Push

---

## Intercept A Leg Or Course To A Waypoint Using Overwrite

RTE LEGS page ..... Select

Desired Waypoint ..... Enter

Enter the desired waypoint over the active waypoint.

**Note:** If waypoint not previously in route, a discontinuity occurs.

If waypoint was previously in route, the inbound course is set to same inbound great circle course. For airways, displayed course may not be identical to charted value.

If inbound course not correct:

Intercept Course ..... Enter

Enter course desired at waypoint in INTC CRS TO boxes (or over existing intercept course to value if waypoint was already in route).

EXEC key ..... Push

Waypoint Sequence ..... Check

Enter waypoints in desired sequence.

EXEC key ..... Push

If necessary, use Heading Select mode to change intercept heading. Then, arm LNAV mode.

## Lateral Offset

RTE page ..... Select

Offset ..... Enter

Enter desired offset direction and distance over OFFSET dashes.

EXEC key ..... Push

To remove offset, accomplish Direct To procedure or enter “0” in OFFSET line.

## Leg Modification

To modify active waypoint or leg, accomplish one of the Direct To or Intercept A Leg Or Course procedures except when entering along track waypoints.

RTE LEGS page ..... Select

To change waypoint sequence:

Desired Waypoint Sequence ..... Enter

**Note:** If waypoint not previously in route a discontinuity occurs except when entering along track waypoints.

EXEC key ..... Push

To delete a waypoint at end of route:

DEL key ..... Push

Waypoint ..... Select

EXEC key ..... Push

To enter along track waypoints:

Along Track Displacement ..... Enter

Select reference waypoint to scratch pad and modify for desired displacement.

Reference Waypoint ..... Select

The FMC will automatically position the created waypoint to the appropriate position.

EXEC key ..... Push

## Route Removal

RTE page 1 ..... Select

Origin ..... Enter

If EXEC key illuminates:

EXEC key ..... Push

## **SID Change Or Runway Change**

This entire procedure must be accomplished when a SID is used and the runway or SID is changed. This will prevent the possibility of incorrect routing or inadequate obstacle clearance.

- DEPARTURES page ..... Select
- Runway ..... Reselect
- SID ..... Reselect
- Transition (if required) ..... Reselect
- RTE LEGS page ..... Select
- Waypoint Sequence and Altitudes ..... Check  
    Modify as necessary to agree with clearance.
- EXEC key ..... Push

## **STAR, Profile Descent Or Approach Change**

Associated airport must be entered as route origin or destination.

- ARRIVALS page ..... Select
- STAR or Profile Descent (if required) ..... Select
- Transition (if required) ..... Select
- Approach ..... Select
- Approach Transition (if required) ..... Select
- RTE LEGS page ..... Select
- Waypoint Sequence and Altitudes ..... Check  
    Modify as necessary to agree with clearance.
- EXEC key ..... Push



---

---

## Vertical Navigation

### Climb, Cruise Or Descent Speed Schedule Change

CLB or CRZ or DES page ..... Select

To change schedule:

Desired Schedule ..... Select

To enter fixed speed schedule:

Desired Speed ..... Enter

Enter speed on ECON/SEL SPD line (line 2L).

EXEC key ..... Push

### Climb Or Descent Direct To MCP Altitude

This procedure deletes all waypoint altitude constraints between current airplane altitude and altitude set in MCP.

Altitude Window ..... Set

CLB or DES page ..... Select

CLB DIR or DES DIR ..... Select

EXEC key ..... Push

### Cruise Altitude Change

Altitude Window ..... Set

CRZ page ..... Select

Cruise Altitude ..... Enter

EXEC key ..... Push

---

## Speed/Altitude Constraint At Waypoint

RTE LEGS page ..... Select

To enter or modify constraint:

Speed/Altitude ..... Enter

**Note:** Speed entry requires “/” mark and altitude.

EXEC key ..... Push

To delete constraint:

DEL key ..... Push

Speed/Altitude ..... Select

Select undesired constraint and observe estimated values appear.

EXEC key ..... Push

## Speed/Altitude Transition And Restriction

CLB or DES page ..... Select

To enter speed/altitude restriction:

Speed/Altitude ..... Enter

EXEC key ..... Push

To delete speed/altitude restriction or transition:

DEL key ..... Push

Speed/Altitude ..... Select

EXEC key ..... Push

## Temporary Altitude Restriction

Altitude Window ..... Set

To resume climb or descent:

Altitude Window ..... Set

VNAV ..... Engage

## Temporary Speed Restriction

- IAS/MACH selector ..... Push  
Speed Window ..... Set  
To resume FMC speed schedule:  
IAS/MACH selector ..... Push
- 

## Performance Data Entries

### Descent Forecast

- DES page ..... Select  
DESCENT FORECAST page ..... Select  
Transition Level ..... Check  
Thermal Anti-ice On Altitude (if required) ..... Enter  
Wind Altitude ..... Enter  
Enter altitude over dashes on left.  
Wind Direction/Speed ..... Enter

### Step Climb Evaluation

- CRZ page ..... Select  
Step to Altitude ..... Enter  
Savings ..... Check

### Waypoint Winds

- RTE LEGS page ..... Select  
RTE DATA page ..... Select  
WINDS page ..... Select  
Altitude and Wind ..... Enter  
EXEC key ..... Push

---

---

## Additional CDU Functions

### Fix Page Entries

FIX page ..... Select

Fix Identifier ..... Enter

Bearing or Distance From Fix ..... Enter

Enter desired bearing or distance or select ABEAM.

**Note:** Bearing/distance from fix may be used as route waypoint.

### HSI Plan Mode Control

HSI Mode ..... PLAN

RTE LEGS page ..... Select

Map Center Step ..... Select

### Navaid Inhibit

To inhibit use of radio navigation aids from position updating:

INIT REF page ..... Select

INDEX page ..... Select

NAV DATA page ..... Select

Navaid Identifier ..... Enter

To inhibit use of a VOR and DME:

NAVAID line ..... Enter

To inhibit use of a VOR only:

VOR ONLY line ..... Enter

To inhibit use of all VORs:

VOR/DME NAV OFF/ON line ..... Select

ALL is displayed in the VOR ONLY inhibit line and OFF is displayed in large font.

## Update Active Navigation Database

The navigation database can be changed only on the ground. Changing the database removes all previously entered route data.

INIT REF ..... Select

IDENT page ..... Select

Inactive Date line ..... Select

Transfers inactive date range to scratchpad

Active Date line ..... Select

Transfers inactive database line to active database line. Transfers active database line to the inactive database line.

Intentionally  
Blank

**Fuel Balancing**

If an engine fuel leak is suspected:

Accomplish the ENGINE FUEL LEAK checklist

**Note:** Fuel pump pressure should be supplied to the engines at all times. At high altitude, without fuel pump pressure, thrust deterioration or engine flameout may occur.

When the fuel quantities in left main and right main tanks differ by an appreciable amount:

- Crossfeed switches (both)..... ON
- Fuel pump switches (low quantity tank) ..... OFF

When fuel load balanced:

- Fuel pump switches ..... ON
- Crossfeed switches (both)..... OFF

**Fuel Quantity Test**

Fuel Quantity Test switch ..... FUEL QTY

Observe FUEL CONFIG light illuminate and LOW FUEL message display

Observe fuel quantity indicators display all eights (8) except initial digit in total fuel quantity indicator which displays one (1). Observe fuel temperature indicator display -188° Centigrade.

Intentionally  
Blank



---

**EICAS Test**

This procedure requires the airplane to be on the ground and park brake set.

EICAS Test switch ..... Push

Wait 5 seconds and switch to L then R.

Observe TEST OK message displayed on CRTs in both positions.

**Note:** Standby engine indications will be displayed during test and siren aural will sound.

EICAS Test switch ..... Push

---

**Takeoff Configuration Warning Test**

Establish one or more of the following conditions:

Flaps not in takeoff position

Speedbrakes not down

Stabilizer units set greater than green band

Park brake set

Configuration Test switch ..... T/O

Observe CONFIG light illuminate, and appropriate configuration warning message(s) display.

Establish appropriate configuration.

---

**Landing Configuration Warning Test**

Configuration Test switch ..... LDG

Observe CONFIG light illuminate and GEAR NOT DOWN message display.

---

---

## Stall Warning Test

**CAUTION: With leading edge slats in takeoff position and left hydraulic system pressurized, leading edge slats will extend to landing position during test.**

L Stall Warning Test switch ..... STALL

Observe control columns vibrate.

R Stall Warning Test switch ..... STALL

Observe control columns vibrate.

---

---

## Event Record

All pages:

Event Record switch ..... Push

Use as directed by Flight Operations for maintenance analysis or at the discretion of the captain to manually record parameters for a suspect condition.

**Introduction**

Airplane operation in adverse weather conditions may require additional considerations due to the effects of extreme temperatures, precipitation, turbulence, and windshear. Procedures in this section supplement normal procedures and should be observed when applicable.

**Takeoff - Wet or Contaminated Runway Conditions**

The following information applies to takeoffs on wet or contaminated runways:

- For wet runways, reduced thrust (fixed derate, assumed temperature method, or both) is allowed provided suitable takeoff performance accountability is made for the increased stopping distance on a wet surface.
- For runways contaminated by slush, snow, standing water, or ice reduced thrust (fixed derate) is allowed provided takeoff performance accounts for the runway surface condition. Reduced thrust using assumed temperature method, whether alone or in combination with a fixed derate, is not allowed.
- V1 may be reduced to minimum V1 to provide increased stopping margin provided the field length required for a continued takeoff from the minimum V1 and obstacle clearance meet the regulatory requirements. The determination of such minimum V1 may require a real-time performance calculation tool or other performance information supplied by dispatch.
- Takeoffs are not recommended when slush, wet snow, or standing water depth is more than 1/2 inch (13 mm) or dry snow depth is more than 4 inches (102 mm).

---

---

## Cold Weather Operations

Considerations associated with cold weather operation are primarily concerned with low temperatures and with ice, snow, slush and standing water on the airplane, ramps, taxiways and runways.

Icing conditions exist when OAT (on the ground) or TAT (in-flight) is 10°C or below and any of the following exist:

- visible moisture (clouds, fog with visibility of one statute mile (1600 m) or less, due to metrological conditions such as rain, snow, sleet, ice crystals), or
- ice, snow, slush or standing water is present on the ramps, taxiways or runways.

**CAUTION: Do not use engine anti-ice when OAT (on the ground) is above 10°C. Do not use engine or wing anti-ice when TAT (in-flight) is above 10°C.**

## Exterior Inspection

Although removal of surface snow, ice and frost is normally a maintenance function, during preflight procedures, the captain or first officer should carefully inspect areas where surface snow, ice or frost could change or affect normal system operations.

Do the normal Exterior Inspection with the following additional steps:

Surfaces ..... Check

Takeoff with light coatings of frost, up to 1/8 inch (3mm) in thickness, on lower wing surfaces due to cold fuel is allowable; however, all leading edge devices, all control surfaces, and upper wing surfaces must be free of snow, ice and frost.

Thin hoarfrost is acceptable on the upper surface of the fuselage provided all vents and ports are clear. Thin hoarfrost is a uniform white deposit of fine crystalline texture, which usually occurs on exposed surfaces on a cold and cloudless night, and which is thin enough to distinguish surface features underneath, such as paint lines, markings or lettering.

Pitot probes and static ports ..... Check

Verify that all pitot probes and static ports are free of snow and ice. Water rundown after snow removal may freeze immediately forward of static ports and cause an ice buildup which disturbs airflow over the static ports resulting in erroneous static readings even when static ports are clear.

Air conditioning inlets and exits ..... Check  
Verify that the air inlets and exits, including the outflow valve, are free of snow and ice.

Engine inlets ..... Check  
Verify that the inlet cowling is free of snow and ice.

Fuel tank vents ..... Check  
Verify that all traces of ice and frost are removed.

Landing gear doors ..... Check  
Landing gear doors should be free of snow and ice.

APU air inlet ..... Check  
The APU inlet door must be free of snow and ice before APU start.

**Engine Start Procedure**

Do the normal Engine Start Procedure with the following considerations:

- Oil pressure may be slow to rise
- Initial oil pressure rise may be higher than normal
- Additional warm-up time may be needed to allow oil temperature to reach the normal range

**Engine Anti-ice Operation - On the Ground**

Engine anti-ice must be selected ON immediately after both engines are started and remain on during all ground operations when icing conditions exist or are anticipated, except when the temperature is below -40°C OAT.

**WARNING: Do not rely on airframe visual icing cues before activating engine anti-ice. Use the temperature and visible moisture criteria because late activation of engine anti-ice may allow excessive ingestion of ice and result in engine damage or failure.**

**CAUTION: Do not use engine anti-ice when OAT is above 10°C.**

When engine anti-ice is needed:

ENGINE ANTI-ICE switches .....ON F/O

When engine anti-ice is no longer needed:

ENGINE ANTI-ICE switches ..... Off F/O

---

## Before Taxi Procedure

Do the normal Before Taxi Procedure with the following modifications:

If taxi route is through ice, snow, slush or standing water in low temperatures or if precipitation is falling with temperatures below freezing, taxi out with the flaps up. Taxiing with the flaps extended subjects the flaps and flap drives to contamination. Leading edge devices are also susceptible to slush accumulations.

Call "FLAPS \_\_\_" as needed. C

Flap lever ..... Set flaps, as needed F/O

## Taxi-Out

**CAUTION: Taxi at a reduced speed. Use smaller tiller and rudder inputs, and apply minimum thrust evenly and smoothly. Taxiing on slippery taxiways or runways at excessive speed or with high crosswinds may start a skid.**

When engine anti-ice is required and the OAT is 3°C or below, do an engine run up, as needed, to minimize ice build-up. Use the following procedure: C

Check that the area behind the airplane is clear.

**Option: Rolls Royce Engines**

Run-up to a minimum of 60% N1 for approximately 10 seconds duration at intervals no greater than 60 minutes.

**Option: Pratt and Whitney Engines**

If the engine was visually inspected before start and found clear of ice:

Run-up to a minimum of 50% N1 for approximately 1 second duration at intervals no greater than 30 minutes.

**Option: Pratt and Whitney Engines**

If the engine was not inspected before start:

Run-up to a minimum of 50% N1 for approximately 1 second duration at intervals no greater than 15 minutes.

**De-icing / Anti-icing**

Testing of undiluted de-icing/anti-icing fluids has shown that some of the fluid remains on the wing during takeoff rotation and initial climb. The residual fluid causes a temporary decrease in lift and increase in drag, however, the effects are temporary. Use the normal takeoff rotation rate.

If de-icing / anti-icing is needed:

Call "FLAPS UP". C

Flaps ..... UP F/O  
Prevents ice and slush from accumulating in flap cavities during de-icing.

Thrust levers ..... Idle C  
Reduces the possibility of injury to personnel at inlet or exhaust areas.

Engine BLEED air switches ..... OFF F/O  
Reduces the possibility of fumes entering the air conditioning system.

APU BLEED air switch ..... OFF F/O  
Reduces the possibility of fumes entering the air conditioning system.

After de-icing / anti-icing is completed:

Wait approximately one minute after de-icing is completed to turn BLEED air switches on to ensure all de-icing fluid has been cleared from the engines:

Engine BLEED air switches ..... On F/O

APU BLEED air switch ..... On F/O

**Before Takeoff Procedure**

Do the normal Before Takeoff Procedure with the following modification:

Call "FLAPS \_\_\_" as needed for takeoff. PF

Flap lever ..... Set takeoff flaps, as needed PM  
Extend the flaps to the takeoff setting at this time if they have been held because of slush, standing water, or icing conditions, or because of exterior de-icing / anti-icing.

## Takeoff Procedure

Do the normal Takeoff Procedure with the following modification:

When engine anti-ice is required and the OAT is 3°C or below, the takeoff must be preceded by a static engine run-up.

Use the following procedure: PF

### Option: Rolls Royce Engines

Run-up to a minimum of 60% N1 for approximately 10 seconds duration and confirm stable engine operation before the start of the takeoff roll.

### Option: Pratt and Whitney Engines

Run-up to a minimum of 50% N1 and confirm stable engine operation before the start of the takeoff roll.

## Engine Anti-ice Operation - In-flight

Engine anti-ice must be ON during all flight operations when icing conditions exist or are anticipated, except during climb and cruise when the temperature is below -40°C SAT. Engine anti-ice must be on prior to and during descent in icing conditions, including temperatures below -40°C SAT.

**WARNING: Do not rely on airframe visual icing cues before activating engine anti-ice. Use the temperature and visible moisture criteria because late activation of engine anti-ice may allow excessive ingestion of ice and result in engine damage or failure.**

**CAUTION: Do not use engine anti-ice when TAT is above 10°C.**

When engine anti-ice is needed:

ENGINE ANTI-ICE switches ..... ON PM

When engine anti-ice is no longer needed:

ENGINE ANTI-ICE switches ..... Off PM

## Fan Ice Removal

### Option: Rolls Royce Engines

**CAUTION: Avoid prolonged operation in moderate to severe icing conditions.**



If moderate to severe icing conditions are encountered:

Increases in engine vibration above 2.5 units may occur due to fan icing. After a short period of time, this ice will normally shed and vibration will return to normal. If desired, do the following procedure on both engines, one engine at a time: quickly reduce thrust to idle for 5 seconds then restore the require thrust. If vibration persists, advance thrust lever to 90% N1 momentarily.

**Note:** Under all but very severe icing conditions, ice will shed when thrust is reduced to idle, eliminating the need to subsequently apply higher than desired thrust.

**Wing Anti-ice Operation - In-flight**

Ice accumulation on the flight deck window frames, windshield center post, or windshield wiper arm, or side windows may be used as an indication of structural icing conditions and the need to turn on wing anti-ice.

The wing anti-ice system may be used as a de-icer or anti-icer in flight only. The primary method is to use it as a de-icer by allowing ice to accumulate before turning wing anti-ice on. This procedure provides the cleanest airfoil surface, the least possible runback ice formation, and the least thrust and fuel penalty. Normally it is not necessary to shed ice periodically unless extended flight through icing conditions is necessary (holding).

The secondary method is to select the WING ANTI-ICE switch ON when wing icing is possible and use the system as an anti-icer.

**CAUTION: Do not use wing anti-ice when TAT is above 10°C.**

When wing anti-ice is needed:

WING ANTI-ICE switch ..... ON PM

When wing anti-ice is no longer needed:

WING ANTI-ICE switch ..... Off PM

---

## Cold Temperature Altitude Corrections

Extremely low temperatures create significant altimeter errors and greater potential for reduced terrain clearance. When the temperature is colder than ISA, true altitude will be lower than indicated altitude. Altimeter errors become significantly larger when the surface temperature approaches -30°C or colder, and also become larger with increasing height above the altimeter reference source.

Apply the altitude correction table when needed:

- no corrections are needed for reported temperatures above 0°C or if the airport temperature is at or above the minimum published temperature for the procedure being flown
- do not correct altimeter barometric reference settings
- ATC assigned altitudes or flight levels should not be adjusted for temperature when under radar control
- corrections apply to QNH and QFE operations
- apply corrections to all published minimum departure, en route and approach altitudes, including missed approach altitudes, according to the table below. Advise ATC of the corrections
- MDA/DA settings should be set at the corrected minimum altitudes for the approach
- subtract the elevation of the altimeter barometric reference setting source (normally the departure or destination airport elevation) from the published minimum altitude to be flown to determine “height above altimeter reference source”
- enter the table with Airport Temperature and with “height above altimeter reference source.” Read the correction where these two entries intersect. Add the correction to the published minimum altitude to be flown to determine the corrected indicated altitude to be flown. To correct an altitude above the altitude in the last column, use linear extrapolation (e.g., to correct 6000 feet or 1800 meters, use twice the correction for 3000 feet or 900 meters, respectively) The corrected altitude must always be greater than the published minimum altitude
- if the corrected indicated altitude to be flown is between 100 foot increments, set the MCP altitude to the closest 100 foot increment above the corrected indicated altitude to be flown.

**Altitude Correction Table - Heights and Altitudes in Feet**

Airport Temp °C	Height Above Altimeter Source											
	200 feet	300 feet	400 feet	500 feet	600 feet	700 feet	800 feet	900 feet	1000 feet	1500 feet	2000 feet	3000 feet
0°	20	20	30	30	40	40	50	50	60	90	120	170
-10°	20	30	40	50	60	70	80	90	100	150	200	290
-20°	30	50	60	70	90	100	120	130	140	210	280	420
-30°	40	60	80	100	120	140	150	170	190	280	380	570
-40°	50	80	100	120	150	170	190	220	240	360	480	720
-50°	60	90	120	150	180	210	240	270	300	450	590	890

**Altitude Correction Table - Heights and Altitudes in Meters**

Airport Temp °C	Height Above Altimeter Source											
	60 MTRS	90 MTRS	120 MTRS	150 MTRS	180 MTRS	210 MTRS	240 MTRS	270 MTRS	300 MTRS	450 MTRS	600 MTRS	900 MTRS
0°	5	5	10	10	10	15	15	15	20	25	35	50
-10°	10	10	15	15	20	20	25	30	30	45	60	90
-20°	10	15	20	25	25	30	35	40	45	65	85	130
-30°	15	20	25	30	35	40	45	55	60	85	115	170
-40°	15	25	30	40	45	50	60	65	75	110	145	220
-50°	20	30	40	45	55	65	75	80	90	135	180	270

## After Landing Procedure

**CAUTION: Taxi at a reduced speed. Use smaller tiller and rudder inputs, and apply minimum thrust evenly and smoothly. Taxiing on slippery taxiways or runways at excessive speed or with high crosswinds may start a skid.**

Do the normal After Landing Procedure with the following modifications:

After prolonged operation in icing conditions with the flaps extended, or when an accumulation of airframe ice is observed, or when operating on a runway or taxiway contaminated with ice, snow, slush or standing water:

Do not retract the flaps to less than flaps 20 until the flap areas have been checked to be free of contaminants.

Engine anti-ice must be selected ON and remain on during all ground operations when icing conditions exist or are anticipated, except when the temperature is below  $-40^{\circ}\text{C}$  OAT.

**WARNING: Do not rely on airframe visual icing cues before activating engine anti-ice. Use the temperature and visible moisture criteria because late activation of engine anti-ice may allow excessive ingestion of ice and result in engine damage or failure.**

**CAUTION: Do not use engine anti-ice when OAT is above  $10^{\circ}\text{C}$ .**

When engine anti-ice is needed:

ENGINE ANTI-ICE switches ..... ON F/O

When engine anti-ice is no longer needed:

ENGINE ANTI-ICE switches ..... Off F/O

When engine anti-ice is required and the OAT is  $3^{\circ}\text{C}$  or below, do an engine run up, as needed, to minimize ice build-up. Use the following procedure:

C

Check that the area behind the airplane is clear.

**Option: Pratt and Whitney Engines**

Run-up to a minimum of 50% N1 for approximately 1 second duration at intervals no greater than 15 minutes.

**Option: Rolls Royce Engines**

Run-up to a minimum of 60% N1 for approximately 10 seconds duration at intervals no greater than 60 minutes.

**Secure Procedure**

Do the normal Secure Procedure with the following modifications:

If the airplane will be attended:

PACK CONTROL selectors ..... AUTO            F/O

If the airplane will not be attended, or if staying overnight at off-line stations or at airports where normal support is not available, the flight crew must arrange for or verify that the following steps are done:

Cabin altitude mode selector ..... MAN            F/O

Cabin altitude manual control ..... DESCEND            F/O

Position the outflow valve fully closed to inhibit the intake of snow or ice.

Wheel chocks ..... Verify in place    C or F/O

Parking brake ..... Released            C

Reduces the possibility of frozen brakes.

Cold weather maintenance procedures for securing the airplane may be required. These procedures are found in the approved Aircraft Maintenance Manual.

## Hot Weather Operation

During ground operation the following considerations will help keep the airplane as cool as possible:

- If a ground source of conditioned air is available, the supply should be plugged in immediately after engine shutdown and should not be removed until either the APU or the engines are started.
- If a ground source of conditioned air is not available, use both air conditioning packs and recirculation fans.
- Keep all doors and windows, including cargo doors, closed as much as possible.
- Electronic components which contribute to a high temperature level in the flight deck should be turned off while not in use.
- Open all passenger cabin gasper outlets and close all window shades on the sun-exposed side of the passenger cabin.
- Open all flight deck air outlets.
- See Air Conditioning section in Limitations chapter.

**Note:** If only a ground source of conditioned air is supplied (no bleed air from the APU or ground external air), then TAT probes are not aspirated. Because of high TAT probe temperatures, the FMCs or TMSP may not accept an assumed temperature derate. Delay selecting an assumed temperature derate until after bleed air is available.

---

## Moderate to Heavy Rain, Hail or Sleet

Flight should be conducted to avoid thunderstorms, hail activity or visible moisture over storm cells. To the maximum extent possible, moderate to heavy rain, hail or sleet should also be avoided.

**Turbulence**

During flight in light to moderate turbulence, the autopilot may remain engaged unless airspeed, altitude or attitude deviations require use of manual control. The turbulent air penetration speed is 290 knots/.78 Mach. Below 10,000 feet a speed between 240 and 250 knots provides adequate buffet margin.

Passenger Signs ..... ON

Advise passengers to fasten seat belts prior to entering areas of reported or anticipated turbulence. Instruct flight attendants to check all passengers' seat belts are fastened.

**Severe Turbulence**

Severe turbulence should be avoided if at all possible. If severe turbulence cannot be avoided, an increased buffet margin is recommended. This can be obtained by descending approximately 4,000 feet below optimum altitude. The autothrottle should be off in severe turbulence.

## **Windshear**

Windshear is a change of wind speed and/or direction over a short distance along the flight path. Indications of windshear are listed in the Windshear non-normal maneuver in this manual.

### **Avoidance**

The flight crew should search for any clues to the presence of windshear along the intended flight path. The presence of windshear may be indicated by:

- Thunderstorm activity
- Virga (rain that evaporates before reaching the ground)
- Pilot reports
- Low level windshear alerting system (LLWAS) warnings.

Stay clear of thunderstorm cells and heavy precipitation and areas of known windshear. If presence of windshear is confirmed, delay takeoff or do not continue an approach.



## Precautions

If windshear is suspected, be especially alert to any of the danger signals and be prepared for the possibility of an inadvertent encounter. The following precautionary actions are recommended if windshear is suspected:

### Takeoff

- Use maximum takeoff thrust instead of reduced thrust.
- For optimum takeoff performance, use Flaps 20 for takeoff unless limited by obstacle clearance and/or climb gradient. Flaps 15 may also be used as a precautionary setting and will provide nearly equivalent performance to Flaps 20.
- Use the longest suitable runway provided it is clear of areas of known windshear.
- Use the flight director after takeoff.
- Consider increasing  $V_r$  speed to the performance limited gross weight rotations speed, not to exceed actual gross weight  $V_r+20$  knots. Set  $V$  speeds for the actual gross weight. Rotate at the adjusted (higher) rotation speed. This increased rotation speed results in an increased stall margin, and meets takeoff performance requirements. If windshear is encountered at or beyond the actual gross weight  $V_r$ , do not attempt to accelerate to the increased  $V_r$ , but rotate without hesitation.
- Be alert for any airspeed fluctuations during takeoff and initial climb. Such fluctuations may be the first indication of windshear.
- Know the all-engine initial climb pitch attitude. Rotate at the normal rate to this attitude for all non-engine failure takeoffs. Minimize reductions from the initial climb pitch attitude until terrain and obstruction clearance is assured, unless stick shaker activates.
- Crew coordination and awareness are very important. Develop an awareness of normal values of airspeed, attitude, vertical speed and airspeed build-up. Closely monitor vertical flight path instruments such as vertical speed and altimeters. The pilot monitoring should be especially aware of vertical path instruments and call out any deviations from normal.
- Should airspeed fall below the trim airspeed, unusual control column forces may be required to maintain the desired pitch attitude. Stick shaker must be respected at all times.

## Approach and Landing

- Use either Flaps 25 or 30 for landing.
- Establish a stabilized approach no lower than 1000 feet above the airport to improve windshear recognition capability.
- Use the most suitable runway that avoids the areas of suspected windshear and is compatible with crosswind or tailwind limitations. Use ILS G/S, VNAV path or VASI/PAPI indications to detect flight path deviations and help with timely detection of windshear.
- If the autothrottle is disengaged, or is planned to be disengaged prior to landing, add an appropriate airspeed correction (correction applied in the same manner as gust), up to a maximum of 20 knots.
- Avoid large thrust reductions or trim changes in response to sudden airspeed increases as these may be followed by airspeed decreases.
- Crosscheck flight director commands using vertical flight path instruments.
- Crew coordination and awareness are very important, particularly at night or in marginal weather conditions. Closely monitor the vertical flight path instruments such as vertical speed, altimeters and glide slope displacement. The pilot monitoring should call out any deviations from normal. Use of the autopilot and autothrottle for the approach may provide more monitoring and recognition time.

## Recovery

Accomplish the WINDSHEAR maneuver found in the Maneuvers section of this manual.

# **DO NOT USE FOR FLIGHT**

757 Flight Crew Operations Manual

## **Performance Inflight**

## **Chapter PI**

### **Table of Contents**

<b>757-200 535E4 LB FAA</b>	<b>----- PI.10.1</b>
<b>757-200 PW2037 LB FAA</b>	<b>----- PI.20.1</b>

Intentionally  
Blank

**757-200 535E4 LB FAA**

**General ..... PI.10.1**

- Takeoff Speeds ..... PI.10.1
- V1(MCG) ..... PI.10.2
- Maximum Allowable Clearway ..... PI.10.2
- Clearway and Stopway V1 Adjustments ..... PI.10.2
- Stab Trim Setting ..... PI.10.2
- VREF (KIAS) ..... PI.10.3
- Flap Maneuver Speeds ..... PI.10.4
- Slush/Standing Water Takeoff ..... PI.10.5
- Slippery Runway Takeoff ..... PI.10.7
- Takeoff EPR ..... PI.10.11
- Assumed Temperature Reduced Thrust ..... PI.10.11
- Max Climb EPR ..... PI.10.12
- Go-around EPR ..... PI.10.13
- Flight With Unreliable Airspeed / Turbulent Air Penetration PI.10.14

**All Engine ..... PI.11.1**

- Long Range Cruise Maximum Operating Altitude ..... PI.11.1
- Long Range Cruise Control ..... PI.11.2
- Long Range Cruise Enroute Fuel and Time - Low Altitudes . PI.11.3
- Long Range Cruise Enroute Fuel and Time - High Altitudes PI.11.4
- Long Range Cruise Wind-Altitude Trade ..... PI.11.5
- Descent at .78/290/250 ..... PI.11.5
- Holding ..... PI.11.5

**Advisory Information ..... PI.12.1**

- Normal Configuration Landing Distance ..... PI.12.1
- Non-Normal Configuration Landing Distance ..... PI.12.3
- Recommended Brake Cooling Schedule ..... PI.12.11

---

**Engine Inoperative . . . . . PI.13.1**

Initial Max Continuous EPR . . . . . PI.13.1  
Max Continuous EPR . . . . . PI.13.2  
Driftdown Speed/Level Off Altitude. . . . . PI.13.4  
Driftdown/LRC Cruise Range Capability. . . . . PI.13.4  
Long Range Cruise Altitude Capability . . . . . PI.13.5  
Long Range Cruise Control . . . . . PI.13.6  
Long Range Cruise Diversion Fuel and Time. . . . . PI.13.7  
Holding . . . . . PI.13.8

**Alternate Thrust Setting. . . . . PI.14.1**

Takeoff Performance . . . . . PI.14.1  
Takeoff Speeds . . . . . PI.14.1  
Enroute Performance. . . . . PI.14.1  
Landing Performance . . . . . PI.14.1  
Takeoff %N1 . . . . . PI.14.2  
Go-around %N1 . . . . . PI.14.3  
Max Climb %N1 . . . . . PI.14.4  
Max Cruise %N1. . . . . PI.14.4

**Alternate Thrust Setting, Engine Inoperative . . . . . PI.14.5**

Initial Max Continuous %N1 . . . . . PI.14.5  
Max Continuous %N1. . . . . PI.14.6

**Gear Down. . . . . PI.15.1**

210 KIAS Max Climb EPR. . . . . PI.15.1  
Long Range Cruise Altitude Capability . . . . . PI.15.1  
Long Range Cruise Control . . . . . PI.15.2  
Long Range Cruise Enroute Fuel and Time . . . . . PI.15.3  
Descent at VREF30 + 80. . . . . PI.15.3  
Holding . . . . . PI.15.4

**Gear Down, Engine Inoperative . . . . . PI.16.1**

Driftdown Speed/Level Off Altitude. . . . . PI.16.1  
Long Range Cruise Altitude Capability . . . . . PI.16.1

Long Range Cruise Control . . . . .	PI.16.2
Long Range Cruise Diversion Fuel and Time . . . . .	PI.16.3
Holding . . . . .	PI.16.4
<b>Text . . . . .</b>	<b>PI.17.1</b>
Introduction . . . . .	PI.17.1
General . . . . .	PI.17.1
All Engines . . . . .	PI.17.5
Advisory Information . . . . .	PI.17.7
Engine Inoperative . . . . .	PI.17.9
Alternate Thrust Setting . . . . .	PI.17.11
Alternate Thrust Setting, Engine Inoperative . . . . .	PI.17.12
Gear Down . . . . .	PI.17.12

Intentionally  
Blank



**Performance Inflight**  
**General**

**Chapter PI**  
**Section 10**

**Takeoff Speeds**  
**Max Takeoff Thrust**

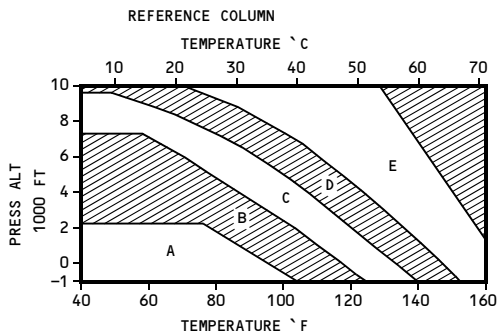

SLOPE/WIND V1

ADJUSTMENT

WEIGHT 1000 LB	SLOPE %			WIND KTS		
	-2	0	2	-15	0	20 40
260	-2	0	3	-2	0	1 1
240	-2	0	3	-2	0	1 2
220	-2	0	3	-2	0	1 2
200	-1	0	3	-2	0	1 2
180	-1	0	3	-2	0	1 2
160	-1	0	3	-2	0	1 2

FLAPS	WEIGHT (1000 LB)	A			B			C			D			E		
		V1	VR	V2	V1	VR	V2	V1	VR	V2	V1	VR	V2	V1	VR	V2
1	260	176	179	184	178	181	184	181	183	184						
	240	167	171	176	169	173	176	172	175	177	175	176	177	177	177	177
	220	157	162	169	160	164	169	163	166	169	165	167	169	168	169	170
	200	147	153	161	150	154	161	153	156	161	156	158	161	159	160	161
	180	137	143	152	139	144	152	142	146	152	145	148	152	149	151	153
	160	126	132	141	129	134	144	131	136	144	134	138	144	138	141	144
5	260	161	165	169	164	167	169	166	169	169						
	240	153	157	162	156	159	162	158	161	162	161	162	163	163	163	163
	220	144	149	155	147	151	155	150	153	155	152	154	156	155	156	156
	200	135	141	148	138	142	148	141	144	148	143	146	148	146	148	149
	180	125	132	140	128	133	140	131	135	140	134	137	140	137	139	141
	160	117	123	132	118	124	132	120	125	132	123	127	132	126	129	132
15	260	154	157	160	156	159	160	158	160	160						
	240	145	149	153	148	151	153	150	153	153	153	154	154			
	220	136	141	147	139	143	147	142	145	147	144	146	147	147	147	147
	200	128	134	140	130	135	140	133	137	140	136	138	140	139	140	141
	180	118	125	132	121	126	132	124	128	133	126	130	133	130	132	133
	160	108	116	125	111	118	125	114	119	125	116	121	125	120	123	125
20	260	145	148	152	147	149	152									
	240	137	141	146	139	143	146	142	144	146						
	220	129	134	139	132	136	140	135	137	140	136	138	140			
	200	120	126	133	123	128	133	126	129	133	128	131	133	131	132	134
	180	111	118	126	114	120	126	117	121	126	120	123	126	122	125	127
	160	103	111	119	105	112	119	108	113	119	110	114	119	113	117	119

Check Minimum V1 (MCG) in shaded area.

**V1(MCG)**

**Max Takeoff Thrust**

ACTUAL OAT		PRESSURE ALTITUDE (FT)					
°F	°C	0	2000	4000	6000	8000	10000
131	55	94					
122	50	97	93	90			
113	45	99	95	92	88		
104	40	101	98	94	90	87	
95	35	103	100	96	92	89	84
86	30	105	102	98	94	90	86
77	25	106	103	100	96	92	87
68	20	106	103	101	97	93	89
59	15	106	103	101	98	95	90
50 & BELOW	10 & BELOW	106	104	101	98	95	91

**Maximum Allowable Clearway**

FIELD LENGTH (FT)	MAX ALLOWABLE CLEARWAY FOR V1 REDUCTION (FT)
4000	350
6000	450
8000	550
10000	650
12000	700
14000	800

**Clearway and Stopway V1 Adjustments**

CLEARWAY MINUS STOPWAY (FT)	NORMAL V1 (KIAS)			
	120	140	160	180
800	-6	-4	-2	-1
600	-4	-3	-2	-1
400	-3	-2	-1	-1
200	-1	-1	-1	0
0	0	0	0	0
-200	1	1	1	0
-400	3	2	1	1
-600	4	3	2	1
-800	6	4	2	1

**Stab Trim Setting**

WEIGHT (1000 LB)	C.G. %MAC						
	9	14	19	24	29	34	39
260	7	7	6	5	4 1/4	3 1/4	2 1/2
240	7	6 3/4	5 1/2	4 1/2	4	3 1/4	2 1/2
220	7	6 1/4	5 1/4	4 1/4	3 3/4	3	2 1/2
200	7	6	4 3/4	4	3 1/2	2 3/4	2 1/4
180	6 1/2	5 1/2	4 1/2	3 3/4	3 1/4	2 1/2	2 1/4
160	6	5	4 1/4	3 1/2	3	2 1/4	2

---

**VREF (KIAS)**

WEIGHT (1000 LB)	FLAPS		
	30	25	20
260	155	157	165
240	148	150	158
220	140	142	151
200	133	135	144
180	125	127	136
160	117	119	128
140	109	111	119

---

## Flap Maneuver Speeds

FLAP POSITION	MANEUVER SPEED
UP	VREF30 + 80
1	VREF30 + 60
5	VREF30 + 40
15	VREF30 + 20
20	VREF30 + 20
25	VREF25
30	VREF30

**ADVISORY INFORMATION**

**Slush/Standing Water Takeoff**  
**Maximum Reverse Thrust**  
**Weight Adjustment (1000 LB)**

FIELD/ OBSTACLE LIMIT WEIGHT (1000 LB)	SLUSH/STANDING WATER DEPTH								
	0.12 INCHES (3 mm)			0.25 INCHES (6 mm)			0.50 INCHES (13 mm)		
	PRESS ALT (FT)			PRESS ALT (FT)			PRESS ALT (FT)		
	S.L.	4000	8000	S.L.	4000	8000	S.L.	4000	8000
280	-30.6	-32.0	-32.4	-35.8	-36.2	-34.8	-47.6	-46.4	-41.9
260	-28.6	-30.6	-31.8	-33.6	-35.2	-35.3	-44.6	-46.2	-44.4
240	-25.8	-28.2	-30.2	-30.3	-32.9	-34.4	-40.3	-43.9	-44.8
220	-22.5	-25.1	-27.6	-26.3	-29.5	-32.2	-34.8	-39.7	-43.0
200	-18.7	-21.3	-24.2	-21.8	-25.1	-28.6	-28.6	-33.9	-39.0
180	-14.8	-17.2	-19.9	-17.0	-20.1	-23.8	-21.9	-26.6	-32.9
160	-10.8	-12.7	-15.0	-12.3	-14.5	-17.7	-15.2	-18.3	-24.5

**V1(MCG) Limit Weight (1000 LB)**

ADJUSTED FIELD LENGTH (FT)	SLUSH/STANDING WATER DEPTH								
	0.12 INCHES (3 mm)			0.25 INCHES (6 mm)			0.50 INCHES (13 mm)		
	PRESS ALT (FT)			PRESS ALT (FT)			PRESS ALT (FT)		
	S.L.	4000	8000	S.L.	4000	8000	S.L.	4000	8000
4200							132.5		
4600	132.9			146.7			168.6	135.1	
5000	171.7	129.8		185.1	144.1		206.7	165.9	139.2
5400	213.2	163.0	131.1	226.4	176.8	145.4	246.8	198.2	166.1
5800	257.3	197.8	160.3	269.8	211.5	174.0	288.4	232.0	194.0
6200	303.1	234.8	190.6	314.4	248.0	204.0		266.8	222.8
6600		273.3	222.4		285.6	235.2		302.3	252.3
7000		312.6	255.4			267.2			282.3
7400			289.1			299.7			312.5

1. Enter Weight Adjustment table with slush/standing water depth and field/obstacle limit weight to obtain slush/standing water weight adjustment.
2. Adjust field length available -100 ft/+100 ft for every 10°F above/below 40°F.
3. Find V1(MCG) limit weight for adjusted field length and pressure altitude.
4. Max allowable slush/standing water limited weight is lesser of weights from 1 and 3.

**V1 Adjustment (KIAS)**

WEIGHT (1000 LB)	SLUSH/STANDING WATER DEPTH								
	0.12 INCHES (3 mm)			0.25 INCHES (6 mm)			0.50 INCHES (13 mm)		
	PRESS ALT (FT)			PRESS ALT (FT)			PRESS ALT (FT)		
	S.L.	4000	8000	S.L.	4000	8000	S.L.	4000	8000
280	-18	-15	-11	-11	-12	-11	-5	-11	-9
260	-19	-16	-14	-13	-13	-12	-4	-8	-9
240	-19	-18	-16	-14	-13	-12	-4	-6	-8
220	-20	-19	-17	-15	-14	-13	-5	-4	-6
200	-20	-19	-18	-17	-15	-13	-7	-4	-3
180	-21	-20	-18	-18	-16	-13	-10	-5	-3
160	-21	-20	-18	-19	-17	-14	-13	-8	-3

1. Obtain V1, VR and V2 for the actual weight.
2. If V1(MCG) limited, set V1 = V1(MCG). If not V1(MCG) limited, enter V1 Adjustment table with the actual weight to obtain V1 speed adjustment. If adjusted V1 is less than V1(MCG), set V1 = V1(MCG). V1 not to exceed VR.

**ADVISORY INFORMATION**

**Slush/Standing Water Takeoff**

**No Reverse Thrust**

**Weight Adjustment (1000 LB)**

FIELD/ OBSTACLE LIMIT WEIGHT (1000 LB)	SLUSH/STANDING WATER DEPTH								
	0.12 INCHES (3 mm)			0.25 INCHES (6 mm)			0.50 INCHES (13 mm)		
	PRESS ALT (FT)			PRESS ALT (FT)			PRESS ALT (FT)		
	S.L.	4000	8000	S.L.	4000	8000	S.L.	4000	8000
280	-37.8	-40.0	-41.4	-43.7	-45.1	-44.3	-57.1	-56.9	-51.7
260	-35.0	-37.6	-39.9	-40.4	-43.1	-44.1	-52.7	-55.7	-54.1
240	-31.5	-34.3	-37.3	-36.1	-39.6	-42.4	-46.7	-51.8	-54.3
220	-27.0	-29.9	-33.4	-30.8	-34.6	-38.7	-39.4	-45.6	-51.3
200	-22.7	-25.3	-28.6	-25.6	-29.2	-33.5	-32.3	-38.3	-45.3
180	-18.4	-20.8	-23.9	-20.7	-23.8	-27.9	-25.7	-30.7	-37.4
160	-14.4	-16.4	-19.0	-15.9	-18.5	-21.8	-19.5	-22.9	-27.8

**V1(MCG) Limit Weight (1000 LB)**

ADJUSTED FIELD LENGTH (FT)	SLUSH/STANDING WATER DEPTH								
	0.12 INCHES (3 mm)			0.25 INCHES (6 mm)			0.50 INCHES (13 mm)		
	PRESS ALT (FT)			PRESS ALT (FT)			PRESS ALT (FT)		
	S.L.	4000	8000	S.L.	4000	8000	S.L.	4000	8000
5000							134.8		
5400				125.8			173.9	135.1	
5800	134.7			169.7	120.7		216.4	168.1	139.5
6200	185.2			218.3	157.2	122.3	261.2	203.3	168.2
6600	239.0	162.3		269.5	197.1	155.2	306.6	240.3	198.2
7000	296.2	207.0	154.9		239.3	189.5		278.1	229.5
7400		253.3	193.2		282.5	225.2		316.0	261.4
7800		301.5	232.8			261.8			293.4
8200			274.0			298.5			
8600			315.4						

1. Enter Weight Adjustment table with slush/standing water depth and field/obstacle limit weight to obtain slush/standing water weight adjustment.
2. Adjust field length available by -140 ft/+140 ft for every 10°F above/below 40°F.
3. Find V1(MCG) limit weight for adjusted field length and pressure altitude.
4. Max allowable slush/standing water limited weight is lesser of weights from 1 and 3.

**V1 Adjustment (KIAS)**

WEIGHT (1000 LB)	SLUSH/STANDING WATER DEPTH								
	0.12 INCHES (3 mm)			0.25 INCHES (6 mm)			0.50 INCHES (13 mm)		
	PRESS ALT (FT)			PRESS ALT (FT)			PRESS ALT (FT)		
	S.L.	4000	8000	S.L.	4000	8000	S.L.	4000	8000
280	-26	-25	-21	-19	-18	-17	-5	-9	-16
260	-27	-26	-23	-21	-20	-18	-7	-9	-14
240	-29	-27	-24	-23	-21	-19	-9	-10	-12
220	-31	-29	-26	-25	-23	-20	-12	-10	-10
200	-32	-30	-27	-28	-24	-21	-15	-11	-9
180	-34	-32	-29	-30	-27	-22	-20	-14	-9
160	-35	-33	-30	-32	-29	-25	-25	-19	-11

1. Obtain V1, VR and V2 for the actual weight.
2. If V1(MCG) limited, set V1 = V1(MCG). If not V1(MCG) limited, enter V1 Adjustment table with the actual weight to obtain V1 speed adjustment. If adjusted V1 is less than V1(MCG), set V1 = V1(MCG). V1 not to exceed VR.

**Slippery Runway Takeoff**  
**Maximum Reverse Thrust**  
**Weight Adjustment (1000 LB)**

FIELD/ OBSTACLE LIMIT WEIGHT (1000 LB)	REPORTED BRAKING ACTION								
	GOOD			MEDIUM			POOR		
	PRESS ALT (FT)			PRESS ALT (FT)			PRESS ALT (FT)		
	S.L.	4000	8000	S.L.	4000	8000	S.L.	4000	8000
280	-4.7	-5.5	-6.3	-19.7	-20.5	-21.3	-31.6	-33.1	-34.5
260	-5.8	-6.6	-7.4	-19.3	-20.1	-20.9	-29.7	-31.2	-32.7
240	-6.2	-7.0	-7.8	-18.4	-19.2	-20.0	-27.5	-29.0	-30.5
220	-5.9	-6.7	-7.5	-17.0	-17.8	-18.6	-25.0	-26.4	-27.9
200	-5.1	-5.9	-6.7	-15.1	-15.9	-16.7	-21.9	-23.4	-24.9
180	-4.0	-4.8	-5.6	-12.7	-13.5	-14.3	-18.3	-19.8	-21.3
160	-2.7	-3.5	-4.3	-9.9	-10.7	-11.5	-14.1	-15.6	-17.1

**V1(MCG) Limit Weight (1000 LB)**

ADJUSTED FIELD LENGTH (FT)	REPORTED BRAKING ACTION								
	GOOD			MEDIUM			POOR		
	PRESS ALT (FT)			PRESS ALT (FT)			PRESS ALT (FT)		
	S.L.	4000	8000	S.L.	4000	8000	S.L.	4000	8000
3400	133.8								
3800	204.5								
4200	271.3	169.7							
4600		238.4	133.8	138.9					
5000		303.9	204.5	186.3					
5400			271.3	237.3	162.2				
5800				290.2	211.4	138.9	123.2		
6200					263.7	186.3	150.3		
6600					316.7	237.3	178.5	123.2	
7000						290.2	209.2	150.3	
7400							242.5	178.5	123.2
7800							277.9	209.2	150.3
8200							313.8	242.5	178.5
8600								277.9	209.2
9000								313.8	242.5
9400									277.9
9800									313.8

1. Enter Weight Adjustment table with reported braking action and field/obstacle limit weight to obtain slippery runway weight adjustment.
2. Adjust "Good" field length available by -100 ft/+100 ft for every 10°F above/below 40°F.  
Adjust "Medium" field length available by -100 ft/+100 ft for every 10°F above/below 40°F.  
Adjust "Poor" field length available by -150 ft/+150 ft for every 10°F above/below 40°F.
3. Find V1(MCG) limit weight for adjusted field length and pressure altitude.
4. Max allowable slippery runway limited weight is lesser of weights from 1 and 3.

**Slippery Runway Takeoff**  
**Maximum Reverse Thrust**  
**V1 Adjustment (KIAS)**

WEIGHT (1000 LB)	REPORTED BRAKING ACTION								
	GOOD			MEDIUM			POOR		
	PRESS ALT (FT)			PRESS ALT (FT)			PRESS ALT (FT)		
	S.L.	4000	8000	S.L.	4000	8000	S.L.	4000	8000
280	-6	-4	-2	-15	-13	-11	-28	-24	-20
260	-8	-6	-4	-18	-16	-14	-31	-27	-23
240	-9	-7	-5	-20	-18	-16	-33	-29	-25
220	-10	-8	-6	-22	-20	-18	-36	-32	-28
200	-11	-9	-7	-23	-21	-19	-38	-34	-30
180	-12	-10	-8	-25	-23	-21	-40	-36	-32
160	-13	-11	-9	-26	-24	-22	-41	-37	-33

1. Obtain V1, VR and V2 for the actual weight.
2. If V1(MCG) limited, set V1 = V1(MCG). If not V1(MCG) limited, enter V1 Adjustment table with the actual weight to obtain V1 speed adjustment. If adjusted V1 is less than V1(MCG), set V1 = V1(MCG). V1 not to exceed VR.



**Slippery Runway Takeoff**  
**No Reverse Thrust**  
**Weight Adjustment (1000 LB)**

FIELD/ OBSTACLE LIMIT WEIGHT (1000 LB)	REPORTED BRAKING ACTION								
	GOOD			MEDIUM			POOR		
	PRESS ALT (FT)			PRESS ALT (FT)			PRESS ALT (FT)		
	S.L.	4000	8000	S.L.	4000	8000	S.L.	4000	8000
280	-5.0	-5.8	-6.6	-22.4	-23.2	-24.0	-35.3	-36.9	-38.5
260	-6.7	-7.5	-8.3	-22.5	-23.3	-24.1	-33.4	-35.0	-36.6
240	-7.7	-8.5	-9.3	-21.6	-22.4	-23.2	-31.2	-32.8	-34.4
220	-6.9	-7.7	-8.5	-19.3	-20.1	-20.9	-27.7	-29.3	-30.9
200	-5.8	-6.6	-7.4	-16.8	-17.6	-18.4	-24.3	-25.9	-27.5
180	-4.7	-5.5	-6.3	-14.5	-15.3	-16.1	-20.9	-22.5	-24.1
160	-3.9	-4.7	-5.5	-12.2	-13.0	-13.8	-17.4	-19.0	-20.6

**V1(MCG) Limit Weight (1000 LB)**

ADJUSTED FIELD LENGTH (FT)	REPORTED BRAKING ACTION								
	GOOD			MEDIUM			POOR		
	PRESS ALT (FT)			PRESS ALT (FT)			PRESS ALT (FT)		
	S.L.	4000	8000	S.L.	4000	8000	S.L.	4000	8000
3800	151.6								
4200	238.5	130.5							
4600	311.8	222.8							
5000		297.3	206.5						
5400			282.8						
5800				188.9					
6200				260.5	174.1				
6600					246.6	159.3			
7000					315.0	232.6			
7400						301.4			
8200							135.2		
8600							174.4		
9000							217.0	131.4	
9400							265.3	170.3	
9800							316.1	212.7	127.6
10200								260.2	166.3
10600								311.0	208.5
11000									255.2
11400									305.9

1. Enter Weight Adjustment table with reported braking action and field/obstacle limit weight to obtain slippery runway weight adjustment.
2. Adjust "Good" field length available by -100 ft/+100 ft for every 10°F above/below 40°F. Adjust "Medium" field length available by -100 ft/+100 ft for every 10°F above/below 40°F. Adjust "Poor" field length available by -160 ft/+160 ft for every 10°F above/below 40°F.
3. Find V1(MCG) limit weight for adjusted field length and pressure altitude.
4. Max allowable slippery runway limited weight is lesser of weights from 1 and 3.

**Slippery Runway Takeoff**

**No Reverse Thrust**

**V1 Adjustment (KIAS)**

WEIGHT (1000 LB)	REPORTED BRAKING ACTION								
	GOOD			MEDIUM			POOR		
	PRESS ALT (FT)			PRESS ALT (FT)			PRESS ALT (FT)		
	S.L.	4000	8000	S.L.	4000	8000	S.L.	4000	8000
280	-10	-7	-4	-22	-19	-16	-40	-35	-30
260	-12	-9	-6	-25	-22	-19	-44	-39	-34
240	-14	-11	-8	-28	-25	-22	-48	-43	-38
220	-16	-13	-10	-31	-28	-25	-51	-46	-41
200	-18	-15	-12	-34	-31	-28	-54	-49	-44
180	-19	-16	-13	-36	-33	-30	-56	-51	-46
160	-21	-18	-15	-38	-35	-32	-59	-54	-49

1. Obtain V1, VR and V2 for the actual weight.
2. If V1(MCG) limited, set V1 = V1(MCG). If not V1(MCG) limited, enter V1 Adjustment table with the actual weight to obtain V1 speed adjustment. If adjusted V1 is less than V1(MCG), set V1 = V1(MCG). V1 not to exceed VR.

**Takeoff EPR**

Based on engine bleed for packs on and anti-ice off

AIRPORT OAT		AIRPORT PRESSURE ALTITUDE (FT)						
°F	°C	-1000	0	2000	4000	6000	8000	10000
158	70	1.47	1.47	1.47	1.47	1.47	1.47	1.47
149	65	1.51	1.51	1.50	1.50	1.50	1.50	1.50
140	60	1.54	1.54	1.54	1.53	1.53	1.53	1.53
131	55	1.57	1.57	1.57	1.56	1.56	1.57	1.56
122	50	1.60	1.60	1.60	1.60	1.60	1.60	1.58
113	45	1.63	1.63	1.63	1.63	1.63	1.63	1.61
104	40	1.66	1.65	1.66	1.66	1.66	1.66	1.64
95	35	1.68	1.68	1.68	1.69	1.69	1.69	1.67
86	30	1.71	1.71	1.71	1.72	1.72	1.72	1.70
77	25	1.71	1.72	1.74	1.74	1.74	1.74	1.72
68	20	1.71	1.72	1.74	1.76	1.77	1.76	1.75
59	15	1.71	1.72	1.74	1.76	1.78	1.78	1.77
50 & BELOW	10 & BELOW	1.71	1.72	1.74	1.76	1.78	1.79	1.79

**EPR Adjustments for Engine Bleeds**

BLEED CONFIGURATION	AIRPORT PRESSURE ALTITUDE (FT)			
	-1000	8000	8001	10000
PACKS OFF	0.01	0.01	0.01	0.01
ENGINE ANTI-ICE ON	0.00	0.00	-0.01	-0.01
ENGINE & WING ANTI-ICE ON	-0.01	-0.01	-0.02	-0.02

**Assumed Temperature Reduced Thrust**

Based on 25% thrust reduction

MINIMUM ALLOWABLE EPR FOR REDUCED THRUST			
MAX TAKEOFF EPR FOR ACTUAL OAT	MIN TAKEOFF EPR ALLOWED		
	FULL	TO1	TO2
1.80	1.60		
1.75	1.56	1.54	
1.70	1.53	1.50	
1.65	1.49	1.47	1.45
1.60	1.45	1.43	1.42
1.55	1.41	1.40	1.38
1.50		1.36	1.35
1.45			1.31

**Max Climb EPR**

**Based on engine bleed for packs on and anti-ice off**

TAT (°C)	PRESSURE ALTITUDE (1000 FT) / SPEED (KIAS OR MACH)								
	0	5	10	15	20	25	30	35	40
	250	250	250	290	290	290	290	.78	.78
60	1.41	1.41	1.40	1.40	1.40	1.39	1.39	1.39	1.38
50	1.45	1.45	1.45	1.45	1.44	1.43	1.44	1.44	1.43
40	1.50	1.50	1.50	1.50	1.49	1.49	1.49	1.49	1.48
30	1.52	1.56	1.55	1.55	1.55	1.54	1.54	1.55	1.53
20	1.52	1.57	1.61	1.61	1.61	1.60	1.60	1.61	1.60
10	1.52	1.57	1.61	1.66	1.67	1.66	1.67	1.67	1.66
0	1.52	1.57	1.61	1.66	1.69	1.72	1.72	1.73	1.72
-10	1.52	1.57	1.61	1.66	1.69	1.72	1.75	1.77	1.76
-20 & BELOW	1.52	1.57	1.61	1.66	1.69	1.72	1.75	1.79	1.80

**EPR Adjustments for Engine Bleeds**

BLEED CONFIGURATION	PRESSURE ALTITUDE (1000 FT)								
	0	5	10	15	20	25	30	35	40
PACKS OFF	0.01	0.01	0.01	0.01	0.01	0.01	0.01	0.01	0.01
ENGINE ANTI-ICE ON	-0.01	-0.01	-0.01	-0.01	-0.01	-0.01	-0.01	-0.02	-0.02
ENGINE & WING ANTI-ICE ON	-0.02	-0.02	-0.02	-0.02	-0.02	-0.03	-0.03	-0.04	-0.05

**Go-around EPR**

**Based on engine bleed for packs on and anti-ice off**

REPORTED OAT		TAT (°C)	AIRPORT PRESSURE ALTITUDE (FT)						
°F	°C		-1000	0	2000	4000	6000	8000	10000
131	55	58	1.57	1.56	1.57	1.57	1.57	1.57	1.55
122	50	53	1.59	1.59	1.59	1.60	1.60	1.59	1.57
113	45	48	1.62	1.62	1.62	1.63	1.63	1.62	1.60
104	40	43	1.65	1.65	1.65	1.66	1.66	1.65	1.63
95	35	38	1.67	1.67	1.68	1.69	1.68	1.68	1.66
86	30	33	1.70	1.70	1.70	1.71	1.71	1.71	1.69
77	25	28	1.70	1.71	1.73	1.74	1.74	1.73	1.71
68	20	23	1.70	1.71	1.73	1.76	1.76	1.76	1.74
59	15	18	1.70	1.71	1.73	1.76	1.77	1.78	1.76
50 & BELOW	10 & BELOW	13 & BELOW	1.70	1.71	1.73	1.76	1.77	1.78	1.79

**EPR Adjustments for Engine Bleeds**

BLEED CONFIGURATION	AIRPORT PRESSURE ALTITUDE (FT)								
	-1000	0	2000	4000	6000	8000	8001	10000	
PACKS OFF	0.01	0.01	0.01	0.01	0.01	0.01	0.01	0.01	
ENGINE ANTI-ICE ON	0.00	0.00	0.00	0.00	0.00	0.00	-0.01	-0.01	
ENGINE & WING ANTI-ICE ON	-0.01	-0.01	-0.01	-0.01	-0.01	-0.01	-0.02	-0.02	

757 Flight Crew Operations Manual

**Flight With Unreliable Airspeed / Turbulent Air Penetration**  
Altitude and/or vertical speed indications may also be unreliable.

**Climb (290/.78)**

**Flaps Up, Set Max Climb Thrust**

PRESSURE ALTITUDE (FT)		WEIGHT (1000 LB)			
		140	180	220	260
40000	<b>PITCH ATT</b>	<b>4.5</b>	<b>4.5</b>		
	V/S (FT/MIN)	1800	900		
30000	<b>PITCH ATT</b>	<b>4.5</b>	<b>4.0</b>	<b>4.0</b>	<b>4.0</b>
	V/S (FT/MIN)	2500	1800	1300	800
20000	<b>PITCH ATT</b>	<b>7.0</b>	<b>6.5</b>	<b>6.0</b>	<b>6.0</b>
	V/S (FT/MIN)	3900	2900	2200	1600
10000	<b>PITCH ATT</b>	<b>10.0</b>	<b>8.5</b>	<b>8.0</b>	<b>7.5</b>
	V/S (FT/MIN)	5100	3800	3000	2300
SEA LEVEL	<b>PITCH ATT</b>	<b>13.5</b>	<b>11.0</b>	<b>10.0</b>	<b>9.5</b>
	V/S (FT/MIN)	6100	4600	3600	2900

**Cruise (.78/290)**

**Flaps Up, EPR for Level Flight**

PRESSURE ALTITUDE (FT)		WEIGHT (1000 LB)			
		140	180	220	260
40000	<b>PITCH ATT</b>	<b>2.5</b>	<b>3.0</b>		
	EPR	1.51	1.62		
	(Alt Mode %N1)	(83.6)	(88.4)		
35000	<b>PITCH ATT</b>	<b>1.5</b>	<b>2.5</b>	<b>3.0</b>	<b>3.5</b>
	EPR	1.45	1.50	1.59	1.71
	(Alt Mode %N1)	(81.1)	(83.6)	(87.3)	(93.6)
30000	<b>PITCH ATT</b>	<b>1.0</b>	<b>2.0</b>	<b>2.5</b>	<b>3.0</b>
	EPR	1.41	1.44	1.48	1.54
	(Alt Mode %N1)	(80.3)	(82.0)	(84.2)	(87.2)
25000	<b>PITCH ATT</b>	<b>1.5</b>	<b>2.0</b>	<b>2.5</b>	<b>3.5</b>
	EPR	1.34	1.37	1.40	1.45
	(Alt Mode %N1)	(76.6)	(78.2)	(80.3)	(82.9)
20000	<b>PITCH ATT</b>	<b>1.5</b>	<b>2.0</b>	<b>2.5</b>	<b>3.5</b>
	EPR	1.29	1.31	1.34	1.38
	(Alt Mode %N1)	(73.0)	(74.7)	(76.7)	(79.1)
15000	<b>PITCH ATT</b>	<b>1.5</b>	<b>2.0</b>	<b>3.0</b>	<b>3.5</b>
	EPR	1.24	1.26	1.28	1.32
	(Alt Mode %N1)	(69.6)	(71.3)	(73.3)	(75.7)

**Flight With Unreliable Airspeed / Turbulent Air Penetration**  
Altitude and/or vertical speed indications may also be unreliable.

Descent (.78/290)

Flaps Up, Set Idle Thrust

PRESSURE ALTITUDE (FT)		WEIGHT (1000 LB)			
		140	180	220	260
40000	<b>PITCH ATT</b>	<b>-1.0</b>	<b>0.0</b>		
	V/S (FT/MIN)	-2600	-2500		
30000	<b>PITCH ATT</b>	<b>-2.5</b>	<b>-1.5</b>	<b>-0.5</b>	<b>0.5</b>
	V/S (FT/MIN)	-3000	-2500	-2300	-2200
20000	<b>PITCH ATT</b>	<b>-2.5</b>	<b>-1.5</b>	<b>-0.5</b>	<b>0.5</b>
	V/S (FT/MIN)	-2800	-2300	-2100	-2000
10000	<b>PITCH ATT</b>	<b>-3.0</b>	<b>-1.5</b>	<b>-0.5</b>	<b>0.5</b>
	V/S (FT/MIN)	-2500	-2100	-1900	-1800
SEA LEVEL	<b>PITCH ATT</b>	<b>-3.0</b>	<b>-1.5</b>	<b>-0.5</b>	<b>0.5</b>
	V/S (FT/MIN)	-2300	-1900	-1700	-1600

Holding (VREF30 + 80)

Flaps Up, EPR for Level Flight

PRESSURE ALTITUDE (FT)		WEIGHT (1000 LB)			
		140	180	220	260
10000	<b>PITCH ATT</b>	<b>5.5</b>	<b>5.5</b>	<b>6.0</b>	<b>6.0</b>
	EPR	1.15	1.19	1.23	1.27
	(Alt Mode %N1)	(55.1)	(61.0)	(66.2)	(70.6)
	KIAS	188	205	220	235
5000	<b>PITCH ATT</b>	<b>5.5</b>	<b>6.0</b>	<b>6.0</b>	<b>6.5</b>
	EPR	1.13	1.16	1.19	1.23
	(Alt Mode %N1)	(51.5)	(57.3)	(62.1)	(66.5)
	KIAS	188	205	220	235

Terminal Area (5000 FT)

EPR for Level Flight

FLAP POSITION (VREF + INCREMENT)		WEIGHT (1000 LB)			
		140	180	220	260
FLAPS 1 (GEAR UP) (VREF30 + 60)	<b>PITCH ATT</b>	<b>6.5</b>	<b>7.0</b>	<b>7.5</b>	<b>8.0</b>
	EPR	1.14	1.18	1.22	1.25
	KIAS	169	185	201	216
	(Alt Mode %N1)	(52.5)	(58.5)	(64.3)	(68.5)
FLAPS 5 (GEAR UP) (VREF30 + 40)	<b>PITCH ATT</b>	<b>7.0</b>	<b>7.5</b>	<b>7.5</b>	<b>8.0</b>
	EPR	1.15	1.19	1.23	1.27
	KIAS	149	165	181	196
	(Alt Mode %N1)	(53.1)	(59.6)	(65.2)	(69.6)
FLAPS 15 (GEAR UP) (VREF30 + 20)	<b>PITCH ATT</b>	<b>8.0</b>	<b>8.0</b>	<b>8.0</b>	<b>7.5</b>
	EPR	1.17	1.21	1.26	1.30
	KIAS	128	145	161	176
	(Alt Mode %N1)	(55.6)	(62.5)	(67.7)	(72.5)
FLAPS 20 (GEAR UP) (VREF30 + 20)	<b>PITCH ATT</b>	<b>5.0</b>	<b>5.0</b>	<b>5.0</b>	<b>5.0</b>
	EPR	1.18	1.23	1.28	1.32
	KIAS	128	145	161	176
	(Alt Mode %N1)	(57.4)	(64.1)	(69.6)	(74.3)

757 Flight Crew Operations Manual

**Flight With Unreliable Airspeed / Turbulent Air Penetration**  
**Altitude and/or vertical speed indications may also be unreliable.**  
**Final Approach (1500 FT)**  
**Gear Down, EPR for 3° Glideslope**

FLAP POSITION (VREF + INCREMENT)		WEIGHT (1000 LB)			
		140	180	220	260
FLAPS 25 (VREF25 + 10)	<b>PITCH ATT</b>	<b>2.5</b>	<b>2.5</b>	<b>2.5</b>	<b>2.5</b>
	EPR	1.12	1.16	1.19	1.22
	KIAS	121	137	152	167
	(Alt Mode %N1)	(48.8)	(54.4)	(59.8)	(64.2)
FLAPS 30 (VREF30 + 10)	<b>PITCH ATT</b>	<b>1.0</b>	<b>1.0</b>	<b>0.5</b>	<b>0.5</b>
	EPR	1.15	1.19	1.23	1.27
	KIAS	118	135	151	165
	(Alt Mode %N1)	(52.7)	(59.5)	(64.8)	(69.5)



**Performance Inflight**  
**All Engine**

**Chapter PI**  
**Section 11**

**Long Range Cruise Maximum Operating Altitude**  
**ISA + 10°C and Below**

WEIGHT (1000 LB)	OPTIMUM ALT (FT)	TAT (°C)	MARGIN TO INITIAL BUFFET 'G' (BANK ANGLE)				
			1.20 (33°)	1.25 (36°)	1.30 (39°)	1.40 (44°)	1.50 (48°)
260	31100	-6	35600*	35500	34700	33100	31600
250	31900	-8	36400*	36300	35500	33900	32500
240	32800	-10	37200*	37200	36400	34800	33300
230	33700	-12	38100*	38100	37200	35700	34200
220	34700	-14	38900*	38900*	38200	36600	35200
210	35600	-17	39800*	39800*	39100	37600	36200
200	36600	-18	40800*	40800*	40200	38600	37200
190	37700	-18	41800*	41800*	41200	39700	38200
180	38800	-18	42000	42000	42000	40800	39400
170	40000	-18	42000	42000	42000	42000	40500
160	41300	-18	42000	42000	42000	42000	41800
150	42000	-18	42000	42000	42000	42000	42000
140	42000	-18	42000	42000	42000	42000	42000

**ISA + 15°C**

WEIGHT (1000 LB)	OPTIMUM ALT (FT)	TAT (°C)	MARGIN TO INITIAL BUFFET 'G' (BANK ANGLE)				
			1.20 (33°)	1.25 (36°)	1.30 (39°)	1.40 (44°)	1.50 (48°)
260	31100	-1	34800*	34800*	34700	33100	31600
250	31900	-3	35800*	35800*	35500	33900	32500
240	32800	-5	36700*	36700*	36400	34800	33300
230	33700	-7	37500*	37500*	37200	35700	34200
220	34700	-9	38300*	38300*	38200	36600	35200
210	35600	-11	39200*	39200*	39100	37600	36200
200	36600	-12	40100*	40100*	40100*	38600	37200
190	37700	-12	41100*	41100*	41100*	39700	38200
180	38800	-12	42000	42000	42000	40800	39400
170	40000	-12	42000	42000	42000	42000	40500
160	41300	-12	42000	42000	42000	42000	41800
150	42000	-12	42000	42000	42000	42000	42000
140	42000	-12	42000	42000	42000	42000	42000

**ISA + 20°C**

WEIGHT	OPTIMUM	TAT	MARGIN TO INITIAL BUFFET 'G' (BANK ANGLE)				
			1.20	1.25	1.30	1.40	1.50
260	31100	5	33500*	33500*	33500*	33100	31600
250	31900	3	34800*	34800*	34800*	33900	32500
240	32800	1	35900*	35900*	35900*	34800	33300
230	33700	-1	36800*	36800*	36800*	35700	34200
220	34700	-3	37600*	37600*	37600*	36600	35200
210	35600	-5	38500*	38500*	38500*	37600	36200
200	36600	-6	39400*	39400*	39400*	38600	37200
190	37700	-6	40400*	40400*	40400*	39700	38200
180	38800	-6	41400*	41400*	41400*	40800	39400
170	40000	-6	42000	42000	42000	42000	40500
160	41300	-6	42000	42000	42000	42000	41800
150	42000	-6	42000	42000	42000	42000	42000
140	42000	-6	42000	42000	42000	42000	42000

\*Denotes altitude thrust limited in level flight.

757 Flight Crew Operations Manual

**Long Range Cruise Control**

WEIGHT (1000 LB)		PRESSURE ALTITUDE (1000 FT)										
		21	23	25	27	29	31	33	35	37	39	41
260	EPR	1.40	1.43	1.46	1.49	1.53	1.58	1.64	1.72			
	MACH	.713	.737	.760	.781	.796	.799	.799	.797			
	KIAS	323	322	320	316	309	297	284	271			
	FF/ENG	5008	4970	4938	4892	4824	4757	4771	4940			
240	EPR	1.38	1.41	1.43	1.46	1.50	1.54	1.59	1.65	1.74		
	MACH	.695	.714	.738	.762	.783	.797	.799	.799	.796		
	KIAS	315	311	310	307	303	296	284	272	258		
	FF/ENG	4686	4603	4570	4539	4494	4429	4383	4408	4627		
220	EPR	1.36	1.38	1.41	1.44	1.47	1.50	1.55	1.60	1.66		
	MACH	.674	.695	.714	.739	.763	.784	.797	.799	.799		
	KIAS	305	302	299	297	295	291	283	272	259		
	FF/ENG	4360	4281	4203	4174	4144	4102	4053	4011	4061		
200	EPR	1.33	1.36	1.38	1.41	1.44	1.47	1.51	1.55	1.60	1.67	
	MACH	.644	.671	.693	.712	.737	.762	.784	.797	.799	.799	
	KIAS	291	291	289	286	284	282	278	271	259	248	
	FF/ENG	3969	3952	3884	3810	3781	3754	3729	3682	3660	3730	
180	EPR	1.31	1.33	1.36	1.38	1.41	1.43	1.47	1.50	1.55	1.60	1.66
	MACH	.616	.637	.665	.689	.709	.733	.759	.781	.796	.799	.799
	KIAS	277	276	277	276	272	270	268	265	258	248	236
	FF/ENG	3709	3557	3546	3497	3473	3391	3382	3358	3333	3331	3386
160	EPR	1.29	1.30	1.32	1.35	1.38	1.40	1.43	1.46	1.50	1.54	1.59
	MACH	.592	.609	.628	.656	.683	.702	.725	.752	.776	.794	.799
	KIAS	266	263	261	262	262	258	256	254	251	246	236
	FF/ENG	3379	3352	3297	3188	3159	3045	3016	3011	3051	3055	3050
140	EPR	1.26	1.28	1.30	1.32	1.34	1.37	1.39	1.42	1.45	1.49	1.53
	MACH	.558	.581	.599	.618	.642	.671	.694	.715	.742	.767	.789
	KIAS	250	250	248	245	245	245	243	240	239	237	233
	FF/ENG	3045	3011	2952	2893	2778	2764	2728	2687	2694	2710	2717
120	EPR	1.23	1.25	1.26	1.28	1.30	1.33	1.35	1.38	1.41	1.44	1.47
	MACH	.521	.540	.563	.586	.604	.624	.651	.680	.701	.725	.753
	KIAS	233	232	232	232	229	227	228	228	225	222	221
	FF/ENG	2660	2617	2591	2559	2501	2453	2379	2370	2338	2341	2362

Shaded area approximates optimum altitude.

**Long Range Cruise Enroute Fuel and Time - Low Altitudes**  
**Ground to Air Miles Conversion**

AIR DISTANCE (NM)					GROUND DISTANCE (NM)	AIR DISTANCE (NM)				
HEADWIND COMPONENT (KTS)						TAILWIND COMPONENT (KTS)				
100	80	60	40	20		20	40	60	80	100
285	263	244	227	213	200	191	182	174	167	160
570	526	488	454	426	400	382	365	349	335	322
855	790	731	682	639	600	573	548	525	503	484
1142	1054	976	910	852	800	763	730	699	671	646
1430	1320	1222	1138	1065	1000	955	913	874	839	807
1720	1586	1467	1366	1278	1200	1146	1096	1049	1007	968
2011	1853	1713	1595	1492	1400	1336	1278	1224	1174	1130
2303	2122	1961	1824	1706	1600	1528	1461	1399	1342	1291
2597	2391	2209	2054	1920	1800	1718	1643	1573	1509	1451

**Reference Fuel And Time Required at Check Point**

AIR DIST (NM)	PRESSURE ALTITUDE (1000 FT)									
	10		14		18		22		28	
	FUEL (1000 LB)	TIME (HR:MIN)	FUEL (1000 LB)	TIME (HR:MIN)	FUEL (1000 LB)	TIME (HR:MIN)	FUEL (1000 LB)	TIME (HR:MIN)	FUEL (1000 LB)	TIME (HR:MIN)
200	4.6	0:40	4.1	0:39	3.7	0:38	3.2	0:37	2.7	0:35
400	9.5	1:16	8.6	1:13	8.1	1:10	7.1	1:07	6.2	1:04
600	14.3	1:52	13.1	1:46	12.4	1:42	11.0	1:38	9.6	1:32
800	19.1	2:28	17.5	2:21	16.6	2:15	14.9	2:08	13.1	2:00
1000	23.8	3:05	21.9	2:55	20.8	2:47	18.7	2:40	16.5	2:29
1200	28.4	3:42	26.2	3:31	25.0	3:20	22.6	3:11	19.8	2:58
1400	33.0	4:20	30.5	4:06	29.1	3:54	26.5	3:43	23.2	3:26
1600	37.6	4:58	34.7	4:42	33.2	4:27	30.2	4:15	26.5	3:56
1800	42.1	5:36	38.9	5:18	37.2	5:01	34.0	4:47	29.8	4:25

**Fuel Required Adjustment (1000 LB)**

REFERENCE FUEL REQUIRED (1000 LB)	WEIGHT AT CHECK POINT (1000 LB)					
	160	180	200	220	240	260
5	-0.3	-0.2	0.0	0.2	0.4	0.6
10	-0.8	-0.3	0.0	0.5	1.0	1.5
15	-1.2	-0.5	0.0	0.8	1.6	2.4
20	-1.7	-0.7	0.0	1.0	2.1	3.2
25	-2.1	-1.0	0.0	1.3	2.6	4.0
30	-2.3	-1.2	0.0	1.5	3.1	4.8
35	-2.5	-1.4	0.0	1.7	3.6	5.6
40	-2.5	-1.7	0.0	1.9	4.1	6.3
45	-2.5	-2.0	0.0	2.0	4.5	7.0
50	-2.4	-2.2	0.0	2.2	5.0	7.7

757 Flight Crew Operations Manual

**Long Range Cruise Enroute Fuel and Time - High Altitudes  
Ground to Air Miles Conversion**

AIR DISTANCE (NM)					GROUND DISTANCE (NM)	AIR DISTANCE (NM)					
HEADWIND COMPONENT (KTS)						TAILWIND COMPONENT (KTS)	20	40	60	80	100
100	80	60	40	20							
659	620	584	553	525	500	479	458	440	423	407	
1312	1236	1167	1106	1051	1000	958	919	882	849	818	
1968	1854	1750	1658	1576	1500	1437	1378	1323	1273	1228	
2627	2474	2335	2212	2101	2000	1916	1838	1766	1699	1638	
3290	3097	2922	2767	2628	2500	2395	2297	2207	2123	2047	
3956	3723	3510	3322	3154	3000	2874	2756	2648	2548	2456	
4627	4351	4101	3880	3681	3500	3352	3215	3088	2970	2863	
5304	4985	4695	4439	4210	4000	3830	3672	3526	3392	3270	

**Reference Fuel And Time Required at Check Point**

AIR DIST (NM)	PRESSURE ALTITUDE (1000 FT)									
	29		31		33		35		37	
	FUEL (1000 LB)	TIME (HR:MIN)	FUEL (1000 LB)	TIME (HR:MIN)	FUEL (1000 LB)	TIME (HR:MIN)	FUEL (1000 LB)	TIME (HR:MIN)	FUEL (1000 LB)	TIME (HR:MIN)
500	7.7	1:17	7.4	1:15	7.2	1:14	7.0	1:14	6.9	1:14
1000	16.1	2:27	15.6	2:24	15.1	2:21	14.7	2:19	14.5	2:19
1500	24.4	3:39	23.5	3:33	22.9	3:29	22.3	3:26	21.9	3:25
2000	32.5	4:51	31.3	4:44	30.4	4:38	29.6	4:33	29.1	4:31
2500	40.5	6:05	38.8	5:56	37.8	5:47	36.8	5:41	36.1	5:37
3000	48.2	7:20	46.2	7:09	44.9	6:59	43.8	6:50	43.0	6:44
3500	55.8	8:36	53.4	8:23	52.0	8:11	50.7	8:00	49.7	7:52
4000	63.2	9:55	60.5	9:38	58.9	9:24	57.4	9:12	56.3	9:01

**Fuel Required Adjustment (1000 LB)**

REFERENCE FUEL REQUIRED (1000 LB)	WEIGHT AT CHECK POINT (1000 LB)					
	160	180	200	220	240	260
10	-0.8	-0.3	0.0	0.9	2.1	4.2
20	-1.8	-0.8	0.0	1.8	4.1	7.6
30	-2.8	-1.3	0.0	2.6	5.9	10.6
40	-3.8	-1.8	0.0	3.2	7.4	13.0
50	-4.7	-2.3	0.0	3.8	8.6	15.0
60	-5.6	-2.8	0.0	4.2	9.6	16.4
70	-6.5	-3.2	0.0	4.5	10.3	17.3

### Long Range Cruise Wind-Altitude Trade

PRESSURE ALTITUDE (1000 FT)	CRUISE WEIGHT (1000 LB)											
	250	240	230	220	210	200	190	180	170	160	150	140
41								8	2	0	2	7
39						10	3	0	0	4	10	19
37				10	4	0	0	2	7	14	24	35
35		8	3	0	0	2	5	11	19	29	40	53
33	2	0	0	2	5	10	17	25	35	46	58	72
31	0	2	5	10	16	23	31	41	52	64	76	90
29	6	10	16	22	30	38	48	58	70	82	95	108
27	16	23	29	37	46	55	65	76	88	100	112	126
25	30	37	45	54	63	73	83	94	105	117	129	
23	46	54	62	71	80	90	100	111	122	133		

The above wind factor table is for calculation of wind required to maintain present range capability at new pressure altitude, i.e., break-even wind.

Method:

1. Read wind factors for present and new altitudes from table.
2. Determine difference (new altitude wind factor minus present altitude wind factor); this difference may be negative or positive.
3. Break-even wind at new altitude is present altitude wind plus difference from step 2.

### Descent at .78/290/250

PRESSURE ALT (1000 FT)	15	17	19	21	23	25	27	29	31	33	35	37	39	41
DISTANCE (NM)	50	56	62	68	74	80	86	92	99	103	108	113	119	125
TIME (MINUTES)	13	14	15	16	17	17	18	19	20	20	21	22	22	23

### Holding Flaps Up

	WEIGHT (1000 LB)	PRESSURE ALTITUDE (FT)								
		1500	5000	10000	15000	20000	25000	30000	35000	40000
260	EPR	1.20	1.23	1.27	1.33	1.40				
	KIAS	235	235	235	235	235				
	FF/ENG	4700	4650	4570	4510	4440				
240	EPR	1.19	1.21	1.25	1.30	1.37	1.45			
	KIAS	228	228	228	228	228	228			
	FF/ENG	4350	4300	4230	4160	4100	4060			
220	EPR	1.17	1.19	1.23	1.28	1.34	1.41			
	KIAS	220	220	220	220	220	220			
	FF/ENG	4340	3950	3880	3820	3880	3710			
200	EPR	1.16	1.18	1.21	1.26	1.31	1.38	1.46		
	KIAS	213	213	213	213	213	213	213		
	FF/ENG	3990	3910	3540	3480	3540	3420	3390		
180	EPR	1.14	1.16	1.19	1.23	1.28	1.34	1.42	1.52	
	KIAS	205	205	205	205	205	205	205	205	
	FF/ENG	3630	3560	3210	3190	3250	3090	3040	3080	
160	EPR	1.13	1.15	1.17	1.21	1.25	1.31	1.38	1.47	1.58
	KIAS	197	197	197	197	197	197	197	197	197
	FF/ENG	3330	3260	3160	2860	2920	2850	2710	2710	2870
140	EPR	1.11	1.13	1.15	1.19	1.22	1.27	1.33	1.41	1.51
	KIAS	188	188	188	188	188	188	188	188	188
	FF/ENG	2970	2910	2820	2530	2590	2530	2470	2370	2450

This table includes 5% additional fuel for holding in a racetrack pattern.

Intentionally  
Blank

**Performance Inflight**  
**Advisory Information**

**Chapter PI**  
**Section 12**

**ADVISORY INFORMATION**

**Normal Configuration Landing Distance**

**Flaps 30**

**Dry Runway**

BRAKING CONFIGURATION	LANDING DISTANCE AND ADJUSTMENTS (FT)											
	REF DIST	WT ADJ	ALT ADJ	WIND ADJ PER 10 KTS		SLOPE ADJ PER 1%		TEMP ADJ PER 10°C		VREF ADJ	REVERSE THRUST ADJ	
	190000 LB LANDING WEIGHT	PER 10000 LB ABOVE/BELOW 190000 LB	PER 1000 FT STD/ HIGH*	HEAD WIND	TAIL WIND	DOWN HILL	UP HILL	ABV ISA	BLW ISA	PER 10 KTS ABOVE VREF30	ONE REV	NO REV
MAX MANUAL	2670	+100/-90	60/70	-110	380	40	-30	50	-50	220	50	100
MAX AUTO	4060	+160/-160	90/120	-180	580	50	-50	90	-90	310	130	260
AUTOBRAKE 4	4390	+190/-180	110/140	-210	680	60	-60	100	-100	360	140	290
AUTOBRAKE 3	4970	+240/-230	130/170	-260	850	70	-70	130	-130	450	160	330
AUTOBRAKE 2	5500	+290/-280	160/210	-300	1010	120	-130	150	-150	460	270	450
AUTOBRAKE 1	5910	+330/-330	190/250	-350	1170	200	-210	160	-160	460	600	900

**Good Reported Braking Action**

MAX MANUAL	3510	+160/-140	90/120	-170	610	80	-70	80	-80	290	180	430
MAX AUTO	4250	+180/-180	100/140	-200	690	100	-90	90	-90	310	310	730
AUTOBRAKE 4	4430	+190/-190	110/140	-220	730	80	-70	100	-100	360	180	530
AUTOBRAKE 3	4970	+240/-230	130/170	-260	850	80	-70	130	-130	450	160	330

**Medium Reported Braking Action**

MAX MANUAL	4610	+230/-210	130/180	-260	980	190	-150	110	-110	370	520	1350
MAX AUTO	4940	+250/-240	140/190	-290	1020	200	-170	120	-120	360	650	1680
AUTOBRAKE 4	4950	+250/-240	140/190	-290	1020	200	-170	120	-120	360	640	1670
AUTOBRAKE 3	5170	+260/-240	140/190	-300	1050	160	-120	130	-130	450	450	1430

**Poor Reported Braking Action**

MAX MANUAL	5750	+320/-280	180/250	-380	1500	420	-280	140	-140	420	1080	3250
MAX AUTO	5810	+330/-300	190/260	-380	1510	420	-310	140	-150	410	1180	3540
AUTOBRAKE 4	5820	+330/-300	190/260	-380	1510	420	-310	140	-150	410	1180	3540
AUTOBRAKE 3	5840	+330/-300	190/260	-380	1520	410	-290	140	-150	450	1160	3510

Reference distance is for sea level, standard day, no wind or slope, VREF30 approach speed and 2 engine reverse thrust.

Max Manual braking data valid for auto speedbrakes. For manual speedbrakes, increase reference landing distance by 280 ft.

Autobrake data valid for both auto and manual speedbrakes.

Actual (unfactored) distances are shown.

Includes distance from 50 ft above threshold (1000 ft of air distance).

\*For landing distance at or below 8000 ft pressure altitude, apply the STD adjustment. For altitudes higher than 8000 ft, first apply the STD adjustment to derive a new reference landing distance for 8000 ft, then apply the HIGH adjustment to this new reference distance.

**ADVISORY INFORMATION**

**Normal Configuration Landing Distance**

**Flaps 25**

**Dry Runway**

BRAKING CONFIGURATION	LANDING DISTANCE AND ADJUSTMENTS (FT)											
	REF DIST	WT ADJ	ALT ADJ	WIND ADJ PER 10 KTS		SLOPE ADJ PER 1%		TEMP ADJ PER 10°C		VREF ADJ	REVERSE THRUST ADJ	
	190000 LB LANDING WEIGHT	PER 10000 LB ABOVE/BELOW 190000 LB	PER 1000 FT STD/HIGH*	HEAD WIND	TAIL WIND	DOWN HILL	UP HILL	ABV ISA	BLW ISA	PER 10 KTS ABOVE VREF25	ONE REV	NO REV
MAX MANUAL	2710	+110/-90	60/70	-110	380	40	-30	50	-50	220	50	110
MAX AUTO	4200	+160/-160	90/120	-180	590	60	-50	90	-90	320	140	280
AUTOBRAKE 4	4550	+190/-190	110/140	-210	690	60	-60	110	-110	380	150	300
AUTOBRAKE 3	5180	+240/-230	140/180	-260	870	80	-80	140	-140	480	170	340
AUTOBRAKE 2	5760	+290/-280	170/220	-310	1040	120	-130	160	-160	490	260	460
AUTOBRAKE 1	6210	+340/-340	200/260	-360	1210	210	-220	170	-170	490	630	920

**Good Reported Braking Action**

MAX MANUAL	3590	+150/-140	90/120	-170	610	90	-70	80	-80	300	190	450
MAX AUTO	4390	+180/-180	110/140	-210	710	110	-100	100	-100	320	330	780
AUTOBRAKE 4	4600	+190/-190	110/150	-220	740	80	-70	110	-110	380	190	560
AUTOBRAKE 3	5180	+240/-230	140/180	-260	870	80	-80	140	-140	480	170	350

**Medium Reported Braking Action**

MAX MANUAL	4770	+240/-210	140/190	-270	990	200	-160	110	-120	380	550	1460
MAX AUTO	5140	+250/-240	150/200	-300	1040	210	-180	120	-130	380	700	1830
AUTOBRAKE 4	5150	+250/-240	150/200	-300	1040	210	-180	120	-130	380	690	1810
AUTOBRAKE 3	5380	+260/-240	150/200	-310	1080	170	-120	140	-140	480	490	1560

**Poor Reported Braking Action**

MAX MANUAL	6000	+330/-290	190/270	-390	1530	440	-300	150	-150	440	1180	3600
MAX AUTO	6080	+340/-320	200/280	-390	1550	440	-330	150	-150	430	1300	3920
AUTOBRAKE 4	6080	+340/-320	200/280	-390	1550	440	-330	150	-150	430	1290	3920
AUTOBRAKE 3	6100	+330/-310	200/270	-390	1550	430	-310	150	-160	480	1270	3900

Reference distance is for sea level, standard day, no wind or slope, VREF25 approach speed and 2 engine reverse thrust.

Max Manual braking data valid for auto speedbrakes. For manual speedbrakes, increase reference landing distance by 290 ft.

Autobrake data valid for both auto and manual speedbrakes.

Actual (unfactored) distances are shown.

Includes distance from 50 ft above threshold (1000 ft of air distance).

\*For landing distance at or below 8000 ft pressure altitude, apply the STD adjustment. For altitudes higher than 8000 ft, first apply the STD adjustment to derive a new reference landing distance for 8000 ft, then apply the HIGH adjustment to this new reference distance.



**ADVISORY INFORMATION**

**Non-Normal Configuration Landing Distance  
Dry Runway**

LANDING CONFIGURATION	VREF	LANDING DISTANCE AND ADJUSTMENTS (FT)							
		REFERENCE DISTANCE* FOR 190000 LB LANDING WEIGHT	WT ADJ PER 5000 LB ABOVE/BELOW 190000 LB	ALTITUDE ADJ PER 1000 FT STD/HIGH ***	WIND ADJ PER 10 KTS		SLOPE ADJ PER 1%		APPROACH SPEED
					HEAD WIND	TAIL WIND	DOWN HILL	UP HILL	PER 10 KTS ABOVE VREF
AIR-GROUND LOGIC IN AIR MODE	VREF30	3540	70/-60	75/105	-150	530	75	-65	400
ANTI-SKID SYSTEM INOP	VREF30	4120	90/-80	100/130	-200	745	100	-85	335
FLAPS UP	VREF30+50	3720	175/-60	105/165	-160	615	60	-55	305
HYDRAULIC SYSTEM CENTER INOP	VREF30	2750	55/-45	60/75	-110	400	40	-35	240
HYDRAULIC SYSTEM LEFT INOP	VREF30	3210	65/-55	70/90	-130	465	50	-45	310
HYDRAULIC SYSTEM LEFT INOP WITH LE SLAT OR TE FLAPS DISAGREE FOR FLAPS ≥ 20	VREF20	3490	65/-60	75/105	-140	485	55	-45	310
HYDRAULIC SYSTEM RIGHT INOP	VREF30	3250	70/-60	75/105	-140	505	70	-60	355
HYDRAULIC SYSTEMS CENTER AND LEFT INOP FLAPS 20	VREF30+20	3910	75/-65	90/120	-150	525	70	-60	365
HYDRAULIC SYSTEMS CENTER AND RIGHT INOP FLAPS 20	VREF30+20	4050	85/-75	105/140	-165	580	100	-85	430
HYDRAULIC SYSTEM** LEFT & RIGHT INOP FLAPS 20	VREF30+20	5250	110/-95	140/185	-220	750	375	-280	690

\* Reference distance assumes sea level, standard day with no wind or slope.

\*\* Reserve Brake System only.

Assumes maximum manual braking and maximum reverse thrust when available on operating engine(s). Actual (unfactored) distances are shown.

Includes distance from 50 ft above threshold (1000 ft of air distance).

\*\*\* For landing distance at or below 8000 ft pressure altitude, apply the STD adjustment. For altitudes higher than 8000 ft, first apply the STD adjustment to derive a new reference landing distance for 8000 ft, then apply HIGH adjustment to this new reference distance.

**ADVISORY INFORMATION**

**Non-Normal Configuration Landing Distance  
Dry Runway**

LANDING CONFIGURATION	VREF	LANDING DISTANCE AND ADJUSTMENTS (FT)							
		REFERENCE DISTANCE* FOR 190000 LB LANDING WEIGHT	WT ADJ PER 5000 LB ABOVE/ BELOW 190000 LB	ALTITUDE ADJ PER 1000 FT STD/HIGH ***	WIND ADJ PER 10 KTS		SLOPE ADJ PER 1%		APPROACH SPEED
					HEAD WIND	TAIL WIND	DOWN HILL	UP HILL	
LE SLAT ASYMMETRY FLAPS>20	VREF20	2890	70/-50	60/80	-110	400	40	-40	220
LE SLAT ASYMMETRY FLAPS = 20	VREF30+30	3350	100/-50	80/110	-130	440	50	-40	240
LE SLAT ASYMMETRY 5 ≤ FLAPS < 20	VREF30+40	3600	140/-60	90/130	-130	460	50	-50	240
LE SLAT DISAGREE	VREF20	2890	70/-50	65/85	-115	440	40	-35	230
ONE ENGINE INOP	VREF20	2940	75/-50	65/85	-120	455	45	-40	240
REVERSER UNLOCK FLAPS 20	VREF30+30	3390	105/-55	80/105	-140	515	55	-50	275
TRAILING EDGE FLAP ASYMMETRY FLAPS ≥ 20	VREF20	2890	70/-50	65/85	-115	440	40	-35	230
TRAILING EDGE ASYMMETRY 5<FLAPS<20	VREF30+30	3300	125/-55	75/105	-140	510	50	-45	260
TRAILING EDGE ASYMMETRY FLAPS ≤ 5	VREF30+40	3510	145/-55	85/125	-145	545	55	-50	275
TRAILING EDGE FLAP DISAGREE	VREF20	2890	70/-50	65/85	-115	440	40	-35	230

\* Reference distance assumes sea level, standard day with no wind or slope.

Assumes maximum manual braking and maximum reverse thrust when available on operating engine(s).

Actual (unfactored) distances are shown.

Includes distance from 50 ft above threshold (1000 ft of air distance).

\*\*\* For landing distance at or below 8000 ft pressure altitude, apply the STD adjustment. For altitudes higher than 8000 ft, first apply the STD adjustment to derive a new reference landing distance for 8000 ft, then apply HIGH adjustment to this new reference distance.

**ADVISORY INFORMATION**

**Non-Normal Configuration Landing Distance  
Good Reported Braking Action**

LANDING CONFIGURATION	VREF	LANDING DISTANCE AND ADJUSTMENTS (FT)							
		REFERENCE DISTANCE* FOR 190000 LB LANDING WEIGHT	WT ADJ PER 5000 LB ABOVE/BELOW 190000 LB	ALTITUDE ADJ PER 1000 FT STD/HIGH ***	WIND ADJ PER 10 KTS		SLOPE ADJ PER 1%		APPROACH SPEED
					HEAD WIND	TAIL WIND	DOWN HILL	UP HILL	PER 10 KTS ABOVE VREF
AIR-GROUND LOGIC IN AIR MODE	VREF30	5140	110/-95	130/165	-265	950	245	-185	590
ANTI-SKID SYSTEM INOP	VREF30	4980	120/-105	135/180	-280	1070	195	-155	390
FLAPS UP	VREF30+50	5140	105/-95	145/205	-215	770	125	-105	305
HYDRAULIC SYSTEM CENTER INOP	VREF30	3610	85/-70	90/120	-175	645	95	-80	315
HYDRAULIC SYSTEM LEFT INOP	VREF30	4260	95/-85	110/140	-205	750	130	-105	415
HYDRAULIC SYSTEM LEFT INOP WITH LE SLAT OR TE FLAPS DISAGREE FOR FLAPS ≥ 20	VREF20	4720	95/-95	125/170	-220	790	145	-120	430
HYDRAULIC SYSTEM RIGHT INOP	VREF30	4150	100/-85	110/150	-205	745	145	-120	445
HYDRAULIC SYSTEMS CENTER AND LEFT INOP FLAPS 20	VREF30+20	5330	115/-105	145/200	-240	855	180	-145	490
HYDRAULIC SYSTEMS CENTER AND RIGHT INOP FLAPS 20	VREF30+20	5270	120/-105	150/210	-245	855	205	-165	535
HYDRAULIC SYSTEM** LEFT & RIGHT INOP FLAPS 20	VREF30+20	6750	145/-130	195/265	-310	1060	1320	-780	865

\* Reference distance assumes sea level, standard day with no wind or slope.

\*\* Reserve Brake System only.

Assumes maximum manual braking and maximum reverse thrust when available on operating engine(s).

Actual (unfactored) distances are shown.

Includes distance from 50 ft above threshold (1000 ft of air distance).

\*\*\* For landing distance at or below 8000 ft pressure altitude, apply the STD adjustment. For altitudes higher than 8000 ft, first apply the STD adjustment to derive a new reference landing distance for 8000 ft, then apply HIGH adjustment to this new reference distance.

**ADVISORY INFORMATION**

**Non-Normal Configuration Landing Distance  
Good Reported Braking Action**

LANDING CONFIGURATION	VREF	LANDING DISTANCE AND ADJUSTMENTS (FT)							
		REFERENCE DISTANCE* FOR 190000 LB LANDING WEIGHT	WT ADJ PER 5000 LB ABOVE/BELOW 190000 LB	ALTITUDE ADJ PER 1000 FT STD/HIGH ***	WIND ADJ PER 10 KTS		SLOPE ADJ PER 1%		APPROACH SPEED
					HEAD WIND	TAIL WIND	DOWN HILL	UP HILL	
LE SLAT ASYMMETRY FLAPS>20	VREF20	3880	80/-80	100/140	-180	650	100	-80	300
LE SLAT ASYMMETRY FLAPS = 20	VREF30+30	4500	90/-90	120/170	-200	700	110	-100	320
LE SLAT ASYMMETRY 5 ≤ FLAPS < 20	VREF30+40	4930	100/-90	140/200	-210	740	120	-110	330
LE SLAT DISAGREE	VREF20	3880	115/-105	100/140	-240	855	180	-145	490
ONE ENGINE INOP	VREF20	4070	85/-80	105/145	-195	705	120	-100	335
REVERSER UNLOCK FLAPS 20	VREF30+30	4700	95/-90	125/175	-215	760	135	-115	340
TRAILING EDGE FLAP ASYMMETRY FLAPS ≥ 20	VREF20	3880	80/-75	100/140	-185	670	100	-85	300
TRAILING EDGE ASYMMETRY 5<FLAPS<20	VREF30+30	4490	95/-85	120/170	-200	720	110	-95	305
TRAILING EDGE ASYMMETRY FLAPS ≤ 5	VREF30+40	4800	100/-90	135/180	-205	740	115	-100	305
TRAILING EDGE FLAP DISAGREE	VREF20	3880	80/-75	100/140	-185	670	100	-85	300

\* Reference distance assumes sea level, standard day with no wind or slope.  
Assumes maximum manual braking and maximum reverse thrust when available on operating engine(s).  
Actual (unfactored) distances are shown.  
Includes distance from 50 ft above threshold (1000 ft of air distance).

\*\*\* For landing distance at or below 8000 ft pressure altitude, apply the STD adjustment. For altitudes higher than 8000 ft, first apply the STD adjustment to derive a new reference landing distance for 8000 ft, then apply HIGH adjustment to this new reference distance.

**ADVISORY INFORMATION**

**Non-Normal Configuration Landing Distance  
Medium Reported Braking Action**

LANDING CONFIGURATION	VREF	LANDING DISTANCE AND ADJUSTMENTS (FT)							
		REFERENCE DISTANCE* FOR 190000 LB LANDING WEIGHT	WT ADJ PER 5000 LB ABOVE/BELOW 190000 LB	ALTITUDE ADJ PER 1000 FT STD/HIGH ***	WIND ADJ PER 10 KTS		SLOPE ADJ PER 1%		APPROACH SPEED
					HEAD WIND	TAIL WIND	DOWN HILL	UP HILL	PER 10 KTS ABOVE VREF
AIR-GROUND LOGIC IN AIR MODE	VREF30	8380	160/-120	225/300	-530	2000	1125	-620	830
ANTI-SKID SYSTEM INOP	VREF30	6170	160/-145	185/245	-400	1655	465	-300	445
FLAPS UP	VREF30+50	7070	160/-150	225/315	-340	1260	315	-240	405
HYDRAULIC SYSTEM CENTER INOP	VREF30	4760	125/-105	140/180	-270	1055	230	-170	390
HYDRAULIC SYSTEM LEFT INOP	VREF30	5810	145/-130	170/235	-335	1270	355	-250	525
HYDRAULIC SYSTEM LEFT INOP WITH LE SLAT OR TE FLAPS DISAGREE FOR FLAPS ≥ 20	VREF20	6600	155/-145	200/290	-365	1350	410	-290	565
HYDRAULIC SYSTEM RIGHT INOP	VREF30	5780	155/-135	180/245	-335	1275	395	-275	550
HYDRAULIC SYSTEMS CENTER AND LEFT INOP FLAPS 20	VREF30+20	7450	175/-160	235/330	-395	1450	495	-345	625
HYDRAULIC SYSTEMS CENTER AND RIGHT INOP FLAPS 20	VREF30+20	7520	185/-165	250/355	-400	1470	550	-385	675
HYDRAULIC SYSTEM** LEFT & RIGHT INOP FLAPS 20	VREF30+20	10640	235/-210	350/490	-555	1970	5660	-1995	1190

\* Reference distance assumes sea level, standard day with no wind or slope.

\*\* Reserve Brake System only.

Assumes maximum manual braking and maximum reverse thrust when available on operating engine(s). Actual (unfactored) distances are shown.

Includes distance from 50 ft above threshold (1000 ft of air distance).

\*\*\* For landing distance at or below 8000 ft pressure altitude, apply the STD adjustment. For altitudes higher than 8000 ft, first apply the STD adjustment to derive a new reference landing distance for 8000 ft, then apply HIGH adjustment to this new reference distance.

**ADVISORY INFORMATION**

**Non-Normal Configuration Landing Distance**

**Medium Reported Braking Action**

LANDING CONFIGURATION	VREF	LANDING DISTANCE AND ADJUSTMENTS (FT)							
		REFERENCE DISTANCE* FOR 190000 LB LANDING WEIGHT	WT ADJ PER 5000 LB ABOVE/BELOW 190000 LB	ALTITUDE ADJ PER 1000 FT STD/HIGH ***	WIND ADJ PER 10 KTS		SLOPE ADJ PER 1%		APPROACH SPEED
					HEAD WIND	TAIL WIND	DOWN HILL	UP HILL	
LE SLAT ASYMMETRY FLAPS>20	VREF20	5250	120/-120	160/230	-290	1070	240	-190	390
LE SLAT ASYMMETRY FLAPS = 20	VREF30+30	6040	140/-130	190/270	-320	1140	260	-210	390
LE SLAT ASYMMETRY 5 ≤ FLAPS < 20	VREF30+40	6740	160/-150	210/300	-340	1200	290	-240	420
LE SLAT DISAGREE	VREF20	5250	175/-160	155/225	-395	1450	495	-345	625
ONE ENGINE INOP	VREF20	5770	135/-130	170/235	-325	1215	335	-245	450
REVERSER UNLOCK FLAPS 20	VREF30+30	6620	155/-145	200/280	-350	1290	365	-270	445
TRAILING EDGE FLAP ASYMMETRY FLAPS ≥ 20	VREF20	5250	125/-115	155/225	-290	1110	255	-190	385
TRAILING EDGE ASYMMETRY 5<FLAPS<20	VREF30+30	6150	145/-130	190/270	-315	1190	285	-215	395
TRAILING EDGE ASYMMETRY FLAPS ≤ 5	VREF30+40	6550	150/-140	205/290	-325	1220	295	-225	395
TRAILING EDGE FLAP DISAGREE	VREF20	5250	125/-115	155/225	-290	1110	255	-190	385

\* Reference distance assumes sea level, standard day with no wind or slope.

Assumes maximum manual braking and maximum reverse thrust when available on operating engine(s). Actual (unfactored) distances are shown.

Includes distance from 50 ft above threshold (1000 ft of air distance).

\*\*\* For landing distance at or below 8000 ft pressure altitude, apply the STD adjustment. For altitudes higher than 8000 ft, first apply the STD adjustment to derive a new reference landing distance for 8000 ft, then apply HIGH adjustment to this new reference distance.

**ADVISORY INFORMATION**

**Non-Normal Configuration Landing Distance  
Poor Reported Braking Action**

LANDING CONFIGURATION	VREF	LANDING DISTANCE AND ADJUSTMENTS (FT)							
		REFERENCE DISTANCE* FOR 190000 LB LANDING WEIGHT	WT ADJ PER 5000 LB ABOVE/BELOW 190000 LB	ALTITUDE ADJ PER 1000 FT STD/HIGH ***	WIND ADJ PER 10 KTS		SLOPE ADJ PER 1%		APPROACH SPEED
					HEAD WIND	TAIL WIND	DOWN HILL	UP HILL	PER 10 KTS ABOVE VREF
AIR-GROUND LOGIC IN AIR MODE	VREF30	> 15000	-	-	-	-	-	-	-
ANTI-SKID SYSTEM INOP	VREF30	8090	230/-205	260/350	-660	3115	3435	-690	490
FLAPS UP	VREF30+50	9150	230/-210	315/470	-505	1965	765	-470	480
HYDRAULIC SYSTEM CENTER INOP	VREF30	5980	165/-145	190/255	-400	1645	545	-320	435
HYDRAULIC SYSTEM LEFT INOP	VREF30	7710	205/-180	255/355	-525	2125	1035	-530	605
HYDRAULIC SYSTEM LEFT INOP WITH LE SLAT OR TE FLAPS DISAGREE FOR FLAPS ≥ 20	VREF20	8910	225/-210	305/475	-570	2265	1200	-620	675
HYDRAULIC SYSTEM RIGHT INOP	VREF30	7750	215/-185	270/370	-530	2145	1110	-565	630
HYDRAULIC SYSTEMS CENTER AND LEFT INOP FLAPS 20	VREF30+20	10050	255/-225	355/525	-625	2420	1430	-730	725
HYDRAULIC SYSTEMS CENTER AND RIGHT INOP FLAPS 20	VREF30+20	10250	270/-240	375/560	-635	2460	1555	-790	770
HYDRAULIC SYSTEM** LEFT & RIGHT INOP FLAPS 20	VREF30+20	> 15000	-	-	-	-	-	-	-

\* Reference distance assumes sea level, standard day with no wind or slope.

\*\* Reserve Brake System only.

Assumes maximum manual braking and maximum reverse thrust when available on operating engine(s). Actual (unfactored) distances are shown.

Includes distance from 50 ft above threshold (1000 ft of air distance).

\*\*\* For landing distance at or below 8000 ft pressure altitude, apply the STD adjustment. For altitudes higher than 8000 ft, first apply the STD adjustment to derive a new reference landing distance for 8000 ft, then apply HIGH adjustment to this new reference distance.

**ADVISORY INFORMATION**

**Non-Normal Configuration Landing Distance**

**Poor Reported Braking Action**

LANDING CONFIGURATION	VREF	LANDING DISTANCE AND ADJUSTMENTS (FT)							
		REFERENCE DISTANCE* FOR 190000 LB LANDING WEIGHT	WT ADJ PER 5000 LB ABOVE/BELOW 190000 LB	ALTITUDE ADJ PER 1000 FT STD/HIGH ***	WIND ADJ PER 10 KTS		SLOPE ADJ PER 1%		APPROACH SPEED
					HEAD WIND	TAIL WIND	DOWN HILL	UP HILL	
LE SLAT ASYMMETRY FLAPS>20	VREF20	6780	170/-160	220/330	-440	1690	570	-370	450
LE SLAT ASYMMETRY FLAPS = 20	VREF30+30	7690	200/-180	260/380	-460	1770	600	-400	450
LE SLAT ASYMMETRY 5 ≤ FLAPS < 20	VREF30+40	8680	220/-200	300/430	-500	1860	670	-450	490
LE SLAT DISAGREE	VREF20	6780	255/-225	220/330	-625	2420	1430	-730	725
ONE ENGINE INOP	VREF20	7830	200/-190	255/355	-505	1990	925	-515	545
REVERSER UNLOCK FLAPS 20	VREF30+30	8850	225/-205	290/410	-535	2080	975	-555	525
TRAILING EDGE FLAP ASYMMETRY FLAPS ≥ 20	VREF20	6780	175/-160	220/330	-435	1755	640	-375	450
TRAILING EDGE ASYMMETRY 5<FLAPS<20	VREF30+30	7960	205/-185	270/395	-475	1865	705	-420	465
TRAILING EDGE ASYMMETRY FLAPS ≤ 5	VREF30+40	8430	215/-195	290/420	-485	1900	720	-435	460
TRAILING EDGE FLAP DISAGREE	VREF20	6780	175/-160	220/330	-435	1755	640	-375	450

\* Reference distance assumes sea level, standard day with no wind or slope.

Assumes maximum manual braking and maximum reverse thrust when available on operating engine(s).

Actual (unfactored) distances are shown.

Includes distance from 50 ft above threshold (1000 ft of air distance).

\*\*\* For landing distance at or below 8000 ft pressure altitude, apply the STD adjustment. For altitudes higher than 8000 ft, first apply the STD adjustment to derive a new reference landing distance for 8000 ft, then apply HIGH adjustment to this new reference distance.



**ADVISORY INFORMATION**

**Recommended Brake Cooling Schedule  
Reference Brake Energy Per Brake (Millions of Foot Pounds)**

WEIGHT (1000 LB)		OAT (°F)		BRAKES ON SPEED (KIAS)																	
				80			100			120			140			160			180		
				PRESS ALT			PRESS ALT			PRESS ALT			PRESS ALT			PRESS ALT			PRESS ALT		
		0	5	10	0	5	10	0	5	10	0	5	10	0	5	10	0	5	10		
260	40	9.5	11.1	12.8	14.4	17.1	19.8	20.1	24.1	28.1	26.5	31.8	37.1	33.4	39.8		40.3				
	60	9.8	11.6	13.3	14.9	17.8	20.6	20.9	25.0	29.2	27.5	33.0	38.5	34.6	41.3		41.8				
	80	10.1	12.0	13.8	15.4	18.4	21.3	21.6	25.9	30.2	28.5	34.2	39.8	35.8	42.7		43.3				
	100	10.4	12.3	14.1	15.9	18.9	21.9	22.2	26.6	31.1	29.4	35.2	41.1	36.9	44.0		44.6				
	120	10.6	12.5	14.4	16.2	19.3	22.5	22.8	27.3	31.9	30.1	36.1	42.2	37.9	45.2		45.8				
240	40	8.8	10.4	12.0	13.4	15.9	18.4	18.7	22.3	26.0	24.6	29.5	34.4	31.0	37.0	43.1	37.5				
	60	9.2	10.8	12.4	13.9	16.5	19.1	19.4	23.2	27.0	25.5	30.6	35.7	32.4	38.4	44.7	39.0				
	80	9.5	11.1	12.8	14.4	17.1	19.8	20.0	24.0	27.9	26.4	31.7	37.0	33.2	39.7	46.2	40.3				
	100	9.7	11.4	13.2	14.8	17.5	20.3	20.6	24.7	28.8	27.2	32.7	38.1	34.3	41.0	47.6	41.5				
	120	9.9	11.7	13.4	15.1	17.9	20.8	21.1	25.3	29.5	27.9	33.5	39.1	35.2	42.1	49.0	42.7				
220	40	8.2	9.6	11.1	12.4	14.7	17.0	17.2	20.6	23.9	22.6	27.2	31.7	28.5	34.1	39.8	34.7	41.3			
	60	8.5	10.0	11.5	12.9	15.2	17.6	17.9	21.3	24.8	23.5	28.2	32.9	29.6	35.4	41.3	36.0	42.8			
	80	8.8	10.3	11.9	13.3	15.8	18.2	18.5	22.1	25.7	24.3	29.2	34.0	30.6	36.7	42.7	37.2	44.3			
	100	9.0	10.6	12.2	13.6	16.2	18.8	19.0	22.7	26.5	25.0	30.0	35.1	31.5	37.8	44.0	38.3	45.6			
	120	9.2	10.8	12.4	13.9	16.6	19.2	19.5	23.3	27.1	25.6	30.8	36.0	32.4	38.8	45.2	39.4	46.9			
200	40	7.6	8.9	10.2	11.4	13.5	15.6	15.8	18.8	21.8	20.6	24.8	28.9	26.0	31.2	36.4	31.6	37.8	43.9		
	60	7.9	9.2	10.6	11.8	14.0	16.2	16.4	19.5	22.7	21.4	25.7	30.0	27.0	32.3	37.7	32.8	39.2	45.6		
	80	8.1	9.5	10.9	12.2	14.5	16.7	16.9	20.2	23.4	22.2	26.6	31.0	27.9	33.5	39.0	34.0	40.5	47.1		
	100	8.3	9.8	11.2	12.5	14.9	17.2	17.4	20.8	24.1	22.8	27.4	31.9	28.7	34.5	40.2	35.0	41.8	48.6		
	120	8.5	9.9	11.4	12.8	15.2	17.6	17.8	21.3	24.7	23.4	28.1	32.8	29.5	35.4	41.3	35.9	42.9	50.0		
180	40	7.0	8.2	9.3	10.4	12.3	14.1	14.3	17.0	19.7	18.6	22.3	26.0	23.4	28.1	32.8	28.5	34.1	39.7		
	60	7.2	8.5	9.7	10.8	12.7	14.7	14.8	17.7	20.5	19.3	23.2	27.0	24.3	29.1	34.0	29.5	35.4	41.2		
	80	7.5	8.7	10.0	11.1	13.2	15.2	15.3	18.3	21.2	20.0	24.0	27.9	25.1	30.2	35.2	30.6	36.6	42.6		
	100	7.6	8.9	10.2	11.4	13.5	15.6	15.8	18.8	21.8	20.6	24.7	28.7	25.9	31.1	36.3	31.5	37.7	44.0		
	120	7.8	9.1	10.4	11.6	13.8	15.9	16.1	19.2	22.3	21.1	25.3	29.5	26.5	31.9	37.2	32.3	38.7	45.2		
160	40	6.4	7.4	8.4	9.4	11.0	12.7	12.8	15.2	17.6	16.6	19.8	23.1	20.7	24.9	29.0	25.2	30.2	35.2		
	60	6.6	7.7	8.8	9.7	11.5	13.2	13.3	15.8	18.3	17.2	20.6	23.9	21.5	25.8	30.1	26.1	31.3	36.6		
	80	6.8	7.9	9.1	10.0	11.8	13.6	13.7	16.3	18.9	17.8	21.3	24.8	22.3	26.7	31.2	27.0	32.4	37.8		
	100	6.9	8.1	9.3	10.3	12.2	14.0	14.1	16.8	19.4	18.3	21.9	25.5	22.9	27.5	32.1	27.8	33.4	39.0		
	120	7.0	8.2	9.4	10.5	12.4	14.3	14.4	17.2	19.9	18.8	22.5	26.1	23.5	28.2	32.9	28.5	34.3	40.0		
140	40	5.7	6.7	7.6	8.4	9.8	11.3	11.3	13.4	15.5	14.6	17.3	20.1	18.0	21.6	25.1	21.7	26.1	30.4		
	60	5.9	6.9	7.9	8.7	10.2	11.7	11.8	13.9	16.1	15.1	18.0	20.9	18.7	22.4	26.1	22.6	27.1	31.6		
	80	6.1	7.1	8.1	9.0	10.5	12.1	12.1	14.4	16.6	15.6	18.6	21.6	19.4	23.2	27.0	23.3	28.0	32.7		
	100	6.3	7.3	8.3	9.2	10.8	12.4	12.5	14.8	17.1	16.1	19.2	22.2	19.9	23.8	27.8	24.0	28.8	33.7		
	120	6.3	7.4	8.4	9.3	11.0	12.7	12.7	15.1	17.5	16.4	19.6	22.8	20.4	24.4	28.5	24.6	29.6	34.5		

\*To correct for wind, enter table with the brakes on speed minus one half the headwind or plus 1.5 times the tailwind. If ground speed is used for brakes on speed, ignore wind altitude, and OAT effects.

**ADVISORY INFORMATION**

**Recommended Brake Cooling Schedule  
Adjusted Brake Energy Per Brake (Millions of Foot Pounds)  
No Reverse Thrust**

EVENT		REFERENCE BRAKE ENERGY PER BRAKE (MILLIONS OF FOOT POUNDS)										
		10	12	14	16	18	20	22	24	26	28	30
RTO MAX MAN		10.0	12.0	14.0	16.0	18.0	20.0	22.0	24.0	26.0	28.0	30.0
LANDING	MAX MAN	8.6	10.5	12.4	14.3	16.2	18.1	20.0	22.0	23.9	25.8	27.7
	MAX AUTO	8.5	10.3	12.1	13.9	15.7	17.5	19.3	21.1	22.9	24.7	26.6
	AUTOBRAKE 4	8.4	10.2	11.9	13.6	15.3	17.0	18.7	20.4	22.1	23.8	25.6
	AUTOBRAKE 3	8.3	9.9	11.5	13.1	14.7	16.3	17.9	19.5	21.1	22.7	24.3
	AUTOBRAKE 2	8.1	9.6	11.1	12.6	14.1	15.5	17.0	18.5	19.9	21.4	22.8
AUTOBRAKE 1		7.9	9.3	10.7	12.0	13.3	14.6	15.9	17.2	18.5	19.8	21.1

**Two Engine Reverse**

EVENT		REFERENCE BRAKE ENERGY PER BRAKE (MILLIONS OF FOOT POUNDS)										
		10	12	14	16	18	20	22	24	26	28	30
RTO MAX MAN		10.0	12.0	14.0	16.0	18.0	20.0	22.0	24.0	26.0	28.0	30.0
LANDING	MAX MAN	7.6	9.2	10.9	12.6	14.4	16.1	17.9	19.7	21.4	23.2	24.8
	MAX AUTO	5.8	7.2	8.6	10.0	11.5	12.9	14.4	15.9	17.3	18.8	20.3
	AUTOBRAKE 4	4.5	5.7	6.8	8.0	9.1	10.3	11.5	12.7	14.0	15.2	16.5
	AUTOBRAKE 3	3.3	4.2	5.1	5.9	6.9	7.8	8.7	9.7	10.7	11.7	12.7
	AUTOBRAKE 2	2.3	2.9	3.5	4.1	4.8	5.5	6.2	6.9	7.6	8.3	9.0
AUTOBRAKE 1		1.7	2.1	2.4	2.8	3.2	3.6	4.0	4.5	4.9	5.4	5.9

**Cooling Time (Minutes)**

		ADJUSTED BRAKE ENERGY PER BRAKE (MILLIONS OF FOOT POUNDS)								
		8 & BELOW	9	10	12	14	16	17	18 TO 27	28 & ABOVE
INFLIGHT	NO SPECIAL	CAUTION	FUSE PLUG MELT ZONE	1	2	4	5	7	7	
GEAR DOWN	PROCEDURE			10	20	38	51	62	66	
GROUND	REQUIRED									
BTMS	UP TO 2									

Observe maximum quick turnaround limit.

Table shows energy per brake added by a single stop with all brakes operating. Energy is assumed to be equally distributed among the operating brakes. Total energy is the sum of residual energy plus energy added.

Add 0.65 million foot pounds per brake for each taxi mile.

For one brake deactivated, increase brake energy by 15 percent.

When in caution zone, wheel fuse plugs may melt. Delay takeoff and inspect after one hour. If overheat occurs after takeoff, extend gear soon for at least 8 minutes.

When in fuse plug melt zone, clear runway immediately. Unless required, do not set parking brake. Do not attempt to taxi for one hour. Tire, wheel and brake replacement may be required. If overheat occurs after takeoff, extend gear soon for at least 12 minutes.

Brake temperature monitor system (BTMS) indication on EICAS may be used to 10 to 15 minutes after airplane has come to a complete stop, or inflight with gear retracted, to determine recommended cooling schedule.

**Performance Inflight**  
**Engine Inoperative**

**Chapter PI**  
**Section 13**

**ENGINE INOP**

**Initial Max Continuous EPR**  
**Based on engine bleed for one pack on**

PRESSURE ALTITUDE (FT)		CRUISE MACH NUMBER		
		.72	.76	.80
41000	EPR	1.81	1.80	1.79
	MAX TAT (SAT)	-23 (-46)	-20 (-46)	-17 (-46)
	EPR CORR	0.04	0.04	0.04
39000	EPR	1.81	1.80	1.79
	MAX TAT (SAT)	-23 (-46)	-20 (-46)	-17 (-46)
	EPR CORR	0.04	0.04	0.04
37000	EPR	1.82	1.80	1.79
	MAX TAT (SAT)	-23 (-46)	-20 (-46)	-17 (-46)
	EPR CORR	0.04	0.04	0.04
35000	EPR	1.81	1.80	1.79
	MAX TAT (SAT)	-21 (-44)	-18 (-44)	-15 (-44)
	EPR CORR	0.05	0.05	0.05
33000	EPR	1.80	1.79	1.78
	MAX TAT (SAT)	-16 (-40)	-14 (-41)	-11 (-41)
	EPR CORR	0.05	0.05	0.05
31000	EPR	1.79	1.78	1.77
	MAX TAT (SAT)	-12 (-36)	-9 (-36)	-6 (-36)
	EPR CORR	0.05	0.05	0.05

Decrease EPR by the EPR CORR for every 10°C above the MAX TAT shown.

**ENGINE INOP**

**Max Continuous EPR**

**41000 FT to 22000 FT Pressure Altitudes**

**Based on engine bleed for one pack on and anti-ice off**

PRESSURE ALTITUDE (FT)		KIAS					MACH NUMBER					
		180	200	220	240	260	.70	.72	.74	.76	.78	.80
41000	EPR		1.82	1.81	1.79		1.82	1.81	1.81	1.80	1.80	1.79
	MAX TAT		-25	-21	-17		-24	-23	-22	-20	-19	-17
	EPR CORR		0.04	0.04	0.04		0.04	0.04	0.04	0.04	0.04	0.04
39000	EPR		1.83	1.82	1.80	1.78	1.82	1.81	1.81	1.80	1.80	-1.79
	MAX TAT		-27	-23	-19	-15	-24	-23	-22	-20	-19	-17
	EPR CORR		0.04	0.04	0.04	0.04	0.04	0.04	0.04	0.04	0.04	0.04
37000	EPR		1.84	1.82	1.81	1.79	1.82	1.82	1.81	1.80	1.80	1.79
	MAX TAT		-29	-25	-21	-17	-24	-23	-22	-20	-19	-17
	EPR CORR		0.04	0.04	0.04	0.04	0.04	0.04	0.04	0.04	0.04	0.04
35000	EPR		1.84	1.82	1.81	1.80	1.81	1.81	1.80	1.80	1.79	1.79
	MAX TAT		-28	-24	-21	-17	-22	-21	-19	-18	-16	-15
	EPR CORR		0.05	0.05	0.05	0.05	0.05	0.05	0.05	0.05	0.05	0.05
33000	EPR		1.83	1.82	1.81	1.80	1.81	1.80	1.79	1.78	1.78	1.78
	MAX TAT		-25	-22	-19	-15	-18	-16	-15	-14	-12	-11
	EPR CORR		0.05	0.05	0.05	0.05	0.05	0.05	0.05	0.05	0.05	0.05
31000	EPR		1.83	1.82	1.81	1.79	1.80	1.79	1.78	1.78	1.77	1.77
	MAX TAT		-22	-19	-16	-13	-13	-12	-10	-9	-8	-6
	EPR CORR		0.05	0.05	0.05	0.05	0.05	0.05	0.05	0.05	0.05	0.05
29000	EPR		1.82	1.81	1.80	1.79	1.79	1.78	1.77	1.77	1.76	1.75
	MAX TAT		-19	-16	-13	-10	-9	-7	-6	-5	-3	-2
	EPR CORR		0.05	0.05	0.05	0.05	0.05	0.05	0.05	0.05	0.05	0.05
27000	EPR		1.82	1.81	1.80	1.79	1.78	1.77	1.76	1.76	1.75	1.74
	MAX TAT		-16	-13	-11	-8	-5	-3	-2	0	1	3
	EPR CORR		0.05	0.05	0.05	0.05	0.05	0.05	0.05	0.05	0.05	0.05
25000	EPR	1.82	1.81	1.80	1.80	1.79	1.77	1.76	1.75	1.75	1.74	1.73
	MAX TAT	-15	-13	-10	-8	-5	0	1	3	4	6	7
	EPR CORR	0.06	0.06	0.06	0.06	0.06	0.06	0.06	0.06	0.06	0.06	0.06
22000	EPR	1.81	1.80	1.80	1.79	1.78	1.75	1.74	1.73	1.72	1.72	
	MAX TAT	-10	-8	-6	-3	-1	6	8	9	11	12	
	EPR CORR	0.06	0.06	0.06	0.06	0.06	0.06	0.06	0.06	0.06	0.06	

Decrease EPR by the EPR CORR for every 10°C above the MAX TAT shown.

**EPR Adjustments for Engine Bleed**

BLEED CONFIGURATION	PRESSURE ALTITUDE (1000 FT)				
	0	10	20	30	40
PACKS OFF	0.01	0.01	0.01	0.01	0.01
ENGINE ANTI-ICE ON	-0.01	-0.01	-0.01	-0.01	-0.02
ENGINE & WING ANTI-ICE ON	-0.03	-0.03	-0.03	-0.05	-0.08

**ENGINE INOP**

**Max Continuous EPR**

**20000 FT to Sea Level Pressure Altitudes**

**Based on engine bleed for one pack on and anti-ice off**

PRESSURE ALTITUDE (FT)		KIAS					MACH NUMBER					
		180	200	220	240	260	.70	.72	.74	.76	.78	.80
20000	EPR	1.80	1.80	1.79	1.78	1.77	1.73	1.72	1.71	1.71		
	MAX TAT	-6	-5	-3	0	2	11	12	14	15		
	EPR CORR	0.06	0.06	0.06	0.06	0.06	0.06	0.06	0.06	0.06		
18000	EPR	1.79	1.78	1.78	1.77	1.76	1.71	1.70	1.69			
	MAX TAT	-3	-1	1	3	5	15	17	18			
	EPR CORR	0.06	0.06	0.06	0.06	0.06	0.06	0.06	0.06			
16000	EPR	1.78	1.77	1.76	1.75	1.74	1.69					
	MAX TAT	0	2	4	6	8	19					
	EPR CORR	0.06	0.06	0.06	0.06	0.06	0.06					
14000	EPR	1.76	1.75	1.75	1.74	1.73						
	MAX TAT	4	6	7	9	11						
	EPR CORR	0.06	0.06	0.06	0.06	0.06						
12000	EPR	1.75	1.74	1.73	1.72	1.71						
	MAX TAT	8	9	11	12	14						
	EPR CORR	0.06	0.06	0.06	0.06	0.06						
10000	EPR	1.73	1.72	1.71	1.70	1.69						
	MAX TAT	11	13	14	16	17						
	EPR CORR	0.06	0.06	0.06	0.06	0.06						
5000	EPR	1.68	1.67	1.67	1.66	1.65						
	MAX TAT	20	21	23	24	26						
	EPR CORR	0.06	0.06	0.06	0.06	0.06						
1500	EPR	1.63	1.62	1.62	1.61	1.60						
	MAX TAT	27	28	29	30	32						
	EPR CORR	0.06	0.06	0.06	0.06	0.06						
0	EPR	1.61	1.60	1.60	1.59	1.58						
	MAX TAT	29	30	32	33	34						
	EPR CORR	0.06	0.06	0.06	0.06	0.06						

Decrease EPR by the EPR CORR for every 10°C above the MAX TAT shown.

**EPR Adjustments for Engine Bleed**

BLEED CONFIGURATION	PRESSURE ALTITUDE (1000 FT)				
	0	10	20	30	40
PACKS OFF	0.01	0.01	0.01	0.01	0.01
ENGINE ANTI-ICE ON	-0.01	-0.01	-0.01	-0.01	-0.02
ENGINE & WING ANTI-ICE ON	-0.03	-0.03	-0.03	-0.05	-0.08

**ENGINE INOP**

**MAX CONTINUOUS THRUST**

**Driftdown Speed/Level Off Altitude**

100 ft/min residual rate of climb

Includes APU fuel burn

WEIGHT (1000 LB)		OPTIMUM DRIFTDOWN SPEED (KIAS)	LEVEL OFF ALTITUDE (FT)		
START DRIFT DOWN	LEVEL OFF		ISA + 10°C & BELOW	ISA + 15°C	ISA + 20°C
260	250	254	19300	18100	16600
240	231	245	21700	20700	19400
220	212	235	24000	23100	22100
200	193	224	26500	25700	24800
180	174	213	29100	28400	27600
160	154	201	32000	31300	30600
140	135	189	35300	34500	33800

**Driftdown/LRC Cruise Range Capability**

Ground to Air Miles Conversion

AIR DISTANCE (NM)					GROUND DISTANCE (NM)	AIR DISTANCE (NM)				
HEADWIND COMPONENT (KTS)						TAILWIND COMPONENT (KTS)				
100	80	60	40	20	20	40	60	80	100	
278	258	240	225	212	200	189	180	171	163	156
557	516	481	451	424	400	379	360	342	327	312
831	771	720	675	635	600	568	540	514	491	470
1101	1024	957	898	846	800	758	721	687	656	628
1370	1276	1194	1121	1057	1000	949	902	860	822	787
1639	1527	1430	1344	1268	1200	1139	1084	1034	988	947
1908	1779	1666	1567	1479	1400	1329	1265	1207	1154	1106
2179	2032	1904	1790	1690	1600	1519	1446	1380	1319	1264
2454	2288	2143	2015	1901	1800	1709	1627	1552	1484	1421

**Driftdown/Cruise Fuel and Time**

AIR DIST (NM)	FUEL REQUIRED (1000 LB)						TIME (HR:MIN)
	WEIGHT AT START OF DRIFTDOWN (1000 LB)						
	160	180	200	220	240	260	
200	2.8	3.1	3.4	3.7	3.9	4.2	0:34
400	6.2	6.8	7.5	8.1	8.8	9.5	1:08
600	9.3	10.3	11.3	12.3	13.3	14.4	1:40
800	12.3	13.6	14.9	16.3	17.7	19.1	2:11
1000	15.2	16.9	18.6	20.3	22.0	23.8	2:42
1200	18.2	20.2	22.2	24.2	26.3	28.4	3:13
1400	21.0	23.4	25.7	28.1	30.5	33.0	3:44
1600	23.8	26.5	29.2	31.9	34.6	37.4	4:15
1800	26.6	29.6	32.6	35.6	38.7	41.9	4:48

Includes APU fuel burn.

Driftdown at optimum driftdown speed and cruise at Long Range Cruise speed.

**ENGINE INOP**

**MAX CONTINUOUS THRUST**

**Long Range Cruise Altitude Capability**

**100 ft/min residual rate of climb**

WEIGHT (1000 LB)	PRESSURE ALTITUDE (FT)		
	ISA + 10°C & BELOW	ISA + 15°C	ISA + 20°C
260	14600	11500	8300
250	16300	13700	10300
240	17900	15700	12500
230	19500	17500	14900
220	20900	19300	17000
210	22300	20900	19100
200	23700	22400	20900
190	25200	23900	22400
180	26600	25500	24100
170	28100	27000	25800
160	29600	28600	27400
150	31200	30300	29100
140	32900	32000	31000
130	34700	33800	32900
120	36600	35800	34800

With engine anti-ice on, decrease altitude capability by 1000 ft.

With engine and wing anti-ice on, decrease altitude capability by 3400 ft.

**ENGINE INOP**

**MAX CONTINUOUS THRUST**

**Long Range Cruise Control**

WEIGHT (1000 LB)		PRESSURE ALTITUDE (1000 FT)								
		10	14	18	21	23	25	27	29	31
260	EPR	1.57	1.65							
	MACH	.574	.606							
	KIAS	319	313							
	FF/ENG	9867	9808							
240	EPR	1.54	1.61	1.70						
	MACH	.557	.590	.623						
	KIAS	309	304	298						
	FF/ENG	9127	9040	9034						
220	EPR	1.50	1.57	1.65	1.72					
	MACH	.539	.572	.605	.632					
	KIAS	299	295	289	285					
	FF/ENG	8411	8292	8244	8273					
200	EPR	1.47	1.53	1.61	1.67	1.72	1.77			
	MACH	.519	.552	.586	.611	.629	.650			
	KIAS	288	284	279	275	272	270			
	FF/ENG	7710	7557	7483	7466	7487	7555			
180	EPR	1.43	1.49	1.56	1.62	1.67	1.71	1.76		
	MACH	.497	.530	.564	.590	.607	.625	.646		
	KIAS	275	272	269	265	262	259	257		
	FF/ENG	7015	6856	6744	6702	6692	6702	6773		
160	EPR	1.40	1.45	1.51	1.57	1.61	1.66	1.70	1.75	1.80
	MACH	.474	.505	.539	.566	.583	.601	.619	.639	.661
	KIAS	262	260	257	254	251	249	246	244	242
	FF/ENG	6347	6161	6030	5964	5936	5922	5925	5984	6108
140	EPR	1.36	1.41	1.47	1.51	1.55	1.59	1.64	1.68	1.73
	MACH	.448	.479	.511	.538	.555	.573	.591	.610	.629
	KIAS	247	246	243	241	239	237	234	232	229
	FF/ENG	5655	5491	5339	5253	5207	5177	5159	5155	5193
120	EPR	1.31	1.36	1.41	1.46	1.49	1.53	1.57	1.61	1.66
	MACH	.413	.448	.481	.505	.523	.541	.560	.578	.597
	KIAS	228	230	228	226	224	223	221	219	217
	FF/ENG	4875	4811	4668	4565	4513	4463	4428	4406	4394



**ENGINE INOP**

**MAX CONTINUOUS THRUST**

**Long Range Cruise Diversion Fuel and Time  
Ground to Air Miles Conversion**

AIR DISTANCE (NM)					GROUND DISTANCE (NM)	AIR DISTANCE (NM)				
HEADWIND COMPONENT (KTS)						TAILWIND COMPONENT (KTS)				
100	80	60	40	20		20	40	60	80	100
288	265	245	228	213	200	190	181	173	166	159
576	531	490	456	427	400	381	363	347	332	319
866	797	736	684	640	600	572	545	521	499	479
1156	1064	982	913	853	800	762	726	694	665	639
1448	1332	1229	1142	1067	1000	952	909	868	832	799
1741	1601	1477	1372	1281	1200	1143	1090	1041	997	958
2036	1871	1725	1602	1495	1400	1333	1271	1214	1163	1117
2332	2142	1974	1832	1709	1600	1523	1452	1387	1329	1276
2630	2414	2223	2062	1924	1800	1713	1633	1560	1494	1434

**Reference Fuel and Time Required at Check Point**

AIR DIST (NM)	PRESSURE ALTITUDE (1000 FT)									
	10		14		18		22		28	
	FUEL (1000 LB)	TIME (HR:MIN)	FUEL (1000 LB)	TIME (HR:MIN)	FUEL (1000 LB)	TIME (HR:MIN)	FUEL (1000 LB)	TIME (HR:MIN)	FUEL (1000 LB)	TIME (HR:MIN)
200	4.5	0:41	3.9	0:40	3.5	0:39	3.2	0:38	2.8	0:36
400	9.2	1:18	8.3	1:15	7.7	1:12	7.2	1:10	6.7	1:06
600	13.9	1:55	12.7	1:50	11.8	1:46	11.1	1:42	10.5	1:36
800	18.5	2:32	17.0	2:26	15.9	2:20	15.0	2:14	14.2	2:06
1000	23.0	3:10	21.2	3:02	19.9	2:54	18.8	2:47	17.8	2:37
1200	27.5	3:48	25.4	3:38	23.8	3:28	22.5	3:20	21.4	3:07
1400	32.0	4:27	29.6	4:14	27.7	4:03	26.3	3:53	24.9	3:38
1600	36.4	5:06	33.7	4:51	31.6	4:38	29.9	4:27	28.4	4:09
1800	40.7	5:45	37.8	5:29	35.4	5:13	33.5	5:00	31.8	4:41

**Fuel Required Adjustment (1000 LB)**

REFERENCE FUEL REQUIRED (1000 LB)	WEIGHT AT CHECK POINT (1000 LB)					
	160	180	200	220	240	260
5	-0.4	-0.2	0.0	0.3	0.6	1.0
10	-0.8	-0.4	0.0	0.8	1.5	2.2
15	-1.3	-0.7	0.0	1.2	2.3	3.5
20	-1.7	-0.9	0.0	1.6	3.2	4.8
25	-2.2	-1.1	0.0	2.1	4.1	6.1
30	-2.7	-1.3	0.0	2.5	4.9	7.3
35	-3.1	-1.6	0.0	2.9	5.8	8.6
40	-3.6	-1.8	0.0	3.3	6.7	9.9
45	-4.1	-2.0	0.0	3.8	7.6	11.3

Includes APU fuel burn.

**ENGINE INOP**

**MAX CONTINUOUS THRUST**

**Holding  
Flaps Up**

WEIGHT (1000 LB)		PRESSURE ALTITUDE (FT)						
		1500	5000	10000	15000	20000	25000	30000
260	EPR	1.39	1.45	1.54	1.65			
	KIAS	235	235	235	235			
	FF/ENG	8720	8640	8590	8710			
240	EPR	1.37	1.41	1.50	1.60	1.73		
	KIAS	228	228	228	228	228		
	FF/ENG	8070	7970	7890	7930	8170		
220	EPR	1.34	1.38	1.46	1.55	1.67		
	KIAS	220	220	220	220	220		
	FF/ENG	7420	7320	7220	7200	7330		
200	EPR	1.31	1.35	1.42	1.51	1.61	1.75	
	KIAS	213	213	213	213	213	213	
	FF/ENG	6770	6680	6570	6510	6550	6790	
180	EPR	1.28	1.32	1.38	1.46	1.56	1.68	
	KIAS	205	205	205	205	205	205	
	FF/ENG	6130	6050	5940	5850	5830	5950	
160	EPR	1.25	1.28	1.34	1.41	1.50	1.61	1.75
	KIAS	197	197	197	197	197	197	197
	FF/ENG	5490	5430	5320	5220	5160	5190	5420
140	EPR	1.22	1.25	1.30	1.36	1.44	1.54	1.66
	KIAS	188	188	188	188	188	188	188
	FF/ENG	4870	4800	4710	4620	4540	4510	4580
120	EPR	1.19	1.22	1.26	1.32	1.39	1.47	1.58
	KIAS	179	179	179	179	179	179	179
	FF/ENG	4250	4190	4110	4030	3940	3880	3870

This table includes 5% additional fuel for holding in a racetrack pattern.

**Performance Inflight**  
**Alternate Thrust Setting**

**Chapter PI**  
**Section 14**

**ALTERNATE THRUST SETTING**

**Takeoff Performance**

PERFORMANCE LIMIT	WEIGHT ADJUSTMENT (1000 LB)			
	FLAPS 1	FLAPS 5	FLAPS 15	FLAPS 20
FIELD	-9.2	-9.2	-9.1	-9.1
TIRE SPEED	-1.1	-1.1	-1.1	-1.1
CLIMB	-17.9	-17.3	-16.5	-15.3
OBSTACLE	-17.9	-17.3	-16.5	-15.5

**Takeoff Speeds**

TAKEOFF SPEEDS	TAKEOFF SPEED ADJUSTMENT (KTS)
V1	+2
VR	+1
V2	0

**Enroute Performance**

PERFORMANCE LIMIT	WEIGHT ADJUSTMENT (1000 LB)
ENROUTE CLIMB	-15.1

**Landing Performance**

PERFORMANCE LIMIT	WEIGHT ADJUSTMENT (1000 LB)
APPROACH/LANDING CLIMB	-16.2

**ALTERNATE THRUST SETTING**

**Takeoff %N1**

Based on engine bleed for packs on, engine anti-ice on or off and wing anti-ice off

AIRPORT OAT		AIRPORT PRESSURE ALTITUDE (FT)											
°F	°C	-1000	0	1000	2000	3000	4000	5000	6000	7000	8000	9000	10000
131	55	96.7	96.7	96.7	96.6	96.6	96.6	96.6	96.6	96.6	96.6	96.7	96.2
122	50	97.6	97.6	97.5	97.6	97.5	97.5	97.5	97.5	97.5	97.6	97.3	96.8
113	45	98.3	98.2	98.1	98.3	98.3	98.3	98.3	98.3	98.3	98.4	98.0	97.4
104	40	99.0	98.9	98.8	99.0	99.2	99.1	99.1	99.1	99.2	99.2	98.7	98.1
95	35	99.7	99.6	99.5	99.7	100.0	100.0	100.0	100.0	100.0	99.9	99.4	98.8
86	30	100.1	100.3	100.3	100.5	100.7	100.9	100.9	100.9	100.9	100.7	100.1	99.5
77	25	99.3	99.9	100.5	101.3	101.6	101.9	101.8	101.7	101.7	101.5	100.9	100.3
68	20	98.5	99.0	99.6	100.5	101.5	102.5	102.8	102.8	102.7	102.5	101.8	101.2
59	15	97.6	98.2	98.8	99.6	100.6	101.6	102.2	102.9	103.6	103.4	102.8	102.2
50	10	96.8	97.3	97.9	98.8	99.7	100.7	101.3	102.0	102.7	103.3	103.4	103.2
41	5	95.9	96.5	97.1	97.9	98.8	99.9	100.4	101.1	101.8	102.4	102.5	102.6
32	0	95.0	95.6	96.2	97.0	98.0	98.9	99.5	100.2	100.9	101.5	101.6	101.7
23	-5	94.2	94.7	95.3	96.1	97.1	98.0	98.6	99.3	100.0	100.5	100.7	100.8
14	-10	93.3	93.8	94.4	95.2	96.1	97.1	97.7	98.3	99.0	99.6	99.7	99.8
5	-15	92.4	92.9	93.5	94.3	95.2	96.2	96.8	97.4	98.1	98.6	98.8	98.9
-4	-20	91.5	92.0	92.6	93.4	94.3	95.3	95.8	96.4	97.1	97.7	97.8	97.9
-13	-25	90.6	91.1	91.7	92.4	93.4	94.3	94.9	95.5	96.2	96.7	96.8	96.9
-22	-30	89.7	90.2	90.7	91.5	92.4	93.4	93.9	94.5	95.2	95.7	95.8	96.0
-31	-35	88.7	89.3	89.8	90.6	91.5	92.4	92.9	93.5	94.2	94.7	94.9	95.0
-40	-40	87.8	88.3	88.9	89.6	90.5	91.4	92.0	92.6	93.2	93.7	93.9	94.0
-49	-45	86.9	87.4	87.9	88.6	89.5	90.4	91.0	91.6	92.2	92.7	92.8	92.9
-58	-50	85.9	86.4	86.9	87.7	88.5	89.4	90.0	90.5	91.2	91.7	91.8	91.9

**%N1 Adjustments for Engine Bleeds**

BLEED CONFIGURATION	AIRPORT PRESSURE ALTITUDE (FT)												
	-1000	0	1000	2000	3000	4000	5000	6000	7000	8000	9000	10000	
PACKS OFF	0.5	0.5	0.5	0.5	0.5	0.5	0.5	0.5	0.5	0.5	0.5	0.5	0.5
WING ANTI-ICE ON	-0.6	-0.6	-0.6	-0.6	-0.6	-0.6	-0.6	-0.6	-0.6	-0.6	-0.6	-0.6	-0.6

**ALTERNATE THRUST SETTING**

**Go-around %N1**

Based on engine bleed for packs on and anti-ice off

REPORTED OAT		TAT (°C)	AIRPORT PRESSURE ALTITUDE (FT)											
°F	°C		-1000	0	1000	2000	3000	4000	5000	6000	7000	8000	9000	10000
131	55	58	97.1	97.0	97.0	97.1	97.4	97.6	97.5	97.5	97.5	97.3	96.8	96.2
122	50	53	97.7	97.7	97.6	97.8	98.0	98.3	98.2	98.1	98.1	97.9	97.4	96.8
113	45	48	98.3	98.3	98.2	98.4	98.6	98.9	98.8	98.8	98.7	98.6	98.0	97.5
104	40	43	99.0	99.0	98.9	99.1	99.4	99.6	99.5	99.5	99.5	99.3	98.7	98.1
95	35	38	99.7	99.7	99.6	99.8	100.1	100.4	100.3	100.2	100.2	100.0	99.5	98.9
86	30	33	100.3	100.5	100.4	100.6	100.8	101.1	101.0	101.0	101.0	100.8	100.2	99.6
77	25	28	99.4	100.0	100.5	101.4	101.7	102.0	101.9	101.8	101.8	101.6	101.0	100.4
68	20	23	98.6	99.1	99.7	100.6	101.5	102.5	102.7	102.7	102.7	102.5	101.9	101.2
59	15	18	97.8	98.3	98.8	99.7	100.7	101.6	102.2	103.0	103.6	103.5	102.8	102.2
50	10	13	96.9	97.4	98.0	98.8	99.8	100.7	101.3	102.1	102.7	103.3	103.4	103.1
41	5	8	96.0	96.6	97.1	97.9	98.9	99.8	100.4	101.1	101.8	102.4	102.5	102.6
32	0	3	95.2	95.7	96.2	97.1	98.0	98.9	99.5	100.2	100.9	101.5	101.5	101.7
23	-5	-2	94.3	94.8	95.3	96.2	97.1	98.0	98.6	99.3	100.0	100.5	100.6	100.7
14	-10	-7	93.4	93.9	94.5	95.3	96.2	97.1	97.7	98.4	99.0	99.6	99.7	99.8
5	-15	-13	92.5	93.0	93.6	94.4	95.3	96.2	96.8	97.4	98.1	98.6	98.7	98.8
-4	-20	-18	91.6	92.1	92.6	93.4	94.4	95.2	95.8	96.5	97.1	97.7	97.8	97.9
-13	-25	-23	90.7	91.2	91.7	92.5	93.4	94.3	94.9	95.5	96.2	96.7	96.8	96.9
-22	-30	-28	89.8	90.3	90.8	91.6	92.5	93.3	93.9	94.6	95.2	95.7	95.8	95.9
-31	-35	-33	88.9	89.4	89.9	90.6	91.5	92.4	92.9	93.6	94.2	94.7	94.8	94.9
-40	-40	-38	87.9	88.4	88.9	89.7	90.6	91.4	91.9	92.6	93.2	93.7	93.8	93.9
-49	-45	-43	87.0	87.5	87.9	88.7	89.6	90.4	91.0	91.6	92.2	92.7	92.8	92.9
-58	-50	-48	86.0	86.5	87.0	87.7	88.6	89.4	90.0	90.6	91.2	91.7	91.8	91.9

**%N1 Adjustments for Engine Bleeds**

BLEED CONFIGURATION	AIRPORT PRESSURE ALTITUDE (FT)												
	-1000	0	1000	2000	3000	4000	5000	6000	7000	8000	9000	10000	
PACKS OFF	0.5	0.5	0.5	0.5	0.5	0.5	0.5	0.5	0.5	0.5	0.5	0.5	0.5
WING ANTI-ICE ON	-0.6	-0.6	-0.6	-0.6	-0.6	-0.6	-0.6	-0.6	-0.6	-0.6	-0.6	-0.6	-0.6

**ALTERNATE THRUST SETTING**

**Max Climb %N1**

Based on engine bleed for packs on and anti-ice off

TAT (°C)	PRESSURE ALTITUDE (1000 FT)/SPEED (KIAS OR MACH)								
	0	5	10	15	20	25	30	35	40
	250	250	250	290	290	290	290	.78	.78
60	91.3	92.3							
50	92.9	93.7	93.9						
40	94.2	95.0	95.1	95.7	96.1				
30	94.5	96.3	96.4	97.0	97.4	96.9			
20	92.9	96.3	98.1	98.8	99.1	98.5	97.3		
10	91.3	94.6	97.6	99.5	100.9	100.2	98.9	97.5	96.8
0	89.7	92.9	95.8	97.7	100.5	101.9	100.4	99.0	98.2
-10	88.0	91.2	94.0	95.9	98.7	100.2	100.8	100.7	100.0
-20	86.3	89.5	92.2	94.1	96.8	98.2	98.9	101.2	101.7
-30	84.6	87.7	90.4	92.2	94.8	96.3	96.9	99.2	99.6
-40	82.8	85.9	88.5	90.3	92.9	94.3	94.9	97.2	97.6
-50	81.0	84.0	86.6	88.3	90.8	92.2	92.8	95.1	95.4

**%N1 Adjustments for Engine Bleeds**

BLEED CONFIGURATION	PRESSURE ALTITUDE (1000 FT)									
	0	5	10	15	20	25	30	35	40	
PACKS OFF	0.6	0.8	0.7	0.4	0.9	1.1	1.0	1.0	1.3	
ENGINE ANTI-ICE ON	-0.3	-0.4	-0.5	-0.6	-0.8	-1.3	-1.6	-1.8	-2.2	
ENGINE & WING ANTI-ICE ON	-0.7	-0.9	-1.1	-1.3	-1.8	-2.9	-3.6	-4.1	-5.0	

**Max Cruise %N1**

Based on engine bleed for packs on and anti-ice off

TAT (°C)	PRESSURE ALTITUDE (1000 FT)								
	25	27	29	31	33	35	37	39	41
25	92.2	92.2	92.1	92.1	92.2	92.2	91.9	91.6	91.3
20	92.8	92.8	92.7	92.7	92.8	92.8	92.5	92.2	92.0
15	93.4	93.3	93.3	93.3	93.3	93.4	93.1	92.8	92.6
10	94.0	94.0	94.0	94.0	94.1	94.2	93.9	93.6	93.4
5	94.0	94.7	94.7	94.8	94.8	94.9	94.6	94.4	94.1
0	93.2	94.6	95.5	95.5	95.5	95.6	95.3	95.0	94.8
-5	92.3	93.7	95.1	96.3	96.3	96.4	96.0	95.7	95.5
-10	91.4	92.8	94.2	95.7	97.1	97.1	96.8	96.5	96.2
-15	90.6	92.0	93.3	94.8	96.3	98.0	97.7	97.3	97.1
-20	89.7	91.1	92.4	93.9	95.4	97.1	97.7	97.4	97.1
-25	88.8	90.2	91.5	93.0	94.5	96.1	96.7	96.4	96.2
-30	87.9	89.3	90.6	92.0	93.5	95.2	95.7	95.4	95.2
-35	87.0	88.3	89.6	91.1	92.5	94.2	94.7	94.4	94.2

**%N1 Adjustments for Engine Bleeds**

BLEED CONFIGURATION	PRESSURE ALTITUDE (1000 FT)									
	25	27	29	31	33	35	37	39	41	
PACKS OFF	1.1	1.0	1.0	1.0	1.0	1.0	1.2	1.3	1.3	
ENGINE ANTI-ICE ON	-1.3	-1.4	-1.5	-1.6	-1.7	-1.7	-1.9	-2.1	-2.1	
ENGINE & WING ANTI-ICE ON	-2.9	-3.2	-3.4	-3.6	-3.8	-3.9	-4.3	-4.7	-4.8	

**ALTERNATE THRUST SETTING**  
**ENGINE INOP**

**Initial Max Continuous %N1**

Based on engine bleed for one pack on and anti-ice off

TAT (°C)	PRESSURE ALTITUDE (1000 FT)								
	27	29	31	33	35	37	39	41	43
20	98.3	97.7	97.2	96.7	96.2	95.9	95.6	95.4	95.2
15	99.0	98.5	97.9	97.4	96.8	96.5	96.3	96.0	95.8
10	99.9	99.3	98.7	98.1	97.6	97.3	97.0	96.7	96.6
5	100.7	100.0	99.5	98.9	98.3	98.0	97.7	97.4	97.3
0	100.5	100.8	100.2	99.6	99.1	98.7	98.4	98.2	98.0
-5	99.6	100.4	101.1	100.5	99.9	99.6	99.3	99.1	98.9
-10	98.6	99.5	100.5	101.3	100.7	100.4	100.1	99.9	99.8
-15	97.7	98.5	99.5	100.5	101.7	101.4	101.1	101.0	100.9
-20	96.8	97.6	98.6	99.6	100.7	101.4	101.1	101.0	100.9
-25	95.8	96.6	97.6	98.6	99.7	100.4	100.1	100.0	99.9
-30	94.8	95.6	96.6	97.6	98.7	99.4	99.1	99.0	98.9
-35	93.8	94.6	95.6	96.6	97.7	98.3	98.1	98.0	97.9
-40	92.9	93.7	94.6	95.5	96.6	97.3	97.1	96.9	96.9

**%N1 Adjustments for Engine Bleed**

BLEED CONFIGURATION	PRESSURE ALTITUDE (1000 FT)								
	27	29	31	33	35	37	39	41	43
PACKS OFF*	1.0	1.0	1.0	1.0	1.0	1.2	1.3	1.3	1.1
ENGINE ANTI-ICE ON	-1.4	-1.5	-1.6	-1.7	-1.7	-1.9	-2.1	-2.1	-2.1
ENGINE & WING ANTI-ICE ON	-3.2	-3.4	-3.6	-3.8	-3.9	-4.3	-4.7	-4.8	-5.0

\*Do not apply packs off adjustment with wing anti-ice on

**ALTERNATE THRUST SETTING**

**ENGINE INOP**

**Max Continuous %N1**

Based on engine bleed for one pack on and anti-ice off

37000 FT to 20000 FT Pressure Altitudes

37000 FT PRESS ALT		TAT (°C)											
CIAS	M	-40	-35	-30	-25	-20	-15	-10	-5	0	5	10	15
200	.63	102.2	103.3	104.3	103.6	102.2	101.0	99.9	99.0	98.1	97.4	96.6	95.9
220	.69	100.6	101.7	102.7	103.8	102.5	101.3	100.3	99.4	98.5	97.7	97.0	96.2
240	.75	98.9	100.0	101.0	102.0	102.5	101.4	100.4	99.5	98.6	97.9	97.1	96.4
260	.80	97.3	98.3	99.3	100.4	101.4	101.4	100.4	99.6	98.7	98.0	97.3	96.6
33000 FT PRESS ALT		TAT (°C)											
CIAS	M	-40	-35	-30	-25	-20	-15	-10	-5	0	5	10	15
200	.58	101.1	102.1	103.2	104.3	102.8	101.5	100.4	99.6	98.7	97.9	97.2	96.4
220	.63	99.7	100.8	101.8	102.9	103.1	101.8	100.8	99.9	99.0	98.3	97.5	96.7
240	.68	98.5	99.6	100.6	101.6	102.6	102.1	101.1	100.3	99.4	98.6	97.8	97.0
260	.74	97.2	98.2	99.2	100.3	101.3	102.2	101.2	100.4	99.5	98.8	98.0	97.2
29000 FT PRESS ALT		TAT (°C)											
CIAS	M	-40	-35	-30	-25	-20	-15	-10	-5	0	5	10	15
200	.53	99.3	100.3	101.4	102.4	103.4	102.5	101.4	100.5	99.6	98.8	98.0	97.2
220	.58	98.2	99.3	100.3	101.3	102.3	102.8	101.7	100.8	99.9	99.1	98.3	97.5
240	.63	97.3	98.3	99.4	100.4	101.4	102.4	102.0	101.1	100.2	99.4	98.6	97.8
260	.68	96.4	97.4	98.4	99.4	100.4	101.4	102.3	101.4	100.5	99.7	98.9	98.0
25000 FT PRESS ALT		TAT (°C)											
CIAS	M	-40	-35	-30	-25	-20	-15	-10	-5	0	5	10	15
200	.49	97.7	98.7	99.8	100.8	101.8	102.8	102.6	101.6	100.6	99.8	99.0	98.1
220	.53	96.9	98.0	99.0	100.0	101.0	102.0	102.8	101.9	100.9	100.0	99.2	98.4
240	.58	96.2	97.2	98.2	99.2	100.2	101.2	102.2	102.2	101.2	100.3	99.5	98.7
260	.63	95.5	96.5	97.5	98.5	99.5	100.5	101.5	102.4	101.5	100.6	99.8	98.9
22000 FT PRESS ALT		TAT (°C)											
CIAS	M	-15	-10	-5	0	5	10	15	20	25	30	35	40
200	.46	101.3	102.3	102.2	101.2	100.3	99.5	98.6	97.8	96.9	96.1	95.5	
240	.55	100.1	101.0	102.0	101.7	100.8	100.0	99.1	98.2	97.4	96.6	95.9	
280	.63	98.7	99.7	100.6	101.5	101.3	100.5	99.6	98.7	97.9	97.1	96.4	
20000 FT PRESS ALT		TAT (°C)											
CIAS	M	-15	-10	-5	0	5	10	15	20	25	30	35	40
200	.44	100.5	101.5	102.4	101.6	100.7	99.8	98.9	98.1	97.2	96.4	95.7	
240	.53	99.3	100.2	101.2	102.0	101.1	100.3	99.3	98.5	97.6	96.8	96.1	
280	.61	98.1	99.0	100.0	100.9	101.7	100.8	99.8	99.0	98.1	97.2	96.6	

**%N1 Adjustments for Engine Bleed**

BLEED CONFIGURATION	PRESSURE ALTITUDE (1000 FT)					
	20	22	25	29	33	37
PACKS OFF	0.9	1.0	1.1	1.0	1.0	1.2
ENGINE ANTI-ICE ON	-0.8	-1.0	-1.3	-1.5	-1.6	-1.9
ENGINE & WING ANTI-ICE ON	-1.8	-2.2	-2.9	-3.4	-3.7	-4.3



**ALTERNATE THRUST SETTING**  
**ENGINE INOP**

**Max Continuous %N1**

Based on engine bleed for one pack on and anti-ice off

18000 FT to 8000 FT Pressure Altitudes

18000 FT PRESS ALT			TAT (°C)									
CIAS	M	-15	-10	-5	0	5	10	15	20	25	30	35
200	.42	99.2	100.2	101.1	101.6	100.6	99.8	98.8	98.0	97.1	96.3	95.6
240	.51	98.1	99.1	100.0	101.0	101.0	100.1	99.2	98.4	97.5	96.7	96.0
280	.59	97.0	97.9	98.8	99.7	100.7	100.6	99.7	98.8	97.9	97.1	96.4
16000 FT PRESS ALT			TAT (°C)									
CIAS	M	-15	-10	-5	0	5	10	15	20	25	30	35
200	.41	97.9	98.9	99.8	100.8	100.6	99.7	98.7	97.9	97.0	96.2	95.6
240	.49	96.9	97.9	98.8	99.7	100.6	100.0	99.1	98.3	97.4	96.6	95.9
280	.57	95.9	96.8	97.7	98.6	99.5	100.4	99.6	98.7	97.8	97.0	96.3
14000 FT PRESS ALT			TAT (°C)									
CIAS	M	-15	-10	-5	0	5	10	15	20	25	30	35
200	.39	96.6	97.6	98.5	99.4	100.3	99.6	98.7	97.8	97.0	96.2	95.5
240	.47	95.7	96.7	97.6	98.5	99.4	100.0	99.0	98.2	97.3	96.5	95.8
280	.54	94.7	95.6	96.5	97.4	98.3	99.2	99.4	98.6	97.7	96.9	96.2
12000 FT PRESS ALT			TAT (°C)									
CIAS	M	-10	-5	0	5	10	15	20	25	30	35	40
200	.38	96.3	97.2	98.1	99.0	99.5	98.6	97.8	96.9	96.1	95.4	94.8
240	.45	95.5	96.4	97.3	98.2	99.1	98.9	98.1	97.2	96.4	95.8	95.1
10000 FT PRESS ALT			TAT (°C)									
CIAS	M	-10	-5	0	5	10	15	20	25	30	35	40
200	.36	95.0	95.9	96.8	97.7	98.6	98.5	97.7	96.8	96.1	95.4	94.8
240	.43	94.2	95.1	96.0	96.9	97.8	98.6	98.0	97.2	96.4	95.7	95.1
8000 FT PRESS ALT			TAT (°C)									
CIAS	M	-10	-5	0	5	10	15	20	25	30	35	40
200	.35	93.7	94.6	95.5	96.3	97.2	98.0	97.6	96.8	96.0	95.3	94.7
240	.42	93.1	94.0	94.9	95.7	96.6	97.4	98.0	97.1	96.3	95.6	95.0

**%N1 Adjustments for Engine Bleed**

BLEED CONFIGURATION	PRESSURE ALTITUDE (1000 FT)					
	8	10	12	14	16	18
PACKS OFF	0.7	0.7	0.6	0.5	0.5	0.7
ENGINE ANTI-ICE ON	-0.4	-0.5	-0.5	-0.5	-0.6	-0.7
ENGINE & WING ANTI-ICE ON	-1.0	-1.1	-1.1	-1.2	-1.4	-1.6

**ALTERNATE THRUST SETTING**

**ENGINE INOP**

**Max Continuous %N1**

Based on engine bleed for one pack on and anti-ice off

6000 FT to Sea Level Pressure Altitudes

6000 FT PRESS ALT		TAT (°C)										
CIAS	M	-10	-5	0	5	10	15	20	25	30	35	40
200	.34	92.5	93.4	94.3	95.1	96.0	96.8	97.5	96.7	95.9	95.3	94.7
240	.40	92.0	92.9	93.7	94.6	95.4	96.3	97.1	97.0	96.2	95.5	94.9
4000 FT PRESS ALT		TAT (°C)										
CIAS	M	-10	-5	0	5	10	15	20	25	30	35	40
200	.32	91.2	92.1	92.9	93.8	94.6	95.5	96.3	96.5	95.8	95.1	94.5
240	.39	90.7	91.6	92.4	93.3	94.1	94.9	95.7	96.6	96.0	95.4	94.7
2000 FT PRESS ALT		TAT (°C)										
CIAS	M	-10	-5	0	5	10	15	20	25	30	35	40
200	.31	89.9	90.7	91.6	92.4	93.2	94.0	94.8	95.7	95.5	94.8	94.2
240	.38	89.4	90.2	91.1	91.9	92.7	93.5	94.3	95.1	95.7	95.1	94.5
0 FT PRESS ALT		TAT (°C)										
CIAS	M	-10	-5	0	5	10	15	20	25	30	35	40
200	.30	88.5	89.4	90.2	91.0	91.9	92.7	93.5	94.3	95.0	94.6	93.9
240	.36	88.1	89.0	89.8	90.6	91.4	92.2	93.0	93.8	94.6	94.8	94.2

**%N1 Adjustments for Engine Bleed**

BLEED CONFIGURATION	PRESSURE ALTITUDE (1000 FT)			
	0	2	4	6
PACKS OFF	0.6	0.7	0.8	0.8
ENGINE ANTI-ICE ON	-0.3	-0.3	-0.4	-0.4
ENGINE & WING ANTI-ICE ON	-0.7	-0.8	-0.9	-0.9

**Performance Inflight**  
**Gear Down**

**Chapter PI**  
**Section 15**

**GEAR DOWN**

**210 KIAS Max Climb EPR**

Based on engine bleed for packs on and anti-ice off

TAT (°C)	PRESSURE ALTITUDE (1000 FT)														
	0	5	10	12	14	16	18	20	22	24	26	28	30	32	34
55	1.43	1.43	1.43	1.43	1.43	1.43	1.42	1.42	1.42	1.41	1.41	1.41	1.41	1.41	1.41
50	1.45	1.45	1.45	1.45	1.45	1.45	1.45	1.44	1.44	1.44	1.44	1.44	1.44	1.44	1.44
45	1.48	1.48	1.48	1.48	1.48	1.48	1.47	1.47	1.47	1.46	1.46	1.46	1.46	1.46	1.46
40	1.50	1.50	1.50	1.50	1.50	1.50	1.50	1.49	1.49	1.49	1.49	1.49	1.49	1.49	1.49
35	1.53	1.53	1.53	1.53	1.53	1.53	1.52	1.52	1.52	1.51	1.51	1.51	1.51	1.52	1.52
30	1.55	1.56	1.55	1.55	1.56	1.55	1.55	1.54	1.54	1.54	1.54	1.54	1.54	1.54	1.54
25	1.55	1.58	1.58	1.58	1.58	1.58	1.58	1.57	1.57	1.57	1.57	1.57	1.57	1.57	1.57
20	1.55	1.60	1.61	1.61	1.61	1.61	1.60	1.60	1.60	1.60	1.60	1.60	1.60	1.60	1.61
15	1.55	1.60	1.64	1.64	1.64	1.64	1.64	1.63	1.63	1.63	1.63	1.63	1.63	1.64	1.64
10	1.55	1.60	1.65	1.67	1.68	1.67	1.67	1.66	1.66	1.66	1.66	1.66	1.66	1.67	1.67
5	1.55	1.60	1.65	1.68	1.70	1.70	1.70	1.69	1.69	1.69	1.69	1.69	1.69	1.70	1.70
0	1.55	1.60	1.65	1.68	1.70	1.71	1.72	1.72	1.72	1.72	1.72	1.72	1.72	1.72	1.73
-5	1.55	1.60	1.65	1.68	1.70	1.71	1.73	1.74	1.75	1.74	1.74	1.75	1.75	1.75	1.75
-10	1.55	1.60	1.65	1.68	1.70	1.71	1.73	1.74	1.76	1.77	1.77	1.77	1.77	1.77	1.77
-15	1.55	1.60	1.65	1.68	1.70	1.71	1.73	1.74	1.76	1.77	1.78	1.79	1.79	1.79	1.79
-20	1.55	1.60	1.65	1.68	1.70	1.71	1.73	1.74	1.76	1.77	1.78	1.79	1.80	1.81	1.81
-25	1.55	1.60	1.65	1.68	1.70	1.71	1.73	1.74	1.76	1.77	1.78	1.79	1.80	1.82	1.83
-30	1.55	1.60	1.65	1.68	1.70	1.71	1.73	1.74	1.76	1.77	1.78	1.79	1.80	1.82	1.83

**EPR Adjustments for Engine Bleeds**

BLEED CONFIGURATION	PRESSURE ALTITUDE (1000 FT)														
	0	5	10	12	14	16	20	24	26	28	30	32	34		
PACKS OFF	0.01	0.01	0.01	0.01	0.01	0.01	0.01	0.01	0.01	0.01	0.01	0.01	0.01	0.01	0.01
ENGINE ANTI-ICE ON	0.00	-0.01	-0.01	-0.01	-0.01	-0.01	-0.01	-0.01	-0.01	-0.01	-0.01	-0.01	-0.01	-0.01	-0.02
ENGINE & WING ANTI-ICE ON	-0.01	-0.02	-0.02	-0.02	-0.02	-0.02	-0.02	-0.02	-0.02	-0.03	-0.03	-0.03	-0.03	-0.04	-0.04

**Long Range Cruise Altitude Capability**

WEIGHT (1000 LB)	PRESSURE ALTITUDE (FT)		
	ISA + 10°C & BELOW	ISA + 15°C	ISA + 20°C
260	19800	16700	13700
250	21400	18700	15800
240	23100	20600	17700
230	24800	22600	19600
220	26500	24400	21800
210	28200	26300	23900
200	29800	28200	26100
190	31200	29900	28200
180	32700	31500	30000
170	34100	33100	31700
160	35600	34700	33500
150	36800	36100	35200
140	37900	37300	36600
130	39200	38500	37800
120	40500	39700	39000

**GEAR DOWN**

**Long Range Cruise Control**

WEIGHT (1000 LB)		PRESSURE ALTITUDE (1000 FT)										
		10	14	18	21	23	25	27	29	31	33	35
260	EPR	1.47	1.54	1.62								
	MACH	.455	.485	.515								
	KIAS	254	251	247								
	FF/ENG	7405	7267	7158								
240	EPR	1.44	1.51	1.58	1.64	1.69						
	MACH	.440	.470	.500	.524	.540						
	KIAS	246	243	240	237	234						
	FF/ENG	6877	6730	6607	6555	6541						
220	EPR	1.41	1.47	1.54	1.60	1.64	1.69					
	MACH	.424	.453	.484	.508	.524	.540					
	KIAS	236	234	232	229	227	225					
	FF/ENG	6331	6190	6074	6002	5968	5955					
200	EPR	1.38	1.44	1.50	1.56	1.60	1.64	1.69	1.74			
	MACH	.406	.436	.466	.490	.506	.522	.539	.556			
	KIAS	226	225	223	221	219	217	215	213			
	FF/ENG	5780	5673	5543	5460	5420	5383	5377	5408			
180	EPR	1.34	1.40	1.46	1.51	1.55	1.59	1.63	1.68	1.73		
	MACH	.384	.416	.446	.470	.486	.502	.519	.537	.560		
	KIAS	214	215	213	212	210	208	207	205	205		
	FF/ENG	5205	5128	5015	4937	4888	4843	4816	4815	4908		
160	EPR	1.31	1.36	1.42	1.46	1.50	1.54	1.58	1.62	1.67	1.73	1.79
	MACH	.363	.393	.424	.448	.464	.480	.496	.516	.539	.562	.587
	KIAS	202	202	202	201	200	199	197	197	197	197	197
	FF/ENG	4640	4573	4490	4414	4366	4315	4277	4282	4320	4409	4528
140	EPR	1.27	1.32	1.37	1.41	1.45	1.48	1.52	1.57	1.61	1.66	1.72
	MACH	.341	.367	.398	.423	.439	.456	.475	.495	.517	.539	.563
	KIAS	189	189	190	190	189	188	188	188	188	188	188
	FF/ENG	4080	4007	3950	3894	3854	3811	3796	3792	3802	3841	3911
120	EPR	1.24	1.28	1.33	1.37	1.40	1.43	1.47	1.51	1.55	1.60	1.65
	MACH	.323	.349	.377	.400	.417	.434	.453	.472	.493	.514	.537
	KIAS	179	179	179	179	179	179	179	179	179	179	179
	FF/ENG	3613	3558	3605	3440	3405	3425	3401	3384	3325	3339	3365

**GEAR DOWN**

**Long Range Cruise Enroute Fuel and Time  
Ground to Air Miles Conversion**

AIR DISTANCE (NM)					GROUND DISTANCE (NM)	AIR DISTANCE (NM)				
HEADWIND COMPONENT (KTS)						TAILWIND COMPONENT (KTS)				
100	80	60	40	20		20	40	60	80	100
327	292	261	237	217	200	188	178	168	160	152
659	586	524	475	435	400	377	356	337	319	304
998	886	791	715	654	600	565	533	504	478	456
1342	1189	1059	956	873	800	753	711	672	638	608
1692	1496	1329	1198	1092	1000	941	888	840	797	759
2048	1807	1602	1442	1312	1200	1129	1064	1006	954	909
2411	2123	1877	1686	1533	1400	1317	1241	1173	1112	1059
2781	2443	2155	1933	1754	1600	1504	1417	1339	1270	1209
3157	2766	2435	2180	1976	1800	1692	1593	1505	1427	1358

**Reference Fuel and Time Required at Check Point**

AIR DIST (NM)	PRESSURE ALTITUDE (1000 FT)									
	10		14		18		22		28	
	FUEL (1000 LB)	TIME (HR:MIN)	FUEL (1000 LB)	TIME (HR:MIN)	FUEL (1000 LB)	TIME (HR:MIN)	FUEL (1000 LB)	TIME (HR:MIN)	FUEL (1000 LB)	TIME (HR:MIN)
200	8.4	0:51	7.6	0:49	6.8	0:47	6.2	0:45	5.4	0:43
400	17.1	1:39	15.6	1:34	14.3	1:29	13.2	1:26	11.9	1:21
600	25.5	2:28	23.5	2:20	21.6	2:13	20.0	2:07	18.1	1:59
800	33.8	3:18	31.2	3:06	28.8	2:57	26.7	2:48	24.3	2:37
1000	41.9	4:10	38.7	3:54	35.8	3:41	33.3	3:30	30.3	3:16
1200	49.8	5:02	46.1	4:43	42.7	4:27	39.7	4:13	36.1	3:56
1400	57.5	5:56	53.3	5:33	49.4	5:13	46.0	4:57	41.8	4:36
1600	65.0	6:52	60.3	6:25	56.0	6:01	52.1	5:41	47.5	5:16
1800	72.3	7:48	67.2	7:17	62.5	6:50	58.2	6:26	52.9	5:57

**Fuel Required Adjustment (1000 LB)**

REFERENCE FUEL REQUIRED (1000 LB)	WEIGHT AT CHECK POINT (1000 LB)					
	160	180	200	220	240	260
10	-1.0	-0.5	0.0	0.7	1.4	2.2
20	-2.0	-1.0	0.0	1.5	3.0	4.6
30	-3.1	-1.5	0.0	2.2	4.5	6.9
40	-4.3	-2.1	0.0	2.9	5.9	9.1
50	-5.4	-2.6	0.0	3.5	7.3	11.2
60	-6.5	-3.2	0.0	4.2	8.6	13.2
70	-7.6	-3.8	0.0	4.7	9.8	15.1

**Descent at VREF30 + 80**

PRESSURE ALT (1000 FT)	5	10	15	17	19	21	23	25	27	29	31	33	35
DISTANCE (NM)	12	21	30	34	38	41	45	49	53	57	61	65	69
TIME (MINUTES)	7	9	11	12	13	13	14	15	16	16	17	18	18

**GEAR DOWN**

**Holding  
Flaps Up**

WEIGHT (1000 LB)		PRESSURE ALTITUDE (FT)						
		1500	5000	10000	15000	20000	25000	30000
260	EPR	1.33	1.37	1.45	1.54	1.64		
	KIAS	235	235	235	235	235		
	FF/ENG	7390	7280	7150	7090	7150		
240	EPR	1.31	1.35	1.42	1.50	1.60		
	KIAS	228	228	228	228	228		
	FF/ENG	6880	6780	6640	6560	6570		
220	EPR	1.29	1.32	1.39	1.47	1.56	1.68	
	KIAS	220	220	220	220	220	220	
	FF/ENG	6370	6290	6150	6050	6020	6110	
200	EPR	1.26	1.30	1.36	1.43	1.52	1.63	
	KIAS	213	213	213	213	213	213	
	FF/ENG	5870	5800	5670	5560	5490	5520	
180	EPR	1.24	1.27	1.33	1.40	1.48	1.58	1.71
	KIAS	205	205	205	205	205	205	205
	FF/ENG	5380	5310	5200	5080	5000	4980	5100
160	EPR	1.22	1.25	1.30	1.36	1.44	1.53	1.65
	KIAS	197	197	197	197	197	197	197
	FF/ENG	4900	4830	4730	4630	4530	4480	4510
140	EPR	1.20	1.23	1.27	1.33	1.40	1.48	1.59
	KIAS	188	188	188	188	188	188	188
	FF/ENG	4420	4350	4260	4180	4070	4000	3980
120	EPR	1.18	1.20	1.24	1.29	1.35	1.43	1.53
	KIAS	179	179	179	179	179	179	179
	FF/ENG	4270	3880	3790	3720	3630	3600	3550

This table includes 5% additional fuel for holding in a racetrack pattern.

**Performance Inflight**  
**Gear Down, Engine Inop**

**Chapter PI**  
**Section 16**

**GEAR DOWN**

**ENGINE INOP**

**MAX CONTINUOUS THRUST**

**Driftdown Speed/Level Off Altitude**

**100 ft/min residual rate of climb**

**Includes APU fuel burn**

WEIGHT (1000 LB)		OPTIMUM DRIFTDOWN SPEED (KIAS)	LEVEL OFF ALTITUDE (FT)		
START DRIFT DOWN	LEVEL OFF		ISA + 10°C & BELOW	ISA + 15°C	ISA + 20°C
240	226	225	3300		
220	208	218	7000	4900	2300
200	190	210	10500	8800	6600
180	171	203	14100	12700	10800
160	152	195	17400	16300	15000
140	134	187	20700	19900	18900

**Long Range Cruise Altitude Capability**

**100 ft/min residual rate of climb**

WEIGHT (1000 LB)	PRESSURE ALTITUDE (FT)		
	ISA+10°C & BELOW	ISA+15°C	ISA+20°C
210	5700	2100	
200	8100	5400	1300
190	10600	8100	5200
180	12400	10700	8100
170	14400	12800	10900
160	16200	14900	13200
150	17900	16800	15400
140	19700	18700	17500
130	21500	20600	19600
120	23200	22500	21500

**GEAR DOWN**

**ENGINE INOP**

**MAX CONTINUOUS THRUST**

**Long Range Cruise Control**

WEIGHT (1000 LB)		PRESSURE ALTITUDE (1000 FT)							
		6	8	10	12	14	16	18	20
200	EPR	1.62	1.66	1.70					
	MACH	.363	.374	.383					
	KIAS	217	216	213					
	FF/ENG	10785	10750	10700					
180	EPR	1.56	1.60	1.65	1.69	1.75			
	MACH	.348	.359	.370	.383	.398			
	KIAS	208	207	206	205	205			
	FF/ENG	9711	9658	9610	9656	9795			
160	EPR	1.51	1.55	1.59	1.63	1.68	1.73		
	MACH	.333	.343	.354	.368	.382	.397		
	KIAS	199	198	197	197	197	197		
	FF/ENG	8698	8611	8561	8594	8661	8774		
140	EPR	1.46	1.49	1.53	1.57	1.62	1.66	1.72	1.77
	MACH	.315	.327	.339	.352	.366	.380	.396	.412
	KIAS	188	188	188	188	188	188	188	188
	FF/ENG	7680	7644	7621	7617	7635	7683	7769	7906
120	EPR	1.41	1.44	1.47	1.51	1.55	1.59	1.64	1.69
	MACH	.300	.311	.323	.335	.349	.362	.377	.392
	KIAS	179	179	179	179	179	179	179	179
	FF/ENG	6808	6763	6724	6700	6685	6689	6719	6777



**GEAR DOWN**

**ENGINE INOP**

**MAX CONTINUOUS THRUST**

**Long Range Cruise Diversion Fuel and Time  
 Ground to Air Miles Conversion**

AIR DISTANCE (NM)					GROUND DISTANCE (NM)	AIR DISTANCE (NM)				
HEADWIND COMPONENT (KTS)						TAILWIND COMPONENT (KTS)				
100	80	60	40	20	20	40	60	80	100	
171	151	133	120	109	100	94	88	82	78	74
346	304	268	241	219	200	187	174	164	155	147
523	459	405	362	329	300	280	262	246	232	220
702	615	541	484	439	400	373	349	328	309	293
881	771	677	606	549	500	466	436	409	386	366
1062	928	815	728	659	600	560	524	491	463	439
1245	1087	954	851	770	700	653	610	573	540	511
1429	1246	1091	974	880	800	746	697	654	616	583

**Reference Fuel and Time Required at Check Point**

AIR DIST (NM)	PRESSURE ALTITUDE (1000 FT)							
	6		10		14		18	
	FUEL (1000 LB)	TIME (HR:MIN)	FUEL (1000 LB)	TIME (HR:MIN)	FUEL (1000 LB)	TIME (HR:MIN)	FUEL (1000 LB)	TIME (HR:MIN)
100	4.4	0:29	4.0	0:28	3.6	0:27	3.3	0:26
200	9.0	0:55	8.3	0:53	7.8	0:51	7.5	0:48
300	13.6	1:21	12.6	1:18	12.0	1:14	11.6	1:11
400	18.0	1:48	16.9	1:43	16.1	1:38	15.6	1:33
500	22.5	2:14	21.0	2:09	20.1	2:02	19.6	1:55
600	26.8	2:41	25.2	2:34	24.0	2:26	23.5	2:18
700	31.1	3:08	29.2	3:00	27.9	2:50	27.3	2:41
800	35.4	3:36	33.2	3:26	31.8	3:15	31.0	3:04

**Fuel Required Adjustment (1000 LB)**

REFERENCE FUEL REQUIRED (1000 LB)	WEIGHT AT CHECK POINT (1000 LB)					
	160	180	200	220	240	260
5	-0.5	-0.3	0.0	0.3	0.7	1.0
10	-1.0	-0.5	0.0	0.8	1.5	2.3
15	-1.6	-0.8	0.0	1.2	2.4	3.5
20	-2.1	-1.1	0.0	1.6	3.2	4.7
25	-2.7	-1.4	0.0	2.0	4.0	6.0
30	-3.2	-1.6	0.0	2.5	4.9	7.3
35	-3.7	-1.9	0.0	2.9	5.7	8.5

Includes APU fuel burn.

**GEAR DOWN**

**ENGINE INOP**

**MAX CONTINUOUS THRUST**

**Holding  
Flaps Up**

WEIGHT (1000 LB)		PRESSURE ALTITUDE (FT)			
		1500	5000	10000	15000
240	EPR	1.60			
	KIAS	228			
	FF/ENG	13170			
220	EPR	1.56	1.63		
	KIAS	220	220		
	FF/ENG	12070	12120		
200	EPR	1.52	1.58	1.70	
	KIAS	213	213	213	
	FF/ENG	11030	11020	11200	
180	EPR	1.47	1.54	1.64	
	KIAS	205	205	205	
	FF/ENG	10050	10000	10050	
160	EPR	1.43	1.49	1.59	1.71
	KIAS	197	197	197	197
	FF/ENG	9100	9020	8990	9150
140	EPR	1.39	1.44	1.53	1.64
	KIAS	188	188	188	188
	FF/ENG	8190	8090	8000	8040
120	EPR	1.34	1.39	1.47	1.57
	KIAS	179	179	179	179
	FF/ENG	7280	7180	7060	7020

This table includes 5% additional fuel for holding in a racetrack pattern.

---

## **Introduction**

This chapter contains information to supplement performance data from the Flight Management Computer (FMC). In addition, sufficient inflight data is provided to complete a flight with the FMC inoperative. In the event of conflict between data presented in this chapter and that contained in the approved Airplane Flight Manual, the Flight Manual shall always take precedence.

---

## **General**

### **Takeoff Speeds**

The speeds presented in the Takeoff Speeds table can be used for all performance conditions except where adjustments must be made to V1 for clearway, stopway, antiskid inoperative, brakes deactivated, improved climb, contaminated runway situations, brake energy limits, or obstacle clearance with unbalanced V1. These speeds may be used for weights less than or equal to the performance limited weight.

Normal takeoff speeds, V1, VR, and V2, with anti-skid on and all brakes operative, are read from the table by entering with takeoff flap setting, brake release weight and appropriate column. The appropriate column is obtained by entering the Column Reference chart with the airport pressure altitude and the actual temperature or assumed temperature for reduced thrust takeoffs. Slope and wind adjustments to V1 are obtained by entering the V1 Adjustment chart. Adjusted V1 must not exceed VR. These takeoff speeds are not valid when the brake release weight is based on clearway, stopway, improved climb or is limited by tire speed or brake energy.

### **V1(MCG)**

Regulations prohibit scheduling takeoff with a V1 less than minimum V1 for control on the ground, V1(MCG). Therefore compare the adjusted V1 to the V1(MCG). To find V1(MCG) enter the V1(MCG) table with the airport pressure altitude and actual OAT. If the adjusted V1 is less than V1(MCG), set V1 equal to V1(MCG). If VR is less than V1(MCG), set VR equal to V1(MCG), and determine a new V2 by adding the difference between the normal VR and V1(MCG) to the normal V2. No takeoff weight adjustment is necessary provided that the actual field length exceeds the minimum field length.

---

## Clearway and Stopway V1 Adjustments

Takeoff speed adjustments are to be applied to V1 speed when using takeoff weights based on the use of clearway and stopway.

Adjust V1 speed by the amount shown in the table. The adjusted V1 speed must not exceed VR.

Maximum allowable clearway limits are provided for guidance when more precise data is not available.

### Stab Trim

To find takeoff stabilizer trim setting, enter Stab Trim Setting table with anticipated brake release weight and center of gravity (C.G. % MAC) and read required stabilizer trim units.

### VREF

The Reference Speed table contains flaps 30, 25 and 20 landing speeds for a given weight.

### Flap Maneuver Speeds

This table provides the flap speed schedule for minimum maneuver speeds. Using VREF as the basis for the schedule makes it variable as a function of weight and will provide adequate maneuver margin above stall at all weights.

During flap retraction/extension, movement of the flap to the next position should be initiated when within 20 knots of the recommended speed for that position.

### Slush/Standing Water Takeoff

Experience has shown that aircraft performance may deteriorate significantly on runways covered with snow, slush, standing water or ice. Therefore, reductions in runway/obstacle limited takeoff weight and revised takeoff speeds are necessary. The tables are intended for guidance in accordance with advisory material and assumes an engine failure at the critical point during the takeoff.

The entire runway is assumed to be completely covered by a contaminant of uniform thickness and density. Therefore this information is conservative when operating under typical colder weather conditions where patches of slush exist and some degree of sanding is common. Takeoffs in slush depths greater than 13mm (0.5 inches) are not recommended because of possible airplane damage as a result of slush

impingement on the airplane structure. The use of assumed temperature for reduced thrust is not allowed on contaminated runways. Interpolation for slush/standing water depths between the values shown is permitted.

Takeoff weight is determined as follows:

1. Determine the field/obstacle limit weight for the takeoff flap setting.
2. Enter the Weight Adjustment table with the field/obstacle limit weight to obtain the weight reduction for the slush/standing water depth and airport pressure altitude.
3. Adjust field length available for temperature by amount shown on table.
4. Enter the V1(MCG) Limit Weight table with the adjusted field length and pressure altitude to obtain the slush/standing water limit weight with respect to minimum field length required for V1(MCG) speed.

The maximum allowable takeoff weight in slush/standing water is the lesser of the limit weights found in steps 2 and 4.

Takeoff speed determination:

1. Determine takeoff speeds V1, VR and V2 for actual brake release weight using the Takeoff Speeds table in this section.
2. If V1(MCG) limited, set  $V1=V1(MCG)$ . If not limited by V1(MCG) considerations, enter the V1 Adjustment table with actual brake release weight to determine the V1 reduction to apply to V1 speed. If the adjusted V1 is less than V1(MCG), set  $V1=V1(MCG)$ . The adjusted V1 must not exceed VR.

## Slippery Runway Takeoff

Airplane braking action is reported as good, medium or poor, depending on existing runway conditions. If braking action is reported as good, conditions should not be expected to be as good as on clean, dry runways. The value “good” is comparative and is intended to mean that airplanes should not experience braking or directional control difficulties when stopping. Good reported braking action denotes wet runway conditions or runways covered by compact snow. Similarly, poor braking action denotes runways covered with wet ice. Performance is based on reversers operating and a 15 ft. screen height at the end of the runway. The tables provided are used in the same manner as the Slush/Standing Water tables.

## Anti-Skid Inoperative

When operating with anti-skid inoperative, the field limit weight and V1 must be reduced to account for the effect on accelerate-stop performance. A simplified method which conservatively accounts for the effects of anti-

**757 Flight Crew Operations Manual**

skid inoperative on a dry runway is to reduce the normal runway/obstacle limited weight by 28000 lb and the V1 associated with the reduced weight by the amount shown in the table below.

ANTI-SKID INOPERATIVE ADJUSTMENT				
FIELD LENGTH (FT)	V1 ADJUSTMENT (KTS)*			
	FLAPS 1	FLAPS 5	FLAPS 15	FLAPS 20
6000	-38	-33	-31	-29
8000	-29	-27	-26	-24
10000	-24	-23	-22	-19
12000	-20	-19	-18	
14000	-17	-16		

\*Reduce V1 adjustment by 1 knot per 10000 lb below 240000 lb.

If the resulting V1 is less than minimum V1, takeoff is permitted with V1 set equal to V1(MCG) provided the accelerate-stop distance corrected for wind and slope exceeds approximately 7000 ft.

Detailed analysis for the specific case from the Airplane Flight Manual may yield a less restrictive penalty.

**Brakes Deactivated**

When operating with brakes deactivated, the field and brake energy limit weights and the V1 and VMBE must be reduced to allow for reduced braking capability. A simplified method which conservatively accounts for the reduced braking capability of one brake deactivated is to reduce the normal runway/obstacle limited weight by 3600 lb and the V1 associated with the reduced weight by the amount shown in the table below.

ONE BRAKE DEACTIVATED SPEED ADJUSTMENT	
FIELD LENGTH (FT)	V1 ADJUSTMENT (KTS)
6000	-3
8000	-2
10000	-2
12000	-2
14000	-1

If the resulting V1 is less than minimum V1, takeoff is permitted with V1 set equal to V1(MCG) provided the accelerate-stop distance exceeds approximately 3800 ft for one brake deactivated.

**Takeoff EPR**

To find Max Takeoff EPR based on normal engine bleed for air conditioning packs on, enter Takeoff EPR table with airport pressure altitude and airport OAT and read EPR. EPR adjustments are shown for packs off and wing anti-ice on.

---

## Max Climb EPR

This table shows Max Climb EPR for a 250/290/.78 climb speed schedule, normal engine bleed for packs on and anti-ice off. Enter the table with airport pressure altitude and TAT and read EPR. EPR adjustments are shown for packs off and anti-ice operation.

## Go-around EPR

To find Max Go-around EPR based on normal engine bleed for packs on, enter the Go-Around EPR table with airport pressure altitude and reported OAT or TAT and read EPR. EPR adjustments are shown for packs off and wing anti-ice on.

## Flight with Unreliable Airspeed / Turbulent Air Penetration

Pitch attitude and average EPR information is provided for use in all phases of flight in the event of unreliable airspeed/Mach indications resulting from blocking or freezing of the pitot system. Loss of radome or turbulent air may also cause unreliable airspeed/Mach indications. The cruise table in this section may also be used for turbulent air penetration.

Pitch attitude is shown in bold type for emphasis since altitude and/or vertical speed indications may also be unreliable.

---

## All Engines

### Long Range Cruise Maximum Operating Altitude

These tables provide the maximum operating altitude in the same manner as the FMC. Maximum altitudes are shown for a given cruise weight and maneuver capability. Note that these tables consider both thrust and buffet limits, providing the more limiting of the two. Any data that is thrust limited is denoted by an asterisk and represents only a thrust limited condition in level flight with maximum cruise thrust at 0 ft/min residual rate of climb or maximum climb thrust at 100 ft/min residual rate of climb. Flying above these altitudes with sustained banks in excess of approximately 12° may cause the airplane to lose speed and/or altitude.

Note that optimum altitudes shown in the tables result in buffet related maneuver margins of 1.5g (48° bank) or more. The altitudes shown in the table are limited to the maximum certified altitude of 42000 ft.

### Long Range Cruise Control

These tables provide target EPR, Long Range Cruise Mach number, IAS and standard day fuel flow per engine for the airplane weight and pressure altitude. As indicated by the shaded area, at optimum altitude .80M approximates the Long Range Cruise Mach schedule.

---

## APU Operation During Flight

For APU operation during flight, increase fuel flow according to the table in the Engine Inoperative text section.

## Long Range Cruise Enroute Fuel and Time

Long Range Cruise Enroute Fuel and Time tables are provided to determine remaining time and fuel required to destination. The data is based on Long Range Cruise and .78/290/250 descent. Tables are presented for low altitudes and high altitudes.

To determine remaining fuel and time required, first enter the Ground to Air Miles Conversion table to convert ground distance and enroute wind to an equivalent still air distance for use with the Reference Fuel and Time tables. Next, enter the Reference Fuel and Time table with air distance from the Ground to Air Miles Conversion table and the desired altitude and read Reference Fuel and Time Required. Lastly, enter the Fuel Required Adjustment table with the Reference Fuel and the actual weight at checkpoint to obtain fuel required to destination.

## Long Range Cruise Wind-Altitude Trade

Wind is a factor which may justify operations considerably below optimum altitude. For example, a favorable wind component may have an effect on ground speed which more than compensates for the loss in air range.

Using this table, it is possible to determine the break-even wind (advantage necessary or disadvantage that can be tolerated) to maintain the same range at another altitude and long range cruise speed. The table makes no allowance for climb or descent time, fuel or distance, and is based on comparing ground fuel mileage.

## Descent

Distance and time for descent are shown for a .78/290/250 descent speed schedule. Enter the table with top of descent pressure altitude and read distance in nautical miles and time in minutes. Data is based on flight idle thrust descent in zero wind. Allowances are included for a straight-in approach with gear down and landing flaps at the outer marker.

## Holding

Target EPR, indicated airspeed and fuel flow per engine information is tabulated for holding with flaps up based on the FMC optimum holding speed schedule. This is the higher of the maximum endurance speed and the maneuvering speed. Small variations in airspeed will not appreciably affect the overall endurance time. Enter the table with weight and pressure altitude to read EPR, IAS and fuel flow per engine.



---

---

## Advisory Information

### Normal Configuration Landing Distance

Tables are provided as advisory information for normal configuration landing distance on dry runways and slippery runways with good, medium, and poor reported braking action. These values are actual landing distances and do not include the 1.67 regulatory factor. Therefore, they cannot be used to determine the dispatch required landing field length.

To use these tables, determine the reference landing distance for the selected braking configuration. Then adjust the reference distance for landing weight, altitude, wind, slope, temperature, approach speed, and the number of operative thrust reversers to obtain the actual landing distance.

When landing on slippery runways or runways contaminated with ice, snow, slush, or standing water, the reported braking action must be considered. If the surface is affected by water, snow, or ice and the braking action is reported as "good", conditions should not be expected to be as good as on clean, dry runways. The value "good" is comparative and is intended to mean that airplanes should not experience braking or directional control difficulties when landing. The performance level used to calculate the "good" data is consistent with wet runway testing done on early Boeing jets. The performance level used to calculate "poor" data reflects runways covered with wet ice.

Use of the autobrake system commands the airplane to a constant deceleration rate. In some conditions, such as a runway with "poor" braking action, the airplane may not be able to achieve these deceleration rates. In these cases, runway slope and inoperative reversers influence the stopping distance. Since it cannot be determined quickly when this becomes a factor, it is conservative to add the effects of slope and inoperative reversers when using the autobrake system.

### Non-normal Configuration Landing Distance

Advisory information is provided to support non-normal configurations that affect the landing performance of the airplane. Landing distances and adjustments are provided for dry runways and runways with good, medium, and poor reported braking action.

Enter the table with the applicable non-normal configuration and read the normal approach speed. The reference landing distance is a reference distance from 50 ft above the threshold to stop based on a reference landing weight and speed at sea level, zero wind, and zero slope. Subsequent columns provide adjustments for off-reference landing weight,

altitude, wind, slope, and speed conditions. Each adjustment is independently added to the reference landing distance. Landing distance includes the effects of max manual braking and reverse thrust.

## **Recommended Brake Cooling Schedule**

Advisory information is provided to assist in avoiding the problems associated with hot brakes. For normal operation, most landings are at weights below the AFM quick turnaround limit weight.

Use of the recommended cooling schedule will help avoid brake overheat and fuse plug problems that could result from repeated landings at short time intervals or a rejected takeoff.

Enter the Recommended Brake Cooling Schedule table with the airplane weight and brakes on speed, adjusted for wind, at the appropriate temperature and altitude condition. Instructions for applying wind adjustments are included below the table. Linear interpolation may be used to obtain intermediate values. The resulting number is the reference brake energy per brake in millions of foot-pounds, and represents the amount of energy absorbed by each brake during a rejected takeoff

To determine the energy per brake absorbed during landing, enter the appropriate Adjusted Brake Energy Per Brake table (No Reverse Thrust or Two Engine Reverse) with the reference brake energy per brake and the type of braking used during landing (Max Manual, Max Auto, or Autobrake). The resulting number is the adjusted brake energy per brake and represents the energy absorbed in each brake during the landing.

The recommended cooling time is found in the final table by entering with the adjusted brake energy per brake or brake temperature monitor system (BTMS) indication on EICAS. Times are provided for ground cooling and inflight gear down cooling.

If brake temperature monitor indication on EICAS is available, the hottest brake indication 10 to 15 minutes after the airplane has come to a complete stop, or inflight with gear retracted, may be used to determine the recommended cooling schedule by entering at the bottom of the chart. The brake temperature light illuminates when the hottest brake is registering 5 on the EICAS indication and extinguishes as the hottest brake cools with an EICAS indication of 4.

---

---

## Engine Inoperative

### Initial Max Continuous EPR

The Initial Max Continuous EPR setting for use following an engine failure is shown. The table shows a range of Cruise Mach numbers to provide a target EPR setting at the start of driftdown. Also shown is the maximum TAT at which the limit EPR can be set. Once driftdown is established, the Max Continuous EPR table should be used to determine EPR for the given conditions.

### Max Continuous EPR

Power setting is based on one engine operating with one A/C pack operating and all anti-ice bleeds off. Enter the table with pressure altitude and IAS or Mach to read EPR.

It is desirable to maintain engine thrust level within the limits of the Max Cruise thrust rating. However, where thrust level in excess of Max Cruise rating is required, such as for meeting terrain clearance, ATC altitude assignments, or to attain maximum range capability, it is permissible to use the thrust needed up to the Max Continuous thrust rating. The Max Continuous thrust rating is intended primarily for emergency use at the discretion of the pilot and is the maximum thrust that may be used continuously.

### Driftdown Speed/Level Off Altitude

The table shows optimum driftdown speed as a function of cruise weight at start of driftdown. Also shown are the approximate weight and pressure altitude at which the airplane will level off considering 100 ft/min residual rate of climb.

The level off altitude is dependent on air temperature (ISA deviation).

### Driftdown/LRC Range Capability

This table shows the range capability from the start of driftdown. Driftdown is continued to level off altitude. As weight decreases due to fuel burn, the airplane is accelerated to Long Range Cruise speed. Cruise is continued at level off altitude and Long Range Cruise speed.

To determine fuel required, enter the Ground to Air Miles Conversion table with the desired ground distance and adjust for anticipated winds to obtain air distance to destination. Then enter the Driftdown/Cruise Fuel and Time table with air distance and weight at start of driftdown to determine fuel

and time required. If altitudes other than the level off altitude are used, fuel and time required may be obtained by using the Engine Inoperative Long Range Cruise Enroute Fuel and Time table.

### Long Range Cruise Altitude Capability

The table shows the maximum altitude that can be maintained at a given weight and air temperature (ISA deviation), based on Long Range Cruise speed, Max Continuous thrust, and 100 ft/min residual rate of climb.

### Long Range Cruise Control

The table provides target EPR, engine inoperative Long Range Cruise Mach number, IAS and fuel flow for the airplane weight and pressure altitude. The fuel flow values in this table reflect single engine fuel burn.

### APU Operation During Flight

For APU operation during flight, increase fuel flow according to the following table. These increments include the APU fuel flow and the effect of increased drag from the APU door.

PRESSURE ALTITUDE (1000 FT)	APU FUEL FLOW (LB/HR)
39	160
35	160
31	190
25	210
20	230
15	240
10	280
5	300

### Long Range Cruise Diversion Fuel and Time

Tables are provided for crews to determine the fuel and time required to proceed to an alternate airfield with one engine inoperative. The data is based on single engine Long Range Cruise speed and .78/290/250 descent. Enter with Air Distance as determined from the Ground to Air Miles Conversion table and read Fuel and Time required at the cruise pressure altitude. Adjust the fuel obtained for deviation from the reference weight at checkpoint as required by entering the Fuel Required Adjustment table with the fuel required for the reference weight and the actual weight at checkpoint.

### Holding

Single engine holding data is provided in the same format as the all engine holding data and is based on the same assumptions.

---

---

## Alternate Thrust Setting

### Introduction

This section contains performance data for airplane operation using %N1 as an alternate method to set thrust. The data includes engine bleed effects for normal air conditioning operation; i.e., two packs on at normal flow, all engines operating, and one pack on at normal flow with one engine inoperative.

### Takeoff Performance

A simplified method which conservatively accounts for the effects of using %N1 as an alternate thrust setting is to reduce the normal limit weights. The Takeoff Performance table provides takeoff field, tire speed, climb and obstacle limit weight adjustments. To determine limit weight for operations with alternate thrust setting, enter the table with takeoff flap setting and apply the weight reduction to the normal full rate limit weight. The most limiting of the takeoff weights must be used.

Improved climb performance procedure and reduced thrust operation using assumed temperature method is not permitted. Derate 1 and Derate 2 operation is not permitted.

### Takeoff Speeds

Takeoff speeds for the reduced weights should be adjusted by the amount shown in the Takeoff Speeds table. The adjusted V1 should not exceed the adjusted VR.

NOTE: The FMC does not incorporate alternate thrust setting performance in its takeoff speeds calculations.

### Enroute Performance

The Enroute Performance table provides the weight adjustment that must be applied to the enroute climb limit weight when using %N1 as an alternate thrust setting.

### Landing Performance

The Landing Performance table provides the weight adjustment that must be applied to the Approach/Landing Climb limit weight. Enter the table with the appropriate flap setting and apply the weight reduction to the normal full rate limit weight. The alternate thrust setting Approach/Landing Climb limit must be compared to the Landing Field Length limit and the most limiting of the two be used as the landing limit weight.

---

## Takeoff %N1/Go-around %N1

Takeoff and Go-around power setting are presented for normal air conditioning bleed. Max Takeoff or Go-around %N1 may be read directly from the tables for the desired pressure altitude and airport OAT.

Thrust protection is not provided in the alternate thrust setting and maximum rated thrust is reached at a thrust lever position less than full forward. As a result, thrust overboost can occur at full forward thrust lever positions.

### Max Climb %N1

This table shows Max Climb %N1 for a 250/290/.78 climb speed schedule, normal engine bleed for packs on and anti-ice off. Enter the table with airport pressure altitude and TAT and read %N1. %N1 adjustments are shown for packs off and anti-ice operation.

### Max Cruise %N1

Maximum Cruise %N1 is presented for .80M, which approximates Long Range Cruise speed. The table is based on normal air conditioning bleed, 2 bleeds/2 packs on. Enter the table with pressure altitude and TAT to read Max Cruise %N1. Appropriate bleed adjustments are shown.

---

## Alternate Thrust Setting, Engine Inoperative

### Initial Max Continuous %N1

The Initial Max Continuous %N1 setting, with normal engine bleed for packs on and anti-ice off, following engine failure in cruise is shown for .80M and a range of altitudes and TAT.

### Max Continuous %N1

Max Continuous %N1 which can be set during engine out cruise conditions is presented. Enter the appropriate table with pressure altitude, TAT, and KIAS to obtain Maximum Continuous %N1. Intermediate airspeeds may be interpolated. Appropriate bleed adjustments are shown.

---

## Gear Down

This section contains performance for airplane operation with the landing gear extended for all phases of flight. The data is based on engine bleeds for normal air conditioning.

NOTE: The Flight Management Computer System (FMCS) does not contain special provisions for operation with landing gear extended. As a result, the FMCS will generate inaccurate enroute speed schedules, display

---

non-conservative predictions of fuel burn, estimated time of arrival (ETA), maximum altitude, and compute overly shallow descent path. To obtain accurate ETA predictions, gear down cruise speed and altitude should be entered on the CLB and CRZ pages. Gear down cruise speed should also be entered on the DES page and a STEP SIZE of zero should be entered on the PERF INIT or CRZ page. Use of the VNAV during descent under these circumstances is not recommended.

Tables for gear down performance in this section are identical in format and used in the same manner as tables for the gear up configuration previously described.

Intentionally  
Blank



**757-200 PW2037 LB FAA**

**General ..... PI.20.1**

- Takeoff Speeds ..... PI.20.1
- V1(MCG) ..... PI.20.2
- Maximum Allowable Clearway ..... PI.20.2
- Clearway and Stopway V1 Adjustments ..... PI.20.2
- Stab Trim Setting ..... PI.20.2
- VREF (KIAS) ..... PI.20.3
- Flap Maneuver Speeds ..... PI.20.4
- Slush/Standing Water Takeoff ..... PI.20.5
- Slippery Runway Takeoff ..... PI.20.7
- Takeoff EPR ..... PI.20.11
- Assumed Temperature Reduced Thrust ..... PI.20.11
- TO1 Takeoff Speeds ..... PI.20.12
- TO1 V1(MCG) ..... PI.20.12
- TO1 Slush/Standing Water Takeoff ..... PI.20.13
- TO1 Slippery Runway Takeoff ..... PI.20.15
- TO1 Takeoff EPR ..... PI.20.17
- TO2 Takeoff Speeds ..... PI.20.18
- TO2 V1(MCG) ..... PI.20.18
- TO2 Slush/Standing Water Takeoff ..... PI.20.19
- TO2 Slippery Runway Takeoff ..... PI.20.21
- TO2 Takeoff EPR ..... PI.20.23
- Max Climb EPR ..... PI.20.24
- Go-around EPR ..... PI.20.25
- Flight With Unreliable Airspeed / Turbulent Air Penetration PI.20.26

**All Engine ..... PI.21.1**

- Long Range Cruise Maximum Operating Altitude ..... PI.21.1
- Long Range Cruise Control ..... PI.21.2
- Long Range Cruise Enroute Fuel and Time - Low Altitudes . PI.21.3

---

Long Range Cruise Enroute Fuel and Time - High Altitudes . . . . .	PI.21.4
Long Range Cruise Wind-Altitude Trade . . . . .	PI.21.4
Descent at .78/290/250 . . . . .	PI.21.5
Holding . . . . .	PI.21.5
<b>Advisory Information . . . . .</b>	<b>PI.22.1</b>
Normal Configuration Landing Distance . . . . .	PI.22.1
Non-Normal Configuration Landing Distance . . . . .	PI.22.3
Recommended Brake Cooling Schedule. . . . .	PI.22.11
<b>Engine Inoperative . . . . .</b>	<b>PI.23.1</b>
Initial Max Continuous EPR . . . . .	PI.23.1
Max Continuous EPR . . . . .	PI.23.2
Driftdown Speed/Level Off Altitude. . . . .	PI.23.4
Driftdown/LRC Cruise Range Capability . . . . .	PI.23.4
Long Range Cruise Altitude Capability . . . . .	PI.23.5
Long Range Cruise Control . . . . .	PI.23.6
Long Range Cruise Diversion Fuel and Time. . . . .	PI.23.7
Holding . . . . .	PI.23.8
<b>Alternate Thrust Setting. . . . .</b>	<b>PI.24.1</b>
Takeoff Performance . . . . .	PI.24.1
Takeoff Speeds . . . . .	PI.24.1
Enroute Performance. . . . .	PI.24.1
Landing Performance . . . . .	PI.24.1
Takeoff %N1 . . . . .	PI.24.2
Go-around %N1 . . . . .	PI.24.3
Max Climb %N1 . . . . .	PI.24.4
Max Cruise %N1. . . . .	PI.24.5
<b>Alternate Thrust Setting, Engine Inoperative . . . . .</b>	<b>PI.24.6</b>
Initial Max Continuous %N1 . . . . .	PI.24.6
Max Continuous %N1. . . . .	PI.24.7

---

<b>Gear Down</b> .....	<b>PI.25.1</b>
210 KIAS Max Climb EPR .....	PI.25.1
Long Range Cruise Altitude Capability .....	PI.25.1
Long Range Cruise Control .....	PI.25.2
Long Range Cruise Enroute Fuel and Time .....	PI.25.3
Descent at VREF30+80 .....	PI.25.3
Holding .....	PI.25.4
<b>Gear Down, Engine Inoperative</b> .....	<b>PI.26.1</b>
Driftdown Speed/Level Off Altitude .....	PI.26.1
Long Range Cruise Altitude Capability .....	PI.26.1
Long Range Cruise Control .....	PI.26.2
Long Range Cruise Diversion Fuel and Time .....	PI.26.3
Holding .....	PI.26.4
<b>Text</b> .....	<b>PI.27.1</b>
Introduction .....	PI.27.1
General .....	PI.27.1
All Engines .....	PI.27.5
Advisory Information .....	PI.27.7
Engine Inoperative .....	PI.27.9
Alternate Thrust Setting .....	PI.27.11
Alternate Thrust Setting, Engine Inoperative .....	PI.27.12
Gear Down .....	PI.27.12

Intentionally  
Blank

**Performance Inflight**  
**General**

**Chapter PI**  
**Section 20**

**Takeoff Speeds**  
**Max Takeoff Thrust**

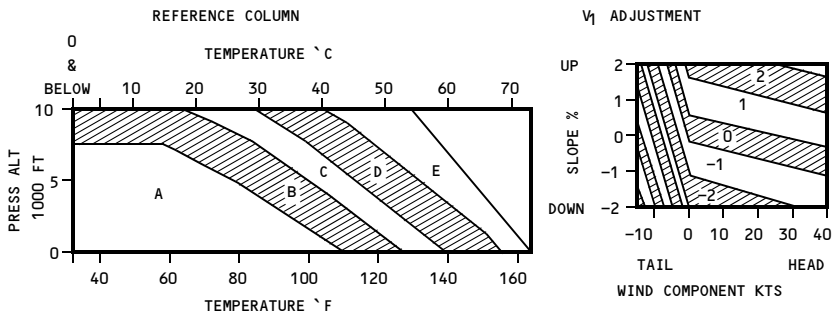

FLAPS	WEIGHT (1000 LB)	A			B			C			D			E		
		V1	VR	V2	V1	VR	V2	V1	VR	V2	V1	VR	V2	V1	VR	V2
1	260	180	183	185	182	185	186									
	240	171	174	177	173	176	177									
	220	162	165	169	164	167	169	166	169	170						
	200	153	155	161	155	157	161	157	159	161	159	162	162			
	180	143	145	153	145	148	153	147	150	153	149	152	153	152	154	154
	160	132	135	144	134	137	144	136	139	144	138	141	144	141	144	144
5	260	165	168	171	167	169	170									
	240	157	160	163	159	161	163									
	220	149	152	155	151	153	156	153	155	156						
	200	140	143	148	142	145	148	144	147	148						
	180	131	134	140	133	136	140	135	138	140	137	140	141			
	160	121	124	132	123	126	132	125	128	132	127	130	132	130	133	133
15	260	157	160	161												
	240	149	152	154												
	220	141	144	147	143	146	147									
	200	133	136	140	134	138	140	136	140	141						
	180	124	127	133	126	129	133	128	131	133	130	133	133			
	160	115	119	125	117	120	125	118	122	126	120	124	126	122	126	126
20	260	147	150	152												
	240	140	143	146												
	220	133	136	140												
	200	125	128	133	127	130	133									
	180	117	120	126	119	122	126	120	123	127						
	160	108	112	119	110	113	119	111	115	119	113	117	119			

**V1(MCG)**

**Max Takeoff Thrust**

ACTUAL OAT		PRESSURE ALTITUDE (FT)					
°F	°C	0	2000	4000	6000	8000	10000
131	55	88					
122	50	92	88				
113	45	95	91	88	85		
104	40	97	94	91	88	84	
95	35	99	96	94	90	87	83
86	30	101	98	96	92	89	85
77	25	101	100	98	94	91	87
68	20	101	100	99	96	92	89
59	15	101	100	99	97	94	90
50 & BELOW	10 & BELOW	102	101	99	97	95	92

**Maximum Allowable Clearway**

FIELD LENGTH (FT)	MAX ALLOWABLE CLEARWAY FOR V1 REDUCTION (FT)
4000	350
6000	450
8000	550
10000	650
12000	700
14000	750

**Clearway and Stopway V1 Adjustments**

CLEARWAY MINUS STOPWAY (FT)	NORMAL V1 (KIAS)			
	120	140	160	180
800	-5	-4	-2	-1
600	-4	-3	-2	-1
400	-3	-2	-1	-1
200	-1	-1	-1	0
0	0	0	0	0
-200	1	1	1	0
-400	3	2	1	1
-600	4	3	2	1
-800	5	4	2	1

**Stab Trim Setting**

WEIGHT (1000 LB)	C.G. %MAC						
	9	14	19	24	29	34	39
260	7	7	6	5	4 1/4	3 1/4	2 1/2
240	7	6 3/4	5 3/4	4 3/4	4	3 1/4	2 1/2
220	7	6 1/4	5 1/4	4 1/2	3 3/4	3 1/4	2 1/2
200	7	6	5	4 1/4	3 1/2	3	2 1/4
180	6 1/2	5 1/2	4 1/2	4	3 1/4	2 3/4	2 1/4
160	6 1/4	5 1/4	4 1/4	3 3/4	3	2 1/2	2

---

**VREF (KIAS)**

WEIGHT (1000 LB)	FLAPS		
	30	25	20
260	155	157	165
240	148	150	158
220	140	142	151
200	133	135	144
180	125	127	136
160	117	119	128
140	109	111	119

---

## Flap Maneuver Speeds

FLAP POSITION	MANEUVER SPEED
UP	VREF30 + 80
1	VREF30 + 60
5	VREF30 + 40
15	VREF30 + 20
20	VREF30 + 20
25	VREF25
30	VREF30



**ADVISORY INFORMATION**

**Slush/Standing Water Takeoff**

**Maximum Reverse Thrust**

**Weight Adjustment (1000 LB)**

FIELD/ OBSTACLE LIMIT WEIGHT (1000 LB)	SLUSH/STANDING WATER DEPTH								
	0.12 INCHES (3 mm)			0.25 INCHES (6 mm)			0.50 INCHES (13 mm)		
	PRESS ALT (FT)			PRESS ALT (FT)			PRESS ALT (FT)		
	S.L.	4000	8000	S.L.	4000	8000	S.L.	4000	8000
280	-29.0	-29.2	-30.6	-33.0	-33.8	-33.5	-45.8	-42.3	-38.5
260	-26.7	-27.0	-28.8	-31.0	-32.0	-32.5	-42.8	-41.5	-39.5
240	-24.3	-24.7	-27.0	-28.3	-30.0	-31.2	-39.2	-39.9	-40.2
220	-21.2	-21.8	-24.5	-24.6	-26.8	-28.6	-33.4	-36.4	-38.5
200	-17.6	-18.2	-21.0	-20.2	-22.6	-24.9	-27.0	-30.7	-34.6
180	-13.9	-14.5	-17.3	-15.5	-18.0	-20.8	-20.8	-24.0	-29.3
160	-10.2	-10.9	-13.9	-10.5	-13.2	-16.8	-14.8	-17.0	-23.3

**V1(MCG) Limit Weight (1000 LB)**

ADJUSTED FIELD LENGTH (FT)	SLUSH/STANDING WATER DEPTH								
	0.12 INCHES (3 mm)			0.25 INCHES (6 mm)			0.50 INCHES (13 mm)		
	PRESS ALT (FT)			PRESS ALT (FT)			PRESS ALT (FT)		
	S.L.	4000	8000	S.L.	4000	8000	S.L.	4000	8000
3800	129.8			139.2			156.8		
4200	173.2	120.4		183.0	133.9		198.9	153.2	122.1
4600	217.2	155.8		226.8	168.7	130.9	240.0	187.2	149.7
5000	262.4	191.1	146.2	270.7	203.5	160.0	281.0	221.3	177.2
5400	307.6	228.1	176.9	314.5	238.3	189.1		255.3	205.0
5800		266.0	207.6		273.0	218.2		289.4	233.6
6200		303.9	238.0		307.8	247.3			262.1
6600			268.3			276.4			290.7
7000			298.6			305.5			319.3

1. Enter Weight Adjustment table with slush/standing water depth and field/obstacle limit weight to obtain slush/standing water weight adjustment.
2. Adjust field length available by -100 ft /+100 ft for every 10°F above/below 40°F.
3. Find V1(MCG) limit weight for adjusted field length and pressure altitude.
4. Max allowable slush/standing water limited weight is lesser of weights from 1 and 3.

**V1 Adjustment (KIAS)**

WEIGHT (1000 LB)	SLUSH/STANDING WATER DEPTH								
	0.12 INCHES (3 mm)			0.25 INCHES (6 mm)			0.50 INCHES (13 mm)		
	PRESS ALT (FT)			PRESS ALT (FT)			PRESS ALT (FT)		
	S.L.	4000	8000	S.L.	4000	8000	S.L.	4000	8000
260	-13	-13	-13	-8	-10	-10	-1	-6	-10
240	-14	-14	-13	-9	-10	-10	-1	-5	-8
220	-15	-15	-14	-11	-10	-10	-2	-3	-6
200	-16	-16	-14	-12	-11	-10	-3	-2	-4
180	-17	-16	-15	-13	-12	-11	-5	-3	-2
160	-17	-17	-15	-15	-13	-12	-9	-6	-2

1. Obtain V1, VR and V2 for the actual weight.
2. If V1(MCG) limited, set V1 = V1(MCG). If not V1(MCG) limited, enter V1 Adjustment table with the actual weight to obtain V1 speed adjustment. If adjusted V1 is less than V1(MCG), set V1 = V1(MCG). V1 not to exceed VR.

**ADVISORY INFORMATION**

**Slush/Standing Water Takeoff**

**No Reverse Thrust**

**Weight Adjustment (1000 LB)**

FIELD/ OBSTACLE LIMIT WEIGHT (1000 LB)	SLUSH/STANDING WATER DEPTH								
	0.12 INCHES (3 mm)			0.25 INCHES (6 mm)			0.50 INCHES (13 mm)		
	PRESS ALT (FT)			PRESS ALT (FT)			PRESS ALT (FT)		
	S.L.	4000	8000	S.L.	4000	8000	S.L.	4000	8000
280	-39.9	-42.7	-45.5	-43.6	-46.4	-49.2	-56.7	-60.7	-64.7
260	-37.3	-40.1	-42.9	-42.4	-45.2	-48.0	-54.8	-58.8	-62.8
240	-33.7	-36.5	-39.3	-38.9	-41.7	-44.5	-50.6	-54.6	-58.6
220	-29.4	-32.2	-35.0	-34.0	-36.8	-39.6	-44.6	-48.6	-52.6
200	-24.7	-27.5	-30.3	-28.4	-31.2	-34.0	-37.3	-41.3	-45.3
180	-19.9	-22.7	-25.5	-22.7	-25.5	-28.3	-29.1	-33.1	-37.1
160	-15.4	-18.2	-21.0	-17.7	-20.5	-23.3	-20.5	-24.5	-28.5

**V1(MCG) Limit Weight (1000 LB)**

ADJUSTED FIELD LENGTH (FT)	SLUSH/STANDING WATER DEPTH								
	0.12 INCHES (3 mm)			0.25 INCHES (6 mm)			0.50 INCHES (13 mm)		
	PRESS ALT (FT)			PRESS ALT (FT)			PRESS ALT (FT)		
	S.L.	4000	8000	S.L.	4000	8000	S.L.	4000	8000
4600							124.0		
5000							170.4		
5400	133.0			172.2			219.0	124.0	
5800	198.0			230.3			266.9	170.4	
6200	259.9	133.0		281.3	172.2		311.4	219.0	124.0
6600	308.7	198.0			230.3			266.9	170.4
7000		259.9	133.0		281.3	172.2		311.4	219.0
7400		308.7	198.0			230.3			266.9
7800			259.9			281.3			311.4
8200			308.7						

1. Enter Weight Adjustment table with slush/standing water depth and field/obstacle limit weight to obtain slush/standing water weight adjustment.
2. Adjust field length available by -135 ft/+135 ft for every 5°C above/below 4°C.
3. Find V1(MCG) limit weight for adjusted field length and pressure altitude.
4. Max allowable slush/standing water limited weight is lesser of weights from 1 and 3.

**V1 Adjustment (KIAS)**

WEIGHT (1000 LB)	SLUSH/STANDING WATER DEPTH								
	0.12 INCHES (3 mm)			0.25 INCHES (6 mm)			0.50 INCHES (13 mm)		
	PRESS ALT (FT)			PRESS ALT (FT)			PRESS ALT (FT)		
	S.L.	4000	8000	S.L.	4000	8000	S.L.	4000	8000
280	-19	-19	-19	-13	-13	-13	-5	-1	0
260	-21	-21	-21	-14	-14	-14	-3	0	0
240	-22	-22	-22	-16	-16	-16	-3	0	0
220	-24	-24	-24	-17	-17	-17	-3	0	0
200	-25	-25	-25	-19	-19	-19	-5	-1	0
180	-26	-26	-26	-21	-21	-21	-8	-4	0
160	-26	-26	-26	-23	-23	-23	-12	-8	-4

1. Obtain V1, VR and V2 for the actual weight.
2. If V1(MCG) limited, set V1 = V1(MCG). If not V1(MCG) limited, enter V1 Adjustment table with the actual weight to obtain V1 speed adjustment. If adjusted V1 is less than V1(MCG), set V1 = V1(MCG). V1 not to exceed VR.

**Slippery Runway Takeoff**  
**Maximum Reverse Thrust**  
**Weight Adjustment (1000 LB)**

FIELD/ OBSTACLE LIMIT WEIGHT (1000 LB)	REPORTED BRAKING ACTION								
	GOOD			MEDIUM			POOR		
	PRESS ALT (FT)			PRESS ALT (FT)			PRESS ALT (FT)		
	S.L.	4000	8000	S.L.	4000	8000	S.L.	4000	8000
280	-0.4	-0.8	-1.2	-13.5	-13.9	-14.3	-23.8	-24.4	-25.0
260	-2.4	-2.8	-3.2	-14.1	-14.5	-14.9	-23.1	-23.7	-24.3
240	-3.1	-3.5	-3.9	-13.7	-14.1	-14.5	-21.6	-22.2	-22.8
220	-3.0	-3.4	-3.8	-12.5	-12.9	-13.3	-19.4	-20.0	-20.6
200	-2.3	-2.7	-3.1	-10.7	-11.1	-11.5	-16.8	-17.4	-18.0
180	-1.4	-1.8	-2.2	-8.8	-9.2	-9.6	-13.9	-14.5	-15.1
160	-0.6	-1.0	-1.4	-6.8	-7.2	-7.6	-10.8	-11.4	-12.0

**V1(MCG) Limit Weight (1000 LB)**

ADJUSTED FIELD LENGTH (FT)	REPORTED BRAKING ACTION								
	GOOD			MEDIUM			POOR		
	PRESS ALT (FT)			PRESS ALT (FT)			PRESS ALT (FT)		
	S.L.	4000	8000	S.L.	4000	8000	S.L.	4000	8000
3000	137.4								
3400	204.9								
3800	270.4	171.4		129.9					
4200		237.9	137.4	176.9					
4600		302.4	204.9	226.4	153.3				
5000			270.4	278.1	201.3	129.9	149.7		
5400					252.1	176.9	180.6		
5800					304.3	226.4	213.5	142.1	
6200						278.1	248.5	172.7	
6600							285.3	205.1	134.5
7000								239.5	165.0
7400								276.0	196.8
7800								313.3	230.7
8200									266.7
8600									304.0

1. Enter Weight Adjustment table with reported braking action and field/obstacle limit weight to obtain slippery runway weight adjustment.
2. Adjust "Good" field length available by -80 ft/+80 ft for every 10°F above/below 40°F. Adjust "Medium" field length available by -80 ft/+80 ft for every 10°F above/below 40°F. Adjust "Poor" field length available by -100 ft/+100 ft for every 10°F above/below 40°F.
3. Find V1(MCG) limit weight for adjusted field length and pressure altitude.
4. Max allowable slippery runway limited weight is lesser of weights from 1 and 3.

**Slippery Runway Takeoff**  
**Maximum Reverse Thrust**  
**V1 Adjustment (KIAS)**

WEIGHT (1000 LB)	REPORTED BRAKING ACTION								
	GOOD			MEDIUM			POOR		
	PRESS ALT (FT)			PRESS ALT (FT)			PRESS ALT (FT)		
	S.L.	4000	8000	S.L.	4000	8000	S.L.	4000	8000
260	-6	-5	-4	-12	-11	-10	-21	-19	-17
240	-6	-5	-4	-15	-14	-13	-24	-22	-20
220	-7	-6	-5	-16	-15	-14	-27	-25	-23
200	-8	-7	-6	-18	-17	-16	-29	-27	-25
180	-8	-7	-6	-19	-18	-17	-30	-28	-26
160	-9	-8	-7	-20	-19	-18	-31	-29	-27

1. Obtain V1, VR and V2 for the actual weight.
2. If V1(MCG) limited, set V1 = V1(MCG). If not V1(MCG) limited, enter V1 Adjustment table with the actual weight to obtain V1 speed adjustment. If adjusted V1 is less than V1(MCG), set V1 = V1(MCG). V1 not to exceed VR.

**Slippery Runway Takeoff**  
**No Reverse Thrust**  
**Weight Adjustment (1000 LB)**

FIELD/ OBSTACLE LIMIT WEIGHT (1000 LB)	REPORTED BRAKING ACTION								
	GOOD			MEDIUM			POOR		
	PRESS ALT (FT)			PRESS ALT (FT)			PRESS ALT (FT)		
	S.L.	4000	8000	S.L.	4000	8000	S.L.	4000	8000
280	-0.4	-1.2	-2.0	-21.2	-22.0	-22.8	-39.3	-40.5	-41.7
260	-4.3	-5.1	-5.9	-22.6	-23.4	-24.2	-37.6	-38.8	-40.0
240	-6.2	-7.0	-7.8	-22.5	-23.3	-24.1	-35.2	-36.4	-37.6
220	-6.5	-7.3	-8.1	-21.1	-21.9	-22.7	-32.1	-33.3	-34.5
200	-5.7	-6.5	-7.3	-18.7	-19.5	-20.3	-28.1	-29.3	-30.5
180	-4.5	-5.3	-6.1	-15.8	-16.6	-17.4	-22.8	-24.0	-25.2
160	-3.2	-4.0	-4.8	-12.7	-13.5	-14.3	-16.2	-17.4	-18.6

**V1(MCG) Limit Weight (1000 LB)**

ADJUSTED FIELD LENGTH (FT)	REPORTED BRAKING ACTION								
	GOOD			MEDIUM			POOR		
	PRESS ALT (FT)			PRESS ALT (FT)			PRESS ALT (FT)		
	S.L.	4000	8000	S.L.	4000	8000	S.L.	4000	8000
3400	133.8								
3800	228.8	144.7							
4200		237.1	155.6						
4600			245.6						
5400				193.3					
5800				273.9	157.3				
6200					243.2	120.5			
6600					318.1	210.4			
7000						288.7			
8200							159.8		
8600							220.6		
9000							269.8	133.2	
9400							304.9	189.0	
9800								248.1	
10200								287.6	159.8
10600									220.6
11000									269.8
11400									304.9

1. Enter Weight Adjustment table with reported braking action and field/obstacle limit weight to obtain slippery runway weight adjustment.
2. Adjust "Good" field length available by -100 ft/+100 ft for every 10°F above/below 40°F.  
 Adjust "Medium" field length available by -100 ft/+100 ft for every 10°F above/below 40°F.  
 Adjust "Poor" field length available by -160 ft/+160 ft for every 10°F above/below 40°F.
3. Find V1(MCG) limit weight for adjusted field length and pressure altitude.
4. Max allowable slippery runway limited weight is lesser of weights from 1 and 3.

**Slippery Runway Takeoff**

**No Reverse Thrust**

**V1 Adjustment (KIAS)**

WEIGHT (1000 LB)	REPORTED BRAKING ACTION								
	GOOD			MEDIUM			POOR		
	PRESS ALT (FT)			PRESS ALT (FT)			PRESS ALT (FT)		
	S.L.	4000	8000	S.L.	4000	8000	S.L.	4000	8000
280	-1	0	0	-9	-5	-1	-29	-25	-21
260	-5	-1	0	-14	-10	-6	-32	-28	-24
240	-7	-3	0	-18	-14	-10	-36	-32	-28
220	-9	-5	-1	-22	-18	-14	-41	-37	-33
200	-10	-6	-2	-24	-20	-16	-44	-40	-36
180	-10	-6	-2	-26	-22	-18	-47	-43	-39
160	-11	-7	-3	-28	-24	-20	-49	-45	-41

1. Obtain V1, VR and V2 for the actual weight.
2. If V1(MCG) limited, set V1 = V1(MCG). If not V1(MCG) limited, enter V1 Adjustment table with the actual weight to obtain V1 speed adjustment. If adjusted V1 is less than V1(MCG), set V1 = V1(MCG). V1 not to exceed VR.

**Takeoff EPR**

**Based on engine bleed for packs on and anti-ice off**

AIRPORT OAT		AIRPORT PRESSURE ALTITUDE (FT)							
°F	°C	0	1000	2000	3000	4000	5000	6000	8000
158	70	1.20	1.21	1.21	1.22	1.22	1.23	1.23	1.23
149	65	1.24	1.24	1.24	1.24	1.24	1.24	1.24	1.24
140	60	1.26	1.26	1.26	1.26	1.26	1.26	1.26	1.26
131	55	1.28	1.28	1.28	1.28	1.28	1.28	1.28	1.28
122	50	1.32	1.32	1.32	1.32	1.32	1.32	1.32	1.32
113	45	1.35	1.35	1.35	1.35	1.35	1.35	1.35	1.35
104	40	1.37	1.38	1.38	1.39	1.39	1.39	1.39	1.39
95	35	1.39	1.40	1.41	1.41	1.42	1.43	1.43	1.43
86	30	1.41	1.42	1.43	1.44	1.45	1.45	1.45	1.45
77	25	1.41	1.43	1.45	1.47	1.48	1.49	1.49	1.49
68	20	1.41	1.43	1.45	1.47	1.49	1.51	1.52	1.52
59	15	1.41	1.43	1.45	1.47	1.49	1.51	1.53	1.55
50 & BELOW	10 & BELOW	1.41	1.43	1.45	1.47	1.49	1.51	1.53	1.56

**EPR Adjustments for Engine Bleeds**

BLEED CONFIGURATION	AIRPORT PRESSURE ALTITUDE (FT)							
	0	1000	2000	3000	4000	5000	6000	8000
PACKS OFF	0.01	0.01	0.01	0.01	0.01	0.01	0.01	0.01
WING ANTI-ICE ON	-0.02	-0.02	-0.02	-0.02	-0.02	-0.02	-0.02	-0.02

**Assumed Temperature Reduced Thrust**

**Based on 25% thrust reduction**

MINIMUM ALLOWABLE EPR FOR REDUCED THRUST	
MAX TAKEOFF EPR FOR ACTUAL OAT	MIN TAKEOFF EPR ALLOWED
1.60	1.38
1.55	1.36
1.50	1.33
1.45	1.30
1.40	1.27
1.35	1.24
1.30	1.20

757 Flight Crew Operations Manual

**TO1 Takeoff Speeds**

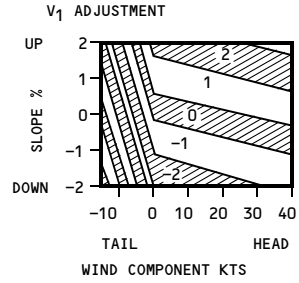
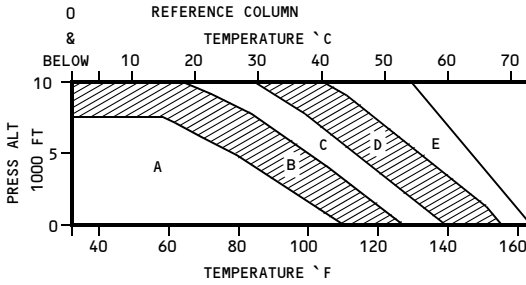

FLAPS	WEIGHT (1000 LB)	A			B			C			D			E		
		V1	VR	V2	V1	VR	V2	V1	VR	V2	V1	VR	V2	V1	VR	V2
1	260	184	184	186	186	186	187									
	240	174	175	178	176	177	178									
	220	164	166	170	166	168	170	168	170	171						
	200	155	157	162	156	159	162	159	161	162	161	163	163			
	180	145	147	154	147	149	154	149	151	154	151	153	154	154	156	156
	160	134	137	145	136	139	145	138	141	145	140	143	145	144	146	146
5	260	167	168	172	169	171	172									
	240	159	161	164	161	163	164									
	220	151	153	156	153	155	157	155	157	157						
	200	141	143	149	144	146	149	146	149	149						
	180	133	135	141	135	137	141	137	140	141	139	142	142			
	160	123	126	133	125	128	133	127	130	133	129	132	133	132	135	135
15	260	159	161	162												
	240	151	153	155												
	220	143	145	148	145	147	148									
	200	135	137	141	137	139	141	139	141	142						
	180	126	129	134	128	131	134	130	132	134	132	134	134			
	160	117	120	126	119	122	126	121	123	127	122	125	127	125	127	127
20	260	150	153	154												
	240	142	145	147												
	220	134	137	141												
	200	127	130	134	129	132	134									
	180	119	122	127	121	123	127	122	125	128						
	160	111	114	118	112	115	120	114	117	120	115	118	120			

**TO1 V1(MCG)**

ACTUAL OAT		PRESSURE ALTITUDE (FT)					
°F	°C	0	2000	4000	6000	8000	10000
122	50	88	85				
104	40	93	90	87			
86	30	96	94	91	88	85	81
68	20	96	95	94	92	88	84
50	10	97	95	94	92	90	87
32 & BELOW	0 & BELOW	97	95	95	93	91	88



**TO1 Slush/Standing Water Takeoff**

**Maximum Reverse Thrust**

**Weight Adjustment (1000 LB)**

TO FIELD/OBSTACLE LIMIT WEIGHT (1000 LB)	SLUSH/STANDING WATER DEPTH								
	0.12 INCHES (3 mm)			0.25 INCHES (6 mm)			0.50 INCHES (13 mm)		
	PRESS ALT (FT)			PRESS ALT (FT)			PRESS ALT (FT)		
	S.L.	4000	8000	S.L.	4000	8000	S.L.	4000	8000
280	-29.4	-29.2	-29.0	-34.8	-33.3	-31.3	-48.6	-44.3	-37.0
260	-27.3	-28.0	-28.8	-32.5	-32.6	-32.2	-45.5	-44.4	-40.7
240	-24.7	-26.1	-27.6	-29.6	-30.9	-31.7	-41.5	-42.7	-42.1
220	-21.7	-23.6	-25.5	-26.1	-28.2	-29.9	-36.4	-39.3	-41.2
200	-18.3	-20.3	-22.5	-22.0	-24.5	-26.8	-30.4	-34.2	-37.9
180	-14.4	-16.3	-18.5	-17.2	-19.7	-22.4	-23.4	-27.3	-32.4
160	-10.2	-11.6	-13.7	-11.9	-13.8	-16.7	-15.3	-18.7	-24.5

**V1(MCG) Limit Weight (1000 LB)**

ADJUSTED FIELD LENGTH (FT)	SLUSH/STANDING WATER DEPTH								
	0.12 INCHES (3 mm)			0.25 INCHES (6 mm)			0.50 INCHES (13 mm)		
	PRESS ALT (FT)			PRESS ALT (FT)			PRESS ALT (FT)		
	S.L.	4000	8000	S.L.	4000	8000	S.L.	4000	8000
3400				120.7			134.3		
3800	156.6			163.9			175.6	133.1	
4200	201.7	146.8		208.3	154.9		218.4	167.6	133.9
4600	248.8	183.9	141.3	254.5	191.5	150.0	263.2	203.0	162.8
5000	298.0	222.4	172.9	302.7	229.3	181.0	310.1	239.5	192.5
5400		262.5	205.4		268.6	212.8		277.4	223.4
5800		304.1	238.8		309.2	245.6		316.4	255.4
6200			273.3			279.3			288.9
6600			308.7			313.8			

1. Enter Weight Adjustment table with slush/standing water depth and TO1 field/obstacle limit weight to obtain slush/standing water adjustment.
2. Adjust field length available by -100 ft/+100 ft for every 10°F above/below 40°F.
3. Find V1(MCG) limit weight for adjusted field length and pressure altitude.
4. Max allowable slush/standing water limited weight is lesser of weights from 1 and 3.

**V1 Adjustment (KIAS)**

WEIGHT (1000 LB)	SLUSH/STANDING WATER DEPTH								
	0.12 INCHES (3 mm)			0.25 INCHES (6 mm)			0.50 INCHES (13 mm)		
	PRESS ALT (FT)			PRESS ALT (FT)			PRESS ALT (FT)		
	S.L.	4000	8000	S.L.	4000	8000	S.L.	4000	8000
260	-9	-9	-8	-7	-7	-7	-1	-4	-4
240	-11	-11	-10	-7	-7	-7	0	-2	-4
220	-12	-12	-11	-8	-8	-8	0	-1	-3
200	-13	-13	-12	-9	-9	-8	0	0	-2
180	-14	-14	-13	-11	-10	-9	-2	0	0
160	-15	-15	-14	-12	-11	-10	-5	-2	0

1. Obtain V1, VR and V2 for the actual weight.
2. If V1(MCG) limited, set V1 = V1(MCG). If not V1(MCG) limited, enter V1 Adjustment table with the actual weight to obtain V1 speed adjustment. If adjusted V1 is less than V1(MCG), set V1 = V1(MCG). V1 not to exceed VR.

**TO1 Slush/Standing Water Takeoff**

**No Reverse Thrust**

**Weight Adjustment (1000 LB)**

TO1 FIELD/OBSTACLE LIMIT WEIGHT (1000 LB)	SLUSH/STANDING WATER DEPTH								
	0.12 INCHES (3 mm)			0.25 INCHES (6 mm)			0.50 INCHES (13 mm)		
	PRESS ALT (FT)			PRESS ALT (FT)			PRESS ALT (FT)		
	S.L.	4000	8000	S.L.	4000	8000	S.L.	4000	8000
280	-45.3	-48.1	-50.9	-49.7	-52.5	-55.3	-58.5	-63.3	-68.1
260	-40.9	-43.7	-46.5	-46.0	-48.8	-51.6	-57.5	-62.3	-67.1
240	-36.3	-39.1	-41.9	-41.7	-44.5	-47.3	-54.7	-59.5	-64.3
220	-31.4	-34.2	-37.0	-36.6	-39.4	-42.2	-48.6	-53.4	-58.2
200	-26.4	-29.2	-32.0	-30.7	-33.5	-36.3	-40.4	-45.2	-50.0
180	-21.3	-24.1	-26.9	-24.5	-27.3	-30.1	-31.2	-36.0	-40.8
160	-16.3	-19.1	-21.9	-18.2	-21.0	-23.8	-22.3	-27.1	-31.9

**V1(MCG) Limit Weight (1000 LB)**

ADJUSTED FIELD LENGTH (FT)	SLUSH/STANDING WATER DEPTH								
	0.12 INCHES (3 mm)			0.25 INCHES (6 mm)			0.50 INCHES (13 mm)		
	PRESS ALT (FT)			PRESS ALT (FT)			PRESS ALT (FT)		
	S.L.	4000	8000	S.L.	4000	8000	S.L.	4000	8000
4600							162.7		
5000	139.1			174.3			213.6	125.8	
5400	209.0			233.4	128.3		266.8	175.2	
5800	271.9	157.3		290.6	189.3			226.7	138.1
6200		225.3			247.9	143.8		280.3	187.9
6600		287.1	175.1		304.9	204.2			239.9
7000			241.2			262.1			293.8
7400			302.3			319.2			

1. Enter Weight Adjustment table with slush/standing water depth and TO1 field/obstacle limit weight to obtain slush/standing water weight adjustment.
2. Adjust field length available by -120 ft /+120 ft for every 10°F above/below 40°F.
3. Find V1(MCG) limit weight for adjusted field length and pressure altitude.
4. Max allowable slush/standing water limited weight is lesser of weights from 1 and 3.

**V1 Adjustment (KIAS)**

WEIGHT (1000 LB)	SLUSH/STANDING WATER DEPTH								
	0.12 INCHES (3 mm)			0.25 INCHES (6 mm)			0.50 INCHES (13 mm)		
	PRESS ALT (FT)			PRESS ALT (FT)			PRESS ALT (FT)		
	S.L.	4000	8000	S.L.	4000	8000	S.L.	4000	8000
280	-14	-14	-14	-7	-7	-7	-9	-7	-5
260	-16	-16	-16	-9	-9	-9	-5	-3	-1
240	-18	-18	-18	-11	-11	-11	-2	0	0
220	-20	-20	-20	-13	-13	-13	0	0	0
200	-22	-22	-22	-15	-15	-15	-1	0	0
180	-23	-23	-23	-17	-17	-17	-3	-1	0
160	-24	-24	-24	-19	-19	-19	-7	-5	-3

1. Obtain V1, VR and V2 for the actual weight.
2. If V1(MCG) limited, set V1 = V1(MCG). If not V1(MCG) limited, enter V1 Adjustment table with the actual weight to obtain V1 speed adjustment. If adjusted V1 is less than V1(MCG), set V1 = V1(MCG). V1 not to exceed VR.

### TO1 Slippery Runway Takeoff

#### Maximum Reverse Thrust

#### Weight Adjustment (1000 LB)

TO1 FIELD/OBSTACLE LIMIT WEIGHT (1000 LB)	REPORTED BRAKING ACTION								
	GOOD			MEDIUM			POOR		
	PRESS ALT (FT)			PRESS ALT (FT)			PRESS ALT (FT)		
	S.L.	4000	8000	S.L.	4000	8000	S.L.	4000	8000
280	-0.9	-1.3	-1.7	-14.2	-14.6	-15.0	-25.0	-25.6	-26.2
260	-2.8	-3.2	-3.6	-14.7	-15.1	-15.5	-24.0	-24.6	-25.2
240	-3.4	-3.8	-4.2	-14.1	-14.5	-14.9	-22.3	-22.9	-23.5
220	-3.2	-3.6	-4.0	-12.8	-13.2	-13.6	-20.1	-20.7	-21.3
200	-2.5	-2.9	-3.3	-11.0	-11.4	-11.8	-17.4	-18.0	-18.6
180	-1.6	-2.0	-2.4	-9.1	-9.5	-9.9	-14.4	-15.0	-15.6
160	-0.9	-1.3	-1.7	-7.2	-7.6	-8.0	-11.4	-12.0	-12.6

### V1(MCG) Limit Weight (1000 LB)

ADJUSTED FIELD LENGTH (FT)	REPORTED BRAKING ACTION								
	GOOD			MEDIUM			POOR		
	PRESS ALT (FT)			PRESS ALT (FT)			PRESS ALT (FT)		
	S.L.	4000	8000	S.L.	4000	8000	S.L.	4000	8000
3000	163.4								
3400	229.8	129.0							
3800	292.2	197.2		153.4					
4200		261.4	163.4	203.2	128.7				
4600			229.8	254.3	178.2		136.8		
5000			292.2	306.4	228.6	153.4	169.3		
5400					280.3	203.2	203.0	136.8	
5800						254.3	238.8	169.3	
6200						306.4	276.9	203.0	136.8
6600							316.5	238.8	169.3
7000								276.9	203.0
7400								316.5	238.8
7800									276.9
8200									316.5

1. Enter Weight Adjustment table with reported braking action and TO1 field/obstacle limit weight to obtain slippery runway weight adjustment.
2. Adjust "Good" field length available by -80 ft/+80 ft for every 10°F above/below 40°F.  
Adjust "Medium" field length available by -80 ft/+80 ft for every 10°F above/below 40°F.  
Adjust "Poor" field length available by -100 ft/+100 ft for every 10°F above/below 40°F.
3. Find V1(MCG) limit weight for adjusted field length and pressure altitude.
4. Max allowable slippery runway limited weight is lesser of weights from 1 and 3.

### V1 Adjustment (KIAS)

WEIGHT (1000 LB)	REPORTED BRAKING ACTION								
	GOOD			MEDIUM			POOR		
	PRESS ALT (FT)			PRESS ALT (FT)			PRESS ALT (FT)		
	S.L.	4000	8000	S.L.	4000	8000	S.L.	4000	8000
260	-4	-3	-2	-10	-9	-8	-17	-15	-13
240	-5	-4	-3	-12	-11	-10	-20	-18	-16
220	-6	-5	-4	-14	-13	-12	-23	-21	-19
200	-7	-6	-5	-16	-15	-14	-25	-23	-21
180	-7	-6	-5	-17	-16	-15	-27	-25	-23
160	-8	-7	-6	-18	-17	-16	-29	-27	-25

1. Obtain V1, VR and V2 for the actual weight.
2. If V1(MCG) limited, set V1 = V1(MCG). If not V1(MCG) limited, enter V1 Adjustment table with the actual weight to obtain V1 speed adjustment. If adjusted V1 is less than V1(MCG), set V1 = V1(MCG). V1 not to exceed VR.

**TO1 Slippery Runway Takeoff**

**No Reverse Thrust**

**Weight Adjustment (1000 LB)**

TO1 FIELD/OBSTACLE LIMIT WEIGHT (1000 LB)	REPORTED BRAKING ACTION								
	GOOD			MEDIUM			POOR		
	PRESS ALT (FT)			PRESS ALT (FT)			PRESS ALT (FT)		
	S.L.	4000	8000	S.L.	4000	8000	S.L.	4000	8000
280	-4.4	-5.2	-6.0	-25.0	-25.8	-26.6	-42.9	-44.1	-45.3
260	-5.8	-6.6	-7.4	-24.3	-25.1	-25.9	-39.8	-41.0	-42.2
240	-6.8	-7.6	-8.4	-23.3	-24.1	-24.9	-36.6	-37.8	-39.0
220	-7.1	-7.9	-8.7	-21.8	-22.6	-23.4	-33.1	-34.3	-35.5
200	-6.6	-7.4	-8.2	-19.6	-20.4	-21.2	-29.3	-30.5	-31.7
180	-5.4	-6.2	-7.0	-16.9	-17.7	-18.5	-25.2	-26.4	-27.6
160	-3.4	-4.2	-5.0	-13.6	-14.4	-15.2	-20.8	-22.0	-23.2

**V1(MCG) Limit Weight (1000 LB)**

ADJUSTED FIELD LENGTH (FT)	REPORTED BRAKING ACTION								
	GOOD			MEDIUM			POOR		
	PRESS ALT (FT)			PRESS ALT (FT)			PRESS ALT (FT)		
	S.L.	4000	8000	S.L.	4000	8000	S.L.	4000	8000
3400	181.6								
3800	267.7	198.5	120.5						
4200		286.6	215.0						
4600			305.5						
5000				176.3					
5400				257.5	149.3				
5800					233.7	120.1			
6200					313.2	209.7			
6600						289.3			
7800							180.8		
8200							236.3		
8600							280.1	160.7	
9000								221.3	
9400								267.4	138.7
9800								309.9	205.0
10200									254.6
10600									297.2

1. Enter Weight Adjustment table with reported braking action and TO1 field/obstacle limit weight to obtain slippery runway weight adjustment.
2. Adjust "Good" field length available by -90 ft/+90 ft for every 10°F above/below 40°F.  
Adjust "Medium" field length available by -90 ft/+90 ft for every 10°F above/below 40°F.  
Adjust "Poor" field length available by -150 ft/+150 ft for every 10°F above/below 40°F.
3. Find V1(MCG) limit weight for adjusted field length and pressure altitude.
4. Max allowable slippery runway limited weight is lesser of weights from 1 and 3.

### TO1 Slippery Runway Takeoff

No Reverse Thrust

V1 Adjustment (KIAS)

WEIGHT (1000 LB)	REPORTED BRAKING ACTION								
	GOOD			MEDIUM			POOR		
	PRESS ALT (FT)			PRESS ALT (FT)			PRESS ALT (FT)		
	S.L.	4000	8000	S.L.	4000	8000	S.L.	4000	8000
280	0	0	0	-7	-5	-3	-21	-19	-17
260	-3	-1	0	-12	-10	-8	-26	-24	-22
240	-5	-3	-1	-16	-14	-12	-31	-29	-27
220	-8	-6	-4	-19	-17	-15	-35	-33	-31
200	-9	-7	-5	-22	-20	-18	-39	-37	-35
180	-10	-8	-6	-25	-23	-21	-42	-40	-38
160	-10	-8	-6	-27	-25	-23	-45	-43	-41

1. Obtain V1, VR and V2 for the actual weight.
2. If V1(MCG) limited, set V1 = V1(MCG). If not V1(MCG) limited, enter V1 Adjustment table with the actual weight to obtain V1 speed adjustment. If adjusted V1 is less than V1(MCG), set V1 = V1(MCG). V1 not to exceed VR.

### TO1 Takeoff EPR

Based on engine bleed for packs on, engine anti-ice on or off and wing anti-ice off

AIRPORT OAT		AIRPORT PRESSURE ALTITUDE (FT)							
°F	°C	0	1000	2000	3000	4000	5000	6000	8000
131	55	1.26	1.26	1.25	1.25	1.25	1.24	1.24	1.23
122	50	1.28	1.28	1.28	1.28	1.28	1.27	1.27	1.27
113	45	1.31	1.31	1.31	1.31	1.31	1.31	1.30	1.30
104	40	1.33	1.33	1.34	1.34	1.34	1.34	1.34	1.34
95	35	1.35	1.35	1.36	1.36	1.37	1.37	1.37	1.37
86	30	1.36	1.38	1.38	1.39	1.39	1.40	1.40	1.40
77	25	1.36	1.38	1.39	1.41	1.42	1.42	1.42	1.42
68	20	1.36	1.38	1.39	1.41	1.43	1.44	1.45	1.45
59	15	1.36	1.38	1.39	1.41	1.43	1.44	1.45	1.47
50 & BELOW	10 & BELOW	1.36	1.38	1.39	1.41	1.43	1.44	1.45	1.48

### EPR Adjustments for Engine Bleeds

BLEED CONFIGURATION	AIRPORT PRESSURE ALTITUDE (FT)							
	0	1000	2000	3000	4000	5000	6000	8000
PACKS OFF	0.01	0.01	0.01	0.01	0.01	0.01	0.01	0.01
WING ANTI-ICE ON	-0.02	-0.02	-0.02	-0.02	-0.02	-0.02	-0.02	-0.02

757 Flight Crew Operations Manual

**TO2 Takeoff Speeds**

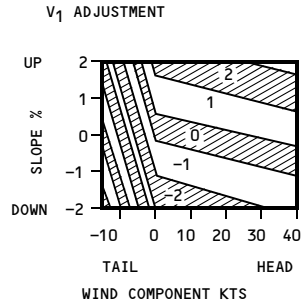
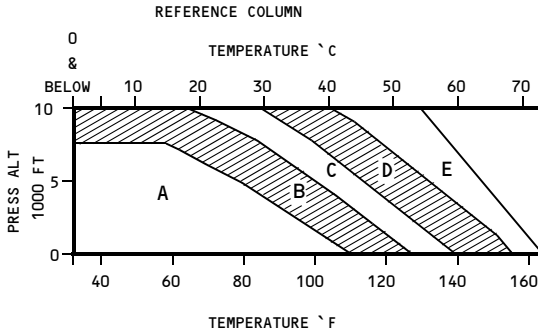

FLAPS	WEIGHT (1000 LB)	A			B			C			D			E		
		V1	VR	V2	V1	VR	V2	V1	VR	V2	V1	VR	V2	V1	VR	V2
1	240	176	177	178	178	179	179									
	220	166	168	170	169	170	170	171	172	172						
	200	157	158	162	159	161	162	161	162	162	163	165	163			
	180	147	149	154	149	151	154	151	153	154	154	155	154	156	157	157
5	240	161	163	164	163	164	164									
	220	153	155	156	155	156	157	157	158	158						
	200	144	146	149	147	148	149	149	150	150						
	180	135	137	141	137	139	141	139	141	141	141	143	143			
15	240	154	155	155												
	220	146	147	148	147	149	149									
	200	138	139	141	139	141	141	141	143	143						
	180	129	130	134	130	132	134	132	134	134	134	136	136			
20	240	144	146	147												
	220	137	139	141												
	200	129	131	134	132	133	134									
	180	121	123	127	123	125	127	124	127	128						
32 & BELOW	0 & BELOW	113	115	118	114	117	120	116	118	120	118	120	120			

**TO2 V1(MCG)**

ACTUAL OAT		PRESSURE ALTITUDE (FT)					
°F	°C	0	2000	4000	6000	8000	10000
122	50	86	82				
104	40	90	87	84	82	78	
86	30	93	91	88	85	82	79
68	20	93	92	91	88	85	82
50	10	93	92	91	89	87	84
32 & BELOW	0 & BELOW	94	93	91	89	87	84

**TO2 Slush/Standing Water Takeoff**

**Maximum Reverse Thrust  
 Weight Adjustment (1000 LB)**

TO2 FIELD/OBSTACLE LIMIT WEIGHT (1000 LB)	SLUSH/STANDING WATER DEPTH								
	0.12 INCHES (3 mm)			0.25 INCHES (6 mm)			0.50 INCHES (13 mm)		
	PRESS ALT (FT)			PRESS ALT (FT)			PRESS ALT (FT)		
	S.L.	4000	8000	S.L.	4000	8000	S.L.	4000	8000
280	-30.0	-33.0	-36.0	-31.6	-34.6	-37.6	-53.0	-56.0	-59.0
260	-28.4	-31.4	-34.4	-31.9	-34.9	-37.9	-49.6	-52.6	-55.6
240	-26.2	-29.2	-32.2	-30.7	-33.7	-36.7	-45.0	-48.0	-51.0
220	-23.3	-26.3	-29.3	-28.1	-31.1	-34.1	-39.3	-42.3	-45.3
200	-19.8	-22.8	-25.8	-24.1	-27.1	-30.1	-32.3	-35.3	-38.3
180	-15.6	-18.6	-21.6	-18.7	-21.7	-24.7	-24.2	-27.2	-30.2
160	-10.7	-13.7	-16.7	-12.0	-15.0	-18.0	-14.8	-17.8	-20.8

**V1(MCG) Limit Weight (1000 LB)**

ADJUSTED FIELD LENGTH (FT)	SLUSH/STANDING WATER DEPTH								
	0.12 INCHES (3 mm)			0.25 INCHES (6 mm)			0.50 INCHES (13 mm)		
	PRESS ALT (FT)			PRESS ALT (FT)			PRESS ALT (FT)		
	S.L.	4000	8000	S.L.	4000	8000	S.L.	4000	8000
3400	123.1			130.4			142.5		
3800	169.3			175.9			184.9	130.3	
4200	217.9	155.3		223.5	162.0		231.1	171.8	
4600	269.3	203.0	141.4	273.8	209.0	148.4	281.7	216.8	159.1
5000		253.6	188.4		258.5	194.6		266.3	202.9
5400		306.0	238.1		309.4	243.3		317.7	250.9
5800			290.3			294.1			302.3

1. Enter Weight Adjustment table with slush/standing water depth and TO2 field/obstacle limit weight to obtain slush/standing water adjustment.
2. Adjust field length available by -80 ft/+80 ft for every 10°F above/below 40°F.
3. Find V1(MCG) limit weight for adjusted field length and pressure altitude.
4. Max allowable slush/standing water limited weight is lesser of weights from 1 and 3.

**V1 Adjustment (KIAS)**

WEIGHT (1000 LB)	SLUSH/STANDING WATER DEPTH								
	0.12 INCHES (3 mm)			0.25 INCHES (6 mm)			0.50 INCHES (13 mm)		
	PRESS ALT (FT)			PRESS ALT (FT)			PRESS ALT (FT)		
	S.L.	4000	8000	S.L.	4000	8000	S.L.	4000	8000
260	-6	-4	-2	-3	-1	1	0	0	0
240	-8	-6	-4	-4	-2	0	0	0	0
220	-10	-8	-6	-5	-3	-1	0	0	0
200	-11	-9	-7	-7	-5	-3	0	0	0
180	-12	-10	-8	-8	-6	-4	0	0	0
160	-13	-11	-9	-10	-8	-6	-2	0	0

1. Obtain V1, VR and V2 for the actual weight.
2. If V1(MCG) limited, set V1 = V1(MCG). If not V1(MCG) limited, enter V1 Adjustment table with the actual weight to obtain V1 speed adjustment. If adjusted V1 is less than V1(MCG), set V1 = V1(MCG). V1 not to exceed VR.

**TO2 Slush/Standing Water Takeoff**

**No Reverse Thrust**

**Weight Adjustment (1000 LB)**

TO2 FIELD/OBSTACLE LIMIT WEIGHT (1000 LB)	SLUSH/STANDING WATER DEPTH								
	0.12 INCHES (3 mm)			0.25 INCHES (6 mm)			0.50 INCHES (13 mm)		
	PRESS ALT (FT)			PRESS ALT (FT)			PRESS ALT (FT)		
	S.L.	4000	8000	S.L.	4000	8000	S.L.	4000	8000
280	-50.7	-53.7	-56.7	-56.6	-59.6	-62.6	-73.2	-81.2	-89.2
260	-44.8	-47.8	-50.8	-50.8	-53.8	-56.8	-64.8	-72.8	-80.8
240	-39.0	-42.0	-45.0	-45.0	-48.0	-51.0	-56.5	-64.5	-72.5
220	-33.3	-36.3	-39.3	-38.8	-41.8	-44.8	-48.2	-56.2	-64.2
200	-27.8	-30.8	-33.8	-32.5	-35.5	-38.5	-39.9	-47.9	-55.9
180	-22.4	-25.4	-28.4	-25.9	-28.9	-31.9	-31.6	-39.6	-47.6
160	-17.1	-20.1	-23.1	-19.1	-22.1	-25.1	-23.3	-31.3	-39.3

**V1(MCG) Limit Weight (1000 LB)**

ADJUSTED FIELD LENGTH (FT)	SLUSH/STANDING WATER DEPTH								
	0.12 INCHES (3 mm)			0.25 INCHES (6 mm)			0.50 INCHES (13 mm)		
	PRESS ALT (FT)			PRESS ALT (FT)			PRESS ALT (FT)		
	S.L.	4000	8000	S.L.	4000	8000	S.L.	4000	8000
4200							141.3		
4600	121.7			156.2			195.0		
5000	195.6			217.5	123.5		280.9	166.1	
5400	260.5	159.7		274.0	187.6			230.8	141.3
5800		229.0	121.7		246.2	156.2			195.0
6200		291.1	195.6		301.7	217.5			280.9
6600			260.5			274.0			

1. Enter Weight Adjustment table with slush/standing water depth and TO2 field/obstacle limit weight to obtain slush/standing water adjustment.
2. Adjust field length available by -100 ft/+100 ft for every 10°F above/below 40°F.
3. Find V1(MCG) limit weight for adjusted field length and pressure altitude.
4. Max allowable slush/standing water limited weight is lesser of weights from 1 and 3.

**V1 Adjustment (KIAS)**

WEIGHT (1000 LB)	SLUSH/STANDING WATER DEPTH								
	0.12 INCHES (3 mm)			0.25 INCHES (6 mm)			0.50 INCHES (13 mm)		
	PRESS ALT (FT)			PRESS ALT (FT)			PRESS ALT (FT)		
	S.L.	4000	8000	S.L.	4000	8000	S.L.	4000	8000
280	-8	-6	-4	-4	-2	0	0	0	0
260	-11	-9	-7	-6	-4	-2	0	0	0
240	-14	-12	-10	-8	-6	-4	0	0	0
220	-17	-15	-13	-10	-8	-6	0	0	0
200	-19	-17	-15	-12	-10	-8	0	0	0
180	-21	-19	-17	-14	-12	-10	-1	0	0
160	-22	-20	-18	-17	-15	-13	-6	0	0

1. Obtain V1, VR and V2 for the actual weight.
2. If V1(MCG) limited, set V1 = V1(MCG). If not V1(MCG) limited, enter V1 Adjustment table with the actual weight to obtain V1 speed adjustment. If adjusted V1 is less than V1(MCG), set V1 = V1(MCG). V1 not to exceed VR.



## TO2 Slippery Runway Takeoff

### Maximum Reverse Thrust

### Weight Adjustment (1000 LB)

TO2 FIELD/OBSTACLE LIMIT WEIGHT (1000 LB)	REPORTED BRAKING ACTION								
	GOOD			MEDIUM			POOR		
	PRESS ALT (FT)			PRESS ALT (FT)			PRESS ALT (FT)		
	S.L.	4000	8000	S.L.	4000	8000	S.L.	4000	8000
280	0.0	0.0	-0.7	-13.5	-14.2	-14.9	-28.0	-28.8	-29.7
260	-1.3	-2.0	-2.7	-14.7	-15.3	-16.0	-27.1	-27.9	-28.8
240	-2.6	-3.3	-4.0	-14.9	-15.6	-16.3	-25.6	-26.4	-27.3
220	-3.1	-3.8	-4.5	-14.3	-15.0	-15.7	-23.5	-24.4	-25.2
200	-2.9	-3.5	-4.2	-12.9	-13.6	-14.2	-20.9	-21.7	-22.5
180	-1.8	-2.5	-3.2	-10.6	-11.2	-11.9	-17.6	-18.5	-19.3
160	-0.1	-0.8	-1.4	-7.4	-8.1	-8.7	-13.8	-14.6	-15.5

### V1(MCG) Limit Weight (1000 LB)

ADJUSTED FIELD LENGTH (FT)	REPORTED BRAKING ACTION								
	GOOD			MEDIUM			POOR		
	PRESS ALT (FT)			PRESS ALT (FT)			PRESS ALT (FT)		
	S.L.	4000	8000	S.L.	4000	8000	S.L.	4000	8000
3000	178.7								
3400	248.5	185.5	124.9						
3800		255.6	192.4	163.2					
4200			262.8	215.6	153.3				
4600				274.5	204.7	143.6	137.8		
5000					262.3	194.0	170.7		
5400						250.2	205.8	150.7	
5800						311.1	243.5	184.5	131.3
6200							283.7	220.5	164.0
6600								259.4	198.6
7000								299.8	235.7
7400									275.6
7800									316.0

1. Enter Weight Adjustment table with reported braking action and TO2 field/obstacle limit weight to obtain slippery runway weight adjustment.
2. Adjust "Good" field length available by -60 ft/+60 ft for every 10°F above/below 40°F.  
 Adjust "Medium" field length available by -60 ft/+60 ft for every 10°F above/below 40°F.  
 Adjust "Poor" field length available by -90 ft/+90 ft for every 10°F above/below 40°F.
3. Find V1(MCG) limit weight for adjusted field length and pressure altitude.
4. Max allowable slippery runway limited weight is lesser of weights from 1 and 3.

### V1 Adjustment (KIAS)

WEIGHT (1000 LB)	REPORTED BRAKING ACTION								
	GOOD			MEDIUM			POOR		
	PRESS ALT (FT)			PRESS ALT (FT)			PRESS ALT (FT)		
	S.L.	4000	8000	S.L.	4000	8000	S.L.	4000	8000
260	0	0	0	0	0	0	-10	-8	-6
240	-3	-1	0	-6	-4	-2	-13	-11	-9
220	-4	-2	0	-10	-8	-6	-17	-15	-13
200	-5	-3	-1	-12	-10	-8	-20	-18	-16
180	-6	-4	-2	-14	-12	-10	-23	-21	-19
160	-6	-4	-2	-15	-13	-11	-25	-23	-21

1. Obtain V1, VR and V2 for the actual weight.
2. If V1(MCG) limited, set V1 = V1(MCG). If not V1(MCG) limited, enter V1 Adjustment table with the actual weight to obtain V1 speed adjustment. If adjusted V1 is less than V1(MCG), set V1 = V1(MCG). V1 not to exceed VR.

**TO2 Slippery Runway Takeoff**  
**No Reverse Thrust**  
**Weight Adjustment (1000 LB)**

TO2 FIELD/OBSTACLE LIMIT WEIGHT (1000 LB)	REPORTED BRAKING ACTION								
	GOOD			MEDIUM			POOR		
	PRESS ALT (FT)			PRESS ALT (FT)			PRESS ALT (FT)		
	S.L.	4000	8000	S.L.	4000	8000	S.L.	4000	8000
280	-5.6	-6.4	-7.2	-26.5	-27.3	-28.1	-45.2	-46.8	-48.4
260	-6.5	-7.3	-8.1	-25.4	-26.2	-27.0	-41.7	-43.3	-44.9
240	-7.1	-7.9	-8.7	-24.1	-24.9	-25.7	-38.1	-39.7	-41.3
220	-7.2	-8.0	-8.8	-22.3	-23.1	-23.9	-34.3	-35.9	-37.5
200	-6.7	-7.5	-8.3	-20.0	-20.8	-21.6	-30.1	-31.7	-33.3
180	-5.7	-6.5	-7.3	-17.3	-18.1	-18.9	-25.8	-27.4	-29.0
160	-4.2	-5.0	-5.8	-14.2	-15.0	-15.8	-21.1	-22.7	-24.3

**V1(MCG) Limit Weight (1000 LB)**

ADJUSTED FIELD LENGTH (FT)	REPORTED BRAKING ACTION								
	GOOD			MEDIUM			POOR		
	PRESS ALT (FT)			PRESS ALT (FT)			PRESS ALT (FT)		
	S.L.	4000	8000	S.L.	4000	8000	S.L.	4000	8000
3400	210.6	143.9							
3800	297.6	231.5	167.7						
4200		320.0	253.0						
4600				137.5					
5000				224.4	122.5				
5400				315.3	211.9				
5800					301.3	199.6			
6200						287.3			
7400							175.9		
7800							232.2		
8200							274.3	163.3	
8600							313.7	222.2	
9000								266.4	150.8
9400								305.8	211.5
9800									258.6
10200									298.0

1. Enter Weight Adjustment table with reported braking action and TO2 field/obstacle limit weight to obtain slippery runway weight adjustment.
2. Adjust "Good" field length available by -65 ft/+65 ft for every 10°F above/below 40°F.  
Adjust "Medium" field length available by -65 ft/+65 ft for every 10°F above/below 40°F.  
Adjust "Poor" field length available by -135 ft/+135 ft for every 10°F above/below 40°F.
3. Find V1(MCG) limit weight for adjusted field length and pressure altitude.
4. Max allowable slippery runway limited weight is lesser of weights from 1 and 3.

## TO2 Slippery Runway Takeoff

No Reverse Thrust

V1 Adjustment (KIAS)

WEIGHT (1000 LB)	REPORTED BRAKING ACTION								
	GOOD			MEDIUM			POOR		
	PRESS ALT (FT)			PRESS ALT (FT)			PRESS ALT (FT)		
	S.L.	4000	8000	S.L.	4000	8000	S.L.	4000	8000
280	0	0	0	0	0	0	-8	-4	0
260	-2	0	0	-6	-2	0	-16	-12	-8
240	-4	0	0	-11	-7	-3	-23	-19	-15
220	-6	-2	0	-16	-12	-8	-30	-26	-22
200	-8	-4	0	-20	-16	-12	-35	-31	-27
180	-9	-5	-1	-23	-19	-15	-39	-35	-31
160	-10	-6	-2	-25	-21	-17	-43	-39	-35

1. Obtain V1, VR and V2 for the actual weight.
2. If V1(MCG) limited, set V1 = V1(MCG). If not V1(MCG) limited, enter V1 Adjustment table with the actual weight to obtain V1 speed adjustment. If adjusted V1 is less than V1(MCG), set V1 = V1(MCG). V1 not to exceed VR.

## TO2 Takeoff EPR

Based on engine bleed for packs on, engine anti-ice on or off and wing anti-ice off

AIRPORT OAT		AIRPORT PRESSURE ALTITUDE (FT)							
°F	°C	0	1000	2000	3000	4000	5000	6000	8000
131	55	1.24	1.23	1.23	1.22	1.22	1.21	1.21	1.20
122	50	1.26	1.26	1.26	1.26	1.25	1.25	1.24	1.23
113	45	1.28	1.28	1.28	1.28	1.28	1.28	1.28	1.27
104	40	1.30	1.30	1.31	1.31	1.31	1.31	1.31	1.30
95	35	1.31	1.32	1.33	1.33	1.33	1.33	1.33	1.33
86	30	1.33	1.34	1.34	1.35	1.35	1.36	1.35	1.35
77	25	1.33	1.34	1.36	1.37	1.37	1.38	1.38	1.37
68	20	1.33	1.34	1.36	1.37	1.38	1.40	1.40	1.40
59	15	1.33	1.34	1.36	1.37	1.38	1.40	1.40	1.42
50 & BELOW	10 & BELOW	1.33	1.34	1.36	1.37	1.38	1.40	1.40	1.42

## EPR Adjustments for Engine Bleeds

BLEED CONFIGURATION	AIRPORT PRESSURE ALTITUDE (FT)							
	0	1000	2000	3000	4000	5000	6000	8000
PACKS OFF	0.01	0.01	0.01	0.01	0.01	0.01	0.01	0.01
WING ANTI-ICE ON	-0.02	-0.02	-0.02	-0.02	-0.02	-0.02	-0.02	-0.02

757 Flight Crew Operations Manual

**Max Climb EPR**

**Based on engine bleed for packs on and anti-ice off**

TAT (°C)	PRESSURE ALTITUDE (1000 FT)/SPEED (KIAS OR MACH)								
	0	5	10	15	20	25	30	35	40
	250	250	250	290	290	290	290	.78	.78
60	1.15	1.14	1.12	1.08	1.05	1.02	0.99	0.98	0.97
50	1.18	1.17	1.16	1.11	1.09	1.06	1.04	1.03	1.02
40	1.22	1.21	1.19	1.15	1.13	1.11	1.09	1.08	1.07
30	1.24	1.25	1.23	1.20	1.18	1.16	1.14	1.13	1.12
20	1.24	1.27	1.28	1.25	1.23	1.21	1.19	1.18	1.18
10	1.24	1.27	1.30	1.29	1.29	1.27	1.26	1.25	1.24
0	1.24	1.27	1.30	1.29	1.32	1.35	1.33	1.32	1.32
-10	1.24	1.27	1.30	1.29	1.32	1.35	1.39	1.41	1.41
-20	1.24	1.27	1.30	1.29	1.32	1.35	1.39	1.48	1.50

**EPR Adjustments for Engine Bleeds**

BLEED CONFIGURATION	PRESSURE ALTITUDE (1000 FT)								
	0	5	10	15	20	25	30	35	40
PACKS OFF	0.01	0.01	0.01	0.01	0.02	0.02	0.03	0.04	0.04
ENGINE ANTI-ICE ON	0.00	0.00	-0.03	-0.03	-0.03	-0.04	-0.04	-0.05	-0.07
ENGINE & WING ANTI-ICE ON	-0.02	-0.02	-0.06	-0.06	-0.06	-0.07	-0.08	-0.10	-0.13

**Go-around EPR**

**Based on engine bleed for packs on and anti-ice off**

REPORTED OAT		TAT (°C)	AIRPORT PRESSURE ALTITUDE (FT)							
°F	°C		0	1000	2000	3000	4000	5000	6000	8000
131	55	58	1.27	1.27	1.27	1.27	1.27	1.27	1.27	1.27
122	50	53	1.30	1.30	1.30	1.30	1.30	1.29	1.29	1.29
113	45	48	1.33	1.33	1.33	1.33	1.33	1.33	1.33	1.33
104	40	43	1.35	1.36	1.36	1.36	1.36	1.36	1.36	1.36
95	35	38	1.37	1.38	1.39	1.39	1.40	1.40	1.40	1.40
86	30	33	1.40	1.41	1.41	1.42	1.43	1.43	1.43	1.43
77	25	28	1.40	1.42	1.43	1.45	1.46	1.46	1.46	1.46
68	20	23	1.40	1.42	1.43	1.45	1.47	1.49	1.50	1.49
59	15	18	1.40	1.42	1.43	1.45	1.47	1.49	1.51	1.52
50 & BELOW	10 & BELOW	13 & BELOW	1.40	1.42	1.43	1.45	1.47	1.49	1.51	1.53

**EPR Adjustments for Engine Bleeds**

BLEED CONFIGURATION	AIRPORT PRESSURE ALTITUDE (FT)							
	0	1000	2000	3000	4000	5000	6000	8000
PACKS OFF	0.01	0.01	0.01	0.01	0.01	0.01	0.01	0.01
WING ANTI-ICE ON	-0.02	-0.02	-0.02	-0.02	-0.02	-0.02	-0.02	-0.02

757 Flight Crew Operations Manual

**Flight With Unreliable Airspeed / Turbulent Air Penetration**  
Altitude and/or vertical speed indications may also be unreliable.

**Climb (290/.78)**

**Flaps Up, Set Max Climb Thrust**

PRESSURE ALTITUDE (FT)		WEIGHT (1000 LB)			
		140	180	220	260
40000	<b>PITCH ATT</b>	<b>4.5</b>	<b>4.0</b>		
	V/S (FT/MIN)	1600	700		
30000	<b>PITCH ATT</b>	<b>4.0</b>	<b>4.0</b>	<b>3.5</b>	<b>4.0</b>
	V/S (FT/MIN)	2200	1600	1100	700
20000	<b>PITCH ATT</b>	<b>6.5</b>	<b>6.0</b>	<b>5.5</b>	<b>5.5</b>
	V/S (FT/MIN)	3500	2600	1900	1400
10000	<b>PITCH ATT</b>	<b>9.5</b>	<b>8.0</b>	<b>7.5</b>	<b>7.0</b>
	V/S (FT/MIN)	4600	3500	2700	2100
SEA LEVEL	<b>PITCH ATT</b>	<b>12.5</b>	<b>10.5</b>	<b>9.5</b>	<b>8.5</b>
	V/S (FT/MIN)	5600	4200	3300	2600

**Cruise (.78/290)**

**Flaps Up, EPR for Level Flight**

PRESSURE ALTITUDE (FT)		WEIGHT (1000 LB)			
		140	180	220	260
40000	<b>PITCH ATT</b>	<b>2.5</b>	<b>3.0</b>		
	EPR	1.14	1.26		
	(Alt Mode %N1)	(77.1)	(81.3)		
35000	<b>PITCH ATT</b>	<b>1.5</b>	<b>2.5</b>	<b>3.0</b>	<b>3.5</b>
	EPR	1.08	1.13	1.23	1.38
	(Alt Mode %N1)	(74.6)	(77.1)	(80.4)	(85.7)
30000	<b>PITCH ATT</b>	<b>1.0</b>	<b>2.0</b>	<b>2.5</b>	<b>3.0</b>
	EPR	1.03	1.07	1.11	1.18
	(Alt Mode %N1)	(73.8)	(75.4)	(77.5)	(80.2)
25000	<b>PITCH ATT</b>	<b>1.5</b>	<b>2.0</b>	<b>2.5</b>	<b>3.5</b>
	EPR	0.99	1.02	1.05	1.10
	(Alt Mode %N1)	(70.3)	(71.9)	(73.8)	(76.3)
20000	<b>PITCH ATT</b>	<b>1.5</b>	<b>2.0</b>	<b>2.5</b>	<b>3.5</b>
	EPR	0.98	1.00	1.02	1.05
	(Alt Mode %N1)	(67.2)	(68.5)	(70.5)	(72.8)
15000	<b>PITCH ATT</b>	<b>1.5</b>	<b>2.0</b>	<b>3.0</b>	<b>3.5</b>
	EPR	0.97	0.98	1.00	1.03
	(Alt Mode %N1)	(64.0)	(65.3)	(67.2)	(69.5)

**Flight With Unreliable Airspeed / Turbulent Air Penetration**  
 Altitude and/or vertical speed indications may also be unreliable.

**Descent (.78/290)**

**Flaps Up, Set Idle Thrust**

PRESSURE ALTITUDE (FT)		WEIGHT (1000 LB)			
		140	180	220	260
40000	<b>PITCH ATT</b>	<b>-0.5</b>	<b>0.5</b>		
	V/S (FT/MIN)	-2300	-2300		
30000	<b>PITCH ATT</b>	<b>-2.0</b>	<b>-1.0</b>	<b>0.0</b>	<b>0.5</b>
	V/S (FT/MIN)	-2700	-2300	-2100	-2000
20000	<b>PITCH ATT</b>	<b>-2.0</b>	<b>-1.0</b>	<b>0.0</b>	<b>1.0</b>
	V/S (FT/MIN)	-2500	-2100	-1900	-1800
10000	<b>PITCH ATT</b>	<b>-2.5</b>	<b>-1.5</b>	<b>-0.5</b>	<b>0.5</b>
	V/S (FT/MIN)	-2400	-2000	-1800	-1700
SEA LEVEL	<b>PITCH ATT</b>	<b>-3.0</b>	<b>-1.5</b>	<b>-0.5</b>	<b>0.5</b>
	V/S (FT/MIN)	-2200	-1800	-1600	-1500

**Holding**

**Flaps Up, EPR for Level Flight**

PRESSURE ALTITUDE (FT)		WEIGHT (1000 LB)			
		140	180	220	260
10000	<b>PITCH ATT</b>	<b>5.5</b>	<b>5.5</b>	<b>6.0</b>	<b>6.0</b>
	EPR	1.01	1.02	1.03	1.04
	(Alt Mode %N1)	(50.9)	(56.4)	(61.0)	(64.9)
	KIAS	188	205	222	242
5000	<b>PITCH ATT</b>	<b>5.5</b>	<b>6.0</b>	<b>6.0</b>	<b>6.0</b>
	EPR	1.01	1.01	1.02	1.03
	(Alt Mode %N1)	(47.6)	(52.9)	(57.5)	(61.4)
	KIAS	188	205	222	241

**Terminal Area (5000 FT)**

**EPR for Level Flight**

FLAP POSITION (VREF + INCREMENT)		WEIGHT (1000 LB)			
		140	180	220	260
FLAPS 1 (GEAR UP) (VREF30 + 60)	<b>PITCH ATT</b>	<b>6.5</b>	<b>7.0</b>	<b>7.5</b>	<b>8.0</b>
	EPR	1.02	1.04	1.05	1.07
	KIAS	169	185	201	216
	(Alt Mode %N1)	(47.2)	(52.8)	(58.1)	(63.2)
FLAPS 5 (GEAR UP) (VREF30 + 40)	<b>PITCH ATT</b>	<b>7.0</b>	<b>7.0</b>	<b>7.5</b>	<b>7.5</b>
	EPR	1.04	1.05	1.07	1.09
	KIAS	149	165	181	196
	(Alt Mode %N1)	(47.2)	(53.6)	(59.6)	(64.1)
FLAPS 15 (GEAR UP) (VREF30 + 20)	<b>PITCH ATT</b>	<b>8.0</b>	<b>8.0</b>	<b>8.0</b>	<b>8.0</b>
	EPR	1.05	1.07	1.10	1.12
	KIAS	128	145	161	176
	(Alt Mode %N1)	(48.9)	(56.1)	(62.0)	(66.2)
FLAPS 20 (GEAR UP) (VREF30 + 20)	<b>PITCH ATT</b>	<b>5.0</b>	<b>5.0</b>	<b>5.0</b>	<b>5.0</b>
	EPR	1.06	1.08	1.12	1.14
	KIAS	128	145	161	176
	(Alt Mode %N1)	(50.5)	(58.0)	(63.5)	(67.9)

757 Flight Crew Operations Manual

**Flight With Unreliable Airspeed / Turbulent Air Penetration**  
**Altitude and/or vertical speed indications may also be unreliable.**  
**Final Approach (1500 FT)**  
**Gear Down, EPR for 3° Glideslope**

FLAP POSITION (VREF + INCREMENT)		WEIGHT (1000 LB)			
		140	180	220	260
FLAPS 25 (VREF25 + 10)	<b>PITCH ATT</b>	<b>2.5</b>	<b>2.5</b>	<b>2.5</b>	<b>2.5</b>
	EPR	1.03	1.04	1.06	1.07
	KIAS	121	137	152	167
	(Alt Mode %N1)	(42.0)	(47.6)	(52.7)	(57.6)
FLAPS 30 (VREF30 + 10)	<b>PITCH ATT</b>	<b>1.0</b>	<b>1.0</b>	<b>0.5</b>	<b>0.5</b>
	EPR	1.04	1.06	1.08	1.11
	KIAS	118	135	151	165
	(Alt Mode %N1)	(45.4)	(52.0)	(58.2)	(63.1)



**Performance Inflight**  
**All Engine**

**Chapter PI**  
**Section 21**

**Long Range Cruise Maximum Operating Altitude**  
**ISA + 10°C and Below**

WEIGHT (1000 LB)	OPTIMUM ALT (FT)	TAT (°C)	MARGIN TO INITIAL BUFFET 'G' (BANK ANGLE)				
			1.20 (33°)	1.25 (36°)	1.30 (39°)	1.40 (44°)	1.50 (48°)
260	31100	-6	34700*	34700*	34700	33100	31600
250	31900	-8	35800*	35800*	35500	33900	32500
240	32800	-10	36700*	36700*	36300	34800	33300
230	33700	-12	37500*	37500*	37200	35700	34200
220	34700	-14	38400*	38400*	38100	36600	35200
210	35600	-17	39300*	39300*	39100	37600	36100
200	36600	-18	40200*	40200*	40100	38600	37200
190	37700	-18	41200*	41200*	41200	39700	38200
180	38800	-18	42000	42000	42000	40800	39400
170	40000	-18	42000	42000	42000	42000	40500
160	41300	-18	42000	42000	42000	42000	41800
150	42000	-18	42000	42000	42000	42000	42000
140	42000	-18	42000	42000	42000	42000	42000

**ISA + 15°C**

WEIGHT (1000 LB)	OPTIMUM ALT (FT)	TAT (°C)	MARGIN TO INITIAL BUFFET 'G' (BANK ANGLE)				
			1.20 (33°)	1.25 (36°)	1.30 (39°)	1.40 (44°)	1.50 (48°)
260	31100	-1	33100*	33100*	33100*	33100	31600
250	31900	-3	34400*	34400*	34400*	33900	32500
240	32800	-5	35700*	35700*	35700*	34800	33300
230	33700	-7	36700*	36700*	36700*	35700	34200
220	34700	-9	37500*	37500*	37500*	36600	35200
210	35600	-11	38400*	38400*	38400*	37600	36100
200	36600	-12	39300*	39300*	39300*	38600	37200
190	37700	-12	40300*	40300*	40300*	39700	38200
180	38800	-12	41300*	41300*	41300*	40800	39400
170	40000	-12	42000	42000	42000	42000	40500
160	41300	-12	42000	42000	42000	42000	41800
150	42000	-12	42000	42000	42000	42000	42000
140	42000	-12	42000	42000	42000	42000	42000

**ISA + 20°C**

WEIGHT (1000 LB)	OPTIMUM ALT (FT)	TAT (°C)	MARGIN TO INITIAL BUFFET 'G' (BANK ANGLE)				
			1.20 (33°)	1.25 (36°)	1.30 (39°)	1.40 (44°)	1.50 (48°)
260	31100	5	30600*	30600*	30600*	30600*	30600*
250	31900	3	32100*	32100*	32100*	32100*	32100*
240	32800	1	33700*	33700*	33700*	33700*	33300
230	33700	-1	35200*	35200*	35200*	35200*	34200
220	34700	-3	36400*	36400*	36400*	36400*	35200
210	35600	-5	37300*	37300*	37300*	37300*	36100
200	36600	-6	38200*	38200*	38200*	38200*	37200
190	37700	-6	39200*	39200*	39200*	39200*	38200
180	38800	-6	40200*	40200*	40200*	40200*	39400
170	40000	-6	41200*	41200*	41200*	41200*	40500
160	41300	-6	42000	42000	42000	42000	41800
150	42000	-6	42000	42000	42000	42000	42000
140	42000	-6	42000	42000	42000	42000	42000

\*Denotes altitude thrust limited in level flight, 100 fpm residual rate of climb.

757 Flight Crew Operations Manual

**Long Range Cruise Control**

WEIGHT (1000 LB)		PRESSURE ALTITUDE (1000 FT)										
		21	23	25	27	29	31	33	35	37	39	41
260	EPR	1.05	1.07	1.09	1.12	1.16	1.21	1.29				
	MACH	.718	.743	.770	.789	.796	.798	.796				
	KIAS	326	325	324	319	309	297	283				
	FF/ENG	4786	4776	4781	4730	4654	4580	4551				
240	EPR	1.03	1.05	1.08	1.10	1.13	1.17	1.23	1.30			
	MACH	.700	.719	.745	.773	.790	.796	.798	.795			
	KIAS	317	314	313	312	306	296	284	270			
	FF/ENG	4065	4415	4403	4410	4351	4280	4213	4196			
220	EPR	1.03	1.04	1.06	1.08	1.11	1.14	1.18	1.24	1.32		
	MACH	.668	.699	.719	.745	.773	.790	.797	.798	.794		
	KIAS	302	304	301	300	299	293	283	271	258		
	FF/ENG	4068	4092	4044	4032	4038	3978	3916	3850	3877		
200	EPR	1.02	1.03	1.04	1.06	1.08	1.11	1.14	1.18	1.24	1.32	
	MACH	.640	.664	.696	.717	.743	.772	.790	.797	.798	.794	
	KIAS	289	288	291	288	287	286	281	271	259	246	
	FF/ENG	3710	3697	3716	3676	3662	3665	3617	3556	3525	3575	
180	EPR	1.01	1.02	1.03	1.04	1.06	1.08	1.11	1.14	1.18	1.24	1.32
	MACH	.619	.635	.659	.690	.713	.739	.768	.789	.796	.798	.795
	KIAS	279	275	274	276	274	273	272	268	258	247	235
	FF/ENG	3404	3346	3324	3376	3345	3291	3298	3262	3230	3223	3263
160	EPR	1.00	1.01	1.02	1.03	1.04	1.06	1.08	1.11	1.14	1.18	1.24
	MACH	.600	.614	.629	.650	.680	.707	.731	.761	.787	.795	.798
	KIAS	270	265	261	259	260	260	258	257	255	246	236
	FF/ENG	3143	3082	3018	2986	2994	2952	2936	2941	2949	2937	2928
140	EPR	.99	1.00	1.01	1.02	1.03	1.04	1.05	1.07	1.10	1.13	1.17
	MACH	.573	.592	.606	.621	.638	.664	.698	.720	.749	.778	.792
	KIAS	257	255	251	247	243	243	245	242	241	240	234
	FF/ENG	2831	2790	2725	2668	2620	2582	2603	2580	2636	2682	2682
120	EPR	.99	.99	1.00	1.00	1.01	1.02	1.04	1.05	1.07	1.09	1.12
	MACH	.537	.557	.577	.595	.610	.625	.646	.676	.706	.731	.762
	KIAS	241	240	239	236	232	228	226	226	226	224	224
	FF/ENG	2486	2456	2422	2381	2326	2272	2242	2250	2278	2559	2611

Shaded area approximates optimum altitude.

**Long Range Cruise Enroute Fuel and Time - Low Altitudes**  
**Ground to Air Miles Conversion**

AIR DISTANCE (NM)					GROUND DISTANCE (NM)	AIR DISTANCE (NM)				
HEADWIND COMPONENT (KTS)						TAILWIND COMPONENT (KTS)				
100	80	60	40	20		20	40	60	80	100
282	261	242	226	213	200	191	182	174	167	160
563	521	484	452	425	400	382	365	349	335	322
844	782	726	679	637	600	573	548	525	503	484
1127	1044	970	906	850	800	764	731	700	672	646
1412	1307	1213	1133	1063	1000	955	914	875	840	808
1697	1570	1457	1361	1276	1200	1146	1096	1050	1008	970
1984	1835	1701	1588	1489	1400	1337	1278	1225	1176	1131
2273	2101	1948	1817	1703	1600	1528	1461	1400	1343	1292
2563	2367	2193	2045	1916	1800	1719	1643	1574	1511	1453

**Reference Fuel And Time Required at Check Point**

AIR DIST (NM)	PRESSURE ALTITUDE (1000 FT)									
	10		14		18		22		28	
	FUEL (1000 LB)	TIME (HR:MIN)	FUEL (1000 LB)	TIME (HR:MIN)	FUEL (1000 LB)	TIME (HR:MIN)	FUEL (1000 LB)	TIME (HR:MIN)	FUEL (1000 LB)	TIME (HR:MIN)
200	4.4	0:39	3.8	0:38	3.4	0:38	3.0	0:37	2.5	0:35
400	9.0	1:14	8.1	1:11	7.3	1:09	6.7	1:07	5.9	1:03
600	13.6	1:49	12.4	1:44	11.2	1:41	10.3	1:38	9.2	1:31
800	18.1	2:24	16.6	2:18	15.1	2:13	14.0	2:09	12.5	2:00
1000	22.6	3:00	20.7	2:51	19.0	2:45	17.6	2:40	15.7	2:28
1200	27.0	3:36	24.8	3:25	22.8	3:18	21.1	3:12	19.0	2:56
1400	31.4	4:12	28.9	3:59	26.5	3:50	24.6	3:43	22.2	3:25
1600	35.8	4:49	33.0	4:34	30.2	4:23	28.1	4:15	25.4	3:54
1800	40.1	5:26	37.0	5:09	33.9	4:56	31.6	4:47	28.6	4:23

**Fuel Required Adjustment (1000 LB)**

REFERENCE FUEL REQUIRED (1000 LB)	WEIGHT AT CHECK POINT (1000 LB)					
	160	180	200	220	240	260
10	-0.8	-0.4	0.0	0.5	1.0	1.5
20	-1.7	-0.8	0.0	1.0	2.1	3.2
30	-2.5	-1.3	0.0	1.4	3.1	4.7
40	-3.3	-1.7	0.0	1.8	4.0	6.2
50	-4.0	-2.1	0.0	2.1	4.8	7.6

**Long Range Cruise Enroute Fuel and Time - High Altitudes  
Ground to Air Miles Conversion**

AIR DISTANCE (NM)					GROUND DISTANCE (NM)	AIR DISTANCE (NM)					
HEADWIND COMPONENT (KTS)						TAILWIND COMPONENT (KTS)	20	40	60	80	100
100	80	60	40	20							
658	619	584	553	525	500	479	458	440	423	407	
1309	1234	1166	1105	1050	1000	957	918	881	848	817	
1964	1851	1749	1657	1575	1500	1437	1378	1323	1273	1228	
2621	2470	2332	2210	2100	2000	1916	1838	1766	1699	1638	
3282	3092	2918	2765	2627	2500	2395	2297	2207	2124	2048	
3949	3717	3507	3320	3153	3000	2874	2756	2648	2548	2457	
4621	4347	4098	3878	3681	3500	3353	3216	3089	2972	2866	
5298	4980	4691	4437	4209	4000	3831	3674	3529	3396	3274	

**Reference Fuel And Time Required at Check Point**

AIR DIST (NM)	PRESSURE ALTITUDE (1000 FT)									
	29		31		33		35		37	
	FUEL (1000 LB)	TIME (HR:MIN)	FUEL (1000 LB)	TIME (HR:MIN)	FUEL (1000 LB)	TIME (HR:MIN)	FUEL (1000 LB)	TIME (HR:MIN)	FUEL (1000 LB)	TIME (HR:MIN)
500	7.4	1:16	7.1	1:15	6.9	1:14	6.7	1:14	6.6	1:14
1000	15.5	2:26	15.0	2:22	14.5	2:20	14.2	2:19	14.0	2:20
1500	23.5	3:37	22.6	3:31	22.0	3:26	21.4	3:25	21.2	3:25
2000	31.2	4:49	30.1	4:41	29.3	4:34	28.5	4:31	28.2	4:31
2500	38.8	6:02	37.4	5:53	36.4	5:43	35.4	5:38	35.0	5:37
3000	46.3	7:17	44.5	7:05	43.3	6:54	42.2	6:46	41.6	6:43
3500	53.5	8:34	51.5	8:18	50.1	8:05	48.8	7:55	48.0	7:50
4000	60.5	9:53	58.3	9:33	56.7	9:18	55.3	9:06	54.4	8:58

**Fuel Required Adjustment (1000 LB)**

REFERENCE FUEL REQUIRED (1000 LB)	WEIGHT AT CHECK POINT (1000 LB)					
	160	180	200	220	240	260
10	-0.8	-0.4	0.0	0.8	2.1	4.1
20	-2.1	-1.0	0.0	1.7	4.0	7.5
30	-3.3	-1.5	0.0	2.5	5.7	10.4
40	-4.4	-2.1	0.0	3.2	7.2	12.8
50	-5.3	-2.7	0.0	3.8	8.5	14.8
60	-6.1	-3.3	0.0	4.4	9.7	16.3
70	-6.9	-3.9	0.0	4.9	10.6	17.4

**Long Range Cruise Wind-Altitude Trade**

PRESSURE ALTITUDE (1000 FT)	CRUISE WEIGHT (1000 LB)											
	250	240	230	220	210	200	190	180	170	160	150	140
41							18	7	1	0	2	8
39					19	8	2	0	1	4	11	19
37			18	8	3	0	0	3	8	15	23	32
35	14	7	2	0	0	2	6	12	19	27	36	46
33	1	0	0	2	6	11	17	24	32	40	50	60
31	0	2	6	11	16	22	29	37	45	54	64	75
29	6	11	16	22	28	35	42	50	59	68	78	88
27	17	22	28	34	40	48	55	64	73	82	91	102
25	28	34	40	46	53	61	69	77	86	95	104	

The above wind factor table is for calculation of wind required to maintain present range capability at new pressure altitude, i.e., break-even wind.

Method:

1. Read wind factors for present and new altitudes from table.
2. Determine difference (new altitude wind factor minus present altitude wind factor); This difference may be negative or positive.
3. Break-even wind at new altitude is present altitude wind plus difference from step 2.

**Descent at .78/290/250**

PRESSURE ALT (1000 FT)	15	17	19	21	23	25	27	29	31	33	35	37	39	41
DISTANCE (NM)	51	57	64	70	77	83	90	97	104	109	114	120	126	133
TIME (MINUTES)	14	15	16	16	17	18	19	20	21	21	22	23	24	25

**Holding  
 Flaps Up**

WEIGHT (1000 LB)		PRESSURE ALTITUDE (FT)									
		1500	5000	10000	15000	20000	25000	30000	35000	40000	
260	EPR	1.03	1.03	1.05	1.07	1.11	1.16	1.25			
	KIAS	241	241	242	243	245	247	250			
	FF/ENG	4580	4490	4350	4290	4260	4310	4430			
240	EPR	1.02	1.03	1.04	1.06	1.09	1.14	1.21	1.32		
	KIAS	231	232	233	234	235	237	239	246		
	FF/ENG	4270	4170	4020	3960	3930	3950	4020	4180		
220	EPR	1.02	1.03	1.04	1.05	1.08	1.12	1.18	1.29		
	KIAS	221	222	223	224	225	226	228	231		
	FF/ENG	3960	3860	3700	3620	3600	3600	3680	3760		
200	EPR	1.02	1.02	1.03	1.04	1.07	1.10	1.16	1.24	1.37	
	KIAS	213	213	213	213	214	215	217	220	234	
	FF/ENG	3650	3560	3390	3320	3300	3290	3310	3360	3730	
180	EPR	1.01	1.02	1.02	1.04	1.05	1.08	1.13	1.20	1.31	
	KIAS	205	205	205	205	205	205	205	207	211	
	FF/ENG	3350	3290	3120	3010	2970	2960	2960	2970	3190	
160	EPR	1.01	1.01	1.02	1.03	1.04	1.06	1.10	1.16	1.26	
	KIAS	197	197	197	197	197	197	197	197	197	
	FF/ENG	3070	2990	2830	2710	2650	2640	2620	2640	2800	
140	EPR	1.01	1.01	1.01	1.02	1.03	1.04	1.07	1.12	1.19	
	KIAS	188	188	188	188	188	188	188	188	188	
	FF/ENG	2770	2690	2540	2420	2350	2320	2300	2300	2410	

**This table includes 5% additional fuel for holding in a racetrack pattern.**

Intentionally  
Blank

**Performance Inflight**  
**Advisory Information**

**Chapter PI**  
**Section 22**

**ADVISORY INFORMATION**

**Normal Configuration Landing Distance**

**Flaps 30**

**Dry Runway**

BRAKING CONFIGURATION	LANDING DISTANCE AND ADJUSTMENTS (FT)											
	REF DIST	WT ADJ	ALT ADJ	WIND ADJ PER 10 KTS		SLOPE ADJ PER 1%		TEMP ADJ PER 10°C		VREF ADJ	REVERSE THRUST ADJ	
	190000 LB LANDING WEIGHT	PER 10000 LB ABOVE/BELOW 190000 LB	PER 1000 FT STD/HIGH*	HEAD WIND	TAIL WIND	DOWN HILL	UP HILL	ABV ISA	BLW ISA	PER 10 KTS ABOVE VREF30	ONE REV	NO REV
MAX MANUAL	2700	+100/-90	60/70	-110	380	40	-30	50	-50	210	60	130
MAX AUTO	4050	+160/-160	90/120	-180	570	50	-50	90	-90	310	180	360
AUTOBRAKE 4	4380	+190/-180	110/140	-210	680	60	-60	110	-100	360	190	390
AUTOBRAKE 3	4950	+240/-240	140/180	-250	850	90	-90	140	-130	410	240	470
AUTOBRAKE 2	5300	+290/-280	170/220	-290	980	150	-150	160	-140	410	540	800
AUTOBRAKE 1	5540	+330/-290	190/270	-320	1110	190	-170	170	-150	410	960	1450

**Good Reported Braking Action**

MAX MANUAL	3520	+150/-130	90/120	-170	610	80	-70	80	-80	280	220	540
MAX AUTO	4210	+180/-170	100/140	-200	690	90	-80	100	-90	310	360	910
AUTOBRAKE 4	4430	+190/-190	110/140	-220	730	80	-70	110	-110	360	240	670
AUTOBRAKE 3	4950	+240/-240	140/180	-250	850	90	-90	140	-130	410	240	480

**Medium Reported Braking Action**

MAX MANUAL	4570	+220/-190	130/180	-260	970	180	-140	120	-110	340	590	1640
MAX AUTO	4820	+240/-220	140/190	-280	1000	190	-160	130	-110	340	740	2050
AUTOBRAKE 4	4850	+240/-220	140/190	-280	1000	180	-150	130	-110	360	720	2020
AUTOBRAKE 3	5190	+250/-250	150/190	-300	1060	160	-150	140	-130	410	460	1660

**Poor Reported Braking Action**

MAX MANUAL	5630	+290/-260	170/250	-370	1470	390	-260	150	-130	380	1200	3850
MAX AUTO	5630	+300/-280	180/250	-400	1480	390	-280	160	-130	370	1320	4200
AUTOBRAKE 4	5630	+300/-280	180/250	-400	1480	390	-280	160	-130	380	1320	4200
AUTOBRAKE 3	5740	+300/-280	170/250	-400	1490	370	-270	160	-140	410	1200	4080

Reference distance is for sea level, standard day, no wind or slope, VREF30 approach speed and 2 engine reverse thrust.

Max Manual braking data valid for auto speedbrakes. For manual speedbrakes, increase reference landing distance by 270 ft.

Autobrake data valid both for auto and manual speedbrakes.

Actual (unfactored) distances are shown.

Includes distance from 50 ft above threshold (1000 ft of air distance).

\*For landing distance at or below 8000 ft pressure altitude, apply the STD adjustment. For altitudes higher than 8000 ft, first apply the STD adjustment to derive a new reference landing distance for 8000 ft, then apply the HIGH adjustment to this new reference distance.

**ADVISORY INFORMATION**

**Normal Configuration Landing Distance**

**Flaps 25**

**Dry Runway**

BRAKING CONFIGURATION	LANDING DISTANCE AND ADJUSTMENTS (FT)											
	REF DIST	WT ADJ	ALT ADJ	WIND ADJ PER 10 KTS		SLOPE ADJ PER 1%		TEMP ADJ PER 10°C		VREF ADJ	REVERSE THRUST ADJ	
	190000 LB LANDING WEIGHT	PER 10000 LB ABOVE/BELOW 190000 LB	PER 1000 FT STD/HIGH*	HEAD WIND	TAIL WIND	DOWN HILL	UP HILL	ABV ISA	BLW ISA	PER 10 KTS ABOVE VREF25	ONE REV	NO REV
MAX MANUAL	2730	+90/-90	60/80	-110	390	40	-30	60	-50	210	60	140
MAX AUTO	4170	+160/-160	100/130	-180	580	50	-50	100	-90	320	190	400
AUTOBRAKE 4	4520	+190/-190	110/150	-210	690	60	-60	120	-110	380	210	430
AUTOBRAKE 3	5120	+240/-240	140/190	-260	860	90	-100	150	-130	430	270	530
AUTOBRAKE 2	5480	+290/-290	180/240	-300	1000	160	-160	180	-150	430	610	900
AUTOBRAKE 1	5720	+330/-300	200/280	-330	1120	200	-180	190	-150	430	1070	1600

**Good Reported Braking Action**

MAX MANUAL	3580	+150/-130	90/120	-170	610	80	-70	80	-80	280	230	580
MAX AUTO	4320	+180/-170	100/140	-210	690	90	-80	100	-100	320	380	990
AUTOBRAKE 4	4570	+190/-190	110/150	-220	740	80	-80	120	-110	380	250	720
AUTOBRAKE 3	5120	+240/-240	140/190	-260	860	90	-100	150	-130	430	270	530

**Medium Reported Braking Action**

MAX MANUAL	4670	+220/-190	130/190	-260	980	180	-150	120	-110	350	640	1810
MAX AUTO	4950	+240/-220	140/200	-290	1010	190	-160	140	-120	350	810	2270
AUTOBRAKE 4	4990	+230/-220	140/200	-290	1010	180	-150	130	-120	380	770	2230
AUTOBRAKE 3	5360	+250/-250	150/200	-310	1080	170	-150	150	-140	430	500	1840

**Poor Reported Braking Action**

MAX MANUAL	5780	+290/-260	170/250	-370	1490	400	-270	160	-140	390	1300	4320
MAX AUTO	5780	+300/-280	180/260	-400	1490	400	-290	170	-140	390	1440	4730
AUTOBRAKE 4	5780	+300/-280	180/260	-400	1490	400	-290	170	-140	390	1430	4720
AUTOBRAKE 3	5920	+300/-280	180/250	-410	1510	380	-270	170	-140	430	1290	4590

Reference distance is for sea level, standard day, no wind or slope, VREF25 approach speed and 2 engine reverse thrust.

Max Manual braking data valid for auto speedbrakes. For manual speedbrakes, increase reference landing distance by 270 ft.

Autobrake data valid for both auto and manual speedbrakes.

Actual (unfactored) distances are shown.

Includes distance from 50 ft above threshold (1000 ft of air distance).

\*For landing distance at or below 8000 ft pressure altitude, apply the STD adjustment. For altitudes higher than 8000 ft, first apply the STD adjustment to derive a new reference landing distance for 8000 ft, then apply the HIGH adjustment to this new reference distance.



**ADVISORY INFORMATION**

**Non-Normal Configuration Landing Distance  
Dry Runway**

LANDING CONFIGURATION	VREF	LANDING DISTANCE AND ADJUSTMENTS (FT)							
		REFERENCE DISTANCE* FOR 190000 LB LANDING WEIGHT	WT ADJ PER 5000 LB ABOVE/BELOW 190000 LB	ALTITUDE ADJ PER 1000 FT STD/HIGH ***	WIND ADJ PER 10 KTS		SLOPE ADJ PER 1%		APPROACH SPEED
					HEAD WIND	TAIL WIND	DOWN HILL	UP HILL	PER 10 KTS ABOVE VREF
AIR-GROUND LOGIC IN AIR MODE	VREF30	3550	70/-60	85/120	-150	535	75	-65	400
ANTI-SKID SYSTEM INOP	VREF30	4070	85/-75	95/140	-195	730	90	-75	320
FLAPS UP	VREF30+50	3650	160/-60	100/160	-150	585	55	-50	285
HYDRAULIC SYSTEM CENTER INOP	VREF30	2740	55/-45	60/80	-110	400	40	-35	235
HYDRAULIC SYSTEM LEFT INOP	VREF30	3250	65/-55	70/100	-135	475	50	-45	310
HYDRAULIC SYSTEM LEFT INOP WITH LE SLAT OR TE FLAPS DISAGREE FOR FLAPS ≥ 20	VREF20	3520	65/-60	80/110	-140	490	55	-50	310
HYDRAULIC SYSTEM RIGHT INOP	VREF30	3300	70/-60	80/120	-145	515	75	-65	355
HYDRAULIC SYSTEMS CENTER AND LEFT INOP FLAPS 20	VREF30+20	3930	75/-65	95/130	-155	530	65	-60	360
HYDRAULIC SYSTEMS CENTER AND RIGHT INOP FLAPS 20	VREF30+20	4070	80/-75	110/155	-170	585	100	-85	425
HYDRAULIC SYSTEM** LEFT & RIGHT INOP FLAPS 20	VREF30+20	5590	105/-90	155/245	-240	815	220	-175	755

\* Reference distance assumes sea level, standard day with no wind or slope.

\*\* Reserve Brake System Only.

Assumes maximum manual braking and maximum reverse thrust when available on operating engine(s). Actual (unfactored) distances are shown.

Includes distance from 50 ft above threshold (1000 ft of air distance).

\*\*\* For landing distance at or below 8000 ft pressure altitude, apply the STD adjustment. For altitudes higher than 8000 ft, first apply the STD adjustment to derive a new reference landing distance for 8000 ft, then apply HIGH adjustment to this new reference distance.

**ADVISORY INFORMATION**

**Non-Normal Configuration Landing Distance  
Dry Runway**

LANDING CONFIGURATION	VREF	LANDING DISTANCE AND ADJUSTMENTS (FT)							
		REFERENCE DISTANCE* FOR 190000 LB LANDING WEIGHT	WT ADJ PER 5000 LB ABOVE/BELOW 190000 LB	ALTITUDE ADJ PER 1000 FT STD/HIGH ***	WIND ADJ PER 10 KTS		SLOPE ADJ PER 1%		APPROACH SPEED
					HEAD WIND	TAIL WIND	DOWN HILL	UP HILL	
LE SLAT ASYMMETRY FLAPS>20	VREF20	2870	65/-50	60/75	-115	395	35	-35	220
LE SLAT ASYMMETRY FLAPS = 20	VREF30+30	3330	95/-55	80/105	-125	430	45	-40	230
LE SLAT ASYMMETRY 5 ≤ FLAPS < 20	VREF30+40	3550	120/-60	85/130	-130	445	45	-45	235
LE SLAT DISAGREE	VREF20	2860	70/-45	65/80	-110	430	35	-35	220
ONE ENGINE INOP	VREF20	2920	75/-50	65/85	-115	450	40	-35	235
REVERSER UNLOCK FLAPS 20	VREF30+30	3360	105/-55	80/105	-135	505	50	-45	265
TRAILING EDGE FLAP ASYMMETRY FLAPS ≥ 20	VREF20	2860	70/-45	65/80	-110	430	35	-35	220
TRAILING EDGE ASYMMETRY 5<FLAPS<20	VREF30+30	3240	115/-50	75/100	-135	495	45	-40	245
TRAILING EDGE ASYMMETRY FLAPS ≤ 5	VREF30+40	3450	135/-55	80/125	-140	525	50	-45	255
TRAILING EDGE FLAP DISAGREE	VREF20	2860	70/-45	65/80	-110	430	35	-35	220

\* Reference distance assumes sea level, standard day with no wind or slope.

Assumes maximum manual braking and maximum reverse thrust when available on operating engine(s). Actual (unfactored) distances are shown.

Includes distance from 50 ft above threshold (1000 ft of air distance).

\*\*\* For landing distance at or below 8000 ft pressure altitude, apply the STD adjustment. For altitudes higher than 8000 ft, first apply the STD adjustment to derive a new reference landing distance for 8000 ft, then apply HIGH adjustment to this new reference distance.

**ADVISORY INFORMATION**

**Non-Normal Configuration Landing Distance  
Good Reported Braking Action**

LANDING CONFIGURATION	VREF	LANDING DISTANCE AND ADJUSTMENTS (FT)							
		REFERENCE DISTANCE* FOR 190000 LB LANDING WEIGHT	WT ADJ PER 5000 LB ABOVE/BELOW 190000 LB	ALTITUDE ADJ PER 1000 FT STD/HIGH ***	WIND ADJ PER 10 KTS		SLOPE ADJ PER 1%		APPROACH SPEED
					HEAD WIND	TAIL WIND	DOWN HILL	UP HILL	PER 10 KTS ABOVE VREF
AIR-GROUND LOGIC IN AIR MODE	VREF30	5180	110/-90	150/240	-270	965	255	-190	590
ANTI-SKID SYSTEM INOP	VREF30	4850	115/-100	130/185	-265	1035	170	-135	365
FLAPS UP	VREF30+50	4870	100/-90	140/190	-200	720	100	-90	285
HYDRAULIC SYSTEM CENTER INOP	VREF30	3540	80/-70	90/125	-170	630	85	-75	300
HYDRAULIC SYSTEM LEFT INOP	VREF30	4320	95/-85	115/170	-215	775	135	-110	415
HYDRAULIC SYSTEM LEFT INOP WITH LE SLAT OR TE FLAPS DISAGREE FOR FLAPS ≥ 20	VREF20	4750	95/-90	130/190	-225	810	145	-120	420
HYDRAULIC SYSTEM RIGHT INOP	VREF30	4210	100/-85	120/175	-210	770	150	-120	440
HYDRAULIC SYSTEMS CENTER AND LEFT INOP FLAPS 20	VREF30+20	5320	110/-100	150/225	-245	865	175	-140	480
HYDRAULIC SYSTEMS CENTER AND RIGHT INOP FLAPS 20	VREF30+20	5250	115/-105	155/240	-245	865	195	-160	520
HYDRAULIC SYSTEM** LEFT & RIGHT INOP FLAPS 20	VREF30+20	7440	140/-115	235/385	-350	1210	495	-355	980

\* Reference distance assumes sea level, standard day with no wind or slope.

\*\* Reserve Brake System only.

Assumes maximum manual braking and maximum reverse thrust when available on operating engine(s). Actual (unfactored) distances are shown.

Includes distance from 50 ft above threshold (1000 ft of air distance).

\*\*\* For landing distance at or below 8000 ft pressure altitude, apply the STD adjustment. For altitudes higher than 8000 ft, first apply the STD adjustment to derive a new reference landing distance for 8000 ft, then apply HIGH adjustment to this new reference distance.

**ADVISORY INFORMATION**

**Non-Normal Configuration Landing Distance**

**Good Reported Braking Action**

LANDING CONFIGURATION	VREF	LANDING DISTANCE AND ADJUSTMENTS (FT)							
		REFERENCE DISTANCE* FOR 190000 LB LANDING WEIGHT	WT ADJ PER 5000 LB ABOVE/BELOW 190000 LB	ALTITUDE ADJ PER 1000 FT STD/HIGH ***	WIND ADJ PER 10 KTS		SLOPE ADJ PER 1%		APPROACH SPEED
					HEAD WIND	TAIL WIND	DOWN HILL	UP HILL	
LE SLAT ASYMMETRY FLAPS>20	VREF20	3750	80/-75	95/135	-175	625	85	-75	290
LE SLAT ASYMMETRY FLAPS = 20	VREF30+30	4360	90/-85	120/170	-190	670	95	-85	300
LE SLAT ASYMMETRY 5 ≤ FLAPS < 20	VREF30+40	4690	95/-90	130/185	-200	695	100	-90	305
LE SLAT DISAGREE	VREF20	3740	75/-70	95/135	-175	640	85	-75	280
ONE ENGINE INOP	VREF20	3970	85/-80	105/140	-190	685	110	-90	320
REVERSER UNLOCK FLAPS 20	VREF30+30	4580	95/-90	125/170	-205	740	125	-105	325
TRAILING EDGE FLAP ASYMMETRY FLAPS ≥ 20	VREF20	3740	75/-70	95/135	-175	640	85	-75	280
TRAILING EDGE ASYMMETRY 5<FLAPS<20	VREF30+30	4280	90/-80	115/165	-185	680	90	-80	280
TRAILING EDGE ASYMMETRY FLAPS ≤ 5	VREF30+40	4560	95/-85	125/180	-190	700	95	-85	280
TRAILING EDGE FLAP DISAGREE	VREF20	3740	75/-70	95/135	-175	640	85	-75	280

\* Reference distance assumes sea level, standard day with no wind or slope.

Assumes maximum manual braking and maximum reverse thrust when available on operating engine(s). Actual (unfactored) distances are shown.

Includes distance from 50 ft above threshold (1000 ft of air distance).

\*\*\* For landing distance at or below 8000 ft pressure altitude, apply the STD adjustment. For altitudes higher than 8000 ft, first apply the STD adjustment to derive a new reference landing distance for 8000 ft, then apply HIGH adjustment to this new reference distance.

**ADVISORY INFORMATION**

**Non-Normal Configuration Landing Distance  
Medium Reported Braking Action**

LANDING CONFIGURATION	VREF	LANDING DISTANCE AND ADJUSTMENTS (FT)							
		REFERENCE DISTANCE* FOR 190000 LB LANDING WEIGHT	WT ADJ PER 5000 LB ABOVE/BELOW 190000 LB	ALTITUDE ADJ PER 1000 FT STD/HIGH ***	WIND ADJ PER 10 KTS		SLOPE ADJ PER 1%		APPROACH SPEED
					HEAD WIND	TAIL WIND	DOWN HILL	UP HILL	PER 10 KTS ABOVE VREF
AIR-GROUND LOGIC IN AIR MODE	VREF30	8530	160/-105	315/640	-545	2090	1210	-650	830
ANTI-SKID SYSTEM INOP	VREF30	5860	150/-130	170/255	-375	1565	385	-255	410
FLAPS UP	VREF30+50	6390	150/-135	205/295	-300	1140	230	-185	360
HYDRAULIC SYSTEM CENTER INOP	VREF30	4550	115/-100	135/190	-255	1005	195	-150	360
HYDRAULIC SYSTEM LEFT INOP	VREF30	5930	140/-120	185/305	-350	1360	380	-265	515
HYDRAULIC SYSTEM LEFT INOP WITH LE SLAT OR TE FLAPS DISAGREE FOR FLAPS ≥ 20	VREF20	6610	145/-135	210/345	-375	1425	420	-290	540
HYDRAULIC SYSTEM RIGHT INOP	VREF30	5890	150/-125	195/325	-355	1365	415	-285	540
HYDRAULIC SYSTEMS CENTER AND LEFT INOP FLAPS 20	VREF30+20	7360	170/-150	245/395	-400	1500	475	-335	595
HYDRAULIC SYSTEMS CENTER AND RIGHT INOP FLAPS 20	VREF30+20	7400	180/-155	260/420	-405	1515	525	-365	635
HYDRAULIC SYSTEM** LEFT & RIGHT INOP FLAPS 20	VREF30+20	13060	210/-105	510/1075	-730	2640	2455	-1215	1420

\* Reference distance assumes sea level, standard day with no wind or slope.

\*\* Reserve Brake System Only.

Assumes maximum manual braking and maximum reverse thrust when available on operating engine(s). Actual (unfactored) distances are shown.

Includes distance from 50 ft above threshold (1000 ft of air distance).

\*\*\* For landing distance at or below 8000 ft pressure altitude, apply the STD adjustment. For altitudes higher than 8000 ft, first apply the STD adjustment to derive a new reference landing distance for 8000 ft, then apply HIGH adjustment to this new reference distance.

**ADVISORY INFORMATION**

**Non-Normal Configuration Landing Distance  
Medium Reported Braking Action**

LANDING CONFIGURATION	VREF	LANDING DISTANCE AND ADJUSTMENTS (FT)							
		REFERENCE DISTANCE* FOR 190000 LB LANDING WEIGHT	WT ADJ PER 5000 LB ABOVE/BELOW 190000 LB	ALTITUDE ADJ PER 1000 FT STD/HIGH ***	WIND ADJ PER 10 KTS		SLOPE ADJ PER 1%		APPROACH SPEED
					HEAD WIND	TAIL WIND	DOWN HILL	UP HILL	
LE SLAT ASYMMETRY FLAPS>20	VREF20	4880	115/-105	140/210	-265	990	185	-150	360
LE SLAT ASYMMETRY FLAPS = 20	VREF30+30	5640	135/-120	170/245	-285	1050	205	-170	360
LE SLAT ASYMMETRY 5 ≤ FLAPS < 20	VREF30+40	6100	145/-130	195/280	-295	1085	215	-180	370
LE SLAT DISAGREE	VREF20	4870	115/-105	140/210	-265	1025	195	-150	350
ONE ENGINE INOP	VREF20	5480	130/-120	160/230	-305	1155	285	-210	420
REVERSER UNLOCK FLAPS 20	VREF30+30	6280	150/-135	190/270	-325	1220	310	-235	415
TRAILING EDGE FLAP ASYMMETRY FLAPS ≥ 20	VREF20	4870	115/-105	140/210	-265	1025	195	-150	350
TRAILING EDGE ASYMMETRY 5<FLAPS<20	VREF30+30	5600	135/-120	175/250	-280	1080	210	-165	350
TRAILING EDGE ASYMMETRY FLAPS ≤ 5	VREF30+40	5950	140/-125	185/270	-290	1105	220	-170	350
TRAILING EDGE FLAP DISAGREE	VREF20	4870	115/-105	140/210	-265	1025	195	-150	350

\* Reference distance assumes sea level, standard day with no wind or slope.

Assumes maximum manual braking and maximum reverse thrust when available on operating engine(s). Actual (unfactored) distances are shown.

Includes distance from 50 ft above threshold (1000 ft of air distance).

\*\*\* For landing distance at or below 8000 ft pressure altitude, apply the STD adjustment. For altitudes higher than 8000 ft, first apply the STD adjustment to derive a new reference landing distance for 8000 ft, then apply HIGH adjustment to this new reference distance.

**ADVISORY INFORMATION**

**Non-Normal Configuration Landing Distance  
Poor Reported Braking Action**

LANDING CONFIGURATION	VREF	LANDING DISTANCE AND ADJUSTMENTS (FT)							
		REFERENCE DISTANCE* FOR 190000 LB LANDING WEIGHT	WT ADJ PER 5000 LB ABOVE/BELOW 190000 LB	ALTITUDE ADJ PER 1000 FT STD/HIGH ***	WIND ADJ PER 10 KTS		SLOPE ADJ PER 1%		APPROACH SPEED
					HEAD WIND	TAIL WIND	DOWN HILL	UP HILL	PER 10 KTS ABOVE VREF
AIR-GROUND LOGIC IN AIR MODE	VREF30	> 15000	-	-	-	-	-	-	-
ANTI-SKID SYSTEM INOP	VREF30	7460	205/-175	235/335	-600	2865	2340	-565	445
FLAPS UP	VREF30+50	7880	200/-180	275/400	-425	1720	515	-325	415
HYDRAULIC SYSTEM CENTER INOP	VREF30	5590	155/-130	175/265	-370	1545	445	-270	400
HYDRAULIC SYSTEM LEFT INOP	VREF30	8060	190/-150	300/555	-590	2555	1645	-615	590
HYDRAULIC SYSTEM LEFT INOP WITH LE SLAT OR TE FLAPS DISAGREE FOR FLAPS ≥ 20	VREF20	9050	205/-175	340/630	-630	2670	1790	-680	635
HYDRAULIC SYSTEM RIGHT INOP	VREF30	8090	200/-155	315/585	-600	2580	1740	-650	610
HYDRAULIC SYSTEMS CENTER AND LEFT INOP FLAPS 20	VREF30+20	9960	235/-190	380/705	-665	2775	1930	-745	675
HYDRAULIC SYSTEMS CENTER AND RIGHT INOP FLAPS 20	VREF30+20	10100	250/-200	405/750	-675	2805	2055	-800	715
HYDRAULIC SYSTEM** LEFT & RIGHT INOP FLAPS 20	VREF30+20	> 15000	-	-	-	-	-	-	-

\* Reference distance assumes sea level, standard day with no wind or slope.

\*\* Reserve Brake System only.

Assumes maximum manual braking and maximum reverse thrust when available on operating engine(s). Actual (unfactored) distances are shown.

Includes distance from 50 ft above threshold (1000 ft of air distance).

\*\*\* For landing distance at or below 8000 ft pressure altitude, apply the STD adjustment. For altitudes higher than 8000 ft, first apply the STD adjustment to derive a new reference landing distance for 8000 ft, then apply HIGH adjustment to this new reference distance.

**ADVISORY INFORMATION**

**Non-Normal Configuration Landing Distance  
Poor Reported Braking Action**

LANDING CONFIGURATION	VREF	LANDING DISTANCE AND ADJUSTMENTS (FT)							
		REFERENCE DISTANCE* FOR 190000 LB LANDING WEIGHT	WT ADJ PER 5000 LB ABOVE/BELOW 190000 LB	ALTITUDE ADJ PER 1000 FT STD/HIGH ***	WIND ADJ PER 10 KTS		SLOPE ADJ PER 1%		APPROACH SPEED
					HEAD WIND	TAIL WIND	DOWN HILL	UP HILL	
LE SLAT ASYMMETRY FLAPS>20	VREF20	6020	155/-140	190/285	-380	1510	410	-275	405
LE SLAT ASYMMETRY FLAPS = 20	VREF30+30	6890	180/-160	225/340	-405	1580	435	-300	400
LE SLAT ASYMMETRY 5 ≤ FLAPS < 20	VREF30+40	7490	195/-175	255/370	-420	1625	455	-315	425
LE SLAT DISAGREE	VREF20	6020	155/-140	190/285	-380	1580	455	-280	395
ONE ENGINE INOP	VREF20	7170	190/-175	230/335	-460	1845	720	-420	500
REVERSER UNLOCK FLAPS 20	VREF30+30	8120	210/-190	270/380	-485	1925	760	-450	485
TRAILING EDGE FLAP ASYMMETRY FLAPS ≥ 20	VREF20	6020	155/-140	190/285	-380	1580	455	-280	395
TRAILING EDGE ASYMMETRY 5<FLAPS<20	VREF30+30	6900	180/-155	230/345	-400	1645	480	-300	405
TRAILING EDGE ASYMMETRY FLAPS ≤ 5	VREF30+40	7310	190/-165	250/365	-410	1675	490	-305	400
TRAILING EDGE FLAP DISAGREE	VREF20	6020	155/-140	190/285	-380	1580	455	-280	395

\* Reference distance assumes sea level, standard day with no wind or slope.

Assumes maximum manual braking and maximum reverse thrust when available on operating engine(s). Actual (unfactored) distances are shown.

Includes distance from 50 ft above threshold (1000 ft of air distance).

\*\*\* For landing distance at or below 8000 ft pressure altitude, apply the STD adjustment. For altitudes higher than 8000 ft, first apply the STD adjustment to derive a new reference landing distance for 8000 ft, then apply HIGH adjustment to this new reference distance.





**ADVISORY INFORMATION**

**Recommended Brake Cooling Schedule  
Adjusted Brake Energy Per Brake (Millions of Foot Pounds)  
No Reverse Thrust**

EVENT		REFERENCE BRAKE ENERGY PER BRAKE (MILLIONS OF FOOT POUNDS)										
		10	12	14	16	18	20	22	24	26	28	30
RTO MAX MAN		10	12	14	16	18	20	22	24	26	28	30
LANDING	MAX MAN	9.2	11.2	13.1	15.0	17.0	18.9	20.9	22.8	24.7	26.7	28.6
	MAX AUTO	8.9	10.8	12.6	14.4	16.3	18.1	19.9	21.7	23.5	25.3	27.2
	AUTOBRAKE 4	8.8	10.6	12.3	14.0	15.7	17.4	19.1	20.8	22.5	24.2	26.0
	AUTOBRAKE 3	8.7	10.4	12.0	13.7	15.3	16.9	18.4	20.0	21.6	23.2	24.8
	AUTOBRAKE 2	8.6	10.2	11.7	13.2	14.7	16.2	17.7	19.1	20.6	22.0	23.5
AUTOBRAKE 1		8.4	9.8	11.3	12.6	14.0	15.3	16.6	17.8	19.1	20.4	21.7

**Two Engine Reverse**

EVENT		REFERENCE BRAKE ENERGY PER BRAKE (MILLIONS OF FOOT POUNDS)										
		10	12	14	16	18	20	22	24	26	28	30
RTO MAX MAN		10	12	14	16	18	20	22	24	26	28	30
LANDING	MAX MAN	7.6	9.2	10.8	12.5	14.2	15.9	17.6	19.3	21.0	22.6	24.2
	MAX AUTO	5.0	6.3	7.6	8.9	10.2	11.5	12.9	14.2	15.6	16.9	18.3
	AUTOBRAKE 4	3.4	4.3	5.3	6.2	7.2	8.2	9.2	10.2	11.3	12.3	13.5
	AUTOBRAKE 3	2.4	3.0	3.6	4.2	4.8	5.5	6.2	6.9	7.7	8.4	9.3
	AUTOBRAKE 2	1.9	2.2	2.5	2.9	3.2	3.6	4.0	4.5	4.9	5.4	5.9
AUTOBRAKE 1		1.5	1.7	1.9	2.1	2.3	2.5	2.8	3.0	3.2	3.5	3.7

**Cooling Time (Minutes)**

		ADJUSTED BRAKE ENERGY PER BRAKE (MILLIONS OF FOOT POUNDS)								
		8 & BELOW	9	10	12	14	16	17	18 TO 27	28 & ABOVE
INFLIGHT GEAR DOWN	NO SPECIAL PROCEDURE	CAUTION	1	2	4	5	7	7	FUSE PLUG MELT ZONE	
	REQUIRED		10	20	38	51	62	66		
GROUND										
BTMS	UP TO 2		2	2	3	3	4	5	5 TO 8	8 & ABOVE

Observe maximum quick turnaround limit.

Table shows energy per brake added by a single stop with all brakes operating. Energy is assumed to be equally distributed among the operating brakes. Total energy is the sum of residual energy plus energy added.

Add 0.65 million foot pounds per brake for each taxi mile.

For one brake deactivated, increase brake energy by 15 percent.

When in caution zone, wheel fuse plugs may melt. Delay takeoff and inspect after one hour. If overheat occurs after takeoff, extend gear soon for at least 8 minutes.

When in fuse plug melt zone, clear runway immediately. Unless required, do not set parking brake. Do not attempt to taxi for one hour. Tire, wheel and brake replacement may be required. If overheat occurs after takeoff, extend gear soon for at least 12 minutes.

Brake temperature monitor system (BTMS) indication on EICAS may be used to 10 to 15 minutes after airplane has come to a complete stop, or inflight with gear retracted, to determine recommended cooling schedule.

**Performance Inflight**  
**Engine Inoperative**

**Chapter PI**  
**Section 23**

**ENGINE INOP**

**Initial Max Continuous EPR**  
**Based on engine bleed for one pack on**

PRESSURE ALTITUDE (FT)		CRUISE MACH NUMBER		
		.72	.76	.80
41000	EPR	1.56	1.52	1.48
	MAX TAT (SAT)	-23 (-46)	-20 (-46)	-17 (-46)
	EPR CORR	0.12	0.12	0.12
39000	EPR	1.56	1.52	1.48
	MAX TAT (SAT)	-23 (-46)	-20 (-46)	-17 (-46)
	EPR CORR	0.12	0.12	0.12
37000	EPR	1.57	1.53	1.49
	MAX TAT (SAT)	-23 (-46)	-20 (-46)	-17 (-46)
	EPR CORR	0.12	0.12	0.12
35000	EPR	1.54	1.50	1.46
	MAX TAT (SAT)	-21 (-44)	-18 (-44)	-15 (-44)
	EPR CORR	0.12	0.12	0.12
33000	EPR	1.49	1.45	1.42
	MAX TAT (SAT)	-16 (-40)	-13 (-40)	-11 (-41)
	EPR CORR	0.12	0.12	0.12
31000	EPR	1.44	1.41	1.38
	MAX TAT (SAT)	-12 (-36)	-9 (-36)	-6 (-36)
	EPR CORR	0.10	0.10	0.10

Decrease EPR by the EPR CORR for every 10°C above the MAX TAT shown.

**ENGINE INOP**

**Max Continuous EPR**

**41000 FT to 22000 FT Pressure Altitudes**

**Based on engine bleed for one pack on and anti-ice off**

PRESSURE ALTITUDE (FT)		KIAS					MACH NUMBER					
		180	200	220	240	260	.70	.72	.74	.76	.78	.80
41000	EPR		1.57	1.53	1.47	1.42	1.57	1.56	1.54	1.52	1.50	1.48
	MAX TAT		-25	-21	-17	-12	-24	-23	-22	-20	-19	-17
	EPR CORR		0.12	0.12	0.12	0.12	0.12	0.12	0.12	0.12	0.12	0.12
39000	EPR		1.57	1.56	1.51	1.45	1.57	1.56	1.54	1.52	1.50	1.48
	MAX TAT		-27	-23	-19	-15	-24	-23	-22	-20	-19	-17
	EPR CORR		0.12	0.12	0.12	0.12	0.12	0.12	0.12	0.12	0.12	0.12
37000	EPR		1.57	1.57	1.54	1.49	1.57	1.57	1.55	1.53	1.51	1.49
	MAX TAT		-28	-25	-21	-17	-24	-23	-22	-20	-19	-17
	EPR CORR		0.12	0.12	0.12	0.12	0.12	0.12	0.12	0.12	0.12	0.12
35000	EPR		1.57	1.57	1.54	1.49	1.56	1.54	1.52	1.50	1.48	1.46
	MAX TAT		-28	-24	-21	-17	-22	-21	-19	-18	-16	-15
	EPR CORR		0.12	0.12	0.12	0.12	0.12	0.12	0.12	0.12	0.12	0.12
33000	EPR		1.57	1.56	1.52	1.47	1.51	1.49	1.47	1.45	1.44	1.42
	MAX TAT		-25	-22	-19	-15	-18	-16	-15	-13	-12	-11
	EPR CORR		0.12	0.12	0.12	0.12	0.12	0.12	0.12	0.12	0.12	0.12
31000	EPR		1.56	1.53	1.49	1.45	1.46	1.44	1.43	1.41	1.40	1.38
	MAX TAT		-22	-19	-16	-13	-13	-12	-10	-9	-8	-6
	EPR CORR		0.10	0.10	0.10	0.10	0.10	0.10	0.10	0.10	0.10	0.10
29000	EPR		1.56	1.52	1.48	1.45	1.44	1.42	1.40	1.39	1.37	1.35
	MAX TAT		-19	-16	-13	-10	-9	-7	-6	-5	-3	-2
	EPR CORR		0.09	0.09	0.09	0.09	0.09	0.09	0.09	0.09	0.09	0.09
27000	EPR	1.57	1.56	1.53	1.49	1.46	1.43	1.41	1.39	1.37	1.36	1.34
	MAX TAT	-18	-16	-13	-11	-8	-5	-3	-2	0	1	3
	EPR CORR	0.09	0.09	0.09	0.09	0.09	0.09	0.09	0.09	0.09	0.09	0.09
25000	EPR	1.57	1.56	1.53	1.50	1.47	1.41	1.40	1.38	1.36	1.35	1.33
	MAX TAT	-15	-13	-10	-8	-5	0	1	3	4	6	7
	EPR CORR	0.09	0.09	0.09	0.09	0.09	0.09	0.09	0.09	0.09	0.09	0.09
22000	EPR	1.57	1.55	1.53	1.51	1.48	1.40	1.38	1.36	1.35	1.33	
	MAX TAT	-10	-8	-6	-3	-1	6	8	9	11	12	
	EPR CORR	0.08	0.08	0.08	0.08	0.08	0.08	0.08	0.08	0.08	0.08	

Decrease EPR by the EPR CORR for every 10°C above the MAX TAT shown.

**EPR Adjustments for Engine Bleed**

BLEED CONFIGURATION	PRESSURE ALTITUDE (FT)						
	0	8000	8001	10000	20000	30000	40000
PACKS OFF	0.01	0.01	0.01	0.01	0.02	0.03	0.04
ENGINE ANTI-ICE ON	0.00	0.00	-0.03	-0.03	-0.03	-0.04	-0.07
ENGINE & WING ANTI-ICE ON	-0.02	-0.02	-0.05	-0.06	-0.06	-0.08	-0.13

**ENGINE INOP**

**Max Continuous EPR**

**20000 FT to Sea Level Pressure Altitudes**

**Based on engine bleed for one pack on and anti-ice off**

PRESSURE ALTITUDE (FT)		KIAS					MACH NUMBER					
		180	200	220	240	260	.70	.72	.74	.76	.78	.80
20000	EPR	1.57	1.55	1.53	1.51	1.48	1.39	1.37	1.36			
	MAX TAT	-6	-5	-3	0	2	11	12	14			
	EPR CORR	0.08	0.08	0.08	0.08	0.08	0.08	0.08	0.08			
18000	EPR	1.55	1.53	1.51	1.48	1.46	1.36	1.34				
	MAX TAT	-3	-1	1	3	5	15	17				
	EPR CORR	0.08	0.08	0.08	0.08	0.08	0.08	0.08				
16000	EPR	1.53	1.51	1.49	1.46	1.44	1.33					
	MAX TAT	0	2	4	6	8	19					
	EPR CORR	0.07	0.07	0.07	0.07	0.07	0.07					
14000	EPR	1.50	1.49	1.47	1.44	1.42						
	MAX TAT	4	6	7	9	11						
	EPR CORR	0.07	0.07	0.07	0.07	0.07						
12000	EPR	1.48	1.46	1.45	1.43	1.40						
	MAX TAT	8	9	11	12	14						
	EPR CORR	0.07	0.07	0.07	0.07	0.07						
10000	EPR	1.46	1.44	1.43	1.41	1.39						
	MAX TAT	11	13	14	16	18						
	EPR CORR	0.06	0.06	0.06	0.06	0.06						
5000	EPR	1.40	1.39	1.33	1.36	1.35						
	MAX TAT	20	21	23	24	26						
	EPR CORR	0.05	0.05	0.05	0.05	0.05						
1500	EPR	1.35	1.34	1.30	1.31	1.30						
	MAX TAT	27	28	29	30	32						
	EPR CORR	0.05	0.05	0.05	0.05	0.05						
0	EPR	1.33	1.32	1.30	1.29	1.28						
	MAX TAT	29	30	32	33	34						
	EPR CORR	0.04	0.04	0.04	0.04	0.04						

Decrease EPR by the EPR CORR for every 10°C above the MAX TAT shown.

**EPR Adjustments for Engine Bleed**

BLEED CONFIGURATION	PRESSURE ALTITUDE (FT)						
	0	8000	8001	10000	20000	30000	40000
PACKS OFF	0.01	0.01	0.01	0.01	0.02	0.03	0.04
ENGINE ANTI-ICE ON	0.00	0.00	-0.03	-0.03	-0.03	-0.04	-0.07
ENGINE & WING ANTI-ICE ON	-0.02	-0.02	-0.05	-0.06	-0.06	-0.08	-0.13

**ENGINE INOP**

**MAX CONTINUOUS THRUST**

**Driftdown Speed/Level Off Altitude**

100 ft/min residual rate of climb

Includes APU fuel burn

WEIGHT (1000 LB)		OPTIMUM DRIFTDOWN SPEED (KIAS)	LEVEL OFF ALTITUDE (FT)		
START DRIFT DOWN	LEVEL OFF		ISA + 10°C & BELOW	ISA + 15°C	ISA + 20°C
260	250	249	18900	17400	15500
240	232	240	21100	20100	18600
220	213	230	23300	22300	21200
200	193	219	25600	24700	23600
180	174	208	28000	27200	26200
160	154	197	30900	30000	29000
140	135	187	33800	33400	32200

**Driftdown/LRC Cruise Range Capability**

Ground to Air Miles Conversion

AIR DISTANCE (NM)					GROUND DISTANCE (NM)	AIR DISTANCE (NM)				
HEADWIND COMPONENT (KTS)						TAILWIND COMPONENT (KTS)				
100	80	60	40	20	20	40	60	80	100	
282	260	242	226	212	200	189	179	170	162	155
563	521	484	452	425	400	378	358	341	325	310
839	777	724	677	636	600	568	539	512	489	467
1110	1030	961	901	847	800	758	720	685	654	625
1379	1282	1197	1124	1058	1000	948	901	858	820	784
1647	1533	1433	1346	1269	1200	1138	1082	1032	986	944
1916	1784	1670	1569	1480	1400	1328	1264	1205	1152	1103
2186	2037	1907	1792	1691	1600	1519	1445	1378	1317	1262
2461	2292	2146	2017	1902	1800	1708	1625	1550	1482	1419

**Driftdown/Cruise Fuel and Time**

AIR DIST (NM)	FUEL REQUIRED (1000 LB)						TIME (HR:MIN)
	WEIGHT AT START OF DRIFTDOWN (1000 LB)						
	160	180	200	220	240	260	
200	2.7	3.0	3.3	3.5	3.8	4.1	0:35
400	6.1	6.7	7.3	8.0	8.7	9.3	1:10
600	9.0	10.0	11.0	12.0	13.0	14.1	1:42
800	12.0	13.3	14.6	16.0	17.3	18.7	2:14
1000	14.9	16.6	18.2	19.9	21.5	23.2	2:45
1200	17.7	19.8	21.7	23.7	25.7	27.7	3:15
1400	20.6	22.9	25.2	27.5	29.8	32.1	3:46
1600	23.3	26.0	28.6	31.2	33.8	36.5	4:17
1800	26.1	29.1	32.0	34.9	37.8	40.8	4:50

Includes APU fuel burn.

Driftdown at optimum driftdown speed and cruise at Long Range Cruise speed.

**ENGINE INOP**

**MAX CONTINUOUS THRUST**

**Long Range Cruise Altitude Capability**

**100 ft/min residual rate of climb**

WEIGHT (1000 LB)	PRESSURE ALTITUDE (FT)		
	ISA + 10°C & BELOW	ISA + 15°C	ISA + 20°C
260	12200	8100	5100
250	14700	10300	7100
240	16400	12700	9100
230	18300	15000	11200
220	20000	17400	13700
210	21200	19700	16000
200	22300	21100	18600
190	23600	22400	20700
180	24900	23700	22100
170	26200	25100	23500
160	27500	26500	25100
150	29000	28000	26600
140	30800	29500	28300
130	33100	31400	30000
120	35100	33900	32000

With engine anti-ice on, decrease altitude capability by 2600 ft.

With engine and wing anti-ice on, decrease altitude capability by 6600 ft.

**ENGINE INOP**

**MAX CONTINUOUS THRUST**

**Long Range Cruise Control**

WEIGHT (1000 LB)		PRESSURE ALTITUDE (1000 FT)								
		10	14	18	21	23	25	27	29	31
260	EPR	1.27	1.34							
	MACH	.598	.621							
	KIAS	332	321							
	FF/ENG	10076	9797							
240	EPR	1.24	1.30	1.39						
	MACH	.582	.611	.633						
	KIAS	323	316	303						
	FF/ENG	9361	9173	8859						
220	EPR	1.21	1.27	1.34	1.42					
	MACH	.561	.596	.620	.642					
	KIAS	311	308	297	290					
	FF/ENG	8560	8495	8158	8155					
200	EPR	1.18	1.24	1.30	1.36	1.42				
	MACH	.532	.576	.608	.624	.639				
	KIAS	295	297	291	281	277				
	FF/ENG	7706	7770	7540	7365	7396				
180	EPR	1.15	1.20	1.26	1.32	1.36	1.42			
	MACH	.498	.549	.589	.611	.621	.635			
	KIAS	276	282	281	275	269	264			
	FF/ENG	6813	6942	6872	6746	6640	6629			
160	EPR	1.13	1.17	1.22	1.27	1.31	1.35	1.40		
	MACH	.473	.511	.561	.590	.606	.618	.630		
	KIAS	262	262	267	265	262	256	250		
	FF/ENG	6082	6079	6107	6080	6015	5925	5872		
140	EPR	1.11	1.14	1.18	1.22	1.26	1.29	1.33	1.38	1.45
	MACH	.451	.477	.520	.559	.580	.598	.612	.623	.639
	KIAS	249	245	247	251	250	247	243	237	233
	FF/ENG	5434	5286	5265	5322	5337	5280	5225	5142	5136
120	EPR	1.09	1.11	1.14	1.17	1.20	1.23	1.27	1.31	1.36
	MACH	.423	.451	.479	.511	.538	.564	.584	.602	.616
	KIAS	234	231	227	228	231	233	232	229	224
	FF/ENG	4765	4638	4460	4477	4527	4561	4555	4504	4426



**ENGINE INOP**

**MAX CONTINUOUS THRUST**

**Long Range Cruise Diversion Fuel and Time  
Ground to Air Miles Conversion**

AIR DISTANCE (NM)					GROUND DISTANCE (NM)	AIR DISTANCE (NM)				
HEADWIND COMPONENT (KTS)						TAILWIND COMPONENT (KTS)				
100	80	60	40	20		20	40	60	80	100
286	264	244	227	213	200	191	182	174	167	160
571	527	488	455	426	400	381	364	348	334	322
859	792	733	683	639	600	572	547	524	502	483
1148	1059	979	911	853	800	763	729	698	669	644
1440	1326	1226	1140	1066	1000	954	912	873	837	804
1733	1595	1473	1370	1280	1200	1144	1093	1046	1003	965
2029	1866	1721	1599	1494	1400	1335	1275	1220	1170	1125
2325	2137	1970	1830	1708	1600	1526	1457	1394	1336	1284
2623	2409	2220	2061	1923	1800	1716	1638	1567	1502	1443

**Reference Fuel and Time Required at Check Point**

AIR DIST (NM)	PRESSURE ALTITUDE (1000 FT)									
	10		14		18		22		28	
	FUEL (1000 LB)	TIME (HR:MIN)	FUEL (1000 LB)	TIME (HR:MIN)	FUEL (1000 LB)	TIME (HR:MIN)	FUEL (1000 LB)	TIME (HR:MIN)	FUEL (1000 LB)	TIME (HR:MIN)
200	4.3	0:41	3.8	0:39	3.4	0:38	3.1	0:37	2.7	0:35
400	8.9	1:17	8.2	1:12	7.4	1:10	6.9	1:09	6.5	1:04
600	13.5	1:53	12.4	1:46	11.4	1:42	10.7	1:40	10.2	1:33
800	18.0	2:30	16.7	2:20	15.4	2:15	14.4	2:12	13.9	2:02
1000	22.4	3:08	20.8	2:55	19.3	2:47	18.1	2:44	17.5	2:31
1200	26.8	3:46	24.9	3:30	23.1	3:20	21.8	3:16	21.0	3:01
1400	31.2	4:25	29.0	4:06	27.0	3:54	25.4	3:48	24.5	3:31
1600	35.5	5:04	33.1	4:42	30.7	4:27	29.0	4:20	27.9	4:02
1800	39.7	5:43	37.0	5:18	34.5	5:01	32.5	4:52	31.3	4:32

**Fuel Required Adjustment (1000 LB)**

REFERENCE FUEL REQUIRED (1000 LB)	WEIGHT AT CHECK POINT (1000 LB)					
	160	180	200	220	240	260
5	-0.4	-0.2	0.0	0.4	0.8	2.0
10	-0.9	-0.5	0.0	0.8	1.8	3.9
15	-1.4	-0.7	0.0	1.3	2.7	5.6
20	-1.9	-1.0	0.0	1.7	3.6	7.2
25	-2.4	-1.2	0.0	2.2	4.5	8.5
30	-2.9	-1.5	0.0	2.6	5.4	9.7
35	-3.4	-1.7	0.0	3.0	6.2	10.7
40	-3.9	-2.0	0.0	3.4	7.0	11.5
45	-4.4	-2.2	0.0	3.8	7.8	12.0

Includes APU fuel burn.

**ENGINE INOP**

**MAX CONTINUOUS THRUST**

**Holding  
Flaps Up**

WEIGHT (1000 LB)		PRESSURE ALTITUDE (FT)						
		1500	5000	10000	15000	20000	25000	30000
260	EPR	1.16	1.20	1.26	1.35			
	KIAS	241	241	242	243			
	FF/ENG	8460	8430	8430	8440			
240	EPR	1.15	1.18	1.23	1.31	1.43		
	KIAS	231	232	233	234	235		
	FF/ENG	7800	7760	7730	7710	7910		
220	EPR	1.13	1.16	1.21	1.27	1.38		
	KIAS	221	222	223	224	225		
	FF/ENG	7140	7100	7050	7020	7100		
200	EPR	1.12	1.14	1.18	1.24	1.33	1.47	
	KIAS	213	213	213	213	214	215	
	FF/ENG	6590	6450	6390	6320	6360	6640	
180	EPR	1.10	1.12	1.15	1.21	1.28	1.39	
	KIAS	205	205	205	205	205	205	
	FF/ENG	6020	5870	5760	5670	5690	5780	
160	EPR	1.08	1.10	1.13	1.17	1.23	1.32	1.48
	KIAS	197	197	197	197	197	197	197
	FF/ENG	5420	5330	5130	5040	5020	5070	5270
140	EPR	1.07	1.08	1.11	1.14	1.19	1.26	1.38
	KIAS	188	188	188	188	188	188	188
	FF/ENG	4820	4740	4560	4430	4400	4420	4480
120	EPR	1.06	1.07	1.09	1.11	1.15	1.21	1.30
	KIAS	179	179	179	179	179	179	179
	FF/ENG	4230	4160	4000	3860	3800	3800	3870

This table includes 5% additional fuel for holding in a racetrack pattern.

**Performance Inflight**  
**Alternate Thrust Setting**

**Chapter PI**  
**Section 24**

**ALTERNATE THRUST SETTING**

**Takeoff Performance**

PERFORMANCE LIMIT	WEIGHT ADJUSTMENT (1000 LB)			
	FLAPS 1	FLAPS 5	FLAPS 15	FLAPS 20
FIELD	-10.3	-10.3	-10.4	-11.0
TIRE SPEED	-1.4	-1.4	-1.4	-1.4
CLIMB	-18.5	-17.5	-16.9	-15.7
OBSTACLE	-19.1	-18.2	-17.4	-16.4

**Takeoff Speeds**

TAKEOFF SPEEDS	TAKEOFF SPEED ADJUSTMENT (KTS)
V1	+2
VR	+1
V2	0

**Enroute Performance**

PERFORMANCE LIMIT	WEIGHT ADJUSTMENT (1000 LB)
ENROUTE CLIMB	-13.8

**Landing Performance**

PERFORMANCE LIMIT	WEIGHT ADJUSTMENT (1000 LB)	
	FLAPS 15/25	FLAPS 20/30
APPROACH/LANDING CLIMB	-19.1	-17.5

**ALTERNATE THRUST SETTING**

**Takeoff %N1**

Based on engine bleed for packs on, engine anti-ice on or off and wing anti-ice off

AIRPORT OAT		AIRPORT PRESSURE ALTITUDE (FT)									
°F	°C	-1000	0	1000	2000	3000	4000	5000	6000	7000	8000
131	55	84.6	84.6	84.6	84.6	84.6	84.6	84.6	84.6	84.6	84.6
122	50	86.0	86.0	86.0	86.0	86.0	86.0	86.0	86.0	86.0	86.0
113	45	87.3	87.4	87.4	87.4	87.4	87.4	87.4	87.4	87.4	87.4
104	40	87.9	88.0	88.4	88.8	89.1	89.1	89.1	89.1	89.1	89.1
95	35	88.4	88.5	89.0	89.4	89.9	90.2	90.4	90.4	90.4	90.4
86	30	88.4	88.9	89.5	90.0	90.5	90.8	91.1	91.1	91.1	91.1
77	25	87.7	88.1	89.1	90.1	91.1	91.4	91.7	91.7	91.7	91.7
68	20	87.0	87.3	88.4	89.4	90.3	91.3	92.2	92.4	92.4	92.4
59	15	86.2	86.5	87.6	88.6	89.5	90.4	91.3	91.9	92.5	92.7
50	10	85.4	85.7	86.8	87.8	88.7	89.6	90.5	91.1	91.6	92.2
41	5	84.5	84.9	85.9	86.9	87.8	88.8	89.6	90.2	90.8	91.4
32	0	83.7	84.1	85.1	86.1	87.0	87.9	88.8	89.4	89.9	90.5
23	-5	82.9	83.2	84.3	85.3	86.1	87.1	87.9	88.5	89.1	89.6
14	-10	82.0	82.4	83.5	84.4	85.3	86.2	87.0	87.7	88.2	88.7
5	-15	81.2	81.6	82.6	83.6	84.4	85.4	86.2	86.8	87.3	87.8
-4	-20	80.4	80.8	81.8	82.8	83.6	84.5	85.3	85.9	86.4	87.0
-13	-25	79.5	80.0	81.0	81.9	82.7	83.7	84.5	85.1	85.6	86.1
-22	-30	78.7	79.1	80.2	81.1	81.9	82.8	83.6	84.2	84.7	85.2
-31	-35	77.9	78.3	79.4	80.3	81.0	82.0	82.7	83.3	83.8	84.3
-40	-40	77.0	77.5	78.5	79.4	80.2	81.1	81.9	82.5	82.9	83.4
-49	-45	76.2	76.6	77.7	78.6	79.4	80.3	81.0	81.6	82.1	82.6
-58	-50	75.4	75.8	76.9	77.8	78.5	79.4	80.2	80.7	81.2	81.7

**%N1 Adjustments for Engine Bleeds**

BLEED CONFIGURATION	AIRPORT PRESSURE ALTITUDE (FT)									
	-1000	0	1000	2000	3000	4000	5000	6000	7000	8000
PACKS OFF	0.6	0.6	0.6	0.6	0.6	0.6	0.6	0.6	0.6	0.6
WING ANTI-ICE ON	-1.0	-1.0	-1.0	-1.0	-1.0	-1.0	-1.0	-1.0	-1.0	-1.0

**ALTERNATE THRUST SETTING**

**Go-around %N1**

Based on engine bleed for packs on, engine anti-ice on or off and wing anti-ice off

AIRPORT OAT		TAT (°C)	AIRPORT PRESSURE ALTITUDE (FT)									
°F	°C		-1000	0	1000	2000	3000	4000	5000	6000	7000	8000
131	55	58	85.0	84.9	84.9	84.8	84.8	84.8	84.8	84.7	84.7	84.7
122	50	53	86.1	86.1	86.1	86.1	86.0	86.0	86.0	86.0	86.0	85.9
113	45	48	87.2	87.3	87.3	87.3	87.3	87.3	87.3	87.3	87.3	87.2
104	40	43	87.8	87.9	88.2	88.5	88.9	88.9	88.9	88.9	88.9	88.8
95	35	37	88.4	88.5	88.9	89.2	89.7	90.0	90.1	90.1	90.1	90.1
86	30	32	88.3	88.9	89.5	89.9	90.4	90.7	91.1	91.1	91.1	91.1
77	25	27	87.5	88.1	89.0	90.0	91.0	91.4	91.8	91.8	91.8	91.8
68	20	22	86.8	87.3	88.3	89.3	90.2	91.1	92.1	92.4	92.4	92.5
59	15	17	86.0	86.5	87.5	88.5	89.4	90.3	91.2	91.9	92.3	92.7
50	10	12	85.1	85.7	86.7	87.7	88.6	89.5	90.4	91.0	91.5	92.1
41	5	7	84.3	84.9	85.8	86.9	87.8	88.7	89.5	90.2	90.7	91.3
32	0	2	83.5	84.0	85.0	86.0	86.9	87.9	88.7	89.3	89.8	90.4
23	-5	-3	82.7	83.2	84.2	85.2	86.1	87.0	87.8	88.4	89.0	89.5
14	-10	-8	81.9	82.4	83.4	84.4	85.2	86.2	87.0	87.6	88.1	88.6
5	-15	-13	81.0	81.6	82.6	83.5	84.4	85.3	86.1	86.7	87.2	87.8
-4	-20	-18	80.2	80.7	81.7	82.7	83.5	84.5	85.2	85.9	86.4	86.9
-13	-25	-23	79.4	79.9	80.9	81.9	82.7	83.6	84.4	85.0	85.5	86.0
-22	-30	-28	78.6	79.1	80.1	81.0	81.8	82.8	83.5	84.1	84.6	85.1
-31	-35	-33	77.8	78.3	79.3	80.2	81.0	81.9	82.7	83.3	83.7	84.2
-40	-40	-38	76.9	77.4	78.5	79.4	80.2	81.1	81.8	82.4	82.9	83.4
-49	-45	-43	76.1	76.6	77.6	78.5	79.3	80.2	81.0	81.5	82.0	82.5
-58	-50	-48	75.3	75.8	76.8	77.7	78.4	79.4	80.1	80.7	81.1	81.6

**%N1 Adjustments for Engine Bleeds**

BLEED CONFIGURATION	AIRPORT PRESSURE ALTITUDE (FT)									
	-1000	0	1000	2000	3000	4000	5000	6000	7000	8000
PACKS OFF	0.6	0.6	0.6	0.6	0.6	0.6	0.6	0.6	0.6	0.6
WING ANTI-ICE ON	-1.0	-1.0	-1.0	-1.0	-1.0	-1.0	-1.0	-1.0	-1.0	-1.0

**ALTERNATE THRUST SETTING**

**Max Climb %N1**

**Based on engine bleed for packs on and anti-ice off**

TAT (°C)	PRESSURE ALTITUDE (1000 FT)/SPEED (KIAS OR MACH)								
	0	5	10	15	20	25	30	35	40
	250	250	250	290	290	290	290	.78	.78
60	83.4	85.4	85.4	85.8	84.9	82.7	80.4	80.2	80.1
50	84.6	86.6	86.8	87.1	86.3	84.1	81.7	81.5	81.3
40	85.9	87.8	88.0	88.4	87.6	85.5	83.0	82.8	82.6
30	86.2	89.0	89.2	89.5	88.8	86.8	84.2	83.9	83.7
20	84.8	88.9	90.3	90.5	89.7	87.8	85.3	85.0	84.7
10	83.3	87.4	89.5	90.8	90.9	89.1	86.6	86.4	86.2
0	81.9	85.8	87.9	89.2	90.5	90.6	88.2	88.0	87.7
-10	80.3	84.2	86.3	87.5	88.8	89.1	88.5	89.5	89.2
-20	78.8	82.6	84.6	85.9	87.1	87.3	86.8	89.9	90.6
-30	77.2	81.0	82.9	84.1	85.4	85.6	85.0	88.1	88.8
-40	75.6	79.3	81.2	82.4	83.6	83.8	83.3	86.3	86.9
-50	74.0	77.6	79.5	80.6	81.8	82.0	81.5	84.4	85.0

**%N1 Adjustments for Engine Bleeds**

BLEED CONFIGURATION	PRESSURE ALTITUDE (1000 FT)								
	0	5	10	15	20	25	30	35	40
PACKS OFF	0.5	0.4	0.4	0.5	0.7	0.8	1.0	1.2	1.4
ENGINE ANTI-ICE ON	0.0	0.0	-1.2	-1.2	-1.2	-1.3	-1.4	-1.7	-2.1
ENGINE & WING ANTI-ICE ON	-0.9	-1.0	-2.2	-2.3	-2.3	-2.4	-2.7	-3.2	-4.0

**ALTERNATE THRUST SETTING**

**Max Cruise %N1**

Based on engine bleed for packs on and anti-ice off

TAT (°C)	PRESSURE ALTITUDE (1000 FT)								
	25	27	29	31	33	35	37	39	41
55	80.7	80.4	80.2	80.0	79.7	79.5	79.2	79.0	78.8
50	81.8	81.6	81.4	81.2	81.0	80.8	80.6	80.3	80.2
45	82.5	82.4	82.2	82.0	81.9	81.7	81.5	81.4	81.2
40	83.1	82.9	82.8	82.6	82.5	82.3	82.2	82.1	81.9
35	83.7	83.5	83.4	83.2	83.1	82.9	82.8	82.6	82.5
30	84.2	84.0	83.9	83.8	83.6	83.5	83.3	83.2	83.1
25	84.7	84.5	84.4	84.3	84.2	84.0	83.9	83.8	83.7
20	85.2	85.0	84.9	84.8	84.6	84.5	84.4	84.3	84.2
15	85.6	85.5	85.4	85.3	85.1	85.0	84.9	84.3	84.7
10	85.9	85.8	85.7	85.6	85.5	85.4	85.3	85.2	85.1
5	85.7	86.1	86.1	86.0	85.9	85.8	85.7	85.6	85.5
0	85.0	85.8	86.4	86.3	86.2	86.1	86.0	85.9	85.9
-5	84.2	85.1	86.0	86.8	86.7	86.6	86.5	86.4	86.3
-10	83.4	84.3	85.2	86.2	87.2	87.1	87.0	86.9	86.9
-15	82.6	83.5	84.4	85.4	86.5	87.8	87.7	87.6	87.6
-20	81.8	82.6	83.6	84.6	85.7	86.9	87.6	87.5	87.5
-25	81.0	81.8	82.7	83.7	84.8	86.1	86.8	86.7	86.6
-30	80.2	81.0	81.9	82.9	84.0	85.2	85.9	85.8	85.7
-35	79.3	80.2	81.1	82.0	83.1	84.3	85.0	84.9	84.9
-40	78.5	79.3	80.2	81.2	82.2	83.4	84.1	84.0	84.0

**%N1 Adjustments for Engine Bleeds**

BLEED CONFIGURATION	PRESSURE ALTITUDE (1000 FT)								
	25	27	29	31	33	35	37	39	41
ENGINE ANTI-ICE ON	-1.4	-1.4	-1.4	-1.4	-1.4	-1.4	-1.4	-1.4	-1.4
ENGINE & WING ANTI-ICE ON	-2.6	-2.6	-2.6	-2.6	-2.6	-2.6	-2.6	-2.6	-2.6

**ALTERNATE THRUST SETTING**

**ENGINE INOP**

**Initial Max Continuous %N1**

**Based on .80M, engine bleed for one pack on and anti-ice off**

TAT (°C)	PRESSURE ALTITUDE (1000 FT)								
	27	29	31	33	35	37	39	41	43
20	86.8	85.8	85.2	85.1	85.0	84.9	84.8	84.7	84.5
15	87.4	86.4	85.9	85.8	85.7	85.6	85.5	85.3	85.2
10	88.1	87.1	86.6	86.5	86.4	86.3	86.2	86.1	86.0
5	88.9	87.9	87.4	87.3	87.2	87.1	87.0	86.9	86.8
0	88.7	88.7	88.1	88.1	88.0	87.9	87.8	87.7	87.6
-5	87.9	88.4	88.9	88.8	88.7	88.6	88.5	88.5	88.4
-10	87.1	87.5	88.4	89.6	89.5	89.4	89.3	89.2	89.1
-15	86.3	86.7	87.6	88.9	90.3	90.2	90.1	90.0	89.9
-20	85.4	85.9	86.7	88.0	89.4	90.1	90.0	89.9	89.8
-25	84.6	85.0	85.9	87.2	88.5	89.2	89.1	89.0	88.9
-30	83.7	84.1	85.0	86.3	87.6	88.3	88.2	88.1	88.0
-35	82.9	83.3	84.1	85.4	86.7	87.4	87.3	87.2	87.1
-40	82.0	82.4	83.2	84.5	85.8	86.5	86.4	86.3	86.2

**%N1 Adjustments for Engine Bleed**

BLEED CONFIGURATION	PRESSURE ALTITUDE (1000 FT)								
	27	29	31	33	35	37	39	41	43
PACKS OFF	0.9	1.0	1.0	1.1	1.2	1.3	1.4	1.4	1.5
ENGINE ANTI-ICE ON	-1.3	-1.4	-1.5	-1.6	-1.7	-1.9	-2.0	-2.3	-2.8
ENGINE & WING ANTI-ICE ON	-2.5	-2.6	-2.8	-3.0	-3.2	-3.6	-3.8	-4.4	-5.3



**ALTERNATE THRUST SETTING**  
**ENGINE INOP**

**Max Continuous %N1**

Based on engine bleed for one pack on and anti-ice off

37000 FT to 20000 FT Pressure Altitudes

37000 FT PRESS ALT		TAT (°C)											
KIAS	M	-40	-35	-30	-25	-20	-15	-10	-5	0	5	10	15
200	.63	92.1	93.0	94.0	93.2	91.7	90.5	89.4	88.6	87.8	87.1	86.3	85.6
220	.69	89.9	90.8	91.8	92.7	91.3	90.2	89.3	88.6	87.9	87.1	86.3	85.6
240	.75	87.9	88.9	89.8	90.7	91.1	90.2	89.3	88.6	87.9	87.1	86.3	85.6
260	.80	86.4	87.4	88.3	89.2	90.1	90.2	89.4	88.6	87.9	87.1	86.3	85.6
33000 FT PRESS ALT		TAT (°C)											
KIAS	M	-40	-35	-30	-25	-20	-15	-10	-5	0	5	10	15
200	.58	90.4	91.4	92.3	93.3	91.9	90.6	89.6	88.7	87.9	87.2	86.4	85.7
220	.63	89.0	89.9	90.9	91.8	91.9	90.6	89.6	88.8	88.0	87.3	86.5	85.8
240	.68	87.2	88.2	89.1	90.0	90.9	90.4	89.5	88.8	88.0	87.3	86.5	85.8
260	.74	85.9	86.8	87.7	88.6	89.5	90.3	89.5	88.8	88.1	87.3	86.5	85.8
29000 FT PRESS ALT		TAT (°C)											
KIAS	M	-40	-35	-30	-25	-20	-15	-10	-5	0	5	10	15
200	.53	87.9	88.8	89.7	90.6	91.5	90.9	89.9	89.0	88.3	87.6	87.0	86.3
220	.58	87.2	88.1	89.0	90.0	90.9	91.2	90.2	89.3	88.5	87.8	87.1	86.4
240	.63	86.1	87.0	87.9	88.8	89.7	90.6	90.2	89.4	88.6	87.9	87.1	86.4
260	.68	84.9	85.8	86.7	87.5	88.4	89.3	90.1	89.4	88.7	87.9	87.1	86.4
25000 FT PRESS ALT		TAT (°C)											
KIAS	M	-40	-35	-30	-25	-20	-15	-10	-5	0	5	10	15
200	.49	87.1	88.0	89.0	89.9	90.8	91.7	91.6	90.8	90.1	89.5	88.9	88.3
220	.53	86.5	87.4	88.3	89.2	90.1	91.0	91.8	91.0	90.2	89.6	88.9	88.3
240	.58	85.9	86.8	87.7	88.6	89.5	90.4	91.3	91.2	90.4	89.7	89.1	88.4
260	.63	85.1	86.0	86.9	87.8	88.7	89.6	90.4	91.3	90.5	89.8	89.1	88.4
22000 FT PRESS ALT		TAT (°C)											
KIAS	M	-15	-10	-5	0	5	10	15	20	25	30	35	
200	.46	91.1	91.9	91.9	91.2	90.6	90.0	89.4	88.9	88.3	87.7	87.0	
240	.55	89.8	90.7	91.6	91.4	90.7	90.1	89.5	88.9	88.4	87.8	87.2	
280	.63	88.5	89.3	90.2	91.0	90.9	90.2	89.6	89.0	88.5	88.0	87.4	
20000 FT PRESS ALT		TAT (°C)											
KIAS	M	-15	-10	-5	0	5	10	15	20	25	30	35	
200	.44	90.7	91.6	92.4	91.9	91.3	90.7	90.2	89.6	89.1	88.4	87.8	
240	.53	89.5	90.4	91.2	92.0	91.4	90.8	90.2	89.7	89.2	88.6	88.0	
280	.61	88.4	89.2	90.1	90.9	91.6	90.9	90.3	89.7	89.3	88.8	88.2	

**%N1 Adjustments for Engine Bleed**

BLEED CONFIGURATION	PRESSURE ALTITUDE (1000 FT)					
	20	22	25	29	33	37
PACKS OFF	0.6	0.7	0.8	0.9	1.1	1.3
ENGINE ANTI-ICE ON	-1.2	-1.2	-1.2	-1.3	-1.5	-1.8
ENGINE & WING ANTI-ICE ON	-2.3	-2.3	-2.3	-2.5	-2.9	-3.4

**ALTERNATE THRUST SETTING**

**ENGINE INOP**

**Max Continuous %N1**

Based on engine bleed for one pack on and anti-ice off

18000 FT to 8000 FT Pressure Altitudes

18000 FT PRESS ALT												TAT (°C)	
CIAS	M	-15	-10	-5	0	5	10	15	20	25	30	35	
200	.42	90.0	90.9	91.7	92.2	91.6	91.0	90.5	89.9	89.4	88.8	88.1	
240	.51	88.9	89.7	90.6	91.4	91.6	91.0	90.5	90.0	89.4	88.9	88.3	
280	.59	87.8	88.7	89.5	90.3	91.2	91.2	90.6	90.1	89.6	89.1	88.5	
16000 FT PRESS ALT												TAT (°C)	
CIAS	M	-15	-10	-5	0	5	10	15	20	25	30	35	
200	.41	89.3	90.2	91.0	91.9	91.9	91.3	90.8	90.2	89.7	89.1	88.5	
240	.49	88.3	89.2	90.0	90.8	91.7	91.3	90.8	90.3	89.7	89.2	88.6	
280	.57	87.3	88.1	89.0	89.8	90.6	91.4	90.9	90.3	89.9	89.4	88.8	
14000 FT PRESS ALT												TAT (°C)	
CIAS	M	-15	-10	-5	0	5	10	15	20	25	30	35	
200	.39	88.5	89.3	90.2	91.0	91.8	91.4	90.9	90.3	89.7	89.1	88.5	
240	.47	87.6	88.4	89.3	90.1	90.9	91.5	90.9	90.4	89.9	89.3	88.7	
280	.54	86.6	87.4	88.2	89.1	89.9	90.7	91.0	90.5	90.0	89.4	88.9	
12000 FT PRESS ALT												TAT (°C)	
CIAS	M	-10	-5	0	5	10	15	20	25	30	35	40	
200	.38	88.2	89.1	89.9	90.7	91.3	90.7	90.2	89.6	89.0	88.4	87.7	
240	.45	87.5	88.4	89.2	90.0	90.8	90.9	90.4	89.8	89.2	88.6	88.0	
10000 FT PRESS ALT												TAT (°C)	
CIAS	M	-10	-5	0	5	10	15	20	25	30	35	40	
200	.36	87.2	88.0	88.9	89.7	90.5	90.6	90.1	89.4	88.8	88.2	87.5	
240	.43	86.6	87.5	88.3	89.1	89.9	90.7	90.3	89.8	89.2	88.6	88.0	
8000 FT PRESS ALT												TAT (°C)	
CIAS	M	-10	-5	0	5	10	15	20	25	30	35	40	
200	.35	86.2	87.0	87.8	88.6	89.4	90.2	89.9	89.3	88.7	88.0	87.3	
240	.42	85.8	86.6	87.4	88.2	89.0	89.7	90.3	89.7	89.1	88.5	87.9	

**%N1 Adjustments for Engine Bleed**

BLEED CONFIGURATION	PRESSURE ALTITUDE (1000 FT)					
	8	10	12	14	16	18
PACKS OFF	0.4	0.4	0.4	0.5	0.5	0.6
ENGINE ANTI-ICE ON	-1.2	-1.2	-1.2	-1.2	-1.2	-1.2
ENGINE & WING ANTI-ICE ON	-2.2	-2.2	-2.2	-2.2	-2.3	-2.3

**ALTERNATE THRUST SETTING**  
**ENGINE INOP**

**Max Continuous %N1**

Based on engine bleed for one pack on and anti-ice off

6000 FT to Sea Level Pressure Altitudes

6000 FT PRESS ALT		TAT (°C)										
KIAS	M	-10	-5	0	5	10	15	20	25	30	35	40
200	.34	85.2	86.0	86.8	87.6	88.4	89.1	89.8	89.2	88.5	87.9	87.2
240	.40	84.9	85.7	86.5	87.2	88.0	88.8	89.6	89.6	89.1	88.5	87.8
4000 FT PRESS ALT		TAT (°C)										
KIAS	M	-10	-5	0	5	10	15	20	25	30	35	40
200	.32	83.8	84.6	85.4	86.2	87.0	87.7	88.5	88.7	88.1	87.4	86.7
240	.39	83.6	84.4	85.2	85.9	86.7	87.5	88.2	89.0	88.6	88.0	87.4
2000 FT PRESS ALT		TAT (°C)										
KIAS	M	-10	-5	0	5	10	15	20	25	30	35	40
200	.31	82.2	83.0	83.8	84.5	85.3	86.0	86.8	87.5	87.3	86.6	85.9
240	.38	82.0	82.8	83.6	84.3	85.1	85.8	86.6	87.3	87.8	87.2	86.6
0 FT PRESS ALT		TAT (°C)										
KIAS	M	-10	-5	0	5	10	15	20	25	30	35	40
200	.30	80.5	81.3	82.1	82.8	83.6	84.3	85.0	85.7	86.5	85.9	85.1
240	.36	80.4	81.2	81.9	82.7	83.4	84.1	84.9	85.6	86.3	86.4	85.8

**%N1 Adjustments for Engine Bleed**

BLEED CONFIGURATION	PRESSURE ALTITUDE (1000 FT)			
	0	2	4	6
PACKS OFF	0.5	0.4	0.4	0.4
ENGINE ANTI-ICE ON	0.0	0.0	0.0	0.0
ENGINE & WING ANTI-ICE ON	-0.9	-0.9	-1.0	-1.0

Intentionally  
Blank

**Performance Inflight**  
**Gear Down**

**Chapter PI**  
**Section 25**

**GEAR DOWN**

**210 KIAS Max Climb EPR**

Based on engine bleed for packs on and anti-ice off

TAT (°C)	PRESSURE ALTITUDE (1000 FT)														
	0	5	10	12	14	16	18	20	22	24	26	28	30	32	34
55	1.18	1.17	1.16	1.16	1.15	1.14	1.14	1.13	1.11	1.10	1.09	1.07	1.06	1.04	1.03
50	1.19	1.19	1.18	1.18	1.17	1.16	1.15	1.14	1.13	1.12	1.11	1.09	1.08	1.06	1.05
45	1.21	1.21	1.20	1.19	1.19	1.18	1.17	1.16	1.15	1.14	1.12	1.11	1.10	1.08	1.07
40	1.23	1.22	1.21	1.21	1.20	1.20	1.19	1.18	1.17	1.16	1.14	1.13	1.12	1.10	1.09
35	1.25	1.24	1.23	1.23	1.22	1.22	1.21	1.20	1.19	1.18	1.17	1.15	1.14	1.12	1.11
30	1.26	1.26	1.25	1.25	1.24	1.24	1.23	1.22	1.21	1.20	1.19	1.18	1.16	1.15	1.14
25	1.26	1.29	1.28	1.27	1.27	1.26	1.25	1.25	1.24	1.22	1.21	1.20	1.19	1.17	1.16
20	1.26	1.30	1.30	1.30	1.29	1.29	1.28	1.27	1.26	1.25	1.24	1.23	1.21	1.20	1.19
15	1.26	1.30	1.33	1.33	1.32	1.31	1.31	1.30	1.29	1.28	1.27	1.25	1.24	1.23	1.22
10	1.26	1.30	1.34	1.35	1.35	1.34	1.34	1.33	1.32	1.31	1.30	1.28	1.27	1.26	1.25
5	1.26	1.30	1.34	1.36	1.37	1.38	1.37	1.36	1.35	1.34	1.33	1.32	1.30	1.29	1.28
0	1.26	1.30	1.34	1.36	1.37	1.39	1.40	1.40	1.39	1.37	1.36	1.35	1.34	1.33	1.32
-5	1.26	1.30	1.34	1.36	1.37	1.39	1.40	1.42	1.42	1.41	1.40	1.39	1.38	1.37	1.36
-10	1.26	1.30	1.34	1.36	1.37	1.39	1.40	1.42	1.44	1.46	1.45	1.44	1.43	1.42	1.41
-15	1.26	1.30	1.34	1.36	1.37	1.39	1.40	1.42	1.44	1.46	1.48	1.49	1.48	1.47	1.47
-20	1.26	1.30	1.34	1.36	1.37	1.39	1.40	1.42	1.44	1.46	1.48	1.50	1.53	1.54	1.53
-25	1.26	1.30	1.34	1.36	1.37	1.39	1.40	1.42	1.44	1.46	1.48	1.50	1.53	1.56	1.57
-30	1.26	1.30	1.34	1.36	1.37	1.39	1.40	1.42	1.44	1.46	1.48	1.50	1.53	1.56	1.57

**EPR Adjustments for Engine Bleeds**

BLEED CONFIGURATION	PRESSURE ALTITUDE (1000 FT)													
	0	5	10	12	16	18	22	24	26	28	30	32	34	
PACKS OFF	0.01	0.01	0.01	0.01	0.01	0.01	0.02	0.02	0.02	0.03	0.03	0.03	0.04	0.04
ENGINE ANTI-ICE ON	0.00	0.00	-0.03	-0.03	-0.03	-0.03	-0.03	-0.04	-0.04	-0.04	-0.04	-0.04	-0.05	-0.05
ENGINE & WING ANTI-ICE ON	-0.02	-0.02	-0.05	-0.06	-0.06	-0.06	-0.06	-0.07	-0.07	-0.07	-0.08	-0.08	-0.09	-0.10

**Long Range Cruise Altitude Capability**

WEIGHT (1000 LB)	PRESSURE ALTITUDE (FT)		
	ISA + 10°C & BELOW	ISA + 15°C	ISA + 20°C
260	15500	13600	10700
250	17200	15100	12800
240	18900	16900	14800
230	20700	18600	16500
220	22600	20300	18400
210	24800	22100	20200
200	27000	24100	22100
190	29200	26300	24000
180	31500	28700	26000
170	33300	31300	28300
160	34600	33600	31100
150	35700	35500	33500
140	36900	36900	35600
130	38200	38100	37000
120	39500	39400	38200

**GEAR DOWN**

**Long Range Cruise Control**

WEIGHT (1000 LB)		PRESSURE ALTITUDE (1000 FT)										
		10	14	18	21	23	25	27	29	31	33	35
260	EPR	1.20	1.25									
	MACH	.451	.483									
	KIAS	251	250									
	FF/ENG	7079	7051									
240	EPR	1.18	1.22	1.29								
	MACH	.434	.466	.506								
	KIAS	242	241	242								
	FF/ENG	6515	6477	6483								
220	EPR	1.16	1.20	1.25	1.31							
	MACH	.417	.449	.482	.517							
	KIAS	232	232	231	233							
	FF/ENG	5955	5928	5832	5934							
200	EPR	1.14	1.17	1.22	1.26	1.30	1.35	1.40				
	MACH	.400	.430	.462	.489	.514	.536	.553				
	KIAS	222	222	221	221	223	223	221				
	FF/ENG	5409	5371	5282	5290	5363	5394	5396				
180	EPR	1.12	1.15	1.19	1.23	1.26	1.30	1.35	1.40	1.47		
	MACH	.383	.409	.441	.466	.484	.508	.532	.550	.569		
	KIAS	213	211	210	210	209	211	212	210	208		
	FF/ENG	4907	4821	4741	4714	4722	4787	4828	4831	4854		
160	EPR	1.10	1.13	1.16	1.19	1.22	1.25	1.29	1.33	1.38	1.45	1.55
	MACH	.365	.389	.418	.442	.460	.477	.500	.525	.545	.564	.589
	KIAS	203	200	199	199	198	198	199	200	199	197	197
	FF/ENG	4431	4304	4198	4183	4176	4162	4210	4258	4246	4279	4440
140	EPR	1.08	1.11	1.13	1.16	1.18	1.21	1.24	1.27	1.32	1.37	1.43
	MACH	.344	.369	.396	.420	.437	.456	.475	.495	.517	.539	.563
	KIAS	191	190	188	188	188	188	188	188	188	188	188
	FF/ENG	3928	3828	3705	3692	3694	3693	3696	3713	3704	3717	3780
120	EPR	1.07	1.09	1.11	1.13	1.15	1.17	1.20	1.23	1.26	1.30	1.35
	MACH	.323	.349	.377	.400	.417	.434	.453	.472	.493	.514	.537
	KIAS	179	179	179	179	179	179	179	179	179	179	179
	FF/ENG	3456	3380	3325	3294	3291	3288	3287	3287	3267	3258	3258

**GEAR DOWN**

**Long Range Cruise Enroute Fuel and Time  
 Ground to Air Miles Conversion**

AIR DISTANCE (NM)					GROUND DISTANCE (NM)	AIR DISTANCE (NM)				
HEADWIND COMPONENT (KTS)						TAILWIND COMPONENT (KTS)				
100	80	60	40	20	20	40	60	80	100	
329	293	262	237	217	200	188	178	168	160	153
664	590	527	477	436	400	377	357	338	321	306
1002	889	792	716	654	600	566	534	506	481	459
1345	1192	1060	957	873	800	754	712	675	641	612
1693	1497	1330	1199	1092	1000	943	890	843	801	764
2045	1805	1601	1441	1312	1200	1131	1067	1010	960	915
2404	2118	1875	1685	1532	1400	1318	1244	1178	1118	1066
2768	2434	2150	1930	1753	1600	1506	1420	1344	1276	1216
3140	2756	2429	2177	1975	1800	1693	1597	1510	1432	1365

**Reference Fuel and Time Required at Check Point**

AIR DIST (NM)	PRESSURE ALTITUDE (1000 FT)									
	10		14		18		22		28	
	FUEL (1000 LB)	TIME (HR:MIN)	FUEL (1000 LB)	TIME (HR:MIN)	FUEL (1000 LB)	TIME (HR:MIN)	FUEL (1000 LB)	TIME (HR:MIN)	FUEL (1000 LB)	TIME (HR:MIN)
200	7.9	0:51	7.2	0:49	6.5	0:47	6.0	0:45	5.3	0:42
400	16.2	1:40	15.0	1:35	13.7	1:30	12.8	1:25	11.6	1:19
600	24.2	2:29	22.5	2:21	20.7	2:14	19.4	2:07	17.7	1:56
800	32.1	3:19	29.9	3:09	27.6	2:58	25.9	2:48	23.7	2:33
1000	39.8	4:10	37.1	3:57	34.3	3:43	32.2	3:31	29.6	3:11
1200	47.3	5:02	44.1	4:46	40.9	4:30	38.4	4:14	35.4	3:50
1400	54.7	5:55	51.0	5:36	47.3	5:17	44.5	4:58	41.0	4:29
1600	61.9	6:49	57.8	6:27	53.6	6:04	50.4	5:43	46.5	5:09
1800	69.0	7:45	64.4	7:19	59.7	6:53	56.2	6:28	51.9	5:50

**Fuel Required Adjustment (1000 LB)**

REFERENCE FUEL REQUIRED (1000 LB)	WEIGHT AT CHECK POINT (1000 LB)					
	160	180	200	220	240	260
10	-0.9	-0.5	0.0	0.8	1.7	2.6
20	-2.0	-1.0	0.0	1.6	3.4	5.3
30	-3.0	-1.5	0.0	2.3	5.0	7.8
40	-4.1	-2.0	0.0	3.0	6.5	10.1
50	-5.1	-2.6	0.0	3.6	7.8	12.2
60	-6.2	-3.1	0.0	4.2	8.9	14.1
70	-7.2	-3.6	0.0	4.8	9.9	15.8

**Descent at VREF30+80**

PRESSURE ALTITUDE (1000 FT)	5	10	15	17	19	21	23	25	27	29	31	33	35
DISTANCE (NM)	12	22	31	35	39	42	46	50	54	58	62	66	70
TIME (MINUTES)	7	9	12	13	14	14	15	16	17	18	18	19	20

**GEAR DOWN**

**Holding  
Flaps Up**

WEIGHT (1000 LB)		PRESSURE ALTITUDE (FT)						
		1500	5000	10000	15000	20000	25000	30000
260	EPR	1.12	1.14	1.19	1.25			
	KIAS	235	235	235	235			
	FF/ENG	7030	6940	6900	6850			
240	EPR	1.11	1.13	1.17	1.22	1.31		
	KIAS	228	228	228	228	228		
	FF/ENG	6590	6430	6380	6320	6370		
220	EPR	1.09	1.11	1.15	1.20	1.27		
	KIAS	220	220	220	220	220		
	FF/ENG	6130	5990	5880	5800	5830		
200	EPR	1.08	1.10	1.13	1.17	1.24	1.33	
	KIAS	213	213	213	213	213	213	
	FF/ENG	5660	5570	5390	5310	5300	5360	
180	EPR	1.07	1.09	1.11	1.15	1.21	1.29	1.42
	KIAS	205	205	205	205	205	205	205
	FF/ENG	5210	5110	4930	4830	4810	4850	4940
160	EPR	1.06	1.07	1.10	1.13	1.18	1.25	1.35
	KIAS	197	197	197	197	197	197	197
	FF/ENG	4740	4670	4490	4370	4340	4350	4370
140	EPR	1.05	1.06	1.08	1.11	1.15	1.21	1.29
	KIAS	188	188	188	188	188	188	188
	FF/ENG	4290	4220	4060	3930	3880	3880	3900
120	EPR	1.04	1.05	1.07	1.09	1.12	1.17	1.24
	KIAS	179	179	179	179	179	179	179
	FF/ENG	3850	3770	3630	3500	3460	3450	3460

This table includes 5% additional fuel for holding in a racetrack pattern.



**Performance Inflight**  
**Gear Down, Engine Inop**

**Chapter PI**  
**Section 26**

**GEAR DOWN**

**ENGINE INOP**

**MAX CONTINUOUS THRUST**

**Driftdown Speed/Level Off Altitude**

**100 ft/min residual rate of climb**

**Includes APU fuel burn**

WEIGHT (1000 LB)		OPTIMUM DRIFTDOWN SPEED (KIAS)	LEVEL OFF ALTITUDE (FT)		
START DRIFTDOWN	LEVEL OFF		ISA + 10°C & BELOW	ISA + 15°C	ISA + 20°C
220	208	218	6000	2700	
200	190	210	10000	7800	5300
180	172	203	13700	11900	9700
160	153	195	17300	15800	14100
140	134	187	20600	19700	18300

**Long Range Cruise Altitude Capability**

**100 ft/min residual rate of climb**

WEIGHT (1000 LB)	PRESSURE ALTITUDE (FT)		
	ISA + 10°C & BELOW	ISA + 15°C	ISA + 20°C
200	6200		
190	9100	5700	
180	11800	9000	5800
170	14100	12000	8800
160	16000	14400	12200
150	17900	16400	14600
140	19800	18500	16800
130	21400	20500	19200
120	22900	22000	21000

**With engine bleed for packs off, increase altitude capability by 100 ft.**

**With engine anti-ice on, decrease altitude capability by 5100 ft.**

**With engine and wing anti-ice on, decrease altitude capability by 8900 ft.**

**GEAR DOWN**

**ENGINE INOP**

**MAX CONTINUOUS THRUST**

**Long Range Cruise Control**

WEIGHT (1000 LB)		PRESSURE ALTITUDE (1000 FT)							
		6	8	10	12	14	16	18	20
200	EPR	1.36	1.40						
	MACH	.368	.378						
	KIAS	220	218						
	FF/ENG	10640	10565						
180	EPR	1.32	1.35	1.39	1.43				
	MACH	.353	.364	.374	.385				
	KIAS	211	210	208	206				
	FF/ENG	9622	9548	9443	9407				
160	EPR	1.27	1.30	1.33	1.37	1.41	1.47		
	MACH	.334	.346	.358	.369	.382	.397		
	KIAS	200	199	199	197	197	197		
	FF/ENG	8498	8488	8450	8352	8379	8418		
140	EPR	1.23	1.25	1.28	1.31	1.35	1.40	1.45	1.52
	MACH	.315	.327	.339	.352	.366	.380	.396	.412
	KIAS	188	188	188	188	188	188	188	188
	FF/ENG	7481	7445	7432	7423	7423	7375	7448	7644
120	EPR	1.19	1.21	1.24	1.26	1.30	1.33	1.37	1.42
	MACH	.300	.311	.323	.335	.349	.362	.377	.392
	KIAS	179	179	179	179	179	179	179	179
	FF/ENG	6612	6590	6559	6520	6536	6457	6465	6502

**GEAR DOWN**  
**ENGINE INOP**

**MAX CONTINUOUS THRUST**

**Long Range Cruise Diversion Fuel and Time  
 Ground to Air Miles Conversion**

AIR DISTANCE (NM)					GROUND DISTANCE (NM)	AIR DISTANCE (NM)				
HEADWIND COMPONENT (KTS)						TAILWIND COMPONENT (KTS)				
100	80	60	40	20	20	40	60	80	100	
169	149	132	119	109	100	93	88	83	78	75
343	302	267	240	219	200	187	175	165	156	148
518	455	402	361	328	300	281	263	247	234	222
694	610	538	483	438	400	374	350	329	311	295
872	765	674	604	548	500	467	438	411	388	368
1051	921	811	726	658	600	560	524	492	464	440
1232	1078	948	848	769	700	653	611	574	541	513
1415	1237	1087	971	879	800	746	698	655	617	585

**Reference Fuel and Time Required at Check Point**

AIR DIST (NM)	PRESSURE ALTITUDE (1000 FT)							
	6		10		14		18	
	FUEL (1000 LB)	TIME (HR:MIN)	FUEL (1000 LB)	TIME (HR:MIN)	FUEL (1000 LB)	TIME (HR:MIN)	FUEL (1000 LB)	TIME (HR:MIN)
100	4.3	0:29	3.8	0:28	3.4	0:27	3.2	0:26
200	8.8	0:54	8.0	0:53	7.6	0:51	7.3	0:47
300	13.2	1:20	12.2	1:17	11.6	1:14	11.3	1:09
400	17.6	1:46	16.3	1:42	15.6	1:38	15.2	1:31
500	21.9	2:12	20.4	2:07	19.5	2:02	19.1	1:53
600	26.1	2:39	24.4	2:32	23.3	2:26	22.9	2:16
700	30.4	3:06	28.4	2:58	27.1	2:50	26.6	2:39
800	34.5	3:33	32.3	3:23	30.9	3:15	30.3	3:02

**Fuel Required Adjustment (1000 LB)**

REFERENCE FUEL REQUIRED (1000 LB)	WEIGHT AT CHECK POINT (1000 LB)				
	160	180	200	220	240
5	-0.5	-0.2	0.0	0.4	1.0
10	-1.1	-0.5	0.0	0.8	2.0
15	-1.6	-0.8	0.0	1.3	3.0
20	-2.2	-1.1	0.0	1.7	3.9
25	-2.8	-1.4	0.0	2.2	4.8
30	-3.3	-1.6	0.0	2.7	5.7
35	-3.9	-1.9	0.0	3.1	6.5

Includes APU fuel burn.

**GEAR DOWN**

**ENGINE INOP**

**MAX CONTINUOUS THRUST**

**Holding  
Flaps Up**

WEIGHT (1000 LB)		PRESSURE ALTITUDE (FT)			
		1500	5000	10000	15000
220	EPR	1.31	1.37		
	KIAS	220	220		
	FF/ENG	11760	11740		
200	EPR	1.27	1.33		
	KIAS	213	213		
	FF/ENG	10730	10720		
180	EPR	1.24	1.29	1.38	
	KIAS	205	205	205	
	FF/ENG	9780	9740	9730	
160	EPR	1.21	1.25	1.33	1.44
	KIAS	197	197	197	197
	FF/ENG	8850	8780	8750	8760
140	EPR	1.18	1.22	1.28	1.37
	KIAS	188	188	188	188
	FF/ENG	7910	7870	7800	7730
120	EPR	1.15	1.18	1.24	1.31
	KIAS	179	179	179	179
	FF/ENG	6970	6950	6890	6790

This table includes 5% additional fuel for holding in a racetrack pattern.

---

## **Introduction**

This chapter contains information to supplement performance data from the Flight Management Computer (FMC). In addition, sufficient inflight data is provided to complete a flight with the FMC inoperative. In the event of conflict between data presented in this chapter and that contained in the approved Airplane Flight Manual, the Flight Manual shall always take precedence.

---

## **General**

### **Takeoff Speeds**

The speeds presented in the Takeoff Speeds table can be used for all performance conditions except where adjustments must be made to V1 for clearway, stopway, antiskid inoperative, brakes deactivated, improved climb, contaminated runway situations, brake energy limits, or obstacle clearance with unbalanced V1. These speeds may be used for weights less than or equal to the performance limited weight.

Normal takeoff speeds, V1, VR, and V2, with anti-skid on and all brakes operative, are read from the table by entering with takeoff flap setting, brake release weight and appropriate column. The appropriate column is obtained by entering the Column Reference chart with the airport pressure altitude and the actual temperature or assumed temperature for reduced thrust takeoffs. Slope and wind adjustments to V1 are obtained by entering the V1 Adjustment chart. Adjusted V1 must not exceed VR. These takeoff speeds are not valid when the brake release weight is based on clearway, stopway, improved climb or is limited by tire speed or brake energy.

### **V1(MCG)**

Regulations prohibit scheduling takeoff with a V1 less than minimum V1 for control on the ground, V1(MCG). Therefore compare the adjusted V1 to the V1(MCG). To find V1(MCG) enter the V1(MCG) table with the airport pressure altitude and actual OAT. If the adjusted V1 is less than V1(MCG), set V1 equal to V1(MCG). If VR is less than V1(MCG), set VR equal to V1(MCG), and determine a new V2 by adding the difference between the normal VR and V1(MCG) to the normal V2. No takeoff weight adjustment is necessary provided that the actual field length exceeds the minimum field length.

---

## Clearway and Stopway V1 Adjustments

Takeoff speed adjustments are to be applied to V1 speed when using takeoff weights based on the use of clearway and stopway.

Adjust V1 speed by the amount shown in the table. The adjusted V1 speed must not exceed VR.

Maximum allowable clearway limits are provided for guidance when more precise data is not available.

### Stab Trim

To find takeoff stabilizer trim setting, enter Stab Trim Setting table with anticipated brake release weight and center of gravity (C.G. % MAC) and read required stabilizer trim units.

### VREF

The Reference Speed table contains flaps 30, 25 and 20 landing speeds for a given weight.

### Flap Maneuver Speeds

This table provides the flap speed schedule for minimum maneuver speeds. Using VREF as the basis for the schedule makes it variable as a function of weight and will provide adequate maneuver margin above stall at all weights.

During flap retraction/extension, movement of the flap to the next position should be initiated when within 20 knots of the recommended speed for that position.

### Slush/Standing Water Takeoff

Experience has shown that aircraft performance may deteriorate significantly on runways covered with snow, slush, standing water or ice. Therefore, reductions in runway/obstacle limited takeoff weight and revised takeoff speeds are necessary. The tables are intended for guidance in accordance with advisory material and assumes an engine failure at the critical point during the takeoff.

The entire runway is assumed to be completely covered by a contaminant of uniform thickness and density. Therefore this information is conservative when operating under typical colder weather conditions where patches of slush exist and some degree of sanding is common. Takeoffs in slush depths greater than 13mm (0.5 inches) are not recommended because of possible airplane damage as a result of slush

impingement on the airplane structure. The use of assumed temperature for reduced thrust is not allowed on contaminated runways. Interpolation for slush/standing water depths between the values shown is permitted.

Takeoff weight is determined as follows:

1. Determine the field/obstacle limit weight for the takeoff flap setting.
2. Enter the Weight Adjustment table with the field/obstacle limit weight to obtain the weight reduction for the slush/standing water depth and airport pressure altitude.
3. Adjust field length available for temperature by amount shown on table.
4. Enter the V1(MCG) Limit Weight table with the adjusted field length and pressure altitude to obtain the slush/standing water limit weight with respect to minimum field length required for V1(MCG) speed.

The maximum allowable takeoff weight in slush/standing water is the lesser of the limit weights found in steps 2 and 4.

Takeoff speed determination:

1. Determine takeoff speeds V1, VR and V2 for actual brake release weight using the Takeoff Speeds table in this section.
2. If V1(MCG) limited, set  $V1=V1(MCG)$ . If not limited by V1(MCG) considerations, enter the V1 Adjustment table with actual brake release weight to determine the V1 reduction to apply to V1 speed. If the adjusted V1 is less than V1(MCG), set  $V1=V1(MCG)$ . The adjusted V1 must not exceed VR.

## Slippery Runway Takeoff

Airplane braking action is reported as good, medium or poor, depending on existing runway conditions. If braking action is reported as good, conditions should not be expected to be as good as on clean, dry runways. The value “good” is comparative and is intended to mean that airplanes should not experience braking or directional control difficulties when stopping. Good reported braking action denotes wet runway conditions or runways covered by compact snow. Similarly, poor braking action denotes runways covered with wet ice. Performance is based on reversers operating and a 15 ft. screen height at the end of the runway. The tables provided are used in the same manner as the Slush/Standing Water tables.

## Anti-Skid Inoperative

When operating with anti-skid inoperative, the field limit weight and V1 must be reduced to account for the effect on accelerate-stop performance. A simplified method which conservatively accounts for the effects of anti-

**757 Flight Crew Operations Manual**

skid inoperative on a dry runway is to reduce the normal runway/obstacle limited weight by 28000 lb and the V1 associated with the reduced weight by the amount shown in the table below.

ANTI-SKID INOPERATIVE ADJUSTMENT				
FIELD LENGTH (FT)	V1 ADJUSTMENT (KTS)*			
	FLAPS 1	FLAPS 5	FLAPS 15	FLAPS 20
6000	-46	-41	-39	-36
8000	-37	-33	-31	-29
10000	-30	-27	-26	-25
12000	-25	-23		
14000	-20	-19		

\*Reduce V1 adjustment by 1 knot per 10000 lb below 240000 lb.

If the resulting V1 is less than minimum V1, takeoff is permitted with V1 set equal to V1(MCG) provided the accelerate-stop distance corrected for wind and slope exceeds approximately 7150 ft.

Detailed analysis for the specific case from the Airplane Flight Manual may yield a less restrictive penalty.

**Brakes Deactivated**

When operating with brakes deactivated, the field and brake energy limit weights and the V1 and VMBE must be reduced to allow for reduced braking capability. A simplified method which conservatively accounts for the reduced braking capability of one brake deactivated is to reduce the normal runway/obstacle limited weight by 4000 lb and the V1 associated with the reduced weight by the amount shown in the table below.

ONE BRAKE DEACTIVATED SPEED ADJUSTMENT	
FIELD LENGTH (FT)	V1 ADJUSTMENT (KTS)
6000	-3
8000	-2
10000	-2
12000	-2
14000	-1

If the resulting V1 is less than minimum V1, takeoff is permitted with V1 set equal to V1(MCG) provided the accelerate-stop distance exceeds approximately 3750 ft for one brake deactivated.

**Takeoff EPR**

To find Max Takeoff EPR based on normal engine bleed for air conditioning packs on, enter Takeoff EPR table with airport pressure altitude and airport OAT and read EPR. EPR adjustments are shown for packs off and wing anti-ice on.



---

## Max Climb EPR

This table shows Max Climb EPR for a 250/290/.78 climb speed schedule, normal engine bleed for packs on and anti-ice off. Enter the table with airport pressure altitude and TAT and read EPR. EPR adjustments are shown for packs off and anti-ice operation.

## Go-around EPR

To find Max Go-around EPR based on normal engine bleed for packs on, enter the Go-Around EPR table with airport pressure altitude and reported OAT or TAT and read EPR. EPR adjustments are shown for packs off and wing anti-ice on.

## Flight with Unreliable Airspeed / Turbulent Air Penetration

Pitch attitude and average EPR information is provided for use in all phases of flight in the event of unreliable airspeed/Mach indications resulting from blocking or freezing of the pitot system. Loss of radome or turbulent air may also cause unreliable airspeed/Mach indications. The cruise table in this section may also be used for turbulent air penetration.

Pitch attitude is shown in bold type for emphasis since altitude and/or vertical speed indications may also be unreliable.

---

## All Engines

### Long Range Cruise Maximum Operating Altitude

These tables provide the maximum operating altitude in the same manner as the FMC. Maximum altitudes are shown for a given cruise weight and maneuver capability. Note that these tables consider both thrust and buffet limits, providing the more limiting of the two. Any data that is thrust limited is denoted by an asterisk and represents only a thrust limited condition in level flight with maximum cruise thrust at 0 ft/min residual rate of climb or maximum climb thrust at 100 ft/min residual rate of climb. Flying above these altitudes with sustained banks in excess of approximately 12° may cause the airplane to lose speed and/or altitude.

Note that optimum altitudes shown in the tables result in buffet related maneuver margins of 1.5g (48° bank) or more. The altitudes shown in the table are limited to the maximum certified altitude of 42000 ft.

### Long Range Cruise Control

These tables provide target EPR, Long Range Cruise Mach number, IAS and standard day fuel flow per engine for the airplane weight and pressure altitude. As indicated by the shaded area, at optimum altitude .80M approximates the Long Range Cruise Mach schedule.

---

## APU Operation During Flight

For APU operation during flight, increase fuel flow according to the table in the Engine Inoperative text section.

## Long Range Cruise Enroute Fuel and Time

Long Range Cruise Enroute Fuel and Time tables are provided to determine remaining time and fuel required to destination. The data is based on Long Range Cruise and .78/290/250 descent. Tables are presented for low altitudes and high altitudes.

To determine remaining fuel and time required, first enter the Ground to Air Miles Conversion table to convert ground distance and enroute wind to an equivalent still air distance for use with the Reference Fuel and Time tables. Next, enter the Reference Fuel and Time table with air distance from the Ground to Air Miles Conversion table and the desired altitude and read Reference Fuel and Time Required. Lastly, enter the Fuel Required Adjustment table with the Reference Fuel and the actual weight at checkpoint to obtain fuel required to destination.

## Long Range Cruise Wind-Altitude Trade

Wind is a factor which may justify operations considerably below optimum altitude. For example, a favorable wind component may have an effect on ground speed which more than compensates for the loss in air range.

Using this table, it is possible to determine the break-even wind (advantage necessary or disadvantage that can be tolerated) to maintain the same range at another altitude and long range cruise speed. The table makes no allowance for climb or descent time, fuel or distance, and is based on comparing ground fuel mileage.

## Descent

Distance and time for descent are shown for a .78/290/250 descent speed schedule. Enter the table with top of descent pressure altitude and read distance in nautical miles and time in minutes. Data is based on flight idle thrust descent in zero wind. Allowances are included for a straight-in approach with gear down and landing flaps at the outer marker.

## Holding

Target EPR, indicated airspeed and fuel flow per engine information is tabulated for holding with flaps up based on the FMC optimum holding speed schedule. This is the higher of the maximum endurance speed and the maneuvering speed. Small variations in airspeed will not appreciably affect the overall endurance time. Enter the table with weight and pressure altitude to read EPR, IAS and fuel flow per engine.

---

---

## Advisory Information

### Normal Configuration Landing Distance

Tables are provided as advisory information for normal configuration landing distance on dry runways and slippery runways with good, medium, and poor reported braking action. These values are actual landing distances and do not include the 1.67 regulatory factor. Therefore, they cannot be used to determine the dispatch required landing field length.

To use these tables, determine the reference landing distance for the selected braking configuration. Then adjust the reference distance for landing weight, altitude, wind, slope, temperature, approach speed, and the number of operative thrust reversers to obtain the actual landing distance.

When landing on slippery runways or runways contaminated with ice, snow, slush, or standing water, the reported braking action must be considered. If the surface is affected by water, snow, or ice and the braking action is reported as "good", conditions should not be expected to be as good as on clean, dry runways. The value "good" is comparative and is intended to mean that airplanes should not experience braking or directional control difficulties when landing. The performance level used to calculate the "good" data is consistent with wet runway testing done on early Boeing jets. The performance level used to calculate "poor" data reflects runways covered with wet ice.

Use of the autobrake system commands the airplane to a constant deceleration rate. In some conditions, such as a runway with "poor" braking action, the airplane may not be able to achieve these deceleration rates. In these cases, runway slope and inoperative reversers influence the stopping distance. Since it cannot be determined quickly when this becomes a factor, it is conservative to add the effects of slope and inoperative reversers when using the autobrake system.

### Non-normal Configuration Landing Distance

Advisory information is provided to support non-normal configurations that affect the landing performance of the airplane. Landing distances and adjustments are provided for dry runways and runways with good, medium, and poor reported braking action.

Enter the table with the applicable non-normal configuration and read the normal approach speed. The reference landing distance is a reference distance from 50 ft above the threshold to stop based on a reference landing weight and speed at sea level, zero wind, and zero slope. Subsequent columns provide adjustments for off-reference landing weight,

altitude, wind, slope, and speed conditions. Each adjustment is independently added to the reference landing distance. Landing distance includes the effects of max manual braking and reverse thrust.

## Recommended Brake Cooling Schedule

Advisory information is provided to assist in avoiding the problems associated with hot brakes. For normal operation, most landings are at weights below the AFM quick turnaround limit weight.

Use of the recommended cooling schedule will help avoid brake overheat and fuse plug problems that could result from repeated landings at short time intervals or a rejected takeoff.

Enter the Recommended Brake Cooling Schedule table with the airplane weight and brakes on speed, adjusted for wind, at the appropriate temperature and altitude condition. Instructions for applying wind adjustments are included below the table. Linear interpolation may be used to obtain intermediate values. The resulting number is the reference brake energy per brake in millions of foot-pounds, and represents the amount of energy absorbed by each brake during a rejected takeoff

To determine the energy per brake absorbed during landing, enter the appropriate Adjusted Brake Energy Per Brake table (No Reverse Thrust or Two Engine Reverse) with the reference brake energy per brake and the type of braking used during landing (Max Manual, Max Auto, or Autobrake). The resulting number is the adjusted brake energy per brake and represents the energy absorbed in each brake during the landing.

The recommended cooling time is found in the final table by entering with the adjusted brake energy per brake or brake temperature monitor system (BTMS) indication on EICAS. Times are provided for ground cooling and inflight gear down cooling.

If brake temperature monitor indication on EICAS is available, the hottest brake indication 10 to 15 minutes after the airplane has come to a complete stop, or inflight with gear retracted, may be used to determine the recommended cooling schedule by entering at the bottom of the chart. The brake temperature light illuminates when the hottest brake is registering 5 on the EICAS indication and extinguishes as the hottest brake cools with an EICAS indication of 4.

---

---

## Engine Inoperative

### Initial Max Continuous EPR

The Initial Max Continuous EPR setting for use following an engine failure is shown. The table shows a range of Cruise Mach numbers to provide a target EPR setting at the start of driftdown. Also shown is the maximum TAT at which the limit EPR can be set. Once driftdown is established, the Max Continuous EPR table should be used to determine EPR for the given conditions.

### Max Continuous EPR

Power setting is based on one engine operating with one A/C pack operating and all anti-ice bleeds off. Enter the table with pressure altitude and IAS or Mach to read EPR.

It is desirable to maintain engine thrust level within the limits of the Max Cruise thrust rating. However, where thrust level in excess of Max Cruise rating is required, such as for meeting terrain clearance, ATC altitude assignments, or to attain maximum range capability, it is permissible to use the thrust needed up to the Max Continuous thrust rating. The Max Continuous thrust rating is intended primarily for emergency use at the discretion of the pilot and is the maximum thrust that may be used continuously.

### Driftdown Speed/Level Off Altitude

The table shows optimum driftdown speed as a function of cruise weight at start of driftdown. Also shown are the approximate weight and pressure altitude at which the airplane will level off considering 100 ft/min residual rate of climb.

The level off altitude is dependent on air temperature (ISA deviation).

### Driftdown/LRC Range Capability

This table shows the range capability from the start of driftdown. Driftdown is continued to level off altitude. As weight decreases due to fuel burn, the airplane is accelerated to Long Range Cruise speed. Cruise is continued at level off altitude and Long Range Cruise speed.

To determine fuel required, enter the Ground to Air Miles Conversion table with the desired ground distance and adjust for anticipated winds to obtain air distance to destination. Then enter the Driftdown/Cruise Fuel and Time table with air distance and weight at start of driftdown to determine fuel

and time required. If altitudes other than the level off altitude are used, fuel and time required may be obtained by using the Engine Inoperative Long Range Cruise Enroute Fuel and Time table.

### Long Range Cruise Altitude Capability

The table shows the maximum altitude that can be maintained at a given weight and air temperature (ISA deviation), based on Long Range Cruise speed, Max Continuous thrust, and 100 ft/min residual rate of climb.

### Long Range Cruise Control

The table provides target EPR, engine inoperative Long Range Cruise Mach number, IAS and fuel flow for the airplane weight and pressure altitude. The fuel flow values in this table reflect single engine fuel burn.

### APU Operation During Flight

For APU operation during flight, increase fuel flow according to the following table. These increments include the APU fuel flow and the effect of increased drag from the APU door.

PRESSURE ALTITUDE (1000 FT)	APU FUEL FLOW (LB/HR)
39	160
35	160
31	190
25	210
20	230
15	240
10	280
5	300

### Long Range Cruise Diversion Fuel and Time

Tables are provided for crews to determine the fuel and time required to proceed to an alternate airfield with one engine inoperative. The data is based on single engine Long Range Cruise speed and .78/290/250 descent. Enter with Air Distance as determined from the Ground to Air Miles Conversion table and read Fuel and Time required at the cruise pressure altitude. Adjust the fuel obtained for deviation from the reference weight at checkpoint as required by entering the Fuel Required Adjustment table with the fuel required for the reference weight and the actual weight at checkpoint.

### Holding

Single engine holding data is provided in the same format as the all engine holding data and is based on the same assumptions.

---

---

## Alternate Thrust Setting

### Introduction

This section contains performance data for airplane operation using %N1 as an alternate method to set thrust. The data includes engine bleed effects for normal air conditioning operation; i.e., two packs on at normal flow, all engines operating, and one pack on at normal flow with one engine inoperative.

### Takeoff Performance

A simplified method which conservatively accounts for the effects of using %N1 as an alternate thrust setting is to reduce the normal limit weights. The Takeoff Performance table provides takeoff field, tire speed, climb and obstacle limit weight adjustments. To determine limit weight for operations with alternate thrust setting, enter the table with takeoff flap setting and apply the weight reduction to the normal full rate limit weight. The most limiting of the takeoff weights must be used.

Improved climb performance procedure and reduced thrust operation using assumed temperature method is not permitted. Derate 1 and Derate 2 operation is not permitted. Use of autothrottle is not permitted.

### Takeoff Speeds

Takeoff speeds for the reduced weights should be adjusted by the amount shown in the Takeoff Speeds table. The adjusted V1 should not exceed the adjusted VR.

NOTE: The FMC does not incorporate alternate thrust setting performance in its takeoff speeds calculations.

### Enroute Performance

The Enroute Performance table provides the weight adjustment that must be applied to the enroute climb limit weight when using %N1 as an alternate thrust setting.

### Landing Performance

The Landing Performance table provides the weight adjustment that must be applied to the Approach/Landing Climb limit weight. Enter the table with the appropriate flap setting and apply the weight reduction to the normal full rate limit weight. The alternate thrust setting Approach/Landing Climb limit must be compared to the Landing Field Length limit and the most limiting of the two be used as the landing limit weight.

---

## Takeoff %N1/Go-around %N1

Takeoff and Go-around power setting are presented for normal air conditioning bleed. Max Takeoff or Go-around %N1 may be read directly from the tables for the desired pressure altitude and airport OAT.

Thrust protection is not provided in the alternate thrust setting and maximum rated thrust is reached at a thrust lever position less than full forward. As a result, thrust overboost can occur at full forward thrust lever positions.

### Max Climb %N1

This table shows Max Climb %N1 for a 250/290/.78 climb speed schedule, normal engine bleed for packs on and anti-ice off. Enter the table with airport pressure altitude and TAT and read %N1. %N1 adjustments are shown for packs off and anti-ice operation.

### Max Cruise %N1

Maximum Cruise %N1 is presented for .80M, which approximates Long Range Cruise speed. The table is based on normal air conditioning bleed, 2 bleeds/2 packs on. Enter the table with pressure altitude and TAT to read Max Cruise %N1. Appropriate bleed adjustments are shown.

---

## Alternate Thrust Setting, Engine Inoperative

### Initial Max Continuous %N1

The Initial Max Continuous %N1 setting, with normal engine bleed for packs on and anti-ice off, following engine failure in cruise is shown for .80M and a range of altitudes and TAT.

### Max Continuous %N1

Max Continuous %N1 which can be set during engine out cruise conditions is presented. Enter the appropriate table with pressure altitude, TAT, and KIAS to obtain Maximum Continuous %N1. Intermediate airspeeds may be interpolated. Appropriate bleed adjustments are shown.

---

## Gear Down

This section contains performance for airplane operation with the landing gear extended for all phases of flight. The data is based on engine bleeds for normal air conditioning.

NOTE: The Flight Management Computer System (FMCS) does not contain special provisions for operation with landing gear extended. As a result, the FMCS will generate inaccurate enroute speed schedules, display



---

non-conservative predictions of fuel burn, estimated time of arrival (ETA), maximum altitude, and compute overly shallow descent path. To obtain accurate ETA predictions, gear down cruise speed and altitude should be entered on the CLB and CRZ pages. Gear down cruise speed should also be entered on the DES page and a STEP SIZE of zero should be entered on the PERF INIT or CRZ page. Use of the VNAV during descent under these circumstances is not recommended.

Tables for gear down performance in this section are identical in format and used in the same manner as tables for the gear up configuration previously described.

Intentionally  
Blank

**Airplane General, Emergency  
Equipment, Doors, Windows**

**Chapter 1**

**Table of Contents**

**Section 0**

**Dimensions . . . . . 1.10**  
Principal Dimensions . . . . . 1.10.1  
Turning Radius . . . . . 1.10.3

**Instrument Panels. . . . . 1.20**  
Flight Deck Panels . . . . . 1.20.1  
Left Overhead Panel . . . . . 1.20.2  
Right Overhead Panel . . . . . 1.20.3

**Instrument Panels. . . . . 1.21**  
Left Forward Panel . . . . . 1.21.1  
Right Forward Panel . . . . . 1.21.2  
Glareshield Panel . . . . . 1.21.3  
Forward Aisle Stand . . . . . 1.21.3  
Center Forward Panel . . . . . 1.21.4

**Instrument Panels. . . . . 1.22**  
Control Stand . . . . . 1.22.1  
Aft Aisle Stand. . . . . 1.22.2  
Right Sidewall, Accessory Panel . . . . . 1.22.3  
Left, Right Sidewall, and Observer Panels . . . . . 1.22.4

**Controls and Indicators . . . . . 1.30**  
Push-Button Switches . . . . . 1.30.1  
    Alternate Action Switches . . . . . 1.30.1  
    Momentary Action Switches . . . . . 1.30.2  
Passenger Cabin Signs . . . . . 1.30.2  
    Passenger Sign Selectors . . . . . 1.30.2  
Lighting . . . . . 1.30.3  
    Flight Deck Lighting . . . . . 1.30.3  
    Exterior Lighting . . . . . 1.30.7

---

Emergency Lighting Controls	1.30.9
Doors and Windows	1.30.10
Exterior Door Annunciator Lights	1.30.10
Exterior Door Locations	1.30.10
Passenger Entry Doors	1.30.11
Door Mode Select Panel	1.30.12
Emergency Doors	1.30.13
Overwing Emergency Exit Doors	1.30.14
Flight Deck Door	1.30.15
Flight Deck Door Switch	1.30.18
Flight Deck Number Two Window	1.30.19
Oxygen Systems	1.30.20
Oxygen Indications	1.30.20
Passenger Oxygen Switch	1.30.20
Oxygen Mask Panel	1.30.21
Oxygen Mask and Regulator	1.30.23
<b>Systems Description</b>	<b>1.40</b>
Introduction	1.40.1
Lighting Systems	1.40.1
Exterior Lighting	1.40.1
Exterior Lighting Locations	1.40.2
Flight Deck Lighting	1.40.3
Indicator Lights	1.40.3
Passenger Cabin Signs	1.40.3
Emergency Lighting	1.40.4
Oxygen Systems	1.40.4
Flight Crew Oxygen System	1.40.5
Passenger Oxygen System	1.40.5
Portable Oxygen Bottles	1.40.5
Doors and Windows	1.40.5
Flight Deck Door	1.40.6
Flight Deck Number Two Windows	1.40.7
Passenger Entry Doors	1.40.8

---

Passenger Entry Door and Slide Operation . . . . .	1.40.9
Escape Slide Deployed . . . . .	1.40.10
Emergency Doors . . . . .	1.40.10
Overwing Emergency Exit Doors. . . . .	1.40.11
Overwing Door . . . . .	1.40.12
Evacuation Slides . . . . .	1.40.13
Cargo Doors . . . . .	1.40.14
Flight Deck Seats . . . . .	1.40.15
Pilot Seat Adjustment . . . . .	1.40.16
<b>Emergency Equipment. . . . .</b>	<b>1.45</b>
Introduction . . . . .	1.45.1
Emergency Equipment. . . . .	1.45.1
Fire Extinguishers . . . . .	1.45.1
Miscellaneous Emergency Equipment . . . . .	1.45.2
Emergency Equipment Symbols . . . . .	1.45.3
Emergency Equipment Locations . . . . .	1.45.4
<b>EICAS Messages. . . . .</b>	<b>1.50</b>
Airplane General, Emergency Equipment, Doors, Windows EICAS Messages . . . . .	1.50.1
Access Doors . . . . .	1.50.1
Cargo Doors . . . . .	1.50.1
Entry Doors. . . . .	1.50.2
Emergency Exit Doors . . . . .	1.50.2
Overwing Emergency Exit . . . . .	1.50.3
Emergency Lights. . . . .	1.50.3
Oxygen System. . . . .	1.50.3

Intentionally  
Blank

# DO NOT USE FOR FLIGHT

## 757 Flight Crew Operations Manual

### Airplane General, Emergency Equipment, Doors, Windows Dimensions

### Chapter 1

### Section 10

#### Principal Dimensions

[Option- Pratt & Whitney powered 757-200 with 6 Entry doors and 2 Emergency doors.]

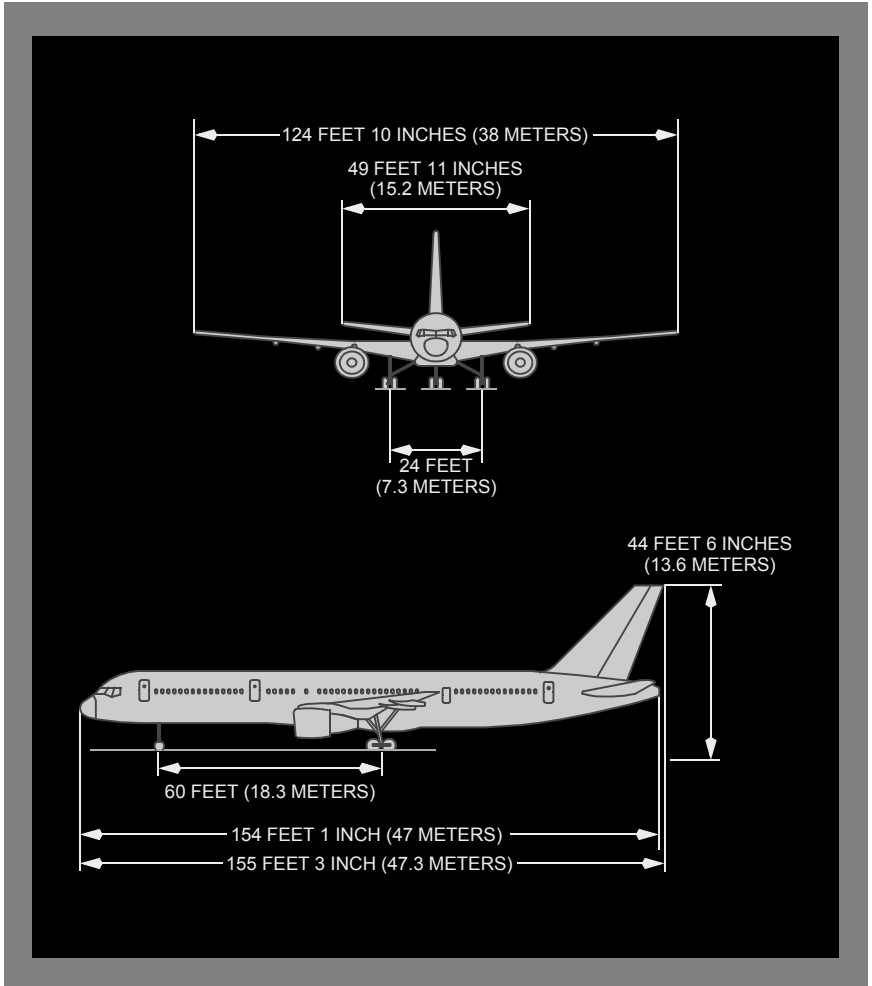

[Option- Rolls Royce powered 757-200 with 6 Entry doors and 4 Overwing doors.]

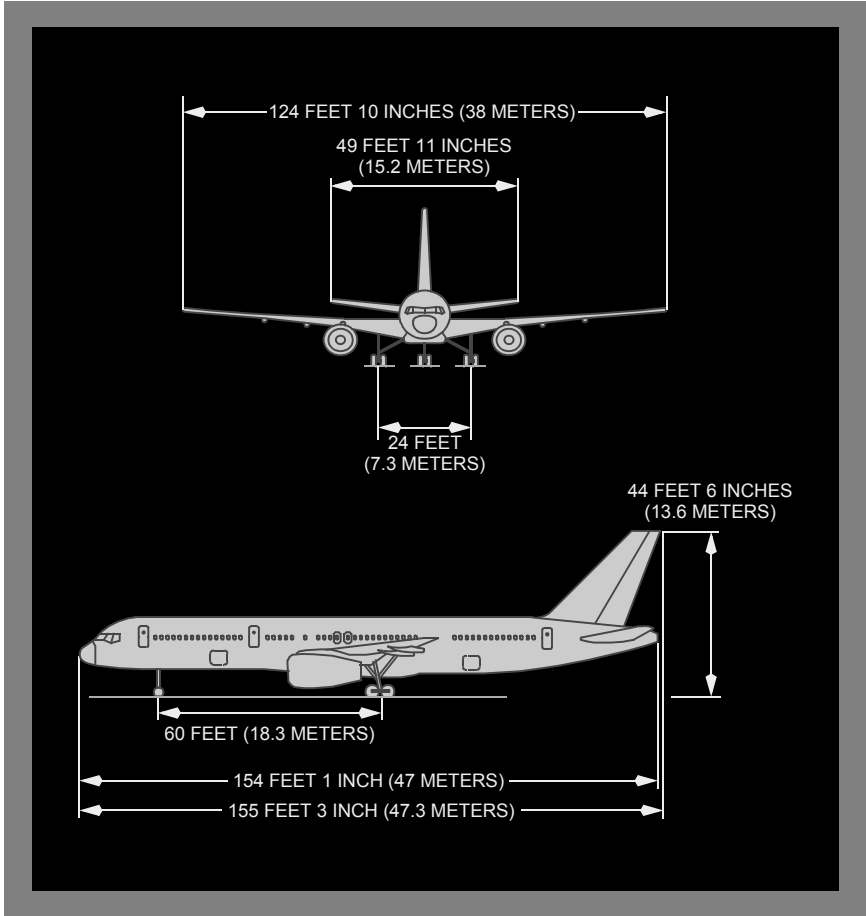



## Turning Radius

THE WING TIP SWINGS THE LARGEST ARC WHILE TURNING AND DETERMINES THE MINIMUM OBSTRUCTION CLEARANCE PATH. ALL OTHER PORTIONS OF THE AIRPLANE STRUCTURE REMAIN WITHIN THIS ARC.

**NOSE RADIUS**  
87 FEET (26.5 METERS)

**TAIL RADIUS**  
95 FEET (29.0 METERS)

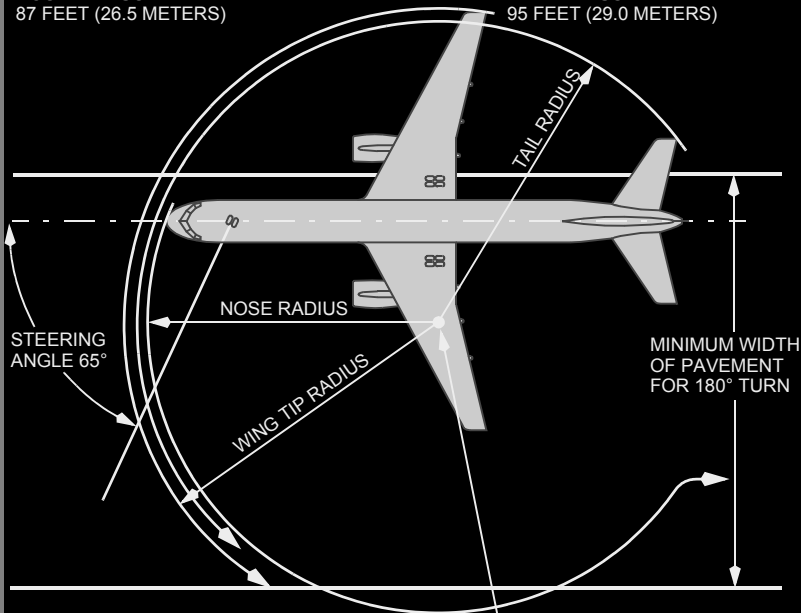

STEERING  
ANGLE 65°

NOSE RADIUS

TAIL RADIUS

WING TIP RADIUS

MINIMUM WIDTH  
OF PAVEMENT  
FOR 180° TURN

**WING TIP RADIUS**  
98 FEET (29.9 METERS)

CENTER OF TURN FOR MINIMUM  
TURNING RADIUS. (SLOW  
CONTINUOUS TURNING WITH  
MINIMUM THRUST ON ALL ENGINES.  
NO DIFFERENTIAL BRAKING.)

**NOTE:** MINIMUM WIDTH OF PAVEMENT FOR 180° TURN:  
120 FEET (36.6 METERS)

**CAUTION:** DO NOT ATTEMPT TO MAKE A TURN AWAY FROM AN OBSTACLE WITHIN  
15 FEET (4.6 METERS) OF THE WING TIP OR WITHIN 26 FEET (7.9  
METERS) OF THE NOSE.

Intentionally  
Blank

**Flight Deck Panels**

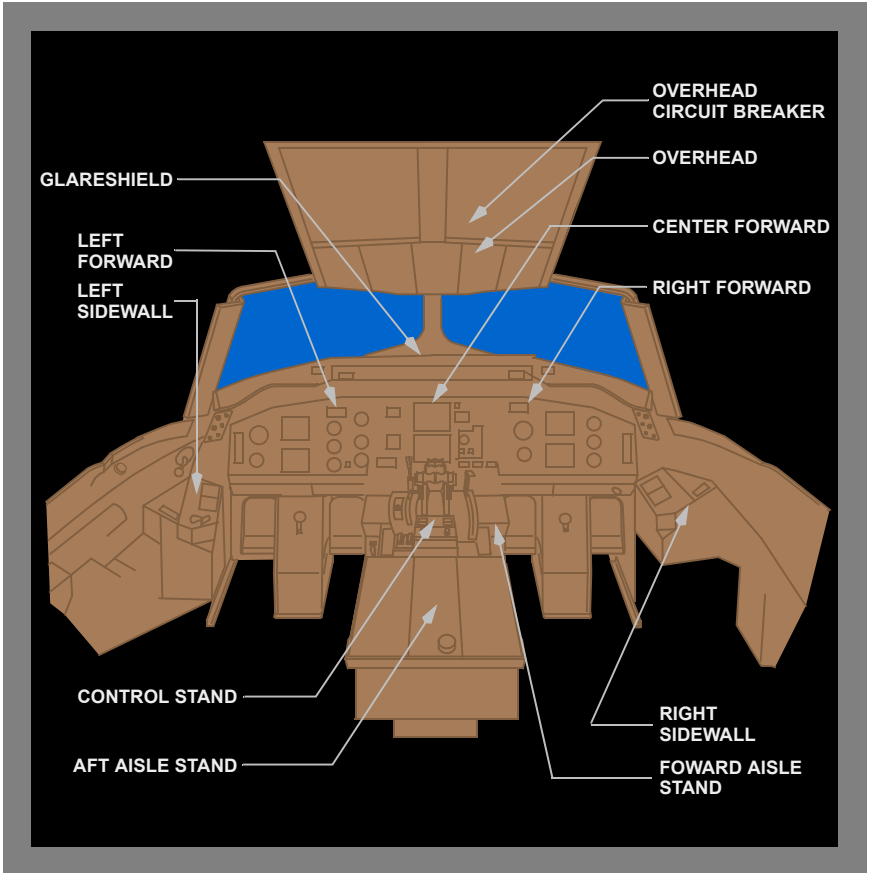

On the following pages, circled numbers refer to chapters where information on the item may be found.

The panels, controls, and indicators shown in this chapter are representative of installed units and may not exactly match the latest configuration. Refer to the appropriate chapter system descriptions for current information.

Left Overhead Panel

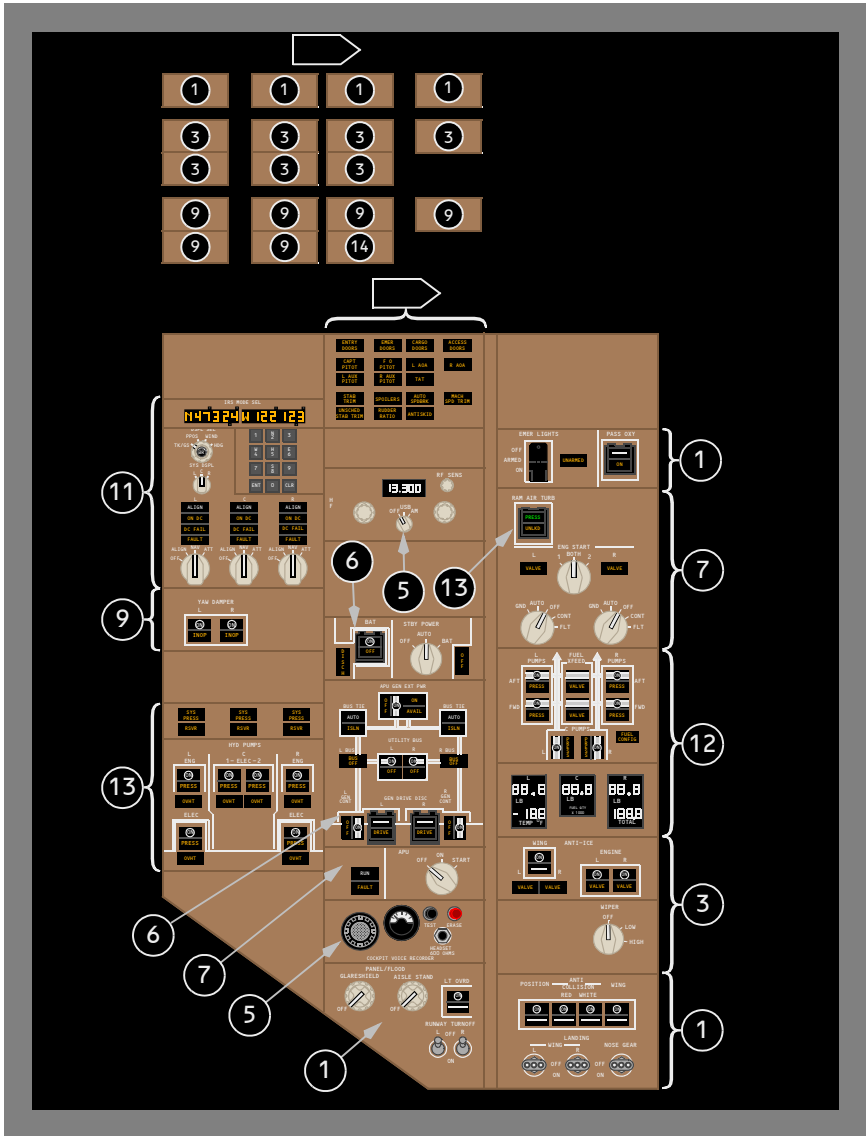

## Right Overhead Panel

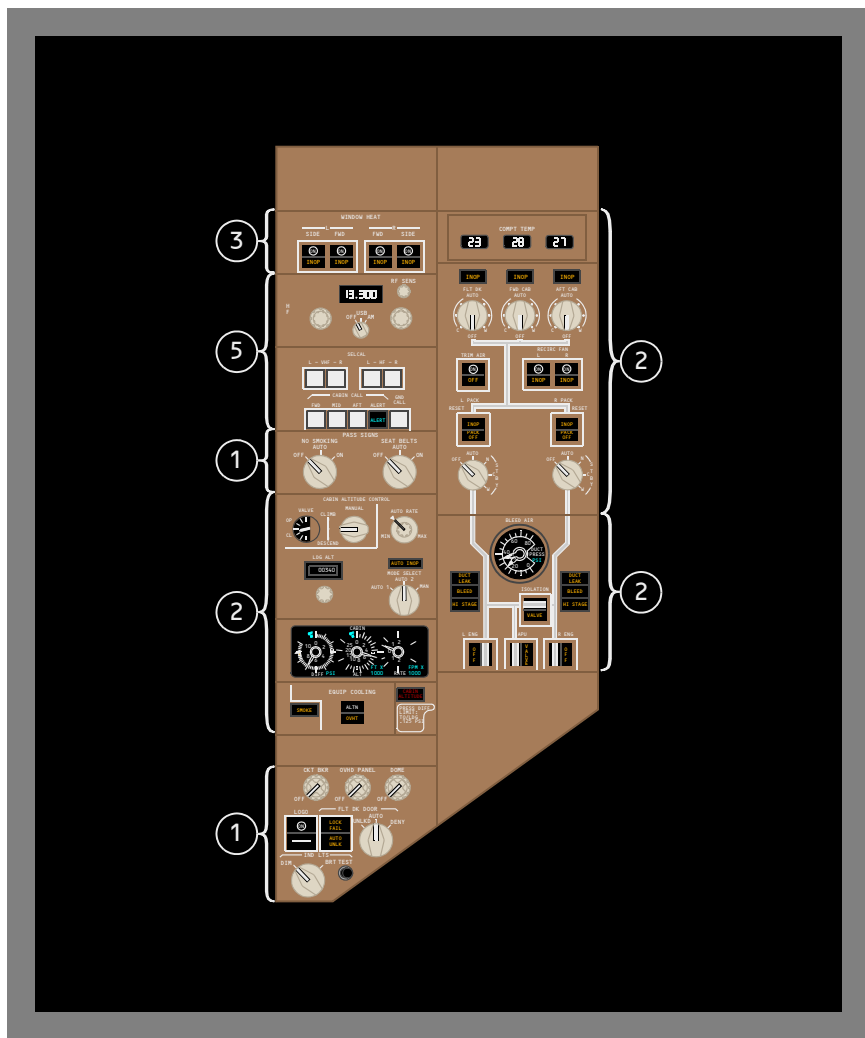

Intentionally  
Blank

# DO NOT USE FOR FLIGHT

757 Flight Crew Operations Manual

## Airplane General, Emergency Equipment, Doors, Windows Instrument Panels

## Chapter 1

## Section 21

### Left Forward Panel

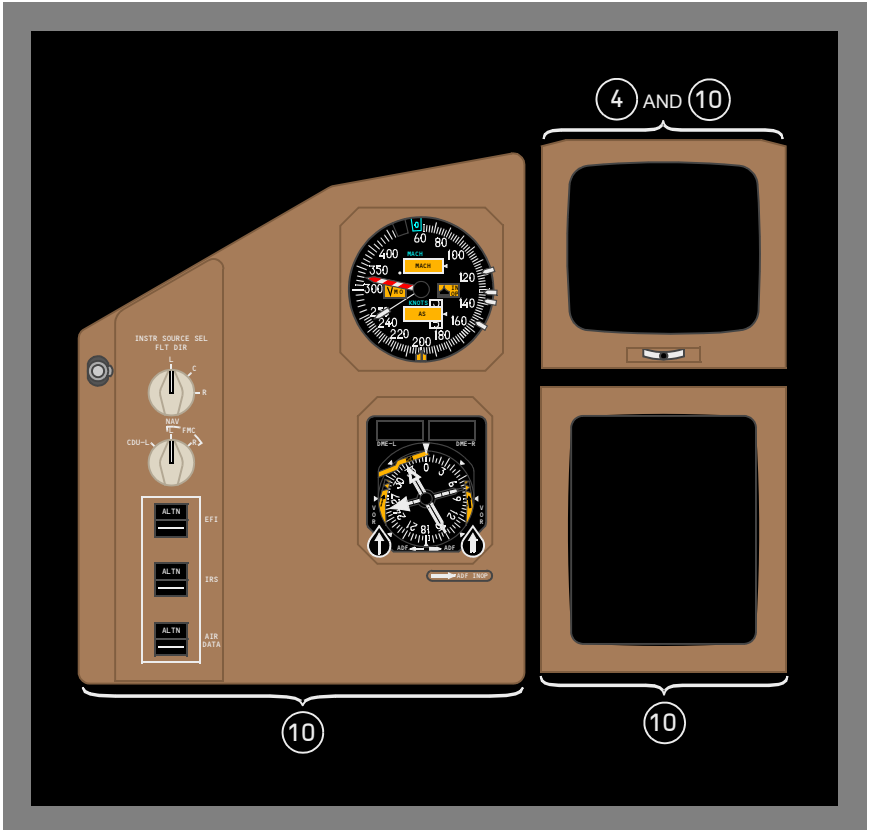

## Right Forward Panel

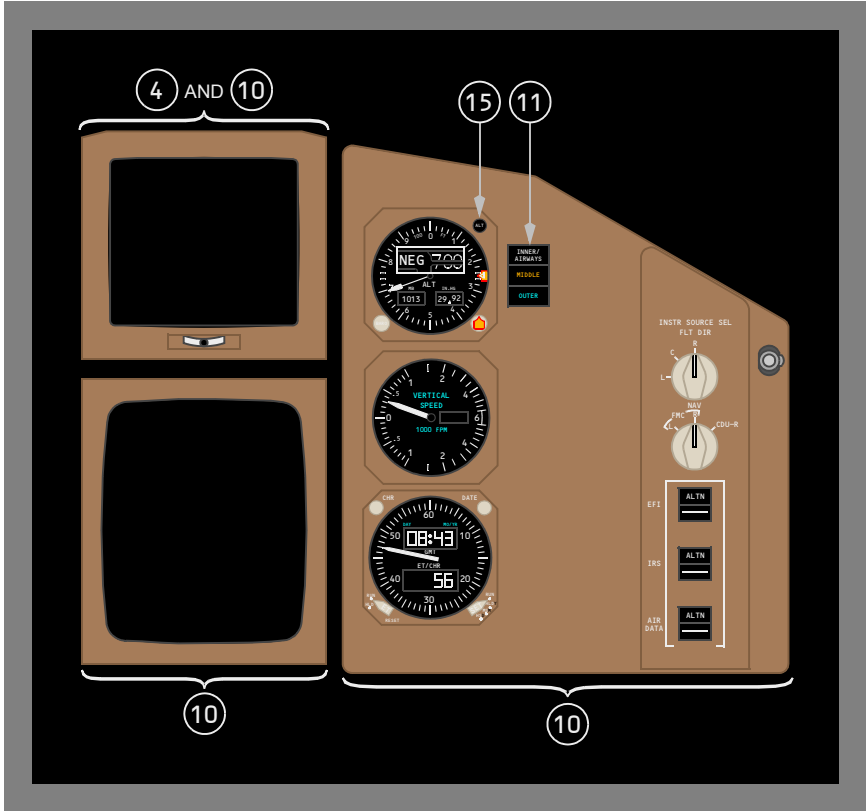



## Glareshield Panel

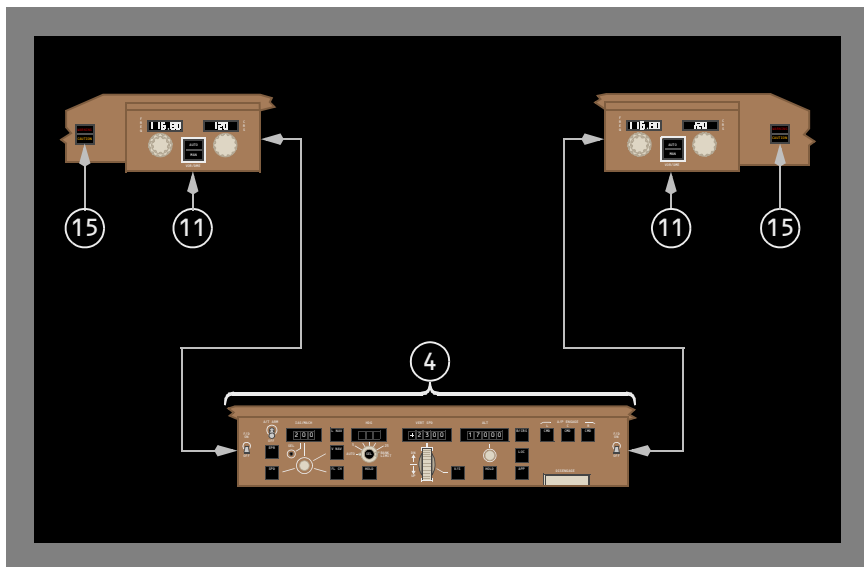

## Forward Aisle Stand

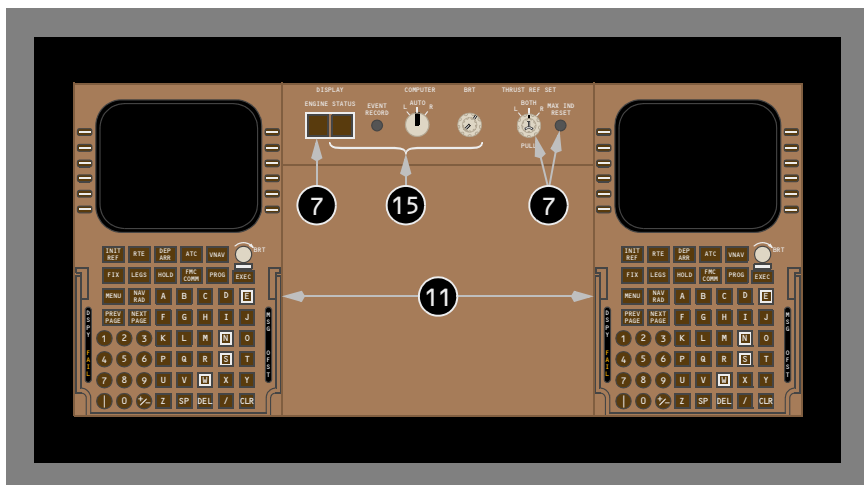

## Center Forward Panel

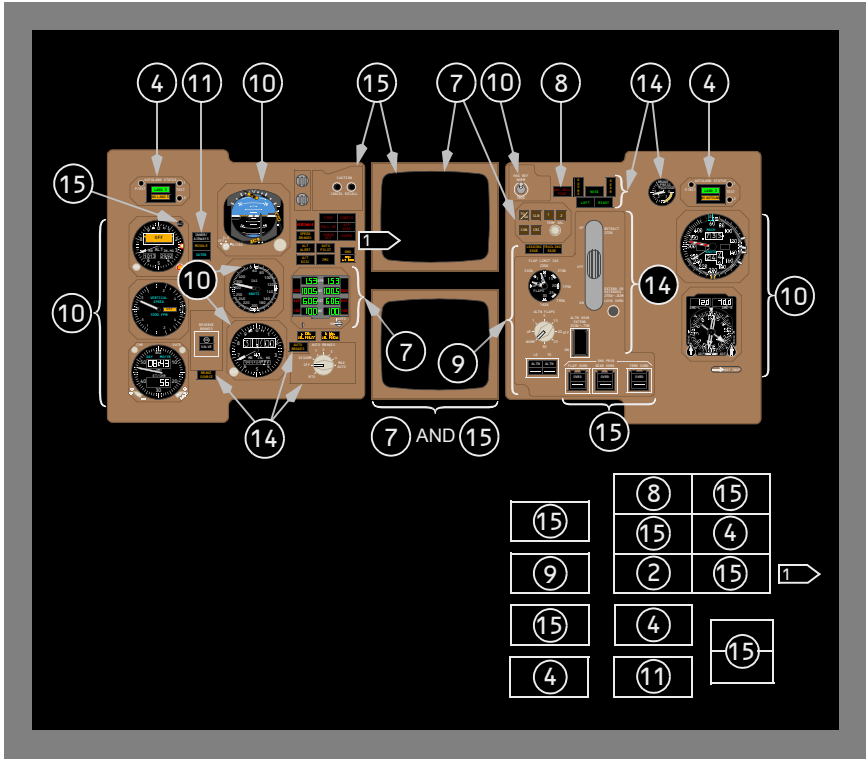

# DO NOT USE FOR FLIGHT

757 Flight Crew Operations Manual

## Airplane General, Emergency Equipment, Doors, Windows Instrument Panels

## Chapter 1

## Section 22

### Control Stand

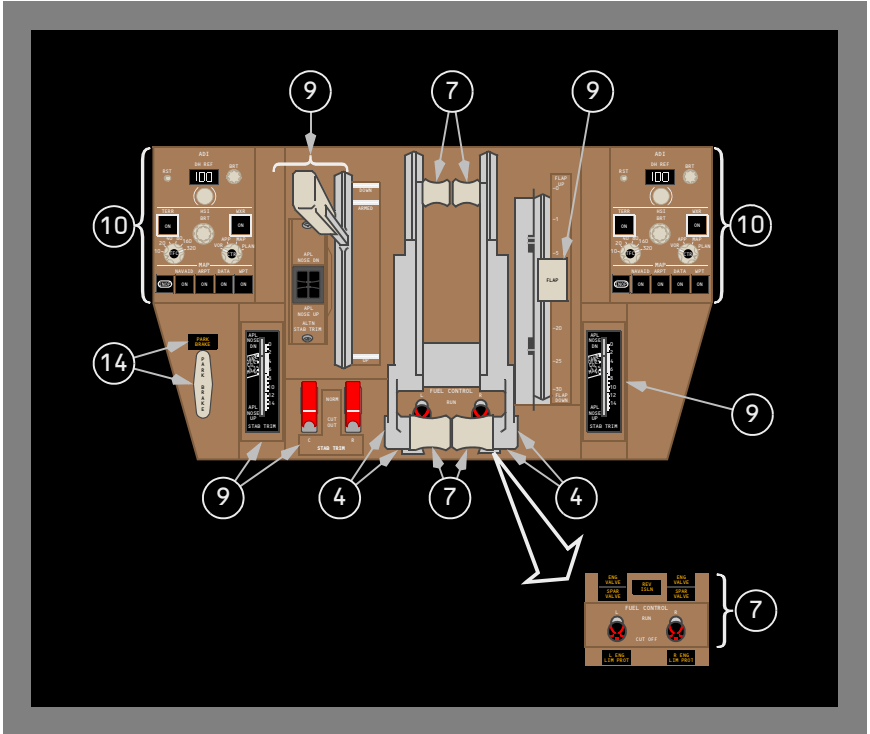

Aft Aisle Stand

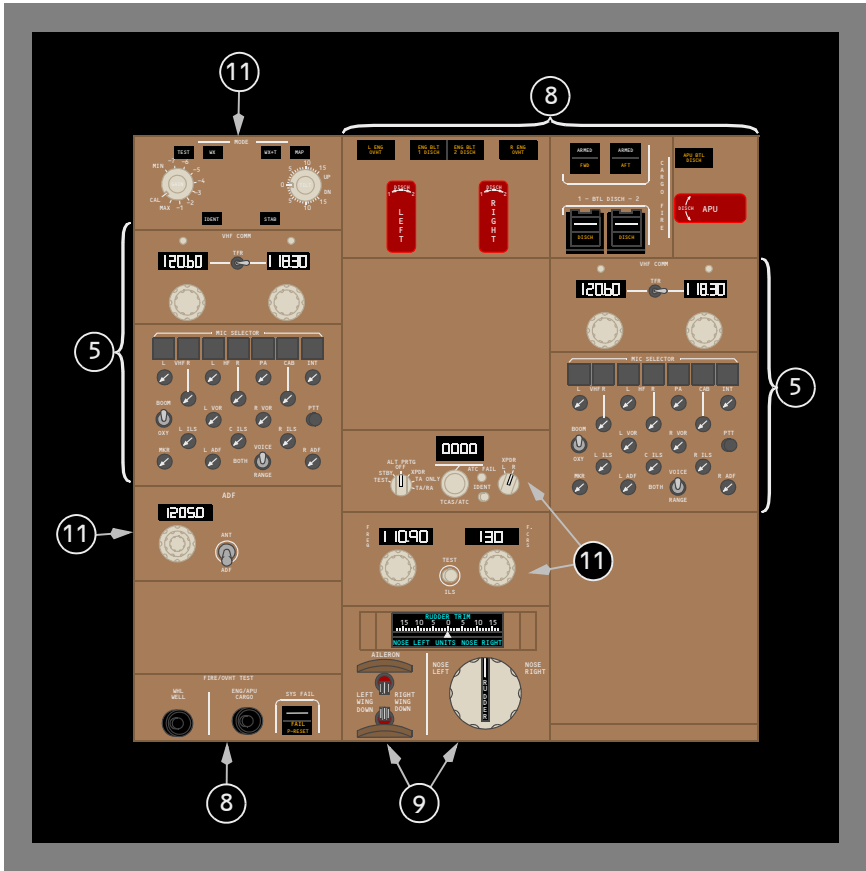

**Right Sidewall, Accessory Panel**

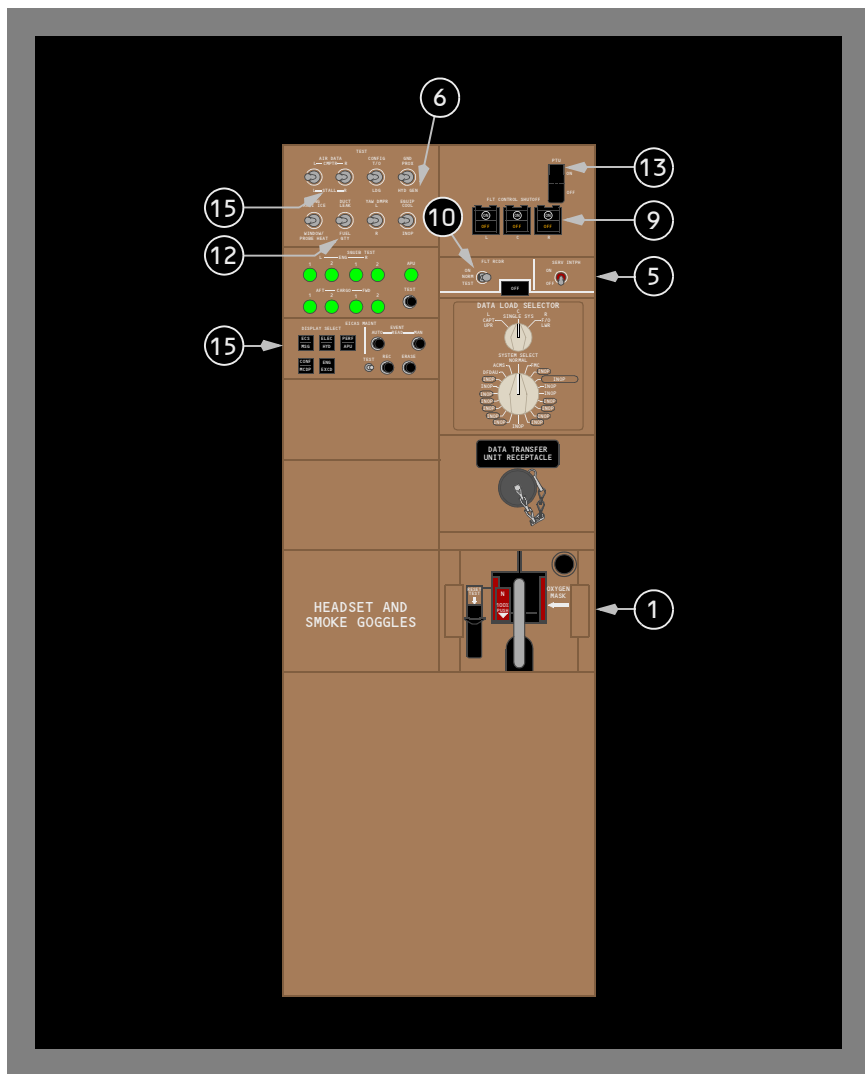

## Left, Right Sidewall, and Observer Panels

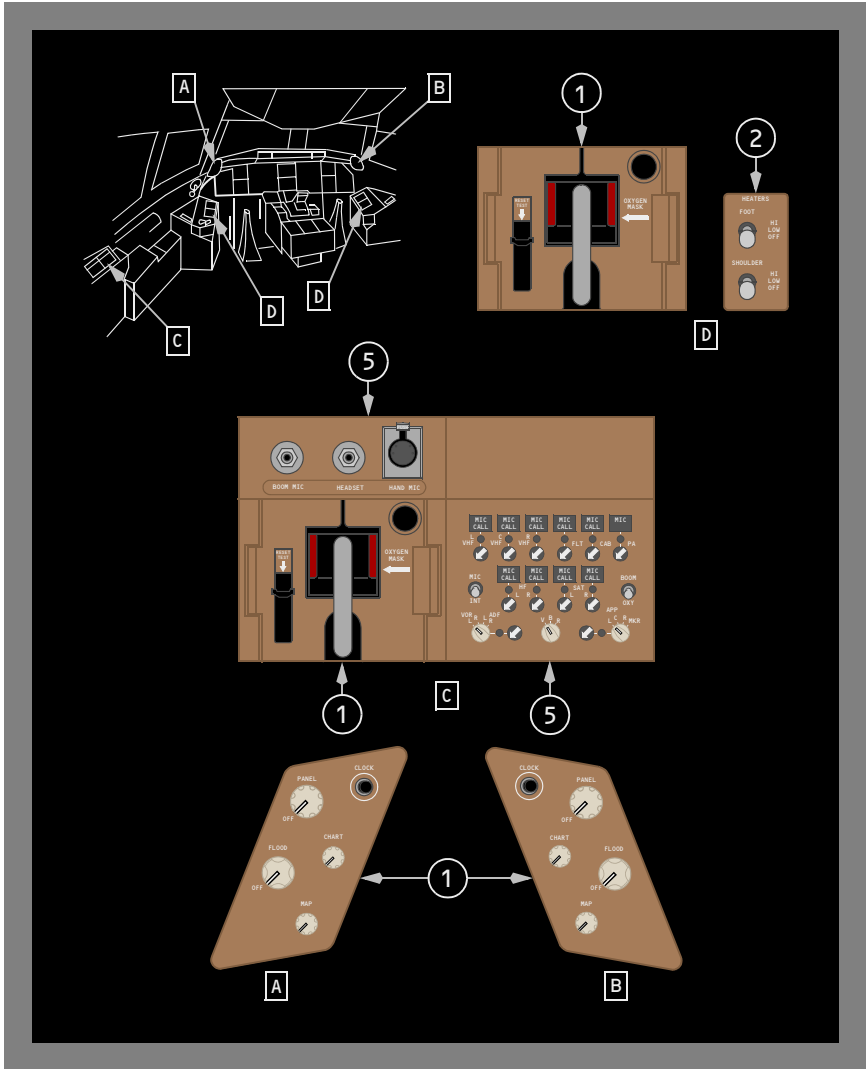

## Push-Button Switches

The airplane has two types of push-button switches: alternate action and momentary action. The switch may contain an indicator light that illuminates to indicate system status or faults. A line indicates there is no label for that portion of the switch.

**Note:** Maintenance personnel should be contacted for all relamping operations. Unintentional system operation can result from improper relamping.

## Alternate Action Switches

Alternate action switches have two positions: on and off.

When pushed in and flush with the panel, the switch is on. When the switch is on, a mechanical shutter on one half of the switch opens to show an illuminated legend, such as "ON", "AUTO" or a flow bar.

When pushed out and extended, the switch is off. When the switch is off, the mechanical shutter closes so the legend is not shown.

Additionally, the other half of many switches has a light to indicate system state, such as "PRESS", "FAIL", "INOP" or "OFF".

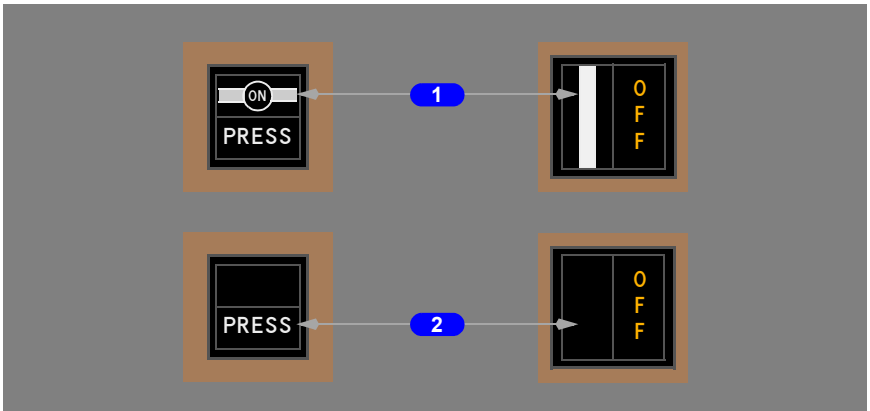

### 1 Switch is ON

A mechanical shutter opens and a word, symbol or combination is visible.

### 2 Switch is OFF

A mechanical shutter closes and the ON indication is not visible.

## Momentary Action Switches

Momentary action switches are spring loaded to the extended position. They are used to activate or deactivate systems or to reset system logic. The switch display indicates system status.



### 1 Push to Reset

Push – the switch resets the master lights and aural alerts.

### 2 System Operation

Push – activates or deactivates the system.

## Passenger Cabin Signs

### Passenger Sign Selectors



### 1 NO SMOKING Selector

OFF – the no smoking signs are extinguished.

AUTO – the no smoking signs illuminate or extinguish with reference to landing gear position (refer to Lighting System Description section).

ON – the no smoking signs illuminate.

**Note:** Anytime passenger oxygen is deployed, no smoking and fasten seat belts signs illuminate and return to seat signs extinguish, regardless of selector position.



## 2 SEAT BELTS Selector

OFF – the fasten seat belts and return to seats signs are extinguished.

AUTO – the fasten seat belts and return to seats signs illuminate or extinguish with reference to landing gear or flap position (refer to Lighting System Description section).

ON – the fasten seat belts and return to seats signs illuminate.

**Note:** Anytime passenger oxygen is deployed, no smoking and fasten seat belts signs illuminate and return to seat signs extinguish, regardless of selector position.

## Lighting

### Flight Deck Lighting

#### Light Override Switch

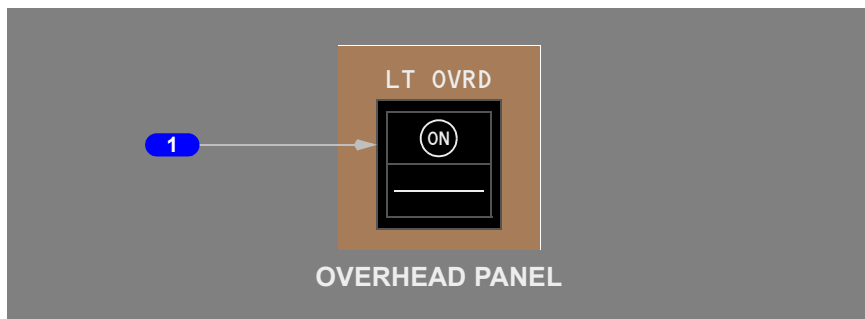

#### 1 Light Override (LT OVRD) Switch

ON – overrides normal controls and illuminates the following lights at maximum brightness:

- forward panel flood lights
- illuminated indicator lights
- glareshield flood lights
- aisle stand flood lights
- dome lights

## Circuit Breaker/Overhead Panel and Dome Lights Control

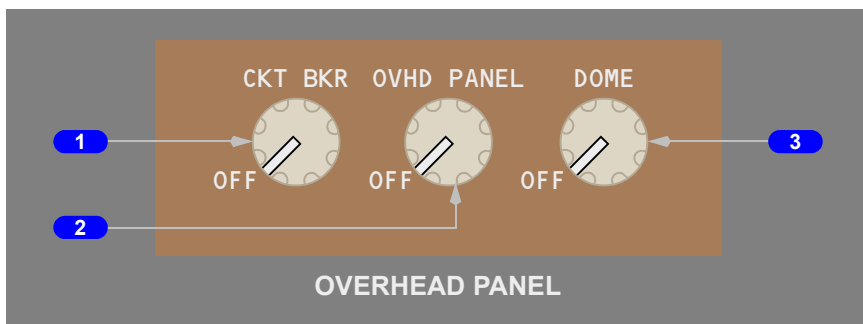

### 1 Circuit Breaker (CKT BKR) Panel Light Control

Rotate – controls circuit breaker panel light brightness.

### 2 Overhead (OVHD) Panel Lights Control

Rotate – controls overhead panel light brightness.

### 3 DOME Lights Control

Rotate – controls dome light brightness

## Glareshield Panel/Flood Light Controls

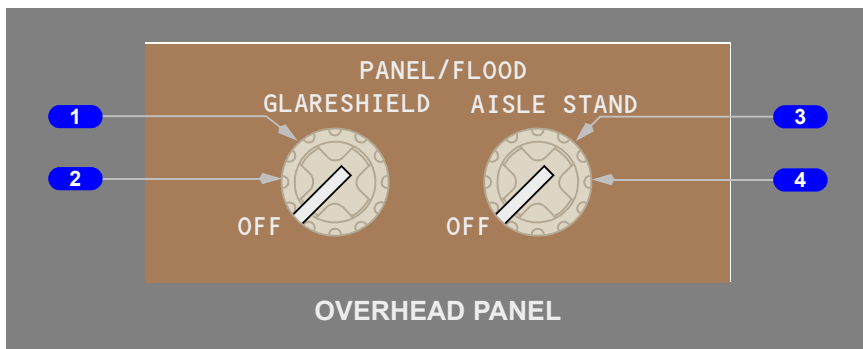

### 1 GLARESHIELD FLOOD Light Control (inner)

Rotate – controls glareshield flood light brightness.

### 2 GLARESHIELD PANEL Light Control (outer)

Rotate – controls glareshield panel light brightness.

### 3 AISLE STAND FLOOD Light Control (inner)

Rotate – controls the aisle stand flood light brightness.

#### **4 AISLE STAND PANEL Light Control (outer)**

Rotate – controls the aisle stand instrument panel light brightness.

#### **Indicator Lights Switch**

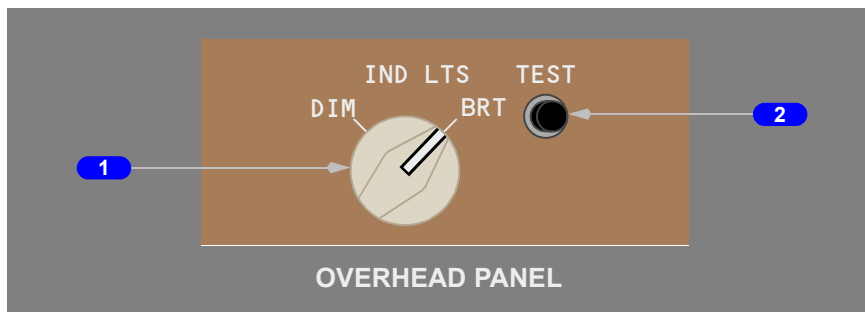

#### **1 Indicator Lights (IND LTS) Switch**

BRT –sets all illuminated annunciator lights to full brightness.

DIM – sets all illuminated annunciator lights to low brightness.

#### **2 Indicator Lights (IND LTS) TEST Switch**

Push –

- Initiates an indicator lights test
- Lights illuminate at the intensity selected by the Indicator Lights selector
- Tests the ADI and HSI displays if the airplane is on the ground
- Illuminates the IRS data display characters.

## Pilots Lighting Control Panel

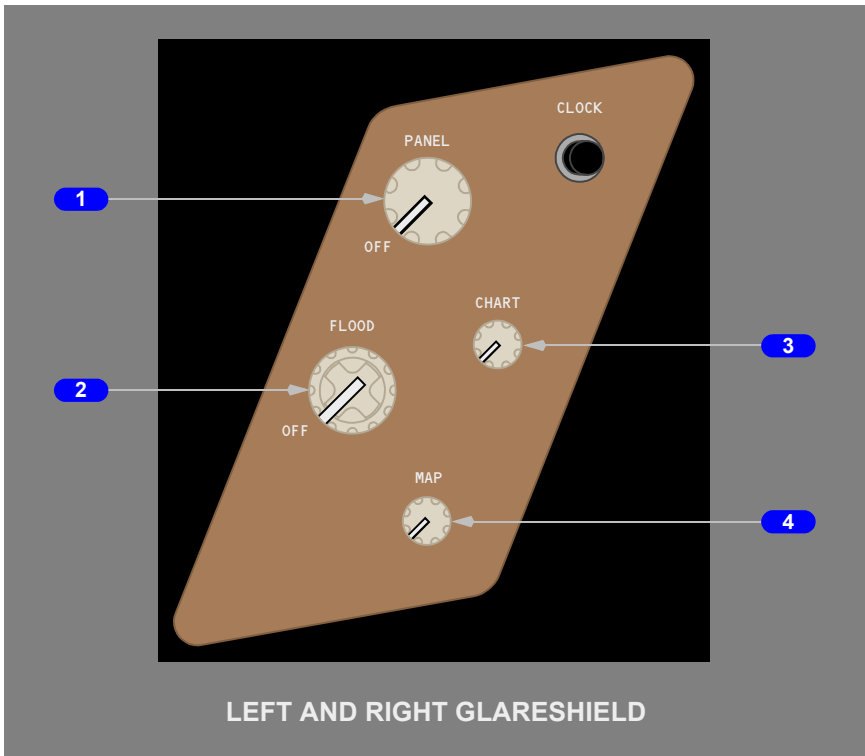

### 1 PANEL Light Control

Rotate –

- left controls left forward and center forward instrument panel lights and standby magnetic compass brightness
- right controls right forward panel lights brightness

### 2 FLOOD Light Control

Rotate –

- left controls left forward and center forward instrument panel flood lights brightness
- right controls right forward instrument panel flood lights brightness

### 3 CHART Light Control

Pull – on.

Push – off.

Rotate – adjusts chart light brightness.

#### 4 MAP Light Control

Pull – on.

Push – off.

Rotate – adjusts map light brightness.

## Exterior Lighting

### Lighting Control Panel

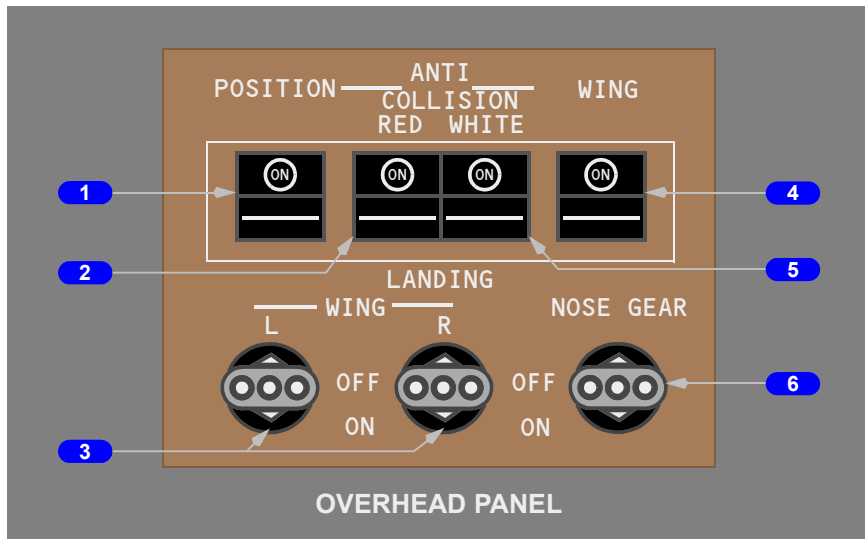

#### 1 POSITION Light Switch

ON – the red, green, and white position lights illuminate.

OFF (ON not visible) – the red, green, and white position lights extinguish.

#### 2 ANTI-COLLISION RED Light Switch

ON – the red anti-collision strobe lights on the top and bottom of the fuselage operate.

OFF (ON not visible) – the red anti-collision strobe lights on the top and bottom of the fuselage do not operate.

#### 3 WING LANDING Light Switches

ON – the landing light illuminates.

OFF – the landing light extinguishes.

**4 WING Light Switch**

ON – the wing leading edge illumination lights illuminate.

OFF – the wing leading edge illumination lights extinguish.

**5 ANTI-COLLISION WHITE Light Switch**

ON – the white anti-collision strobe lights on tips of each wing operate.

OFF (ON not visible) – the white anti-collision strobe lights on tips of each wing do not operate.

**6 NOSE GEAR LANDING Light Switch**

ON – the landing lights illuminate.

OFF – the landing lights extinguish.

**Note:** The nose gear landing lights do not illuminate when the nose landing gear is not down and locked.

**Runway Turnoff Light Switches**

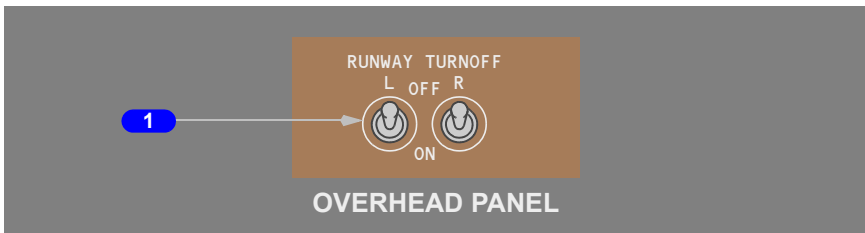

**1 RUNWAY TURNOFF Light Switches**

ON – the runway turnoff light illuminates.

OFF – the runway turnoff light extinguishes.

**LOGO Lights**

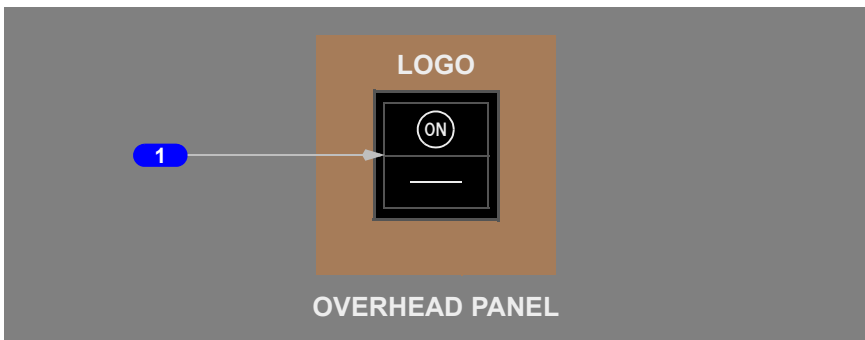

**1 LOGO Light Switch**

ON – the stabilizer mounted logo lights illuminate the vertical tail surface.

## Emergency Lighting Controls

### Flight Deck Emergency Lights Switch

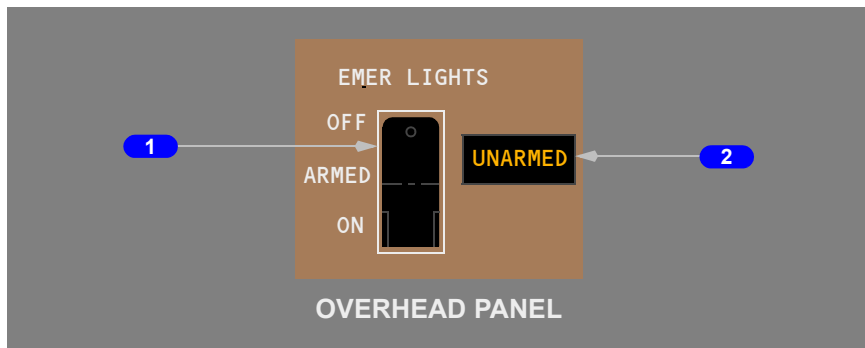

**1 Emergency (EMER) LIGHTS Switch**

OFF – prevents emergency lights system operation if airplane electrical power fails or is turned off.

ARMED – all emergency lights illuminate if airplane electrical power fails or is turned off.

ON – all emergency lights illuminate.

**2 Emergency Lights UNARMED Light**

Illuminated (amber) – the emergency lighting system has been manually activated or the emergency lights switch is OFF.

### Passenger Cabin Emergency Lights Switch

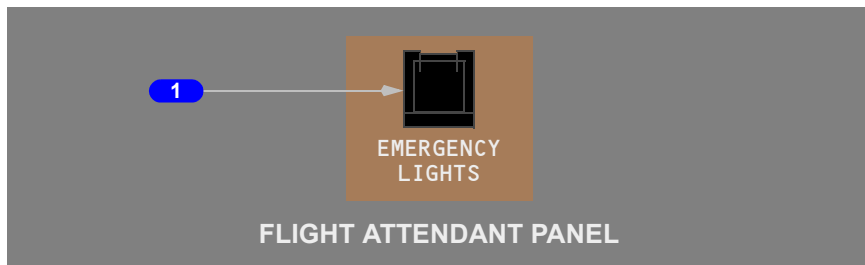

## 1 Passenger Cabin EMERGENCY LIGHTS Switch

Push –

- Illuminated (red):
  - all passenger cabin and exterior emergency lights illuminate
  - bypasses the flight deck emergency lights switch
- Extinguished: all passenger cabin and exterior emergency lights extinguish.

## Doors and Windows

### Exterior Door Annunciator Lights

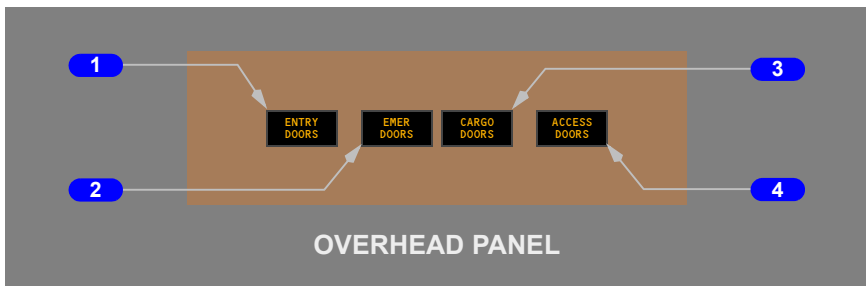

#### 1 ENTRY DOORS Light

Illuminated (amber) – an entry door is not closed, and latched and locked.

#### 2 Emergency (EMER) DOORS Light

Illuminated (amber) – an emergency exit door is not closed and latched and locked.

Illuminated (amber) – a forward or aft emergency door, or wing slide door is not closed and latched and locked.

#### 3 CARGO DOORS Light

Illuminated (amber) – the forward or aft cargo compartment door is not closed, and latched and locked.

#### 4 ACCESS DOORS Light

Illuminated (amber) – the forward equipment bay or the electrical equipment compartment door is not closed and latched and locked.

## Exterior Door Locations



## Passenger Entry Doors

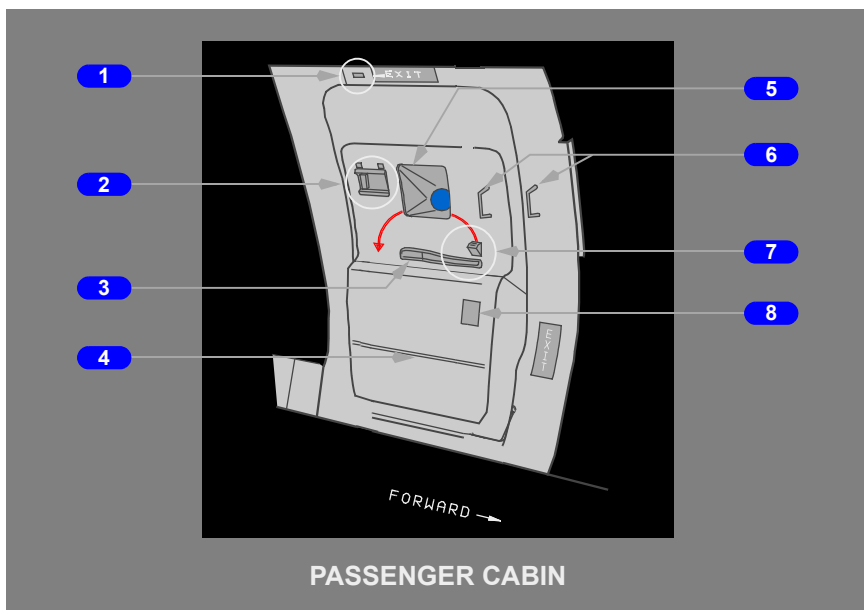

### 1 Girt Bar Engagement Indicator (SLIDE) Light

Illuminated (amber) – door and slide are armed.

### 2 Door Mode Select Panel

See following graphic.

### 3 Door Operating Handle

To open the door – rotate in the direction of the arrow.

To close the door – rotate in the opposite direction of the arrow.

### 4 Slide

The bustle contains the slide.

**Note:** The slide is also configured as a raft.

### 5 Viewing Window

Allows observation outside the airplane.

### 6 Door Assist Handles

Used to assist in opening/closing the door.

## 7 Slide Placard

In view – door and slide are armed.

Not in view– slide is disarmed.

## 8 Slide Gas Bottle Pressure Gage

Maintenance use only.

## Door Mode Select Panel

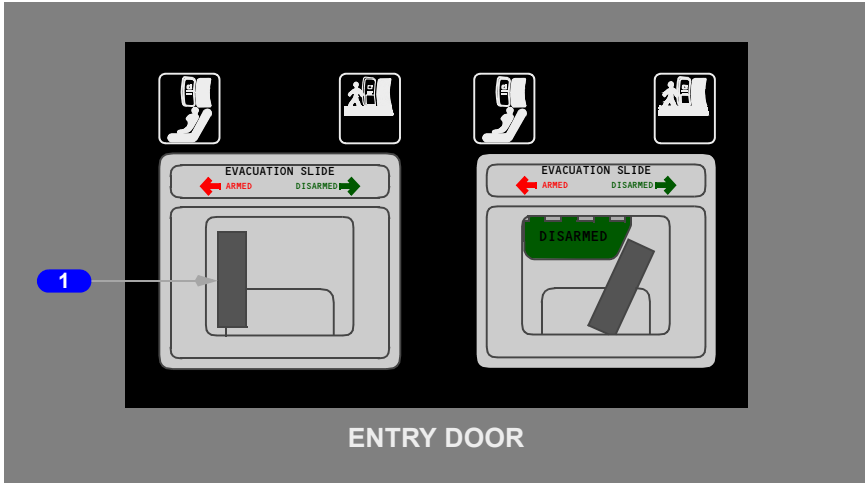

### 1 Slide Arming Lever

**ARMED**–If the door handle is moved to open, the door is powered open, and the slide deploys.

**Note:** If the door is opened from the outside, the slide will not deploy.

**DISARMED**–If the door handle is moved to open, the power assist door opening is disabled and the slide will not deploy.

## Emergency Doors

### [Option-Emergency Doors]

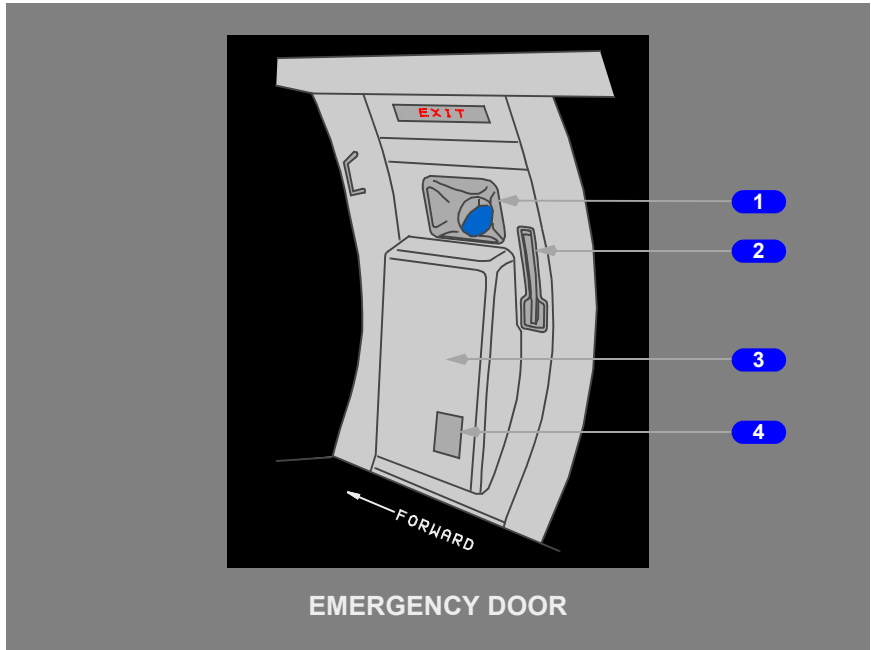

**1 Viewing Window**

Allows observation outside the airplane.

**2 Door Operating Handle**

Pull – opens door and deploys slide.

**3 Slide**

The bustle contains the slide.

**4 Slide Gas Bottle Pressure Gage**

Maintenance use only.

## Overwing Emergency Exit Doors

[Option-200 Overwing Emergency Exit]

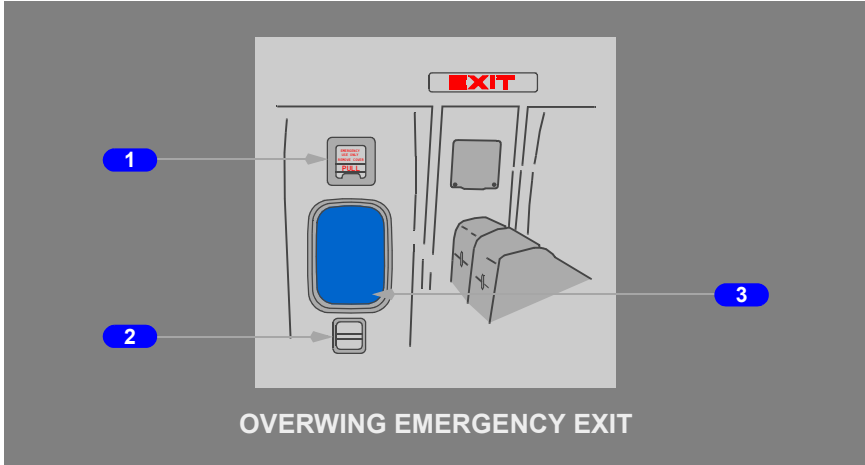

### 1 Emergency Handle

**Note:** Cover must be removed to access emergency handle.

To open the door and deploy the ramp slide – pull the handle.

### 2 Door Assist Handle

Used to assist in removing the door from the opening.

### 3 Alternate Deployment Handle

**Note:** Door must be removed to access.

To manually deploy ramp slide in the event the normal system fails – pull the handle.

## Flight Deck Door

(SB Adds BC001, BC002 with a enhanced security flight deck door installed.)

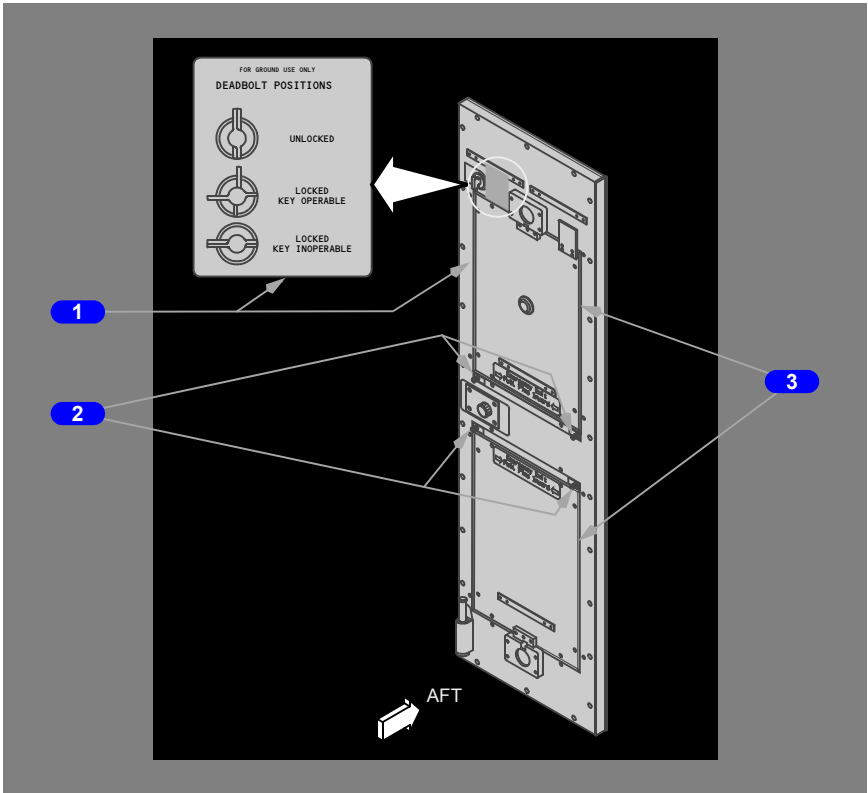

### 1 Deadbolt and Deadbolt Placard

### 2 Release Pins

Pull pins inward - manually separates decompression panel from a jammed door to allow panel opening and egress.

### 3 Decompression Panel

Automatically opens during cabin depressurization and provides emergency egress path.

## Flight Deck Emergency Access Panel

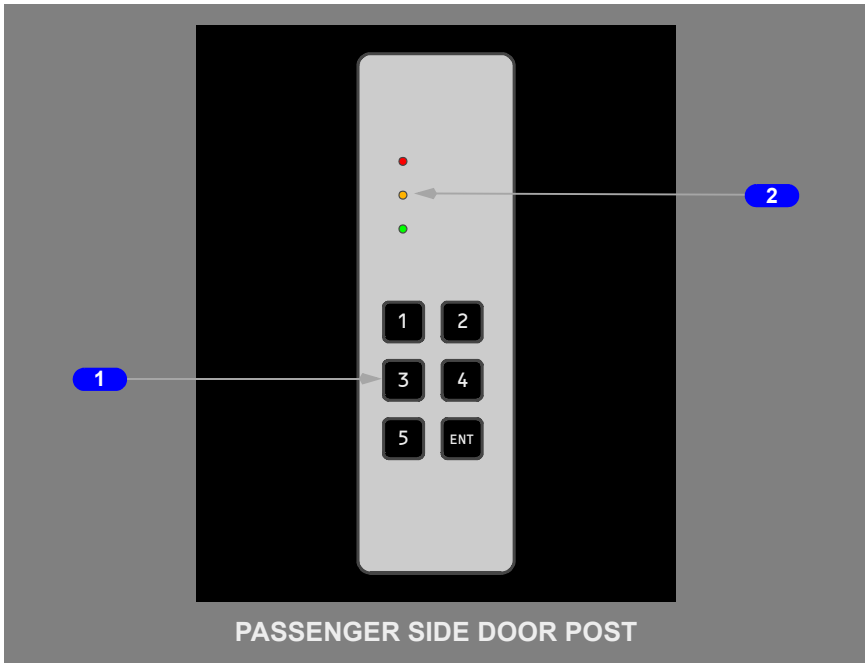

### 1 Keypad

Push - enters 3 to 8 digit emergency access code by pressing numeric then "ENT" keys. Entry of correct emergency access code sounds flight deck chime.

### 2 Access Lights

Illuminated (red) - door locked or Flight Deck Access System switch OFF.

Illuminated (amber) - correct emergency access code entered.

Illuminated (green) - door unlocked.

## Flight Deck Access System Switch

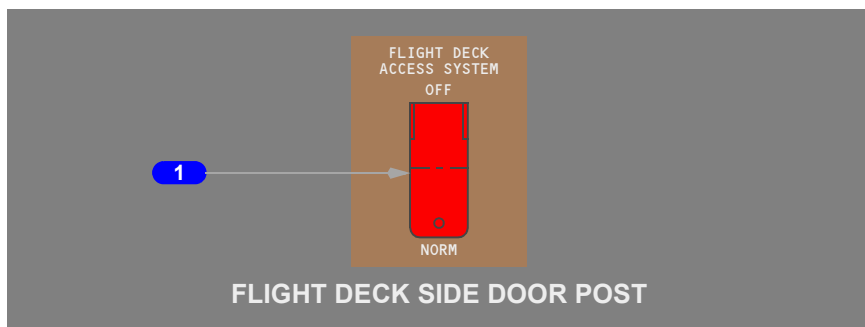

### 1 Power Cutoff Switch

OFF - removes electrical power from door lock.

NORM (Normal) - flight deck access system configured for flight.

## Flight Deck Door Lock Panel

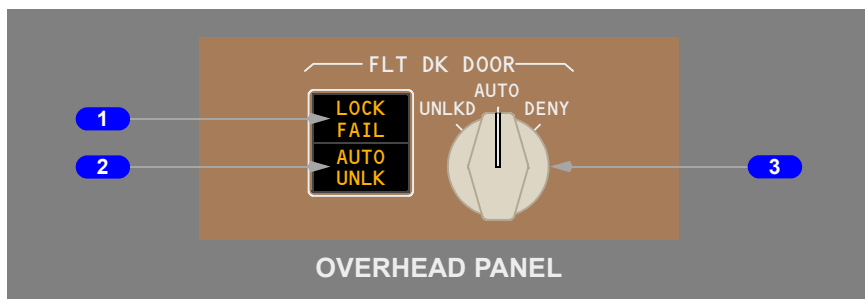

### 1 LOCK FAIL Light

Illuminated (amber) - door lock selector in AUTO position and door lock has failed or Flight Deck Access System switch in OFF.

### 2 AUTO Unlock (UNLK) Light

Illuminated (amber) - correct emergency access code entered in keypad. AUTO UNLK light flashes and continuous chime sounds before timer expires and door unlocks.

### 3 Flight Deck Door (FLT DK DOOR) Lock Selector

Spring loaded to AUTO. Selector must be pushed in to rotate from AUTO to UNLKD position. Selector must not be pushed in to rotate from AUTO to DENY position.

UNLKD - door unlocked while selector in UNLKD.

AUTO - door locked. Allows door to unlock after entry of emergency access code and expiration of timer, unless crew takes action.

DENY - rejects keypad entry request and prevents further emergency access code entry for a time period.

## Flight Deck Door Switch

(SB Deletes BC001, BC002 with unmodified flight deck door switch.)

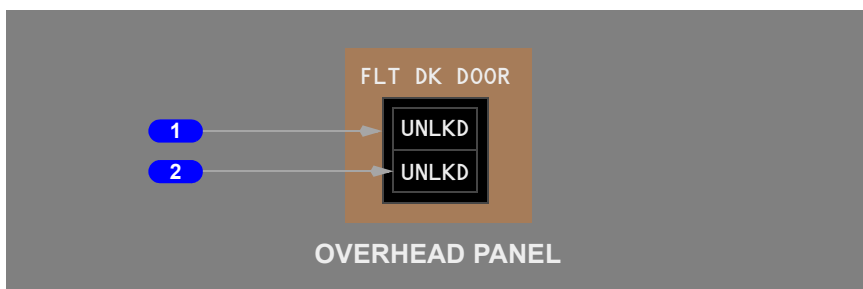

### 1 Flight Deck (FLT DK) DOOR Switch

Unlocked (UNLKD) –

- the door unlocks
- the door remains in the closed position

Locked (UNLKD not visible) – the lock engages when the door is closed.

### 2 Flight Deck Door Unlocked (UNLKD) Light

Illuminated (white) – switch is in the door locked position but door is open and not locked.

Blank – door is closed and locked.



## Flight Deck Number Two Window

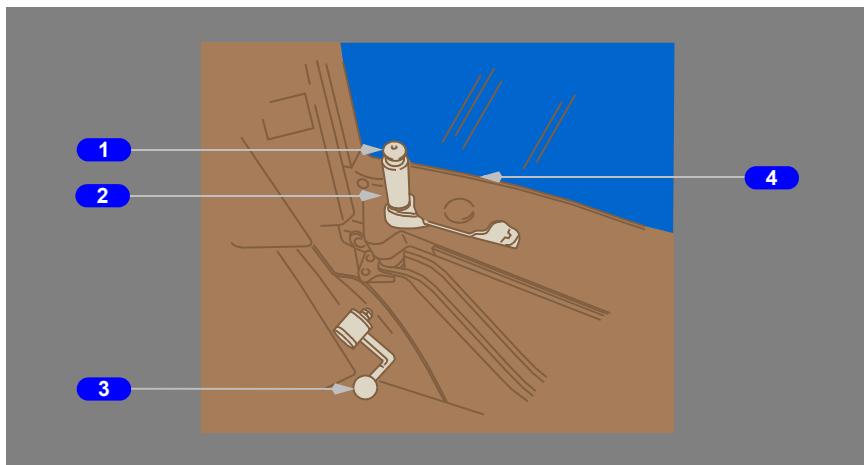

### **1 Window Lock Release Button**

Button must be depressed to free the Window Lock Lever from the Forward Position.

### **2 Window Lock Lever**

Forward – with the window fully closed (WINDOW NOT CLOSED decal not visible), locks the window.

Aft – unlocks the window so it can be cranked open.

### **3 Window Crank**

Used to position the window open or closed when the window lock lever is unlocked.

### **4 WINDOW NOT CLOSED Decal**

Visual indication the window is not fully closed.

## Oxygen Systems

### Oxygen Indications

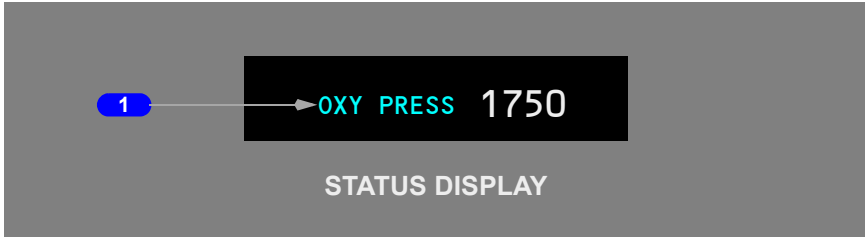

#### 1 Oxygen Pressure (OXY PRESS) Display

Displays crew oxygen cylinder pressure (psi).

### Passenger Oxygen Switch

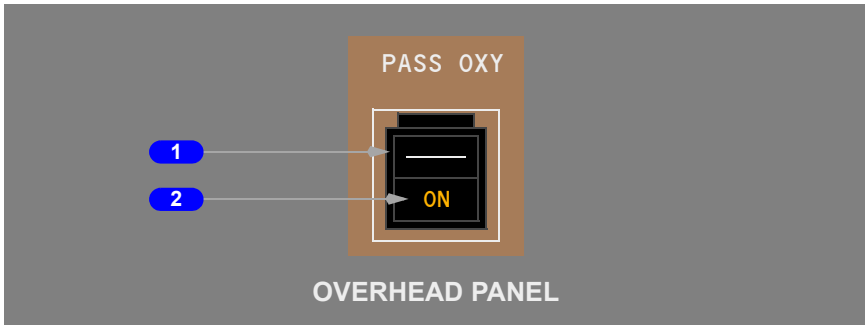

#### 1 Passenger Oxygen (PASS OXY) Switch

Push – the passenger cabin oxygen masks drop.

#### 2 Passenger Oxygen ON Light

Illuminated (amber) – the passenger oxygen system is operating and the masks have dropped.

## Oxygen Mask Panel

[Option-Scott EROS Oxygen Mask with vent valve installed]

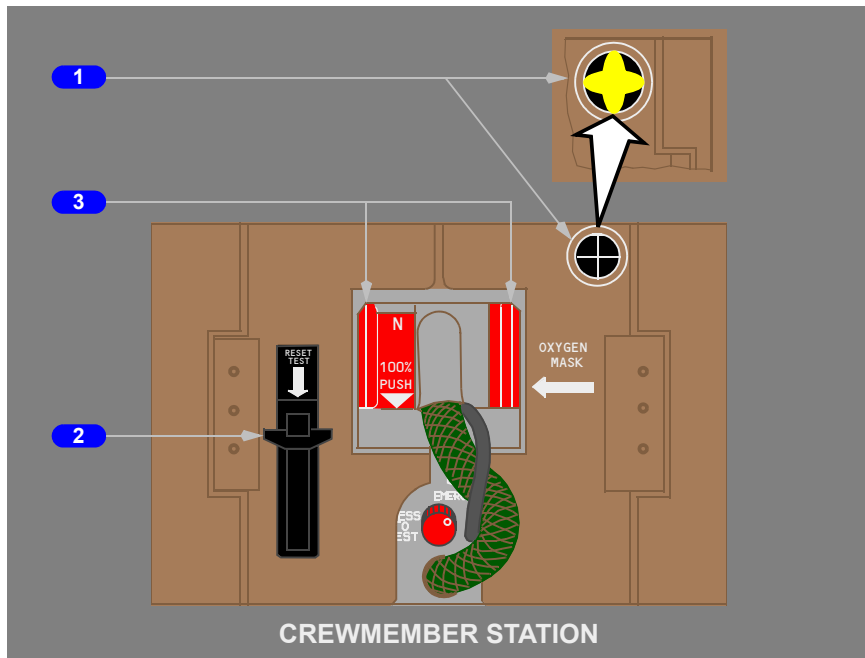

[Option-Scott Full Face Oxygen Mask installed]

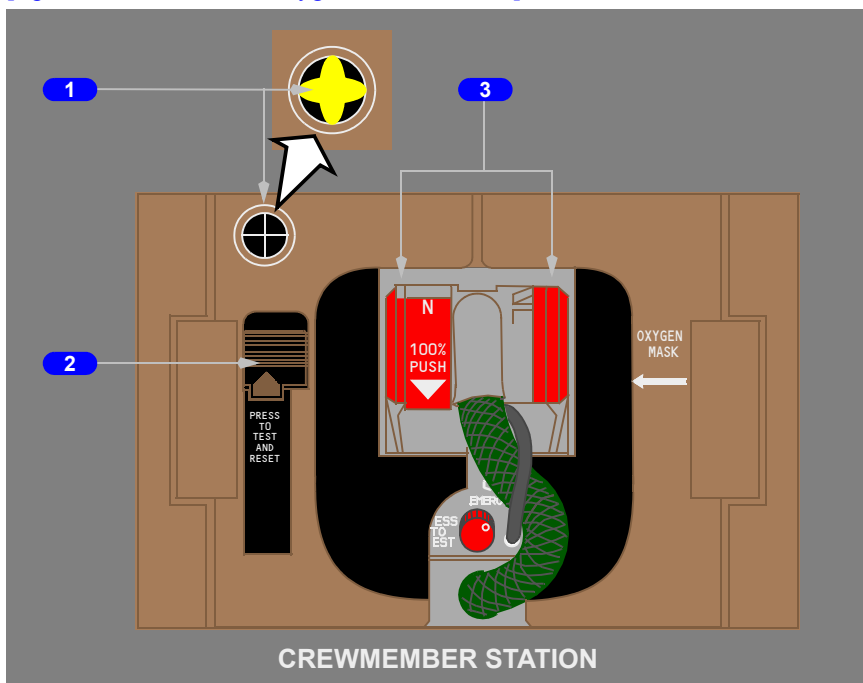

### 1 Oxygen Flow Indicator

Shows a yellow cross when oxygen flowing.

### 2 RESET/TEST Switch

Push –

- with the left oxygen panel door closed and OXY ON flag not displayed, turns oxygen on momentarily to test the regulator
- with the left oxygen panel door closed and the OXY ON flag displayed, turns oxygen off

### 2 PUSH TO TEST AND RESET Switch

Push –

- with the left oxygen panel door closed and OXY ON flag not displayed, turns oxygen on momentarily to test the regulator
- with the left oxygen panel door closed and the OXY ON flag displayed, turns oxygen off

### 3 Oxygen Mask Release Levers

Squeeze and pull –

- unlocks the oxygen panel doors
- releases the mask
- oxygen turns on when the oxygen panel doors open

Squeeze (right lever) – inflates the mask harness.

Release – deflates the mask harness into position on the head and face.

## Oxygen Mask and Regulator

[Option-Scott EROS Oxygen Mask with vent valve installed]

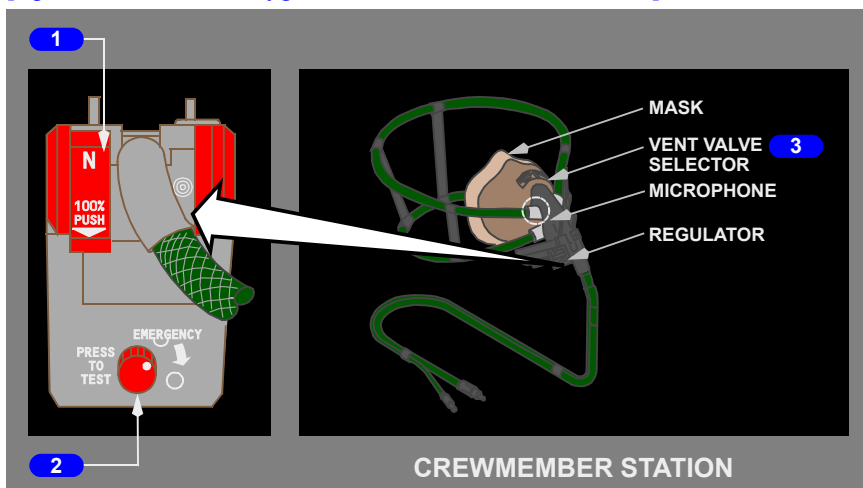

[Option-Scott Full Face Oxygen Mask installed]

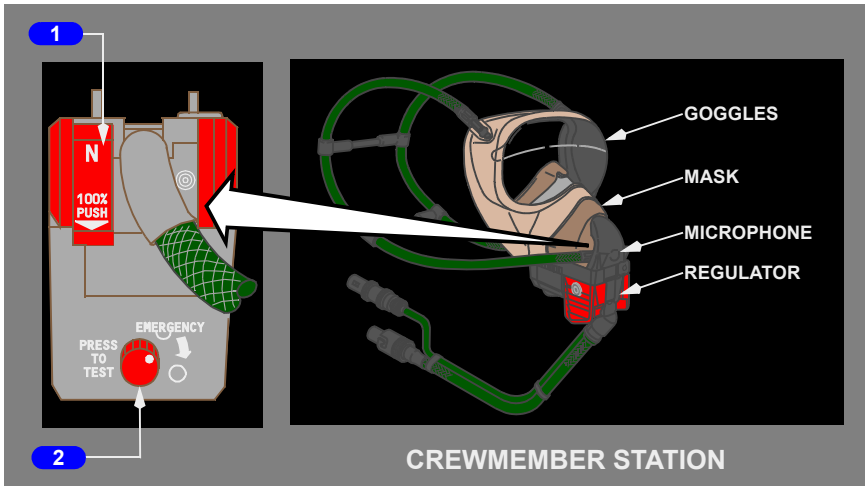

**1 Normal (N)/100% Switch**

N – supplies an air/oxygen mixture on demand (the ratio depends on cabin altitude).

100% – supplies 100% oxygen on demand (not an air/oxygen mixture).

**2 Oxygen Mask Emergency/Test Selector**

Rotate (in the direction of the arrow) – supplies 100% oxygen under positive pressure at all cabin altitudes (protects against smoke and harmful vapors).

PRESS TO TEST – tests the positive pressure supply to the regulator.

**3 Smoke Vent Valve Selector**

Up – vent valve closed

Down – vent valve open, allowing oxygen flow to smoke goggles.

---

## **Introduction**

This chapter describes miscellaneous airplane systems, including:

- lighting systems
- oxygen systems
- doors and windows
- flight deck seats

---

## **Lighting Systems**

Lighting systems described in this chapter include:

- exterior lighting
- flight deck lighting
- passenger cabin signs
- emergency lighting

## **Exterior Lighting**

Exterior lighting consists of these lights:

- landing
- runway turnoff
- anti-collision
- navigation (position)
- wing leading edge illumination
- logo

## **Landing Lights**

The landing lights consist of the left, right, and nose gear landing lights. The left and right landing lights are located in the left and right wing root and are optimized for flare and ground roll. The two nose gear-located landing lights are optimized for approach.

The nose gear landing lights are inoperative when the nose landing gear is not down and locked.

## **Runway Turnoff Lights**

Two runway turnoff lights are mounted on the nose landing gear. They are inoperative when the nose landing gear is not down and locked.

## White Anti-Collision Lights

The white anti-collision lights are strobe lights located on each wing tip.

## Red Anti-Collision Lights

The red anti-collision lights are strobe lights located on the top and bottom of the fuselage.

## Navigation Lights

The navigation lights are standard red (left forward wingtip), green (right forward wingtip), and white (aft tip of both wings) position lights.

## Wing Lights

Wing lights are installed on the fuselage and illuminate the leading edge of the wing.

## Logo Lights

Logo lights are located on the stabilizer to illuminate the logo on the vertical tail surface.

## Exterior Lighting Locations

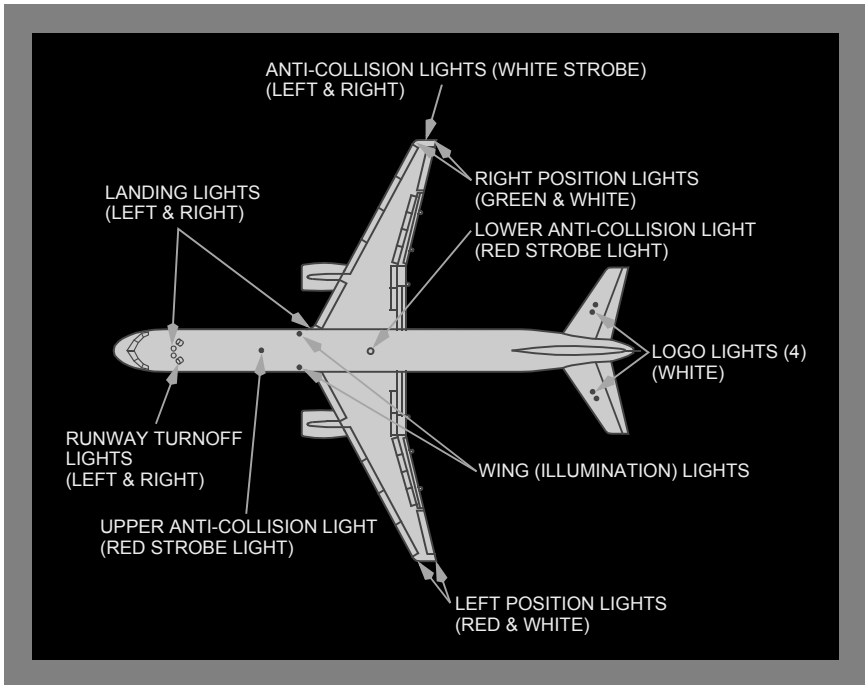



## Flight Deck Lighting

Flight deck lighting is provided for panel illumination, area lighting, and localized illumination. Flood lights and light plates provide panel illumination. Dome lights provide flight deck area lighting. Map lights, chart lights, and utility lights provide localized illumination.

Panel and flood lights illuminate the forward panels, glareshield, and aisle stand panels. When the light override switch is ON, the forward panel flood lights, glareshield flood lights, dome lights, aisle stand flood lights, and all illuminated annunciator lights illuminate at full brightness.

If normal electrical power is lost, the standby magnetic compass light, forward panel flood lights, and integral lights for essential instruments on the left forward, center forward, and overhead panels are automatically switched to the Standby AC bus.

## Indicator Lights

Indicator Light brightness can be set to DIM or BRT with the indicator lights selector. The system automatically overrides the DIM position and illuminates the indicator lights full bright if the ambient flight deck light level increases to a preset crossover light value as detected by system sensors located on the center forward panel.

## Passenger Cabin Signs

The passenger cabin signs are controlled by overhead panel selectors. The passenger signs illuminate when the following conditions are satisfied:

FASTEN SEAT BELTS signs (AUTO selected):

- landing gear not up and locked, or
- flap lever not up, or
- cabin altitude above 10,000 feet, or
- passenger oxygen on

NO SMOKING signs (AUTO selected):

- landing gear not up and locked, or
- cabin altitude above 10,000 feet, or
- passenger oxygen on

All passenger signs can be controlled manually by positioning the respective selector to ON or OFF. When the FASTEN SEAT BELTS and NO SMOKING selectors are in the OFF position, and oxygen is ON, the FASTEN SEAT BELTS and NO SMOKING signs illuminate.

RETURN TO SEAT signs are illuminated with the FASTEN SEAT BELTS signs, except when oxygen is deployed.

---

When the passenger signs illuminate or extinguish, a low tone sounds over the PA system.

## **Emergency Lighting**

Emergency lighting is controlled by the emergency lights switch on the overhead panel. The switch can be used to manually activate or arm the system for automatic operation. Automatic operation occurs if DC power fails or is turned off when the system is armed. The emergency lighting system can also be controlled by the flight attendants emergency lights switch.

The emergency lighting system is powered by remote batteries. Battery charge is maintained by the airplane electrical system. A fully charged battery provides at least 15 minutes of operation.

The UNARMED light illuminates and the EICAS advisory message EMER LIGHTS is displayed if the emergency lights switch is not in the ARMED position.

### **Interior Emergency Lighting**

Interior emergency lighting consists of door, aisle, escape path, exit lights, and luminescent exit signs.

Escape path lighting consists of floor mounted locator lights spaced at intervals in the aisle and exit indicators by each door. When illuminated, escape path lighting provides visual guidance for emergency evacuation if all sources of lighting more than four feet above the aisle floor are obscured by smoke.

Battery powered exit lights are located at each cabin exit.

### **Exterior Emergency Lighting**

Exterior emergency lights are located at each entry door and emergency door. Lights are also installed in each slide to illuminate the ground at the end of the slide.

Exterior emergency lights are located at each entry door, and overwing emergency exit door. Lights are also installed in each slide to illuminate the ground at the end of the slide.

---

## **Oxygen Systems**

Two independent oxygen systems are provided, one for the flight crew and one for the passengers. Portable oxygen cylinders are located throughout the airplane for emergency use.

## Flight Crew Oxygen System

The flight crew oxygen system uses quick-donning masks and regulators located at each crew station. Oxygen pressure is displayed on the lower EICAS status display.

Flight crew and observer masks and regulators are installed in oxygen mask panels near each seat. Squeezing the red oxygen mask release levers releases the mask from stowage. Removing the mask:

- inflates the mask harness
- momentarily displays the yellow oxygen flow indicator

Place the mask over the head and release the levers. The harness will contract fitting the mask to the head and face.

## Passenger Oxygen System

The passenger oxygen system is supplied by individual chemical oxygen generators. The oxygen system provides oxygen to the passenger, attendant stations, and lavatory service units. The passenger oxygen masks and chemical oxygen generators are located above the passenger seats in passenger service units (PSUs). Oxygen flows from a PSU generator when any mask hanging from that PSU is pulled. The masks automatically drop from the PSUs if cabin altitude exceeds 14,000 feet. The passenger masks can be manually deployed from the flight deck by pushing the passenger oxygen switch. The passenger oxygen ON light illuminates and EICAS advisory message PASS OXYGEN ON displays when the system is activated.

## Portable Oxygen Bottles

Portable oxygen bottles are stowed in various locations in the passenger cabin. The bottles are fitted with disposable masks and are used for first aid purposes or as walk-around units.

---

## Doors and Windows

The airplane has six passenger entry doors, four overwing emergency exit doors, one flight deck door (the flight deck/passenger cabin entry), and two cargo doors. It also has electrical equipment and forward equipment bay access doors.

The flight deck number two windows, one on the left and one on the right, can be opened by the flight crew.

**CAUTION: Do not operate the entry and cargo doors with winds at the door of more than 40 knots. Do not keep the door open when wind gusts are more than 65 knots. Strong winds can cause damage to the structure of the airplane.**

An EICAS message is displayed when a passenger entry door, overwing emergency exit door, cargo door or access door is not closed, and latched, and locked.

## **Flight Deck Door**

(SB Adds BC001, BC002 with enhanced security flight deck door.)

The flight deck security door meets requirements for resistance to ballistic penetration and intruder entrance. The door opens into the passenger cabin. There is a step between the flight deck and the cabin. When closed, the door locks when electrical power is available and unlocks when electrical power is removed. A viewing lens in the door allows observation of the passenger cabin. The door can be manually opened from the flight deck by turning the door handle.

The door incorporates a deadbolt with a key lock. Rotating both concentric deadbolt levers to the locked (horizontal) position prevents the passenger cabin key from unlocking the door. Rotating only the forward deadbolt lever to locked allows the key to unlock the door.

The flight deck access system consists of an emergency access panel, chime module, Door Lock selector, two indicator lights, and an Access System switch. The emergency access panel includes a six button keypad for entering the numeric access code along with red, amber, and green lights. The red light illuminates to indicate the door is locked. When the correct emergency access code is entered, the amber light illuminates. The green light illuminates to indicate the door is unlocked.

Two indicator lights and a three position Door Lock selector are located on the overhead panel. Illumination of the amber LOCK FAIL light indicates the door lock has failed or the Access System switch is in the OFF position.

The emergency access code is used to gain access to the flight deck in case of pilot incapacitation. Annunciation of a flight deck chime and illumination of the amber AUTO UNLK light indicates the correct emergency access code has been entered and the door is programmed to unlock after a time delay. Selecting the DENY position on the Door Lock selector denies entry and prevents further keypad entry for several minutes. To allow entry, the selector is turned to the UNLKD position which unlocks the door while held in that position. If the emergency access code is entered and the pilot takes no action, the door unlocks after expiration of the time delay. Before the door unlocks, the chime sounds continuously and the AUTO UNLK light flashes.

By pressing "1" then "ENT" keys on the emergency access panel, the flight deck chime will sound (if programmed).

The door incorporates two pressure sensors that unlock the decompression panels in the event of flight deck depressurization. These panels open to equalize pressure in the event of cabin depressurization at a pre-determined value. The decompression panels have manual release pins. Pulling the pins frees the panels allowing egress in the event the door is jammed.

(SB Deletes BC001, BC002 with basic Flight Deck Door.)

The flight deck door opens into the cabin. There is a step between the flight deck and the cabin.

An electric lock latch mechanism, controlled by the flight deck door switch, allows the flight deck door to be locked. The door can be opened at any time from the flight deck side. When the door is locked, a key is required to open the door from the passenger cabin side. The door unlocks automatically with the loss of electric power.

A break-away feature allows the door to be forced open in either direction for emergency access to or evacuation from the flight deck.

**CAUTION: Forcing the door open into the passenger cabin causes permanent damage.**

## **Flight Deck Number Two Windows**

The flight deck number two windows can be opened from the inside on the ground or in flight. The flight deck number two windows can be used for emergency evacuation. Pressing the Window Lock Release Button frees the Window Lock Lever. The Window Lock Lever locks or unlocks the window. Rotating the window crank opens and closes the window.

A WINDOW NOT CLOSED placard is visible when the window is open.

The windows can be opened or closed in flight with minor flight deck consequences if the airplane is unpressurized. The force required to move the crank increases with airspeed. With the window open, voice, interphone, and radio audio may not be heard due to high noise levels. Prior communications arrangements with the controlling agency should be established before opening the window. The design provides an area of relatively calm air over the open window. Forward visibility can be maintained by looking out of the open window.

## Flight Deck Window Emergency Egress

If the flight deck number two windows must be used for emergency evacuation, exit in accordance with the following illustration.

**CAUTION: Ensure the rope is securely fastened to the airplane.**

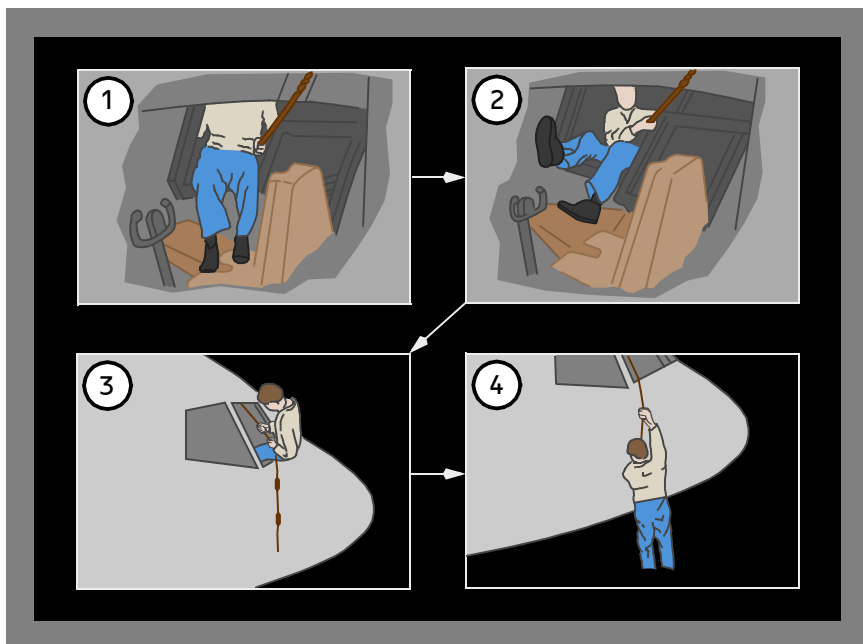

## Passenger Entry Doors

The passenger entry doors are used to enter and exit the airplane, and also serve as emergency exits. The passenger entry doors are paired along the airplane fuselage. The doors can be opened or closed manually from inside or outside of the airplane.

The entry doors are plug-type doors. During opening, the door first moves inward, then rotates outward and forward. Each door is held in the open position by a gust lock. The gust lock drops into a latch as the door nears its forward limit of travel. A window in each door allows observation outside of the airplane.

The ENTRY DOORS light illuminates and the EICAS advisory message L AFT, L CTR, L FWD, R AFT, R CTR or R FWD ENT DOOR displays when a passenger entry door is not closed and latched and locked. If two doors on the same side of the airplane are not closed and latched and locked, the EICAS advisory message L or R ENTRY DOORS displays.

## Passenger Entry Door and Slide Operation

Emergency evacuation slide and pneumatic door opening systems are provided for each passenger entry door. Each door system has enough power to open the door unassisted, even if the airplane is not level because of any landing gear collapse condition. A slide bustle in the lower face of the door contains the slide.

For normal operations, the slide must be disarmed before opening the door. Moving the mode select lever to DISARMED causes the slide girt bar to detach from the floor, the SLIDE light to extinguish, the mechanical SLIDE ENGAGED warning placard to retract.

When the door is disarmed the spring-loaded DISARMED placard will rotate down into view.

The emergency door opening system is armed when the mode select lever is in the ARMED position. This engages the slide girt bar and arms both the slide and the emergency door opening systems. The SLIDE light above the door illuminates and the slide placard extends out over the door operating handle. Once armed, moving the interior door operating handle to the open position unlocks the door and moves it inside to the cocked position. The door can then be pushed out through the door frame. The first outward movement of the door activates the emergency door opening system, which drives the door open, and the slide automatically deploys and inflates.

A manual inflation handle can be pulled if the slide has not automatically inflated.

The emergency door opening system and the slide are automatically disarmed when the door is opened from the outside. If the mode select lever is in the ARMED position and the door is opened using the exterior door handle, the mode select lever automatically moves to DISARMED and the door opens without slide deployment.

[Option-Certified as rafts]

The passenger door evacuation slides are also configured as rafts.

## Escape Slide Deployed

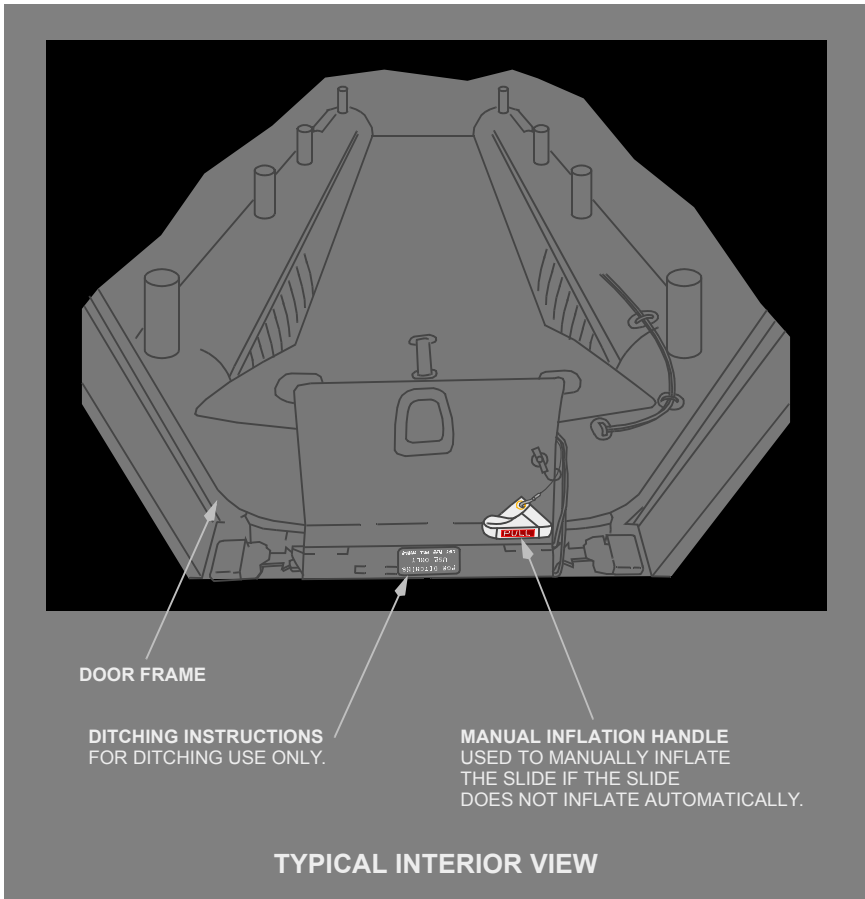

## Emergency Doors

### [Option-Certified Type 1 Emergency Doors aft of wing]

An emergency door is located aft of the wing on each side of the airplane. The emergency door is only used as an emergency exit. A slide bustle in the lower face of the door contains an evacuation slide. A window in the door allows observation outside of the airplane.

The emergency door is a plug-type door and is hinged on the bottom. Pulling the door operating handle up lifts the door inward and upward and opens a pressure relief door. The door can then be pushed out through the door frame and the slide automatically deploys and inflates.

A manual inflation handle can be pulled if the slide has not automatically inflated.



The EMER DOORS light illuminates and the EICAS advisory message L or R EMER DOOR displays when an emergency door is not closed and latched and locked. If both doors are not closed and latched and locked, the EICAS advisory message EMER DOORS displays.

The emergency door evacuation slides are not configured as rafts, however they may be used as auxiliary flotation devices.

## **Overwing Emergency Exit Doors**

**[Option-Certified Type 3 called Over Wing Emergency Exit Doors on 757-200]**

**[Option-Certified Type 3 called Wing Doors on 757-300]**

Forward and aft overwing emergency exit doors are located over the wing on each side of the airplane. The overwing emergency exit doors are only used as emergency exits. An overwing evacuation ramp and slide assembly is contained in an exterior compartment near the aft edge of each wing. A window in the door allows observation outside of the airplane.

The overwing emergency exit door is a plug-type hatch. The emergency PULL handle opens the door. The door can then be removed from the opening. Opening the overwing emergency exit door automatically deploys and inflates the ramp and slide.

A manual inflation handle can be pulled if the ramp and slide has not automatically inflated.

The overwing emergency exit door ramp and slide is automatically disarmed when the door is opened from the outside.

The EMER DOORS light illuminates and the EICAS advisory message L AFT, L FWD, R AFT or R FWD EMER DOOR displays when an overwing emergency exit door is not closed and latched and locked. The EMER DOORS light also illuminates and the EICAS advisory message L or R WING SLIDE displays if the door to the ramp slide stowage compartment is not closed and latched and locked. The EICAS advisory message EMER DOORS displays if two or more overwing emergency exit doors or wing slide doors are not closed and latched and locked.

The overwing emergency exit door ramps and slides are not configured as raft and they may not be used as auxiliary flotation devices.

## Overwing Door

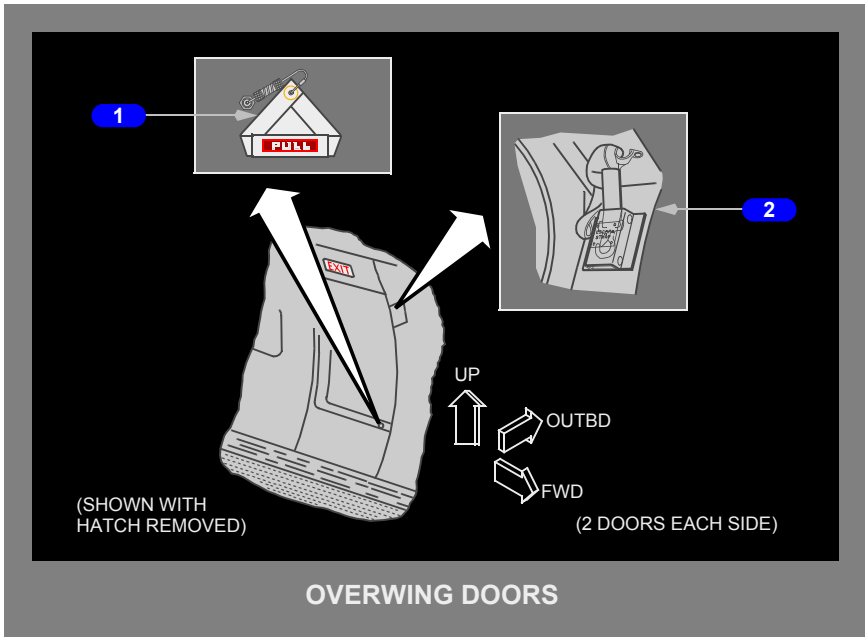

### 1 Manual Inflation Handle

Pull – Deploys ramp slide in the event normal system fails.

- one per exit

### 2 Escape Strap (Aft Door only)

Remove Cover – Pull out and attach hook to wing fitting

## Evacuation Slides

[Option- 767-200 with overwing exits.]

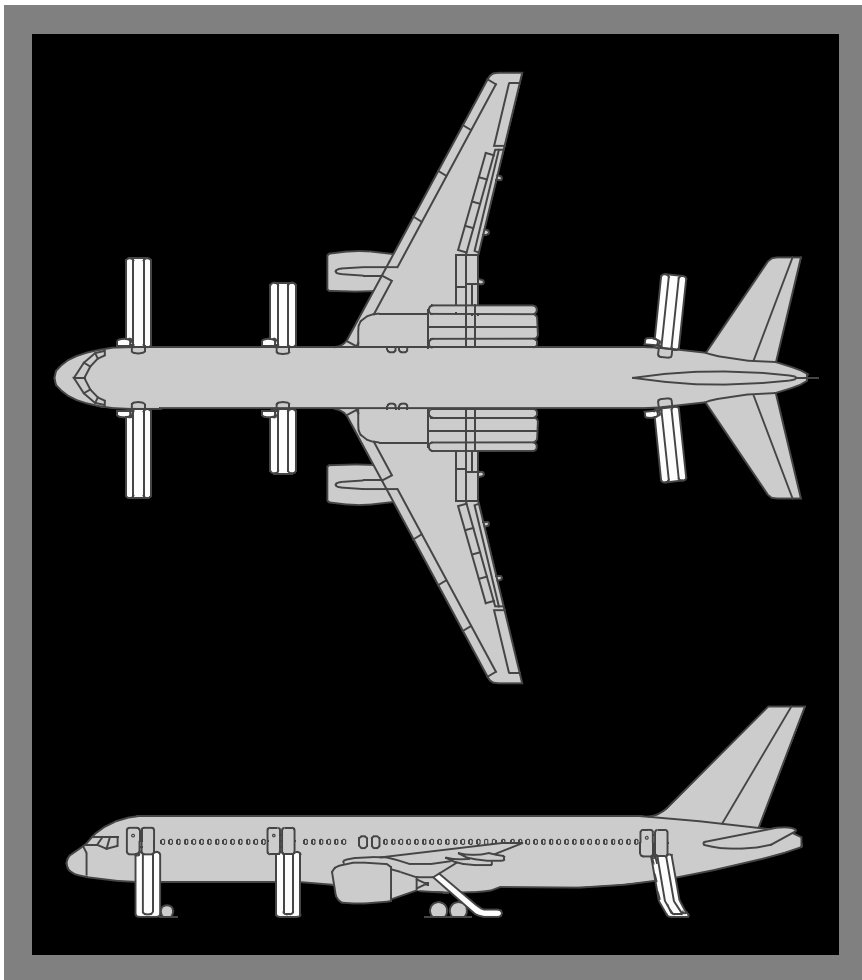

[Option- 767-200 with emergency doors.]

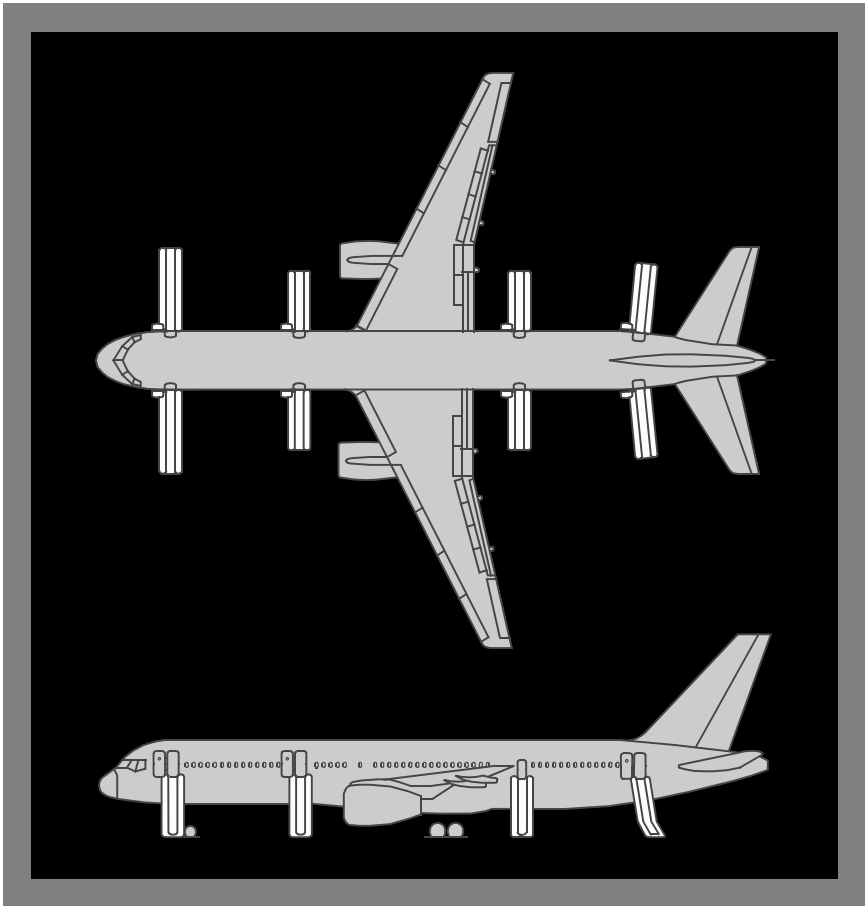

## Cargo Doors

There are two cargo doors; one forward and one aft. Both doors are located on the right side of the airplane. The cargo doors open upward and outward.

Both forward and aft cargo doors are normally operated electrically from an exterior or interior fuselage-mounted control panel located with each door. Forward and aft cargo door locking is accomplished manually. If necessary, the forward and aft cargo doors may be operated manually.

The CARGO DOORS light illuminates and the EICAS advisory message FWD or AFT CARGO DOOR displays when any cargo door is not closed and latched and locked. The EICAS advisory message CARGO DOORS displays if both cargo doors are not closed and latched and locked.

## **Flight Deck Seats**

The pilot seats:

- recline
- adjust vertically
- adjust forward and aft
- adjust for thigh support
- adjust for the lumbar region of the back

The seats also have:

- adjustable armrests
- crotch straps
- inertial–reel shoulder harnesses with manual locks
- lap belts
- adjustable headrests

The seats move outboard during the last four inches of travel. Manual controls provide forward, aft, and vertical adjustment.

Lumbar and thigh pad support can be adjusted using the adjustment hand wheels. Armrest pitch can be adjusted using the control knob under the armrest. The armrests can be stowed vertically for easier seat access.

Adjust the seat to obtain the optimum eye position as shown on the following illustration.

## Pilot Seat Adjustment

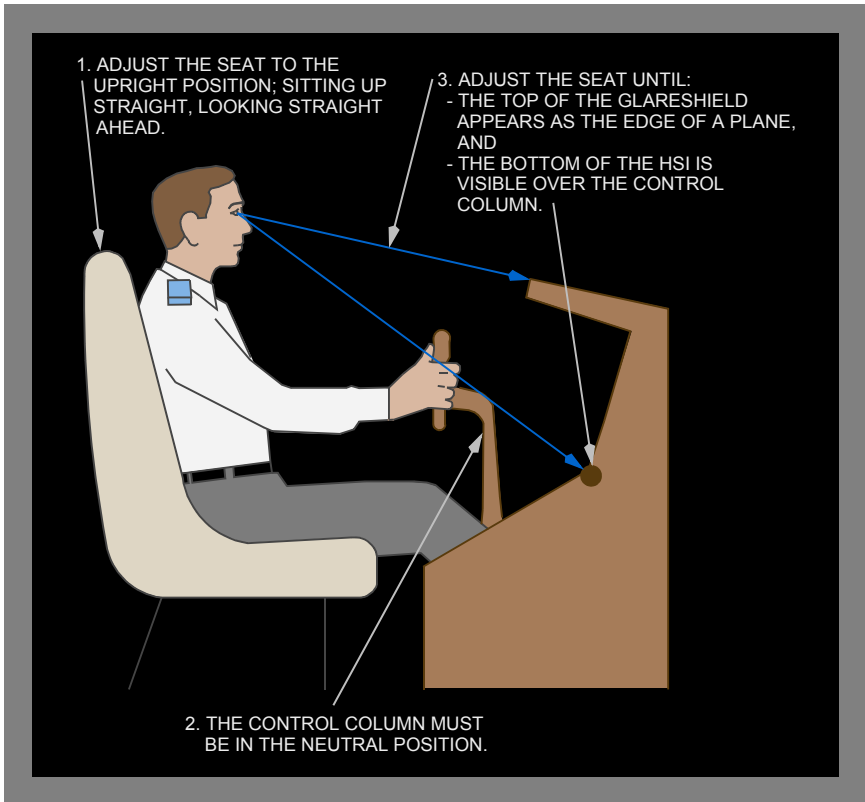

---

## Introduction

This chapter describes miscellaneous airplane systems, including:

- emergency equipment
- emergency equipment locations

---

## Emergency Equipment

Emergency equipment described in this section includes:

- fire extinguishers
- miscellaneous emergency equipment

## Fire Extinguishers

Fire extinguishers are located throughout the aircraft. See emergency equipment diagram for location.

The type of fire extinguishers are as follows:

- Halon (BCF)
- Carbon Dioxide (CO<sub>2</sub>)

**WARNING:** If a fire extinguisher is to be discharged in the flight deck area, all flight crew members must wear oxygen masks and use 100% oxygen with emergency selected.

**CAUTION:** For electrical fires, remove the power source as soon as possible. Avoid discharging directly on persons due to possibility of suffocating effects. Do not discharge too close to fire as the discharge stream may scatter the fire. As with any fire, keep away from the fuel source. Avoid breathing vapors, fumes, and heated smoke as much as possible.

## Halon Fire Extinguishers

Halon fire extinguishers contain a liquefied gas agent under pressure. The extinguisher pressure indicator shows three pressure ranges:

- acceptable
- recharge
- overcharged

A safety pin with a pull ring prevents accidental trigger movement. When released, the liquefied gas agent vaporizes and extinguishes the fire. The extinguisher is effective on all types of fires, but is used primarily on electrical, fuel, and grease fires.

Direction for use of the fire extinguisher is printed on the extinguisher.

### **Carbon Dioxide (CO<sub>2</sub>) Fire Extinguishers**

The Carbon Dioxide extinguisher is most effective on fires involving flammable liquids, greases etc. where a blanketing effect is essential. CO<sub>2</sub> is very effective on fires in "live" electrical equipment, where the use of an electrically non-conductive agent is of first importance. Carbon Dioxide is not harmful to fabrics or instruments, but will cause frostbite if directed on bare skin. Avoid grasping the discharge nozzle for similar reasons.

To use the Carbon Dioxide fire extinguisher, hold the extinguisher upright and rotate the nozzle. Aim the extinguisher nozzle at the base of the flame and pull the trigger.

### **Miscellaneous Emergency Equipment**

Additional equipment is stowed at strategic locations throughout the airplane. This may include a crash axe, megaphones, flashlights and first aid kits. Life vests are stowed at each crew member station and at each passenger seat.

### **Emergency Locator Transmitters (ELTs)**

ELTs are installed in slide/raft bustles. The ELTs automatically transmit when submerged in water.





























Portable ELT's may be installed in the passenger cabin, as shown in the Emergency Equipment Locations diagram.

### **Escape Ropes**

Escape ropes are attached to the airplane structure above both number two flight deck windows. The ropes are stowed in compartments above the pilot seats. Prior to dropping the rope out of the window, ensure the rope is attached by pulling down.





## Emergency Equipment Symbols

						
CO <sub>2</sub> EXTINGUISHER	H <sub>2</sub> O EXTINGUISHER	HAL EXTINGUISHER	PRY BAR	FLARE KIT		
						
PORTABLE OXYGEN BOTTLE	PORTABLE OXYGEN BOTTLE WITH MASK	PORTABLE BREATHING EQUIPMENT (PBE)	SMOKE HOOD	SLIDE/RAFT SURVIVAL KIT		
						
EMERGENCY EXIT PATH	EXIT PATH WITH ESCAPE ROPE	EXIT PATH WITH ESCAPE SLIDE	EXIT PATH WITH ESCAPE SLIDE AND ROPE	EXIT PATH WITH SLIDE/RAFT		
						
LIFE RAFT	ELT	LIFE VEST	PROTECTIVE GLOVES	SMOKE GOGGLES	CRASH AXE	MEGAPHONE
						
BATON	HANDCUFFS	FLASHLIGHT	EMERGENCY MEDICAL KIT	FIRST AID KIT	RESUSCITATOR KIT	

**NOTE:** Some symbols do not apply to all configurations.

**NOTE:** ("n") below symbol means quantity greater than one.

A = Attendant Station	 = Ceiling Storage
P = Purser Station	 = Overhead Storage Bin
GAL = Galley	
LAV = Lavatory	
CLO = Closet	

## Emergency Equipment Locations

[Option - 8 door configuration (i.e. 6 entry, 2 aft of wing emergency doors)]

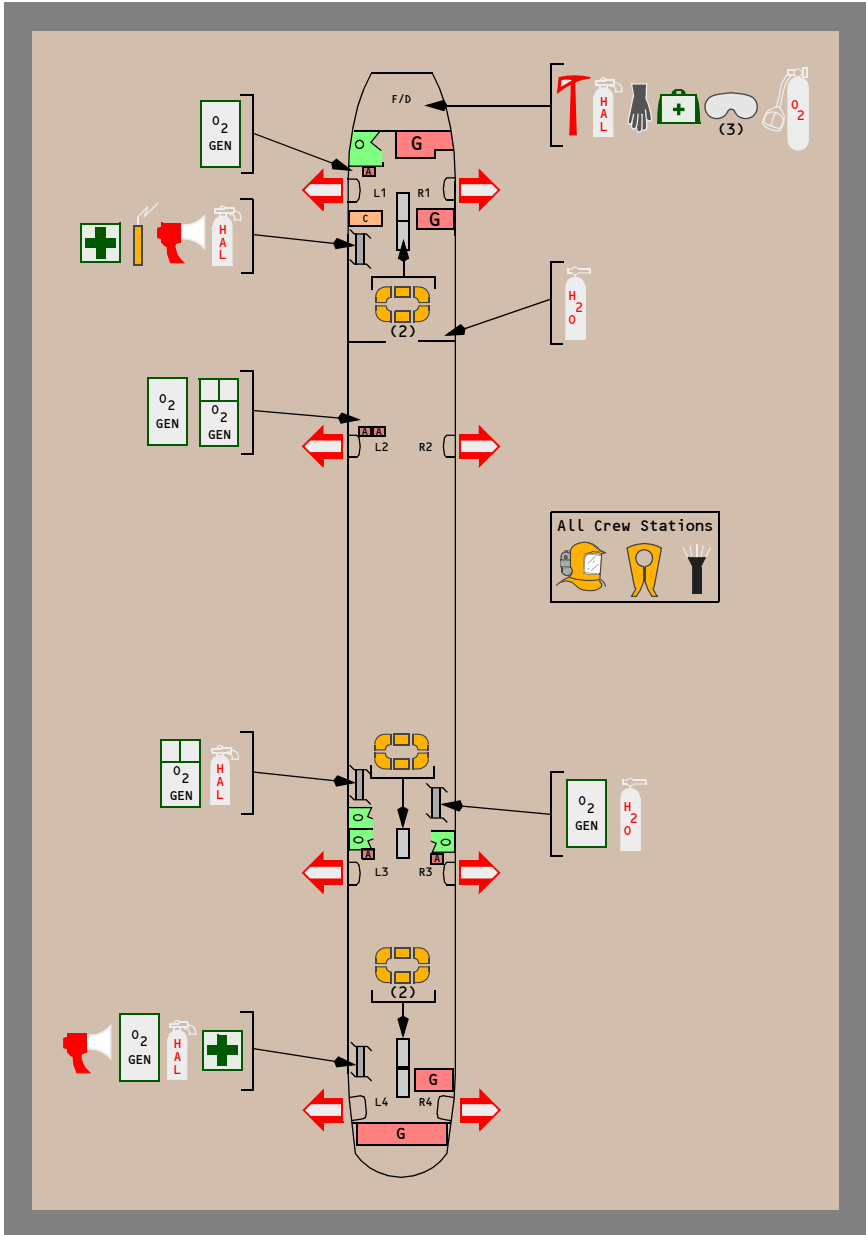

**DO NOT USE FOR FLIGHT** Airplane General, Emergency  
 Equipment, Doors, Windows -  
 757 Flight Crew Operations Manual Emergency Equipment

[Option - 4 emergency over wing door configuration. i.e. (6 entry, 4 overwing doors)]

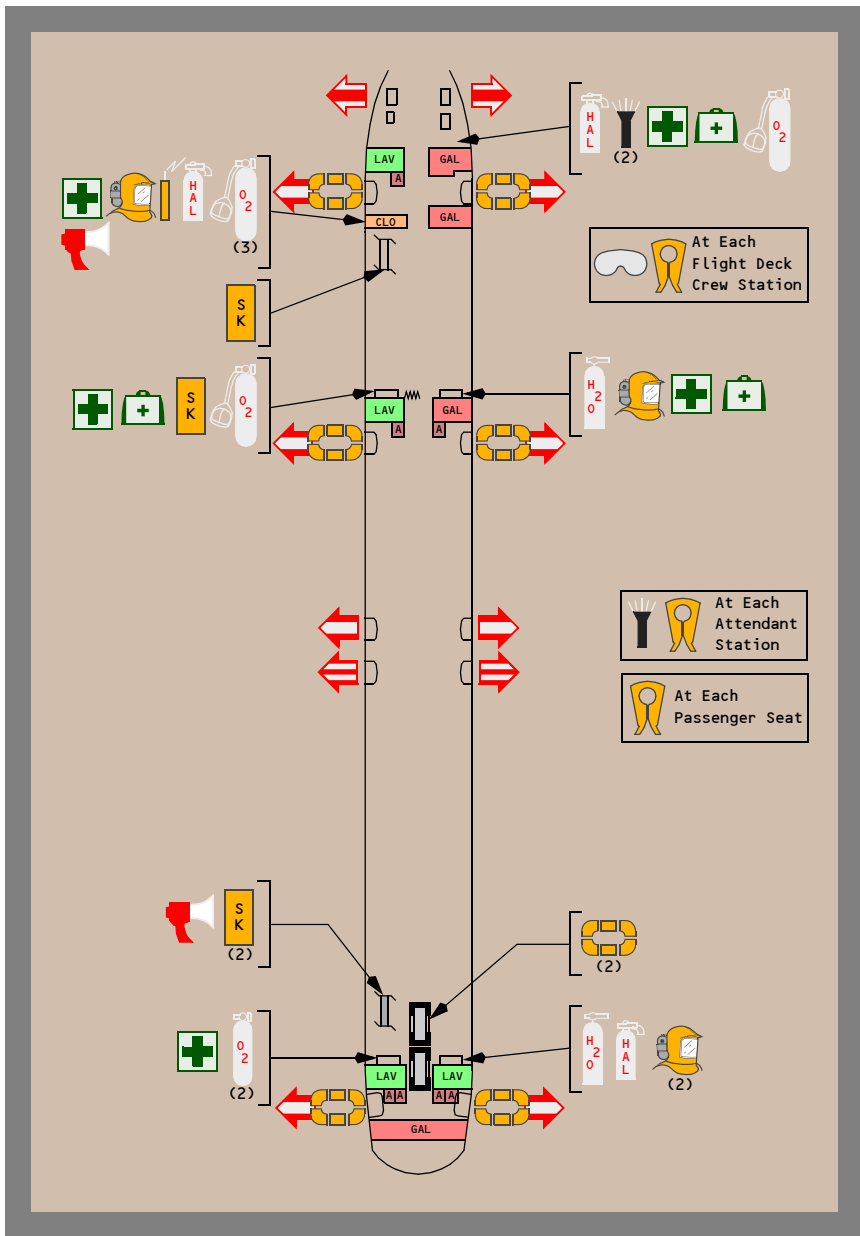

Intentionally  
Blank

**Airplane General, Emergency Equipment, Doors, Windows  
EICAS Messages**

The following EICAS messages may be displayed.

**Access Doors**

Message	Level	Light	Aural	Condition
ACCESS DOORS	Advisory	ACCESS DOORS		Forward equipment bay and electrical equipment compartment access doors are not closed, latched, and locked.
E/E ACCESS DOOR	Advisory	ACCESS DOORS		Electrical equipment access door is not closed, latched, and locked.
FWD ACCESS DOOR	Advisory	ACCESS DOORS		The forward equipment bay access door is not closed, latched, and locked.

**Cargo Doors**

Message	Level	Light	Aural	Condition
CARGO DOORS	Advisory	CARGO DOORS		Cargo doors are not closed, latched, and locked.
AFT CARGO DOOR	Advisory	CARGO DOORS		Cargo door is not closed, latched, and locked.
FWD CARGO DOOR	Advisory	CARGO DOORS		Cargo door is not closed, latched, and locked.

## Entry Doors

Message	Level	Light	Aural	Condition
L ENTRY DOORS R ENTRY DOORS	Advisory	ENTRY DOORS		Two or more entry doors on the same side are not closed, latched, and locked.
L AFT ENT DOOR R AFT ENT DOOR L CTR ENT DOOR R CTR ENT DOOR L FWD ENT DOOR R FWD ENT DOOR	Advisory	ENTRY DOORS		Entry door is not closed, latched, and locked.

## Emergency Exit Doors

### [Option - Aircraft with Emergency Exit Doors]

Message	Level	Light	Aural	Condition
EMER DOORS	Advisory	EMER DOORS		Both emergency doors are not closed, latched, and locked.
L EMER DOOR R EMER DOOR	Advisory	EMER DOORS		Emergency door is not closed, latched, and locked.

## Overwing Emergency Exit

### [Option - Aircraft with Overwing Emergency Exits]

Message	Level	Light	Aural	Condition
EMER DOORS	Advisory	EMER DOORS		Two or more emergency doors are not closed, latched, and locked  (overwing exit door or wing slide compartment door)
L AFT EMER DOOR R AFT EMER DOOR L FWD EMER DOOR R FWD EMER DOOR	Advisory	EMER DOORS		An overwing emergency exit door is not closed, latched, and locked.
L WING SLIDE R WING SLIDE	Advisory	EMER DOORS		Wing slide compartment door is not closed, latched, and locked.

## Emergency Lights

Message	Level	Light	Aural	Condition
EMER LIGHTS	Advisory	UN-ARMED		The emergency lights switch is not in the ARMED position.

## Oxygen System

Message	Level	Light	Aural	Condition
PASS OXYGEN ON	Advisory	ON		Passenger oxygen system is activated.

Intentionally  
Blank



<b>Controls and Indicators</b> .....	<b>2.10</b>
Air Conditioning System .....	2.10.1
Air Conditioning Control Panel .....	2.10.1
Shoulder and Foot Heaters .....	2.10.3
Equipment Cooling Panel .....	2.10.4
Pressurization System .....	2.10.5
Cabin Altitude Controls .....	2.10.5
Cabin Altitude Indicators .....	2.10.6
Bleed Air System .....	2.10.8
Bleed Air Control Panel .....	2.10.8
<b>Air Conditioning System Description</b> .....	<b>2.20</b>
Introduction .....	2.20.1
Air Conditioning Packs .....	2.20.1
Air Conditioning Automatic Mode .....	2.20.1
Air Conditioning Standby Mode .....	2.20.1
Ground Conditioned Air Operation .....	2.20.2
Pack Non–Normal Operation .....	2.20.2
Air Distribution .....	2.20.2
Temperature Control .....	2.20.3
Temperature Control With Loss of Trim Air System .....	2.20.3
Shoulder and Foot Heaters .....	2.20.3
Forward Equipment Cooling System .....	2.20.3
Equipment Smoke .....	2.20.4
Cargo Heat System .....	2.20.4
Air Conditioning System Schematic .....	2.20.5
<b>Pressurization System Description</b> .....	<b>2.30</b>
Introduction .....	2.30.1
Pressurization System Automatic Operation .....	2.30.1
Non–Normal Indications .....	2.30.2

---

<b>Bleed Air System Description</b> .....	<b>2.40</b>
Introduction .....	2.40.1
Engine Bleed Air Supply .....	2.40.1
APU Bleed Air Supply .....	2.40.1
Ground Pneumatic Air Supply .....	2.40.2
Bleed Air Duct System .....	2.40.2
Bleed Air System Schematic .....	2.40.3
<b>EICAS Messages</b> .....	<b>2.50</b>
Air Systems EICAS Messages .....	2.50.1

**Air Conditioning System**

**Air Conditioning Control Panel**

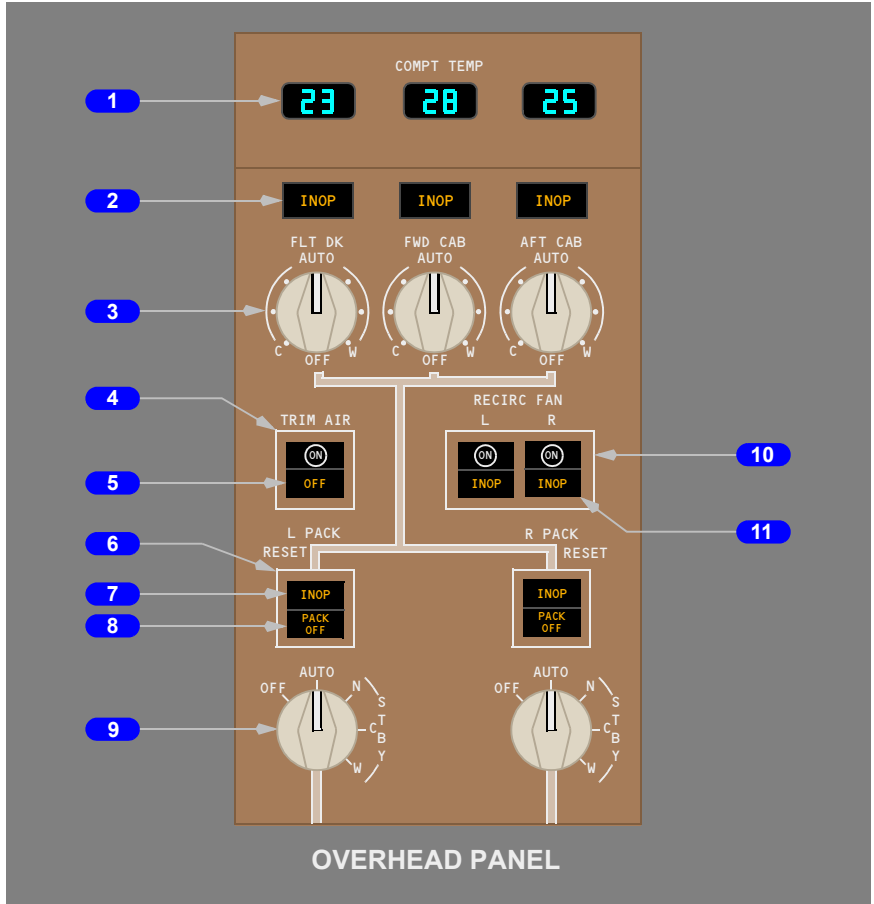

**1 Compartment Temperature (COMPT TEMP) Indicators**

Displays actual temperature sensed in the compartment.

---

**2 Compartment Temperature Inoperative (INOP) Lights**

Illuminated (amber) –

- fault in the zone temperature controller
- the Compartment Temperature Control is OFF
- the trim air switch is OFF.

**3 Compartment Temperature Controls**

AUTO –

- provides automatic compartment temperature control
- rotating the control toward C (cool) or W (warm) sets the desired temperature between 18 degrees C and 30 degrees C.

OFF –

- closes the compartment trim air valve
- the compartment temperature INOP light illuminates.

**4 TRIM AIR Switch**

ON – the trim air valve is commanded open.

Off (ON not visible) – the trim air valve is commanded closed.

**5 Trim Air OFF Light**

Illuminated (amber) – the TRIM AIR switch is off.

**6 PACK RESET Switches**

Push – resets an overheated pack if the pack has cooled to a temperature below the overheat level.

**7 Pack Inoperative (INOP) Lights**

Illuminated (amber) –

- the pack is overheated
- fault in the automatic control system.

**8 PACK OFF Lights**

Illuminated (amber) – the pack valve is closed.

**9 PACK Control Selectors**

OFF – closes the pack valve.

AUTO – the pack is automatically controlled.

STBY–

- N (normal) – regulates the pack outlet temperature to a constant, moderate temperature
- C (cool) – sets the pack to full cold operation
- W (warm) – sets the pack to full warm operation.

#### **10 Recirculation Fan (RECIRC FAN) Switches**

- ON – the recirculation fan operates
- Off (ON not visible) – the recirculation fan does not operate.

#### **11 Recirculation Fan Inoperative (INOP) Lights**

Illuminated (amber) –

- the recirculation fan is failed or not operating
- the RECIRC FAN switch is off.

### **Shoulder and Foot Heaters**

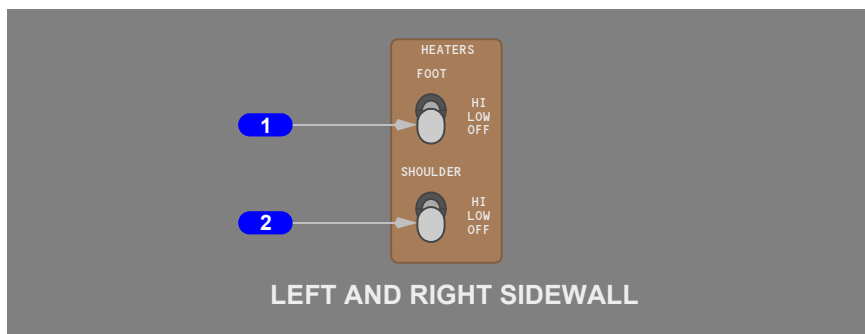

#### **1 FOOT HEATERS Switch**

- HIGH – the under–floor electric heater operates on high setting (in flight only).
- LOW – the under–floor electric heater operates on low setting.
- OFF – the under–floor electric heater is not operating.

#### **2 SHOULDER HEATERS Switch**

- HIGH – the electric heater adds heat at high setting to the conditioned air flowing at shoulder level (in flight only).
- LOW – the electric heater adds heat at low setting to the conditioned air flowing at shoulder level.
- OFF – the electric heater is not operating (no heat added to the conditioned air flowing at shoulder level.).

## Equipment Cooling Panel

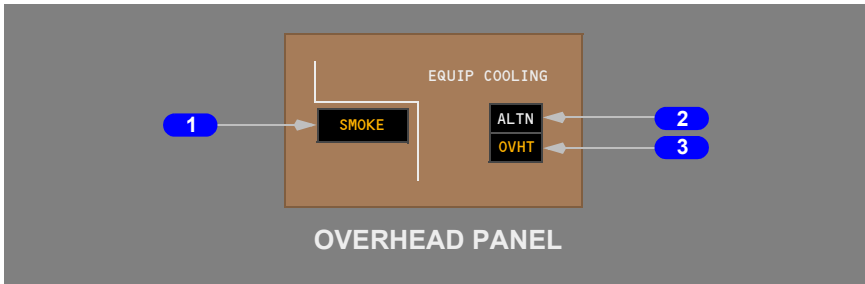

### 1 Equipment Cooling SMOKE Light

Illuminated (amber) – smoke is detected in the forward equipment cooling ducts.

### 2 Alternate (ALTN) Equipment Cooling Switch

ALTN –

- activates the alternate supply fan
- activates the auxiliary fan, if the alternate supply fan fails.

### 3 Equipment Cooling Overheat (OVHT) Light

Illuminated (amber) –

- insufficient airflow (on the ground)
- the supply fan is inoperative
- the alternate supply fan is inoperative.

## Pressurization System

### Cabin Altitude Controls

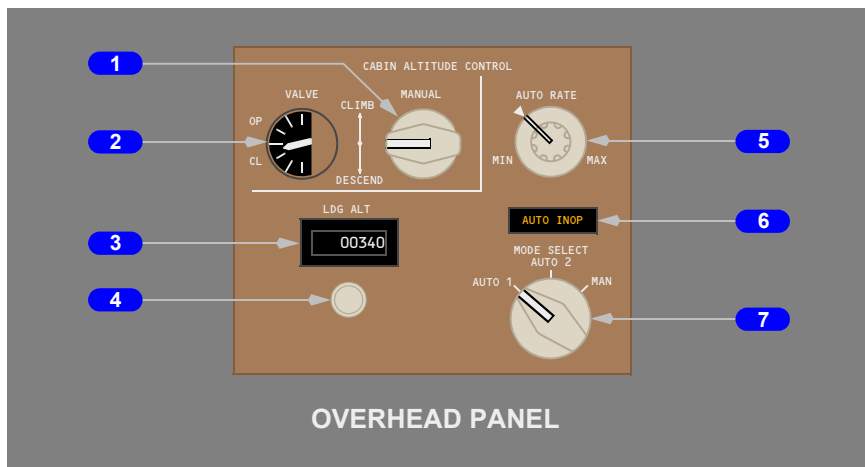

#### 1 Cabin Altitude MANUAL Control

Spring – loaded to center.

Controls cabin outflow valve position with the Cabin Altitude Mode Selector in manual (MAN) mode.

CLIMB – moves outflow valve toward open.

DESCEND – moves outflow valve toward closed.

#### 2 Outflow VALVE Position Indicator

OP – Open.

CL – Closed

#### 3 Landing Altitude (LDG ALT) Indicator

Feet.

Displays selected landing altitude.

#### 4 Landing Altitude (LDG ALT) Selector

Rotate – sets landing altitude indicator.

**5 Cabin Altitude AUTO RATE Control**

Rotate –

- sets limit for cabin altitude rate of climb or descent during auto control
- index mark establishes approximately 500 fpm climb and 300 fpm descent.

**6 AUTO Inoperative (INOP) Light**

Illuminated (amber) –

- AUTO 1 and AUTO 2 cabin altitude control functions are inoperative
- MAN mode is selected.

**7 Cabin Altitude MODE SELECTOR**

Auto 1 –

- activates Auto 1 cabin altitude control for automatic operation
- outflow valve positioned automatically.

Auto 2 –

- activates Auto 2 cabin altitude control for automatic operation
- outflow valve positioned automatically.

MAN (Manual) –

- outflow valve position is controlled by the cabin altitude MANUAL control
- AUTO INOP light illuminates.

**Cabin Altitude Indicators**

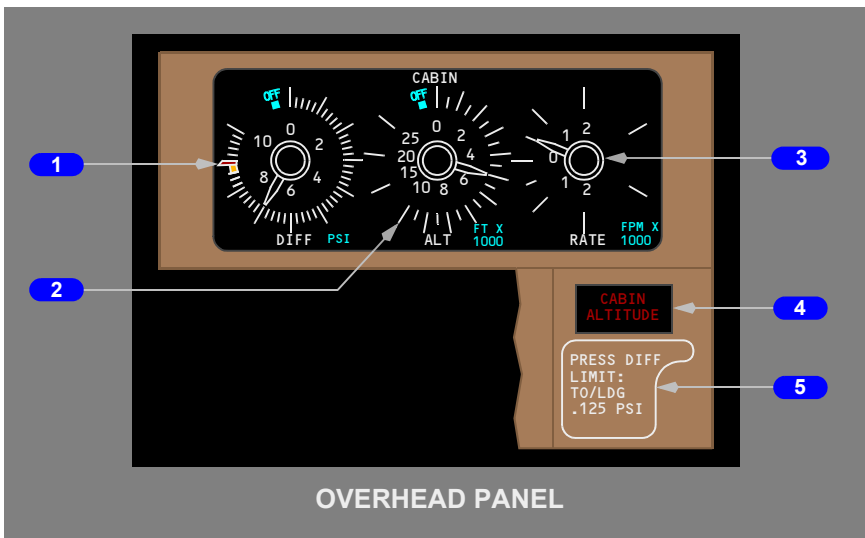



**1 Cabin Differential Pressure Indicator**

Pounds per square inch (psi).

**2 Cabin Altitude**

Feet x 1,000.

**3 Cabin Altitude Rate**

Feet per minute (fpm x 1,000).

**4 Cabin Altitude Light**

Illuminated (red) –

- cabin altitude exceeds 10,000 feet
- extinguishes when cabin altitude descends below 8,500 feet.

**5 Pressure Differential (PRESS DIFF) Limit Placard**

Specifies differential pressure limitation for takeoff and landing.

**Cabin Altitude (CABIN ALT) Light**

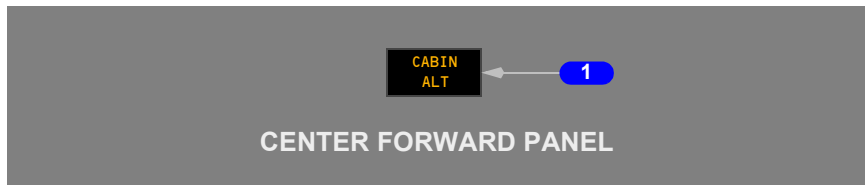

**1 Cabin Altitude Light**

Illuminated (red) –

- cabin altitude exceeds 10,000 feet
- extinguishes when cabin altitude descends below 8,500 feet.

## Bleed Air System

### Bleed Air Control Panel

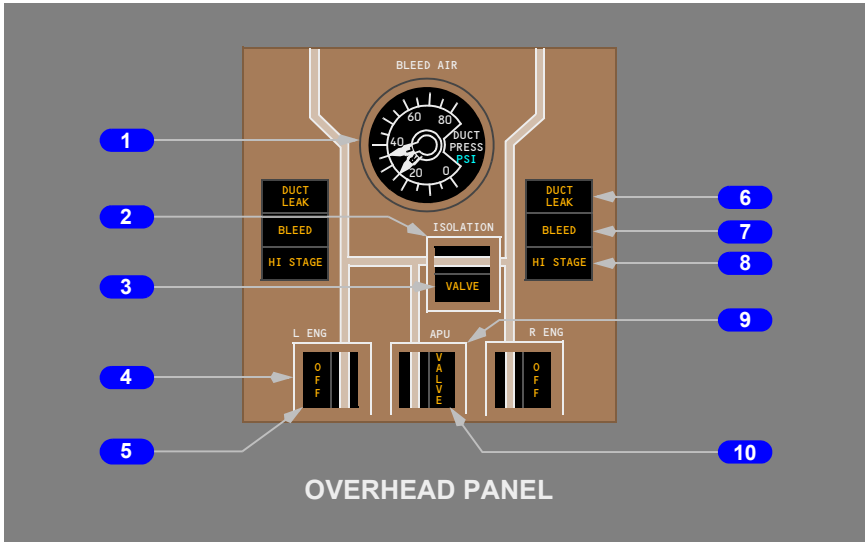

**1 Duct Pressure (DUCT PRESS) Indicators**

Pounds per square inch (psi).

**2 ISOLATION Switch**

On (bar in view) – commands isolation valve to open.

Off (bar not visible) – commands isolation valve to close.

**3 Isolation VALVE Light**

Illuminated (amber) – isolation valve position disagrees with commanded position.

**4 Engine (ENG) Bleed Air Switches**

On (bar in view) – the engine bleed air valve opens when engine bleed air is available.

Off (bar not visible) – valve is manually commanded closed.

---

**5 Engine Bleed Air OFF Lights**

Illuminated (amber) – engine bleed air valve is closed:

- automatically due to a system fault
- the switch is OFF
- the engine is not running.

**6 DUCT LEAK Lights**

Illuminated (amber) – a high temperature bleed air leak is detected.

**7 Engine BLEED Lights**

Illuminated (amber) – the engine bleed air temperature is excessive.

**8 Engine High Stage (HI STAGE) Lights**

Illuminated (amber) –

- the engine bleed system pressure is excessive
- the engine high pressure bleed air valve is automatically locked closed.

**9 APU Bleed Air Switch**

On (bar in view) – the APU bleed air valve is automatically controlled

Off (bar not visible) – commands APU bleed air valve to close.

**10 APU Bleed Air VALVE Light**

Illuminated (amber) – APU bleed air valve position disagrees with commanded position.

Intentionally  
Blank

---

**Introduction**

The air conditioning system supplies conditioned bleed air and recirculated cabin air at a controlled temperature throughout the airplane.

The system supplies conditioned air to the flight deck shoulder heaters.

The system supplies ventilation for the cabin:

- lavatories
- galleys
- individual passenger seat gaspers.

Pack control, zone temperature control, cabin air recirculation, fault detection, and overheat protection are all automatic.

The airplane is divided into three temperature zones: the flight deck and two cabin zones.

---

**Air Conditioning Packs**

Two identical air conditioning packs cool bleed air from the engines, APU, or high pressure air from a ground source. Bleed air is precooled before entering the pack. The packs are controlled by two identical pack controllers. Pack output is automatically increased during high pack demand periods (to compensate for a failed pack or recirculation fan), or limited during high bleed air demand periods (such as with an engine inoperative).

**Air Conditioning Automatic Mode**

With the pack selector in the AUTO position, pack output temperature is determined by the cabin temperature controller. Zone temperature is then satisfied by the zone temperature controllers using trim air.

**Air Conditioning Standby Mode**

With the pack selector in the standby mode, pack output temperature is determined by the position of the pack selector:

- N (normal) – constant, moderate temperature
- C (cool) – full cold
- W (warm) – full warm.

---

## Ground Conditioned Air Operation

When a ground source of conditioned air is available, it may be used to supply conditioned air directly to the cabin distribution system, eliminating the need for pack operation.

### Pack Non–Normal Operation

Pack control, fault detection, and overheat protection are all automatic.

The pack INOP light illuminates and the EICAS advisory message L or R PACK TEMP displays for all pack control system faults and overheats.

When an automatic control system fault or a pack outlet overheat is detected, the pack continues to operate in an uncontrolled, degraded condition, requiring crew interaction.

The pack valve closes and the pack is shut down automatically when an internal pack overheat is detected. The PACK OFF light illuminates and the EICAS advisory message L or R PACK OFF displays in addition to the PACK TEMP indications.

If the INOP light remains illuminated after selecting STBY, the fault is a pack overheat. After the pack has cooled, an attempt to restore pack operation may be made by pushing the PACK RESET switch.

---

## Air Distribution

Conditioned air from the packs flows into a mix manifold where it mixes with air from two recirculation fans. Recirculation fans maintain overall cabin air circulation while allowing a reduction of cabin air ventilation, permitting the packs to be operated at a reduced flow. The mixed air is then ducted into the cabin.

The flight deck receives 100% fresh conditioned air from the left pack only and is maintained at a slightly higher pressure than the passenger cabin. This prevents smoke from entering the flight deck. When the left pack is inoperative, the flight deck receives air from the mix manifold.

The left recirculation fan draws air through the forward E/E system and returns it to the mix manifold. Air that moves from the cabin to the lower deck either exhausts overboard through the outflow valve or is drawn into the right recirculation fan and returns to the mix manifold.

The right recirculation fan can be turned off for several minutes to provide a more rapid exchange of air. The left recirculation fan should not be turned off as this causes the overboard exhaust valve to open. Maintenance action is required to reset the OVBD EX VAL OPEN status message.

---

The recirculation fan INOP light illuminates and the EICAS advisory message L or R RECIR FAN displays whenever a recirculation fan fails or the switch is off. A slight increase in fuel consumption occurs for each fan that is off.

---

## Temperature Control

The airplane is divided into three temperature control compartments:

- flight deck
- forward cabin
- aft cabin

The pack controllers regulate the pack output air temperature to satisfy the temperature requirement of the compartment requiring the coolest air. Hot trim air from the bleed air system is added through trim air valves to control the temperature in each of the other compartments. Each temperature control compartment has an associated temperature control.

A compartment INOP light illuminates and the EICAS advisory message FLT DECK TEMP, FWD CABIN TEMP, or AFT CABIN TEMP displays to indicate:

- zone temperature controller failure
- zone selector is in the OFF position
- trim air switch is OFF

## Temperature Control With Loss of Trim Air System

During operation with the trim air system off, the packs attempt to maintain all compartments at an average temperature. The trim air OFF light illuminates and the EICAS advisory message TRIM AIR displays when a TRIM AIR switch is off.

---

## Shoulder and Foot Heaters

Flight crew shoulder heat is provided by electric heaters in the ducts that supply conditioned air to the side windows. Foot heat is provided by electric heating elements only, with no airflow. The high setting for both shoulder and foot heat is available in flight only.

---

## Forward Equipment Cooling System

Forward equipment cooling supplies cooling air to the equipment in the forward equipment racks and the flight deck avionics. The system has a supply fan that draws cooling air from the cabin and forces it through the equipment racks and avionics. The air is then exhausted into the air conditioning mix manifold by the left recirculation fan. If the differential pressure is low, the overboard exhaust valve automatically opens and most of the air is exhausted overboard.

---

---

An auxiliary fan automatically operates to provide cooling for essential avionics and electrical equipment if the alternate supply fan has been selected but both supply fans are inoperative. However, non-essential avionics and electrical equipment are subject to imminent failure. The auxiliary fan can be powered by the hydraulic driven generator.

On the ground, the OVHT light illuminates, the EQPT OVHT message displays and the ground crew call horn sounds if insufficient cooling airflow is detected.

---

## Equipment Smoke

The equipment cooling SMOKE light illuminates and the EICAS advisory message FWD EQPT SMOKE displays when smoke is detected in the equipment cooling system.

The following items, which may be observed in the flight deck, occur automatically to help evacuate the smoke:

- one or both recirculation fans turn off
- one or both air conditioning packs switch to high flow
- the overboard exhaust valve opens

When smoke is no longer detected, the recirculation fans and air conditioning packs automatically return to normal operation.

---

## Cargo Heat System

Cargo compartment heating and ventilation is completely automatic. There are no controls or indicators in the cockpit.



**Air Conditioning System Schematic**

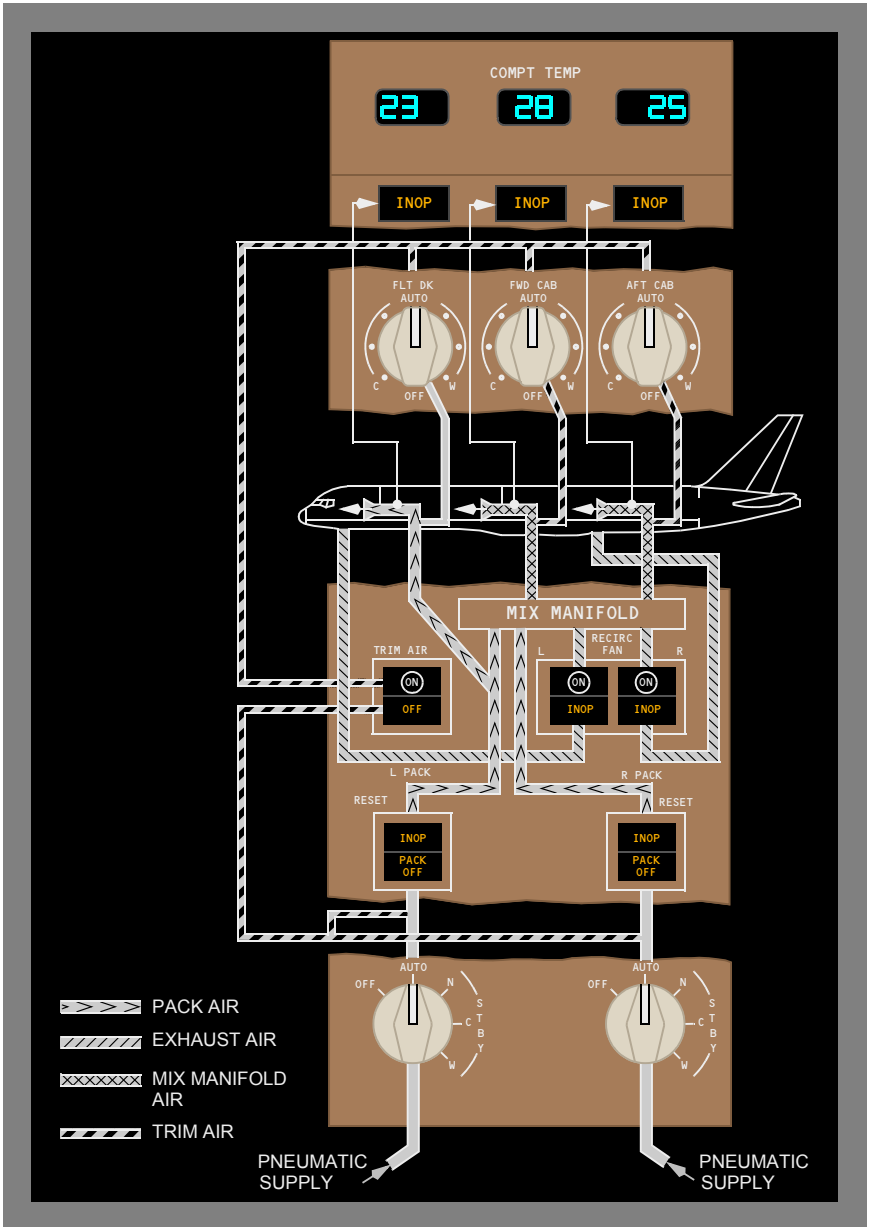

Intentionally  
Blank

**Introduction**

Cabin pressurization is controlled by adjusting the discharge of conditioned cabin air through the outflow valve.

Positive pressure relief valves and negative pressure relief valves protect the fuselage against excessive pressure differential.

The pressurization system has automatic and manual operating modes.

**Pressurization System Automatic Operation**

The pressurization system is in the automatic mode when the cabin altitude mode selector is set to AUTO 1 or AUTO 2. If the selected auto mode fails, control is automatically switched to the other auto mode.

In the automatic mode, the pressurization system uses ambient pressure data from the air data system in conjunction with the selected cabin auto rate, the takeoff altitude and the indicated landing altitude to calculate the cabin pressurization schedule.

**Takeoff**

For takeoff, the system supplies a small positive pressurization to cause a smooth cabin altitude transition.

**Climb**

During climb, cabin altitude increases on a schedule related to the takeoff field elevation, airplane altitude, and the selected auto climb rate limit.

If the maximum cabin pressure differential is reached, cabin climb rate becomes a function of airplane climb rate, while maintaining the maximum differential pressure.

**Cruise**

Shortly after the airplane levels off, the system enters the cruise mode. The landing altitude and the scheduled cabin altitude are compared and the higher of these two is selected for the cruise cabin altitude. If necessary, the cabin climbs to the cruise cabin altitude at one-half the auto rate or descends to the cruise cabin altitude at the auto rate.

The cruise cabin altitude does not change for minor altitude variations. A significant altitude change causes the system to re-enter the climb mode or to enter the descent mode.

---

## Descent and Landing

During descent, cabin altitude decreases to slightly below the selected landing altitude. This ensures that the airplane lands pressurized. Landing altitude barometric pressure correction comes from the captain's altimeter.

At touchdown, the outflow valve opens to depressurize the airplane.

---

## Non-Normal Indications

If the cabin altitude climbs above 10,000 feet, the CABIN ALT and CABIN ALTITUDE lights illuminate and the EICAS warning message CABIN ALTITUDE displays. The lights extinguish and the EICAS message blanks when the cabin altitude descends below 8,500 feet.

The AUTO INOP light illuminates and the EICAS caution message CABIN AUTO INOP displays when automatic pressurization control fails or when cabin altitude MODE SELECT is MAN. Manual operation is needed if the AUTO INOP light illuminates and the EICAS caution message CABIN AUTO INOP displays. Positive pressure relief valves and negative pressure relief valves operate independently from the pressurization control system to protect the fuselage against excessive pressure differential.

Only the automatic mode is equipped with an aneroid switch that automatically closes the outflow valve when the cabin altitude exceeds 11,000 feet. The manual mode has no auto closure feature.

To operate the pressurization system manually:

- set the cabin altitude MODE SELECT to MAN
- hold the cabin altitude MANUAL control to CLIMB to move the outflow valve toward open and cause the cabin altitude to climb
- hold the cabin altitude MANUAL control to DESCEND to move the outflow valve toward closed and cause the cabin altitude to descend.

---

**Introduction**

Bleed air can be supplied by the engines, APU, or a ground air source.

Bleed air is used for:

- air conditioning
- pressurization
- engine start
- wing and engine anti-ice
- hydraulic reservoir pressurization.

---

**Engine Bleed Air Supply**

Engine bleed air comes from either the high pressure (HP) or the low pressure (LP) engine compressor sections. LP air is used during high power setting operations. HP air is used during descent and other low power setting operations.

The engine bleed air valves are armed when the engine bleed air switches are selected ON. The valves are pressure actuated and remain closed until engine bleed air pressure is sufficient to cause forward flow. The valves may close when the APU is starting either engine. The valves may close when ground pneumatic air is connected or during periods of low engine bleed air demand, such as when the air conditioning packs are OFF. The engine bleed air OFF light illuminates and the EICAS advisory message L or R ENG BLEED OFF displays when the engine bleed air valve is closed.

The HI STAGE light illuminates and the EICAS advisory message L or R ENG HI STAGE displays when engine bleed air pressure is excessive and the high pressure bleed air valve automatically locks closed. Low pressure air continues to flow to the affected side.

The engine BLEED light illuminates and the EICAS Caution message L or R ENG BLEED VAL displays if the engine bleed air temperature is excessive.

---

**APU Bleed Air Supply**

APU bleed air is used primarily during ground operations for air conditioning pack operation and engine starting. In flight, APU bleed air is available up to approximately 17,000 feet.

The check valve in the APU supply line prevents reverse flow of bleed air from the duct into the APU.

The APU bleed air VALVE light illuminates and the EICAS advisory message APU BLEED VAL displays when the APU Bleed Valve position disagrees with the commanded position.

## Ground Pneumatic Air Supply

External connectors are provided to connect a ground source of high pressure air directly to the bleed air duct.

Check valves prevent reverse flow of bleed air from the bleed air duct to the connectors.

---

## Bleed Air Duct System

The duct pressure indicator displays the pressure in the left and right bleed air ducts.

The isolation valve separates the bleed air ducts into isolated segments. The isolation valve is normally closed except for engine start or single bleed source operation.

The isolation VALVE light illuminates and the EICAS advisory message BLEED ISLN VAL displays when the isolation valve position disagrees with the commanded position.

The DUCT LEAK light illuminates and the EICAS caution message L or R BLD DUCT LEAK displays when a high temperature bleed air leak is detected.

## Bleed Air System Schematic

When equipped with Pratt and Whitney engines.

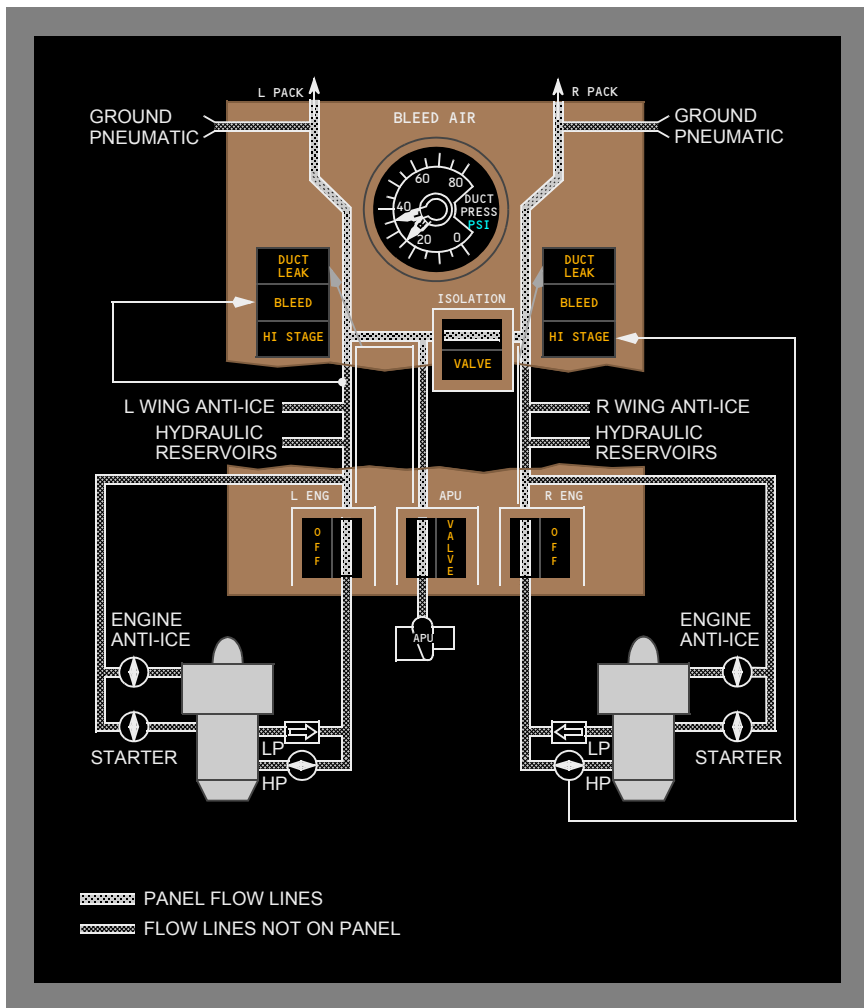

When equipped with Rolls Royce engines.

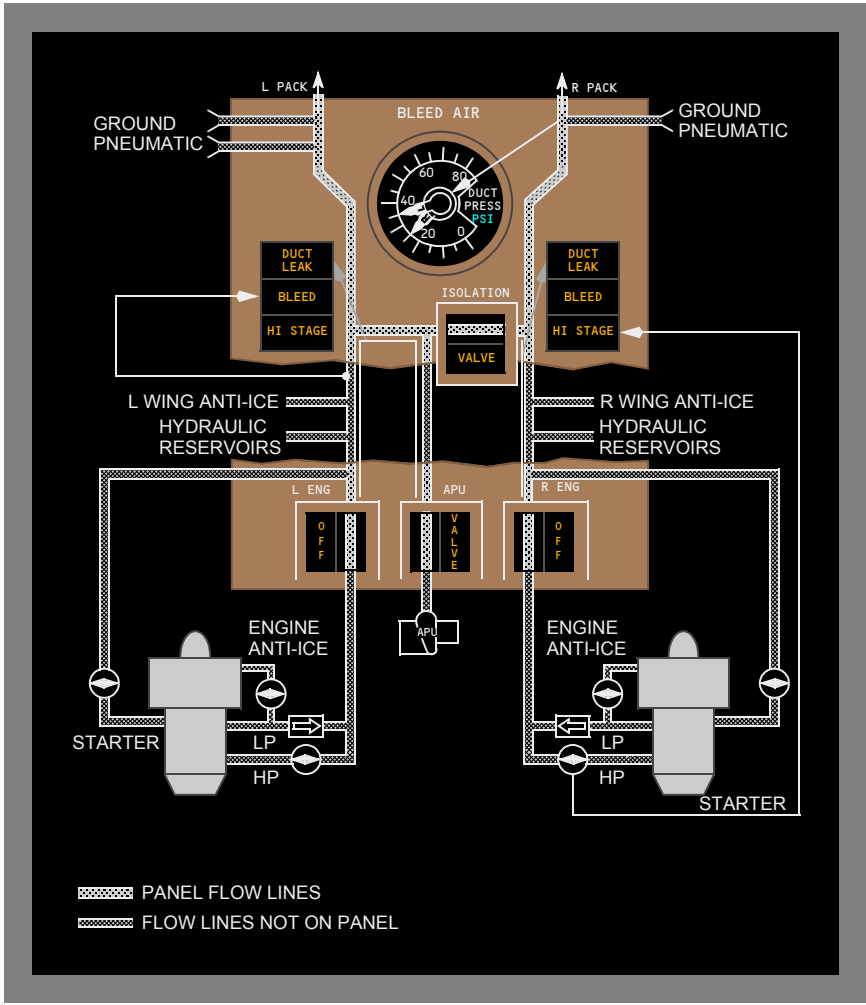



**Air Systems EICAS Messages**

The following EICAS messages can be displayed.

Message	Level	Light	Aural	Condition
APU BLEED VAL	Advisory	VALVE		APU bleed valve position disagrees with the commanded position.
L BLD DUCT LEAK R BLD DUCT LEAK	Caution	DUCT LEAK	Beeper	A high temperature bleed air leak is detected.
BLEED ISLN VAL	Advisory	VALVE		Bleed isolation valve position disagrees with the commanded position.
CABIN ALTITUDE	Warning	CABIN ALTITUDE, CABIN ALT	Siren	Cabin altitude excessive.
CABIN AUTO INOP	Caution	AUTO INOP	Beeper	Automatic pressurization control has failed or the cabin altitude mode selector is in manual.
AFT CABIN TEMP FWD CABIN TEMP	Advisory	INOP		A fault in the zone temperature controller, compartment temperature control is in the OFF position, or trim air switch OFF.
L ENG BLEED OFF R ENG BLEED OFF	Advisory	OFF		Engine bleed air valve is closed for a system fault.
L ENG BLEED VAL R ENG BLEED VAL	Caution	BLEED	Beeper	Engine bleed air temperature excessive.
L ENG HI STAGE R ENG HI STAGE	Advisory	HI STAGE		Engine bleed system pressure is excessive and the high pressure bleed air valve has automatically locked closed.

**DO NOT USE FOR FLIGHT**  
**757 Flight Crew Operations Manual**

Message	Level	Light	Aural	Condition
EQPT OVHT	Advisory	OVHT		Forward equipment cooling system inoperative.
FWD EQPT SMOKE	Advisory	SMOKE		Smoke detected in the forward equipment cooling ducts.
FLT DECK TEMP	Advisory	INOP		Duct overheat, fault in the zone temperature controller, or trim air switch off.
L PACK OFF R PACK OFF	Advisory	PACK OFF		Pack valve is closed.
L PACK TEMP R PACK TEMP	Advisory	INOP		Automatic control system fault or overheat.
L RECIR FAN R RECIR FAN	Advisory	INOP		Fan is failed or not operating.
TRIM AIR	Advisory	OFF		Trim air switch off.

**Controls and Indicators . . . . . 3.10**

    Anti-Ice Panel . . . . . 3.10.1

    Window Heat and Wiper Panels . . . . . 3.10.2

        Window Heat Panel . . . . . 3.10.2

        Wiper Panel . . . . . 3.10.2

        Probe Heat Lights . . . . . 3.10.3

**System Description . . . . . 3.20**

    Introduction . . . . . 3.20.1

    Engine Anti-Ice System. . . . . 3.20.1

        Engine Anti-Ice System Operation . . . . . 3.20.1

    Wing Anti-Ice System. . . . . 3.20.1

        Wing Anti-Ice System Operation. . . . . 3.20.1

    Anti-Ice System Schematic . . . . . 3.20.2

    Flight Deck Window Heat . . . . . 3.20.3

    Windshield Wipers. . . . . 3.20.4

    Probe Heat . . . . . 3.20.4

**EICAS Messages. . . . . 3.30**

    Anti-Ice EICAS Messages. . . . . 3.30.1

Intentionally  
Blank

#### Anti-Ice Panel

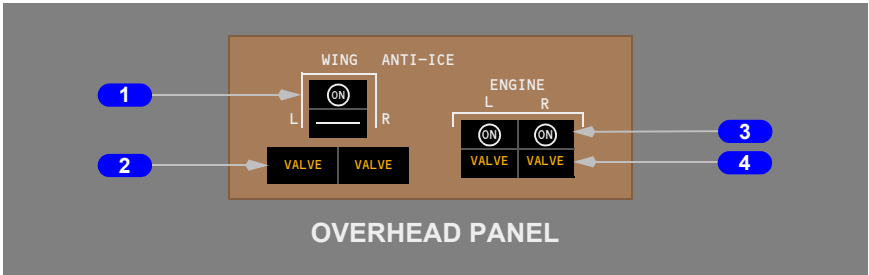

#### **1** WING ANTI-ICE Switch

ON – in flight, both wing anti-ice valves are commanded open.

Off (ON not visible) – both wing anti-ice valves are commanded closed.

#### **2** Wing Anti-Ice VALVE Lights

Illuminated (amber) – wing anti-ice valve position disagrees with the switch position.

#### **3** ENGINE ANTI-ICE Switches

ON – the engine anti-ice valve is commanded open.

Off (ON not visible) – the engine anti-ice valve is commanded closed.

#### **4** Engine Anti-Ice VALVE Lights

Illuminated (amber) – engine anti-ice valve position disagrees with the switch position.

## Window Heat and Wiper Panels

### Window Heat Panel

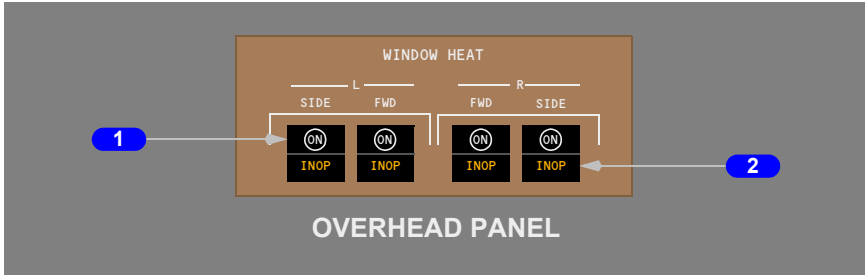

#### 1 WINDOW HEAT Switches

ON – window heat is applied to the selected windows.

Off (ON not visible) – window heat is removed from the selected windows

#### 2 Window Heat Inoperative (INOP) Lights

Illuminated (amber) – the window is not being heated.

### Wiper Panel

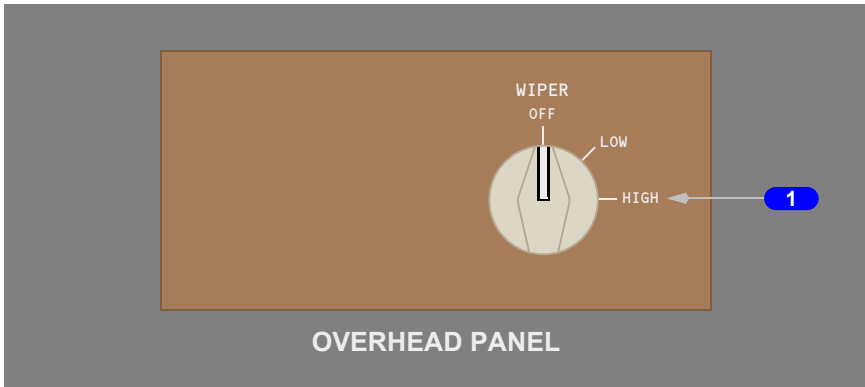

#### 1 WIPER Selector

OFF – the wipers are stowed at the base of the windows.

LOW – the wipers operate at low speed.

HIGH – the wipers operate at high speed.

## Probe Heat Lights

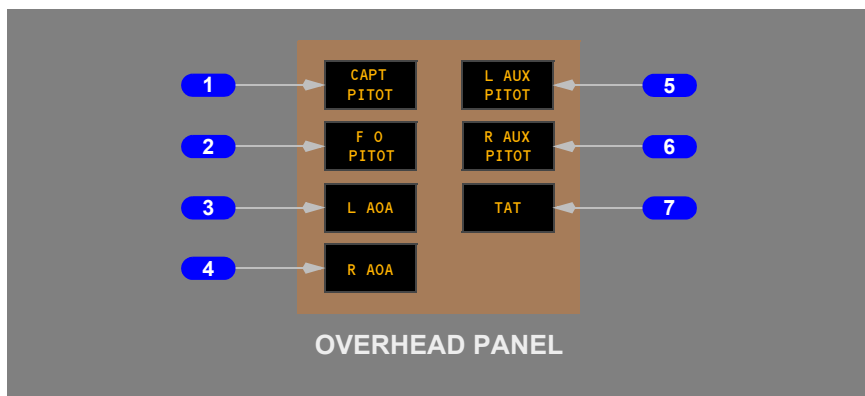

### **1** Captain Pitot (CAPT PITOT) Light

Illuminated (amber) – probe is not being heated in flight or neither engine is running on the ground.

### **2** First Officer Pitot (FO PITOT) Light

Illuminated (amber) – probe is not being heated in flight or neither engine is running on the ground.

### **3** Left Angle of Attack (L AOA) Probe Light

Illuminated (amber) – probe is not being heated in flight or neither engine is running on the ground.

### **4** Right Angle of Attack (R AOA) Probe Light

Illuminated (amber) – probe is not being heated in flight or neither engine is running on the ground.

### **5** Left Auxiliary Pitot (L AUX PITOT) Light

Illuminated (amber) – probe is not being heated in flight or neither engine is running on the ground.

### **6** Right Auxiliary Pitot (R AUX PITOT) Light

Illuminated (amber) – probe is not being heated in flight or neither engine is running on the ground.

**7 Total Air Temperature (TAT) Probe Light**

Illuminated (amber) – probe is not being heated in flight or neither engine is running on the ground.



---

**Introduction**

The anti-ice and rain systems include:

- engine anti-ice
- wing anti-ice
- flight deck window heat
- windshield wipers
- probe heat.

---

**Engine Anti-Ice System**

The engine anti-ice system uses engine bleed air to provide engine cowl inlet ice protection. Engine anti-ice can be operated in flight or on the ground. The left and right engines have identical, independent anti-ice systems. This allows the remaining system to operate if one engine fails.

**Engine Anti-Ice System Operation**

On the ground or in flight, pushing the ENGINE ANTI-ICE switches ON allows engine bleed air to anti-ice the engine cowl inlets. The engine thermal anti-ice (TAI) annunciation appears above the EICAS N1 indication when an engine anti-ice valve is open. The VALVE light illuminates and the EICAS advisory message L or R ENG ANTI-ICE displays when the engine anti-ice valve disagrees with the switch position.

---

**Wing Anti-Ice System**

The wing anti-ice system provides bleed air to three midwing leading edge slats on each wing. Wing anti-ice can be operated in flight only. It is inhibited on the ground.

**Wing Anti-Ice System Operation**

In flight, pushing the WING ANTI-ICE switch ON opens the wing anti-ice valve in each wing, allowing bleed air to flow from the bleed air manifold to the affected slats.

Maximum EPR limits are automatically reduced with the Wing Anti-ice switch in the ON position.

Maximum EPR limits are automatically reduced with the Wing Anti-ice valve in the open position.

The VALVE light illuminates and the EICAS advisory message L or R WING ANTI-ICE displays if the wing anti-ice valve disagrees with the switch position.

### Anti-Ice System Schematic

When equipped with Rolls Royce engines.

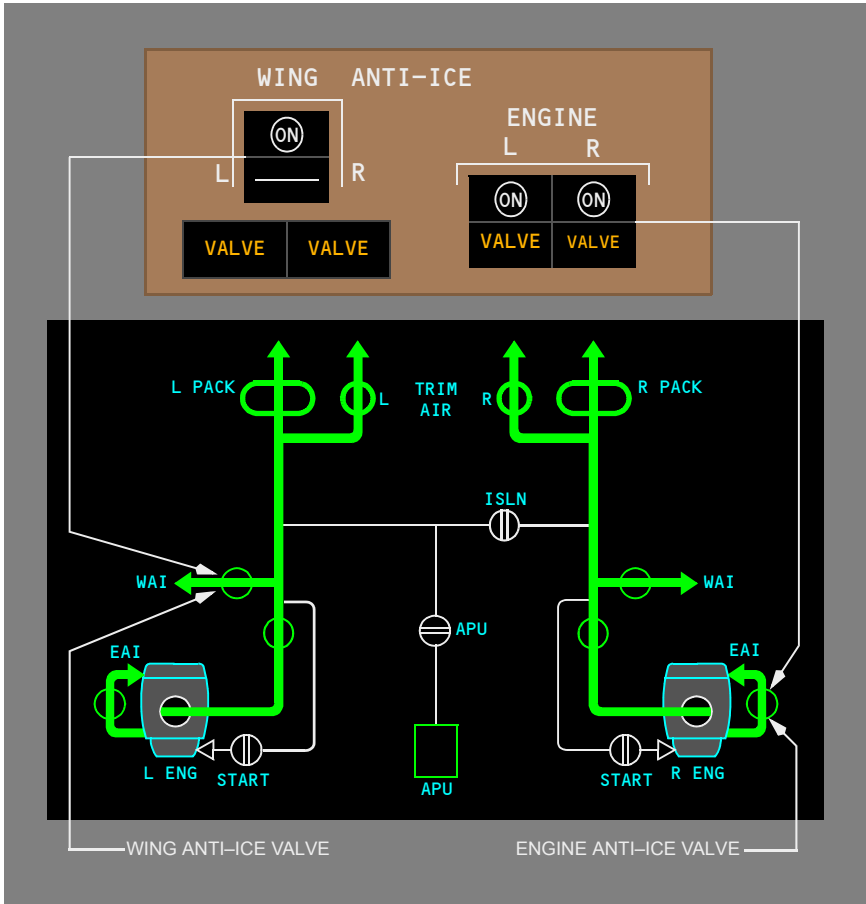

When equipped with Pratt and Whitney engines.

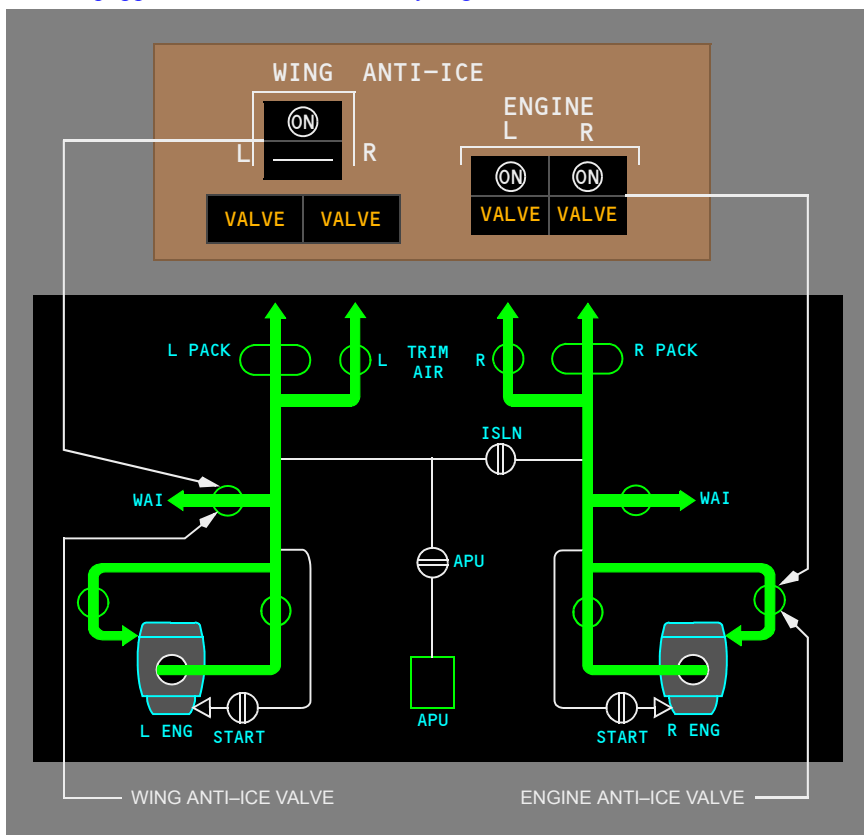

## Flight Deck Window Heat

All flight deck windows are electrically heated. The forward windows have anti-icing protection and anti-fogging. The side windows have anti-fogging protection only.

The WINDOW HEAT switches control heating for all flight deck windows. With the switches ON, window heat operates as soon as electrical power is established. The windows are protected from thermal shock when the switches are initially placed ON.

In addition to the electric heating, conditioned air is ducted to the top of the forward windows and then flows along the inside surface to provide supplemental anti-fogging. The anti-fogging airflow is continuous and is independent of electric window heat.

---

One INOP light illuminates and the EICAS advisory message L or R FWD WINDOW or L or R SIDE WINDOW displays to indicate a window is not being heated. If two or more INOP lights illuminate, the EICAS advisory message WINDOW HEAT displays.

---

## **Windshield Wipers**

The forward windows are equipped with two-speed wipers. With the WIPER selector in the OFF position, the wipers are off and stowed.

---

## **Probe Heat**

Operation of the probe heat system is fully automatic. Power to the electrically heated probes is applied any time an engine is running.

An individual probe heat light illuminates and the associated EICAS advisory message displays when a probe is not being heated. If two or more probe lights illuminate, the EICAS advisory message PROBE HEAT displays.

**Anti-Ice EICAS Messages**

The following EICAS messages can be displayed.

Message	Level	Light	Aural	Condition
L AOA PROBE R AOA PROBE	Advisory	L AOA R AOA		AOA probe heat is inoperative.
L AUX PITOT R AUX PITOT	Advisory	L AUX PITOT R AUX PITOT		Aux pitot probe heat is inoperative.
CAPT PITOT	Advisory	CAPT PITOT		Captain's pitot probe heat is inoperative.
L ENG ANTI-ICE R ENG ANTI-ICE	Advisory	VALVE		Engine anti-ice valve disagrees with switch position.
F/O PITOT	Advisory	F O PITOT		First officer's pitot probe heat is inoperative.
PROBE HEAT	Advisory	Two or more PITOT, AOA or TAT		Two or more probe heats are inoperative.
TAT PROBE	Advisory	TAT		TAT probe heat is inoperative.
L FWD WINDOW R FWD WINDOW	Advisory	INOP		Window is not being heated.
L SIDE WINDOW R SIDE WINDOW	Advisory	INOP		Window is not being heated.
WINDOW HEAT	Advisory	Two or more INOP		Two or more windows are not being heated.
L WING ANTI-ICE R WING ANTI-ICE	Advisory	VALVE		Wing anti-ice valve disagrees with switch position.

Intentionally  
Blank

### Automatic Flight

### Chapter 4

#### Table of Contents

#### Section 0

<b>Controls and Indicators</b> .....	<b>4.10</b>
Mode Control Panel (MCP) .....	4.10.1
Autopilot Flight Director System (AFDS) Controls .....	4.10.1
Autothrottle (A/T) System Controls .....	4.10.3
Autopilot Flight Director IAS/MACH Controls .....	4.10.4
Autopilot Flight Director Roll and Pitch Controls .....	4.10.5
Autopilot Flight Director Heading and Bank Angle Controls ..	4.10.7
Autopilot Flight Director Vertical Speed (V/S) Controls .....	4.10.8
Autopilot Flight Director Altitude Controls .....	4.10.9
Autopilot Flight Director Approach Mode Controls .....	4.10.10
Autoland Status .....	4.10.12
ADI Flight Mode Annunciations (FMAs) .....	4.10.14
Autopilot Disengage Switch .....	4.10.19
Autothrottle Disconnect and Go-Around Switches .....	4.10.20
Autoflight Lights .....	4.10.21
<b>System Description</b> .....	<b>4.20</b>
Introduction .....	4.20.1
Autopilot Flight Director System .....	4.20.1
MCP Switches .....	4.20.1
Autopilot Engagement .....	4.20.2
Autopilot Disengagement .....	4.20.2
AFDS Failures .....	4.20.2
Flight Director Display .....	4.20.3
Autopilot Flight Director System Schematic .....	4.20.4
Autoland Status Annunciators (ASA) .....	4.20.4
AFDS Flight Mode Annunciations .....	4.20.5
Autothrottle System .....	4.20.9
Thrust Management Computer .....	4.20.9
Thrust Mode Select Panel .....	4.20.10
Autothrottle Thrust Lever Operation .....	4.20.10
Autothrottle Disconnect .....	4.20.10

---

Automatic Flight Operations . . . . .	4.20.11
Automatic Flight – Takeoff and Climb Profile . . . . .	4.20.11
Automatic Flight – Cruise . . . . .	4.20.14
Automatic Flight – Approach and Landing . . . . .	4.20.14
Automatic Flight – Approach Profile . . . . .	4.20.16
Automatic Flight – Go-Around . . . . .	4.20.17
Automatic Flight – Windshear Recovery . . . . .	4.20.19
Automatic Flight Limit Modes . . . . .	4.20.19
<b>EICAS Messages . . . . .</b>	<b>4.30</b>
Automatic Flight EICAS Messages . . . . .	4.30.1



#### Mode Control Panel (MCP)

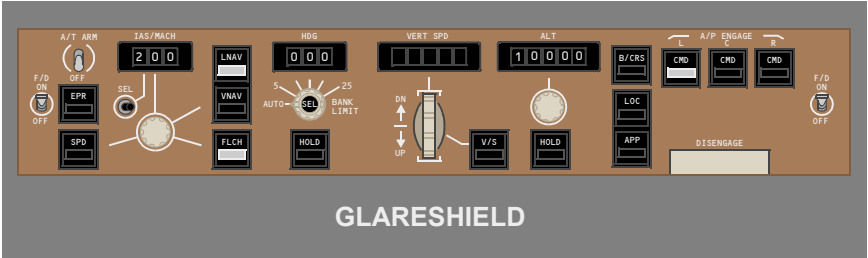

#### Autopilot Flight Director System (AFDS) Controls

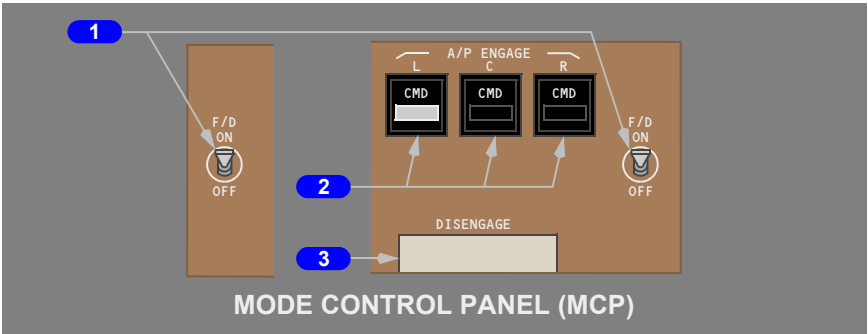

#### 1 Flight Director (F/D) Switches

The left and right flight director switches activate flight director steering indications on their respective flight mode annunciators (FMAs).

ON— respective pilots command bars operate in current AFDS mode.

- On the ground with no autopilot engaged and both F/D switches OFF, the first F/D switch positioned to ON arms the flight director in the takeoff (TO) roll and pitch modes. Positioning the second F/D switch to ON displays the flight director steering indications on the second FMA
- In flight, with the autopilot engaged and both F/D switches OFF, the first F/D switch positioned to ON activates the flight director in the selected autopilot mode(s)
- In flight with the autopilot disengaged and both F/D switches OFF, the first F/Ds switch positioned to ON engages the flight director in:

[Basic: Autopilot heading hold at AP engagement.]

- V/S as the pitch mode and HDG HOLD as the roll mode

[Option: Autopilot attitude (bank angle) hold at AP engagement.]

- or V/S and attitude (ATT) mode if bank angle is greater than five degrees
- command bars not in view if the autopilot, corresponding to the FCC selected for the flight director, is engaged in CMD

OFF –

- flight director steering indications do not display, unless
- the go-around switch is pushed when airspeed is greater than 80 knots and with the flaps not retracted

## **2 Autopilot (A/P) ENGAGE Switches**

Push (any switch can engage the autopilot) –

- CMD displays on each FMA
- if either F/D switch is ON, the autopilot engages in the selected flight director mode(s) except TO and GA
- if both F/D switches are OFF, the autopilot engages in:

[Basic: Autopilot heading hold at AP engagement.]

- V/S as the pitch mode and HDG HOLD as the roll mode

[Option: Autopilot attitude (bank angle) hold at AP engagement.]

- or V/S and attitude (ATT) mode if bank angle is greater than five degrees

## **3 Autopilot DISENGAGE Bar**

Push down –

- disengages all three autopilots
- prevents autopilot engagement
- exposes amber stripe

Lift up –

- enables autopilot engagement
- conceals amber stripe

## Autothrottle (A/T) System Controls

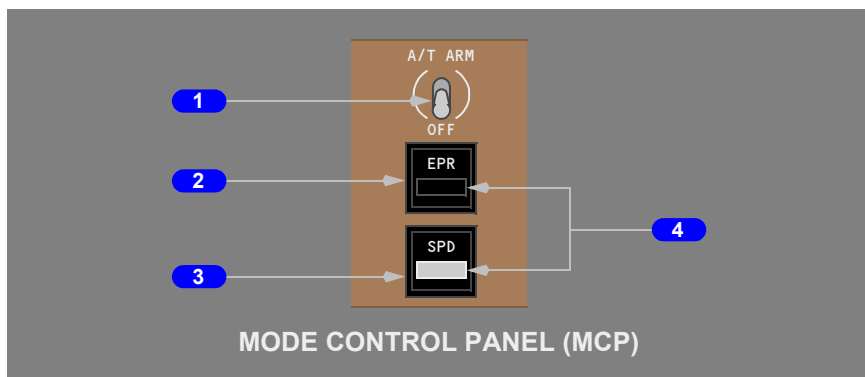

### 1 Autothrottle (A/T) ARM Switch

ARM –

- arms autothrottle system for mode selection
- autothrottle operates when EPR, SPD, V NAV, FL CH or GA switch pushed
- autothrottle operates when SPD switch pushed and pitch mode is ALT HOLD, V/S or G/S

OFF – disconnects autothrottle and prevents autothrottle engagement.

### 2 Engine Pressure Ratio (EPR) Switch

Push –

- selects autothrottle EPR mode
- EPR annunciates on each FMA
- autothrottle holds reference thrust value displayed on EICAS subject to maximum speed limits
- changes thrust reference from TO to CLB if above 400 feet radio altitude
- updates FMC position to takeoff runway threshold position when selected for takeoff only if GPS NAV is OFF (i.e. GPS NAV data not available to the FMC)

### 3 Speed (SPD) Switch

Push –

- selects autothrottle SPD mode
- SPD appears on each FMA
- autothrottle controls thrust to maintain IAS or MACH displayed in the speed window subject to minimum and maximum speed limits
- changes thrust reference from TO to CLB if above 400 feet radio altitude

#### 4 MCP Mode Switch Lights

All MCP mode switches contain a light that appears when the mode switch is selected to show the mode is engaged or armed.

### Autopilot Flight Director IAS/MACH Controls

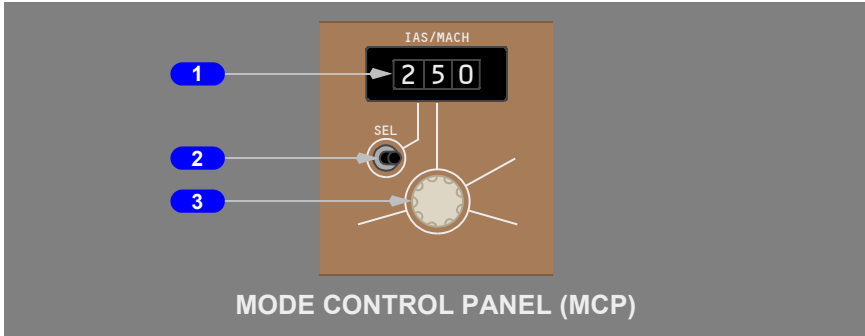

#### 1 IAS/MACH Window

Displays selected speed when IAS/MACH selector controls command speed.

Displays 200 knots when power first applied.

Blank when FMC controls command speed bugs.

Display range:

- 100 – 399 KIAS
- 0.40 – 0.95 MACH

In climb, changes from IAS to MACH at approximately 80 MACH.

In descent, changes from MACH to IAS at approximately 300 KIAS.

#### 2 Select (SEL) Switch

Push – alternately changes the IAS/MACH window between IAS and MACH.

#### 3 IAS/MACH Selector

Rotate –

- sets speed in IAS/MACH window and positions command airspeed bugs
- inoperative when IAS/MACH window blank

Push – when VNAV mode is engaged, alternately changes IAS/MACH window between current IAS or MACH and a blank display.

- VNAV active, window opens and speed control transfers from FMC to IAS/MACH selector
- descending in VNAV PTH, pitch mode changes to VNAV SPD. Selected speed maintained by pitch until airplane intercepts an altitude constraint and VNAV PTH reengages. Although, if on approach, pitch mode remains in VNAV PTH and autothrottle controls speed

## Autopilot Flight Director Roll and Pitch Controls

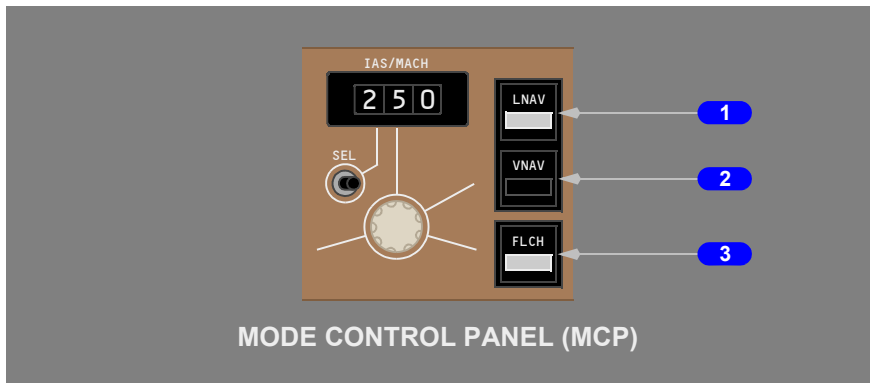

### **1** Lateral Navigation (L NAV) Switch

Push –

- Arms, engages or disarms LNAV as the roll mode.
- Displays LNAV in white (armed) on the roll flight mode annunciator when armed. The previous roll mode remains active.
- LNAV engages if the airplane is above 50 feet radio altitude and:
  - within 2.5 NM of the active leg
  - if not within 2.5 NM of the active leg and on an intercept heading to the active leg, remains armed then engages when approaching the active leg
  - when engaged, displays LNAV in green on roll flight mode annunciator
- selection of LNAV with the airplane not on a heading which intercepts the active leg, displays NOT ON INTERCEPT HEADING in the CDU scratch pads.
- Selection of LNAV when an active FMC route is not available displays NO ACTIVE ROUTE in the CDU scratchpad.

LNAV maintains current heading when:

- passing the last active route waypoint
- passing the last waypoint prior to a route discontinuity
- passing the last route offset waypoint
- activating the inactive route or activating an airway intercept and not within LNAV engagement criteria

LNAV deactivates:

- by selecting heading hold (HDG HOLD) or heading select (HDG SEL)
- when localizer is captured
- if there is a dual FMC failure.
- by pushing L NAV switch a second time when LNAV is armed

## **2 Vertical Navigation (V NAV) Switch**

Push –

- engages AFDS and A/T in VNAV mode
- VNAV PTH or VNAV SPD displays on each FMA
- AFDS and autothrottle follow vertical path and thrust guidance from FMCS
- changes thrust reference from TO to CLB if above 400 feet radio altitude

During climbs or descents, AFDS captures and holds altitude displayed in altitude window or FMC target altitude, whichever is reached first.

With VNAV engaged, pushing IAS/MACH selector permits manual speed selection. FMCs then use manually selected speeds for speed control.

VNAV deactivates:

- by selecting GA, FL CH, SPD or EPR, V/S or ALT HOLD
- by pushing VNAV switch a second time when VNAV is armed
- in climb or descent, reaching altitude displayed in altitude window prior to reaching FMCs target altitude
- passing top of descent point if the MCP is not set to an altitude below cruise altitude
- when glideslope is captured

## **3 Flight Level Change (FL CH) Switch**

Push –

- selects FLCH mode and sets IAS/MACH window and command airspeed bugs to current airspeed
- FLCH displays on each FMA

- AFDS pitch holds existing airspeed and A/T sets required thrust, limited by the thrust limit for climb and idle for descent. When selected altitude is reached, pitch mode changes to ALT HOLD and A/T changes to SPD mode
- with FLCH mode displayed, pushing switch resets IAS/MACH window and commands airspeed bugs to current airspeed
- changes thrust reference from TO to CLB if above 400 feet radio altitude

## **Autopilot Flight Director Heading and Bank Angle Controls**

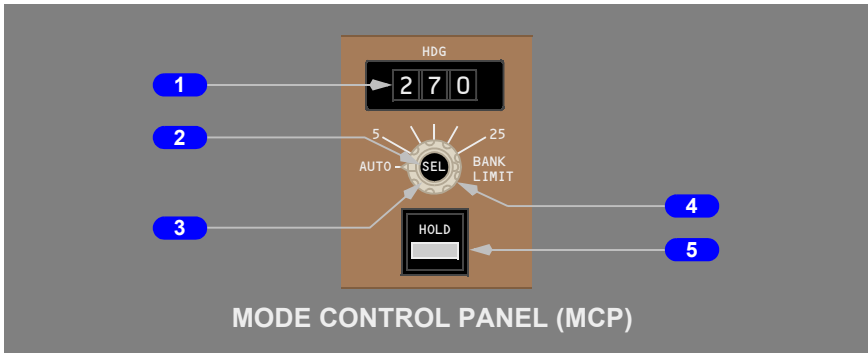

### **1 Heading (HDG) Window**

Displays selected heading and positions map display selected heading markers. HDG window and map headings set to 000 when power first applied. Automatically changes to ILS front course heading at LOC capture.

### **2 Heading Select (SEL) Switch**

Push –

- engages HDG SEL roll mode
- HDG SEL roll mode displays on each FMA
- AFDS controls roll to acquire and hold heading shown in heading window and on map heading markers
- bank is limited by bank limit selector

### **3 Heading Selector (inner)**

Rotate – sets heading in HDG window and positions selected heading marker on both map displays.

### **4 BANK LIMIT Selector (outer)**

Rotate – sets AFDS commanded bank limit when in HDG SEL roll mode as follows:

AUTO – bank angle varies between 15 – 25 degrees, depending on true airspeed.

- at slower true airspeeds the bank angle limit is 25 degrees
- as true airspeed increases, the bank angle limit decreases and at high true airspeeds the limit is 15 degrees

Manually selected – 5, 10, 15, 20, or 25 selected value is maximum regardless of airspeed.

### 5 Heading HOLD Switch

Push –

- selects HDG HOLD roll mode and displays on each FMA
- AFDS rolls wings level, then holds present heading

## Autopilot Flight Director Vertical Speed (V/S) Controls

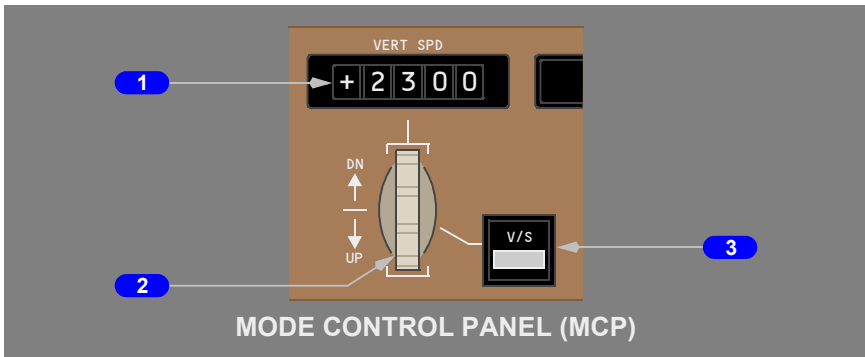

### 1 Vertical Speed (VERT SPD) Window

Displays selected vertical speed.

Blank when V/S pitch mode not selected.

Display range is from (-8000 to +6000 fpm) in 100 fpm increments.

### 2 Vertical Speed Selector (DN/UP)

UP or Down (DN) – sets vertical speed in VERT SPD window.

### 3 Vertical Speed (V/S) Switch

Push –

- selects V/S pitch mode and displays on each FMA
- displays current vertical speed in VERT SPD window
- when selected altitude reached, pitch flight mode annunciation changes to ALT HOLD



- AFDS pitch maintains vertical speed displayed in the VERT SPD window
- if AFDS is engaged in V/S from FLCH or from VNAV, A/T automatically engages in SPD mode if armed

## Autopilot Flight Director Altitude Controls

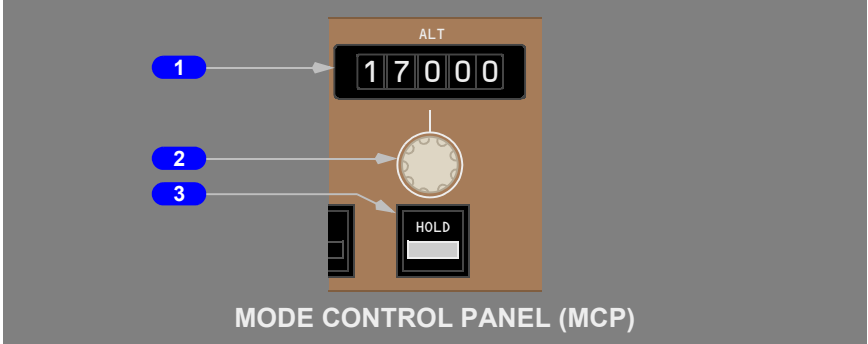

### 1 Altitude (ALT) Window

Displays selected altitude in 100 feet increments. Range: 0 to 50,000 feet. Displayed altitude is reference altitude, for altitude alerting and level off. ALT window set to 10,000 feet when power is first applied.

### 2 Altitude Selector

Rotate – sets altitude in ALT window.

### 3 Altitude HOLD Switch

Push –

- selects altitude ALT HOLD pitch mode
- ALT HOLD pitch mode displays on FMA
- AFDS commands pitch to maintain the altitude when the switch was pushed

## Autopilot Flight Director Approach Mode Controls

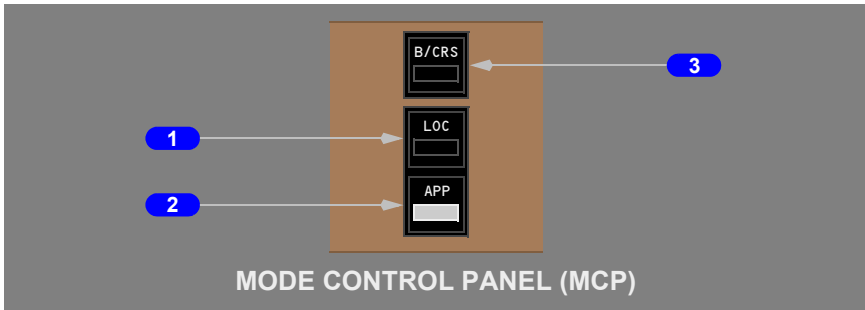

### 1 Localizer (LOC) Switch

Push –

- arms, disarms, captures LOC as roll mode
- displays LOC white (armed) on both FMA roll flight mode annunciations before localizer capture; current roll mode LNAV, HDG SEL or HDG HOLD remains active until LOC capture
- displays LOC green (engaged) on FMA roll flight mode annunciations after localizer capture
- arms AFDS to capture and track inbound on front course, capture point varies based on range and intercept angle
- localizer capture can occur when intercept track angle is within 120 degrees of the localizer course

**Note:** After localizer capture, flight director roll commands may appear inconsistent with A/P roll maneuvers for one to two minutes.

Localizer mode can be disarmed before localizer capture by:

- pushing localizer switch a second time
- arming LNAV

Localizer mode can be deactivated after localizer capture by:

- selecting a roll mode other than LNAV
- pushing a GA switch
- disengaging the autopilot and turning both F/D switches off

**Note:** The LOC mode is a single autopilot function only. Multiple autopilots cannot be engaged with this mode.

## 2 Approach (APP) Switch

Push –

- autopilot systems powered by separate sources with three autopilots engaged
- arms, disarms, or captures LOC as roll mode and glideslope (G/S) as pitch mode
- displays LOC and G/S white (armed) on FMA roll and pitch flight mode annunciations prior to localizer and glideslope capture
- displays LOC and G/S green (engaged) on both FMA roll and pitch flight mode annunciations after each is captured
- localizer captures when intercept track angle is within 120 degrees of localizer course

**Note:** After localizer capture, flight director roll commands may appear inconsistent with A/P roll maneuvers for one to two minutes.

- glideslope captures when intercept track angle to the localizer is within 80 degrees of localizer course
- AFDS captures and tracks localizer and glideslope upon intercepting the respective localizer and glideslope radio signals

[Basic: Glideslope inhibit before localizer capture.]

- localizer must be captured before glideslope

[Option: Glideslope enable before localizer capture.]

- either localizer or glideslope can be captured first

[Basic: Approach mode; automatic autopilot selection.]

- arms the other autopilot systems (CMD switch bars in view) for subsequent automatic engagement which occurs when localizer and glideslope are captured, and radio altitude is below 1500 feet

[Option: Approach mode; manual autopilot selection.]

- permits multi-autopilot selection and arming. Automatic engagement subsequently occurs when localizer and glideslope are captured, and radio altitude is below 1500 feet

Approach mode can be disarmed before localizer or glideslope capture by:

- pushing approach switch a second time
- pushing LOC switch (G/S disarms, LOC remains armed)
- pushing LNAV switch and LNAV arms (does not immediately engage)
- pushing VNAV switch and VNAV arms (does not immediately engage)

Approach mode deselects:

- with LOC captured and G/S armed, by selecting another roll mode other than LNAV; selecting LOC mode initiates a localizer approach.
- after LOC and/or G/S are captured, by selecting TO/GA mode or disengage autopilot and turn both F/D switches off

### 3 Backcourse (B/CRS) Switch

Push – (Must be used concurrently with LOC switch), arms or engages AFDS in B/CRS mode as follows:

B/CRS appears on each FMA prior to localizer capture.

- AFDS is armed to capture and track inbound on backcourse of localizer
- capture point varies based on range and intercept angle
- initial roll modes; LNAV, HDG SEL or HDG HOLD remain engaged until B/CRS capture
- before localizer capture, pushing the LOC switch a second time disarms both the LOC and B/CRS modes. Pushing only the B/CRS switch a second time, disarms the B/CRS mode but the LOC mode remains armed

B/CRS appears on each FMA after localizer capture.

- AFDS tracks inbound on backcourse
- if the LOC switch is selected and localizer is captured before B/CRS switch is pushed, AFDS will track the localizer front course (outbound) and B/CRS cannot be selected
- G/S, FLARE and ROLLOUT functions are not available

**Note:** The B/CRS mode is a single autopilot function only. Multiple autopilots cannot be engaged with this mode.

## Autoland Status

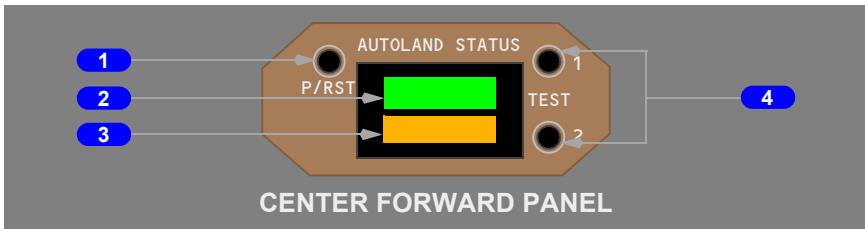

### 1 Push/Reset (P/RST) Switch

Push – resets both pilots annunciators as follows:

Before APP mode selected:

- changes NO AUTOLND or NO LAND 3 to blank,
- if condition is still present when switch is released, annunciation returns

After APP mode selected:

- if NO LAND 3 displayed, becomes blank and remains blank until after landing and autopilots disengaged
- if NO AUTOLND displayed, remains displayed until autopilots are disengaged

---

**2 AUTOLAND STATUS Annunciator (Upper)**

Normal (blank) –

LAND 3 – (green)

- indicates all three autopilot systems with their airplane system inputs are operating normally
- appears below 1500 feet radio altitude with LOC and G/S captured

LAND 2 – (green)

- indicates a minimum of two autopilot systems with their airplane system inputs are operating normally
- appears below 1500 feet radio altitude with LOC and G/S captured

**3 AUTOLAND STATUS Annunciator (Lower)**

Normal (blank) –

NO AUTOLND (amber) – indicates fault conditions exist which preclude the use of the autopilots for an automatic landing.

NO LAND 3 (amber) – indicates a fault condition exists which results in a LAND 2 condition.

**4 TEST Switches**

Push – activates autoland status annunciator tests.

## ADI Flight Mode Annunciations (FMAs)

[Option: Top flight mode annunciations (required for speed tape).]

[Option: Speed tape.]

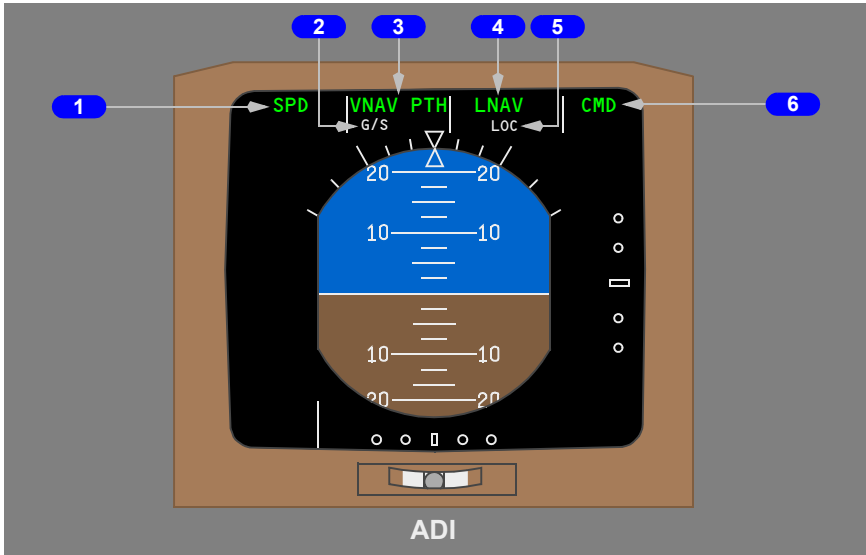

[Option: Top flight mode annunciations (required for speed tape).]

[Basic: Fast/Slow indicator.]

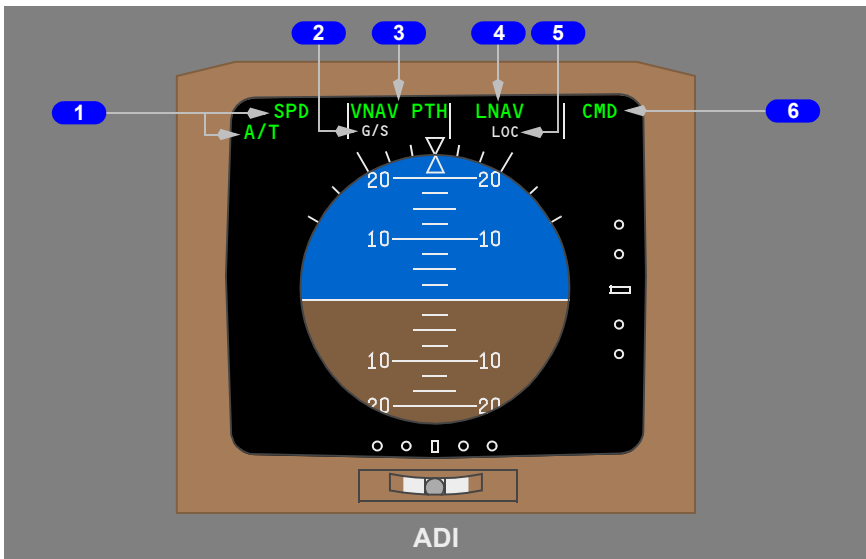

---

### **1** Autothrottle Modes (Active)

Displayed (green) – \*\*\*

- EPR
- SPD
- FLCH
- GA
- IDLE
- THR HLD

Autothrottle Limits: displayed (green) – \*/\*\*\*

- FLAP LIM
- ALPHA
- SPD LIM

[Option: Top flight mode annunciations.]

[Basic: Fast/Slow indicator.]

Autothrottle Status: displayed (green) – \*\*\*\*

- A/T
- F/S

### **2** AFDS Pitch Modes (Armed)

Displayed (white) –

- G/S
- FLARE
- VNAV

### **3** AFDS Pitch Modes (Active)

Displayed (green) – \*\*/ \*\*\*

- TO
- ALT HOLD
- V/S
- VNAV PTH
- VNAV SPD
- SPD
- G/S
- FLARE
- ALT CAP
- GA

AFDS Pitch Limits: displayed (green) – \*/\*\*\*

- FLAP LIM
- SPD LIM

#### **4 AFDS Roll Modes (Active)**

Displayed (green) – \*\*/ \*\*\*

[Basic: Autopilot heading hold at AP engagement.]

- HDG HOLD
- HDG SEL
- LNAV
- LOC
- ROLLOUT
- TO
- GA

[Option: Autopilot attitude (bank angle) hold at AP engagement.]

- ATT
- B/CRS

#### **5 AFDS Roll Modes (Armed)**

Displayed (white) –

- LOC
- ROLLOUT
- LNAV
- B/CRS

#### **6 AFDS (Active)**

Displayed (green) –

- CMD
- FD



[Basic: Fast/Slow indicator.]

[Basic: Bottom flight mode annunciations.]

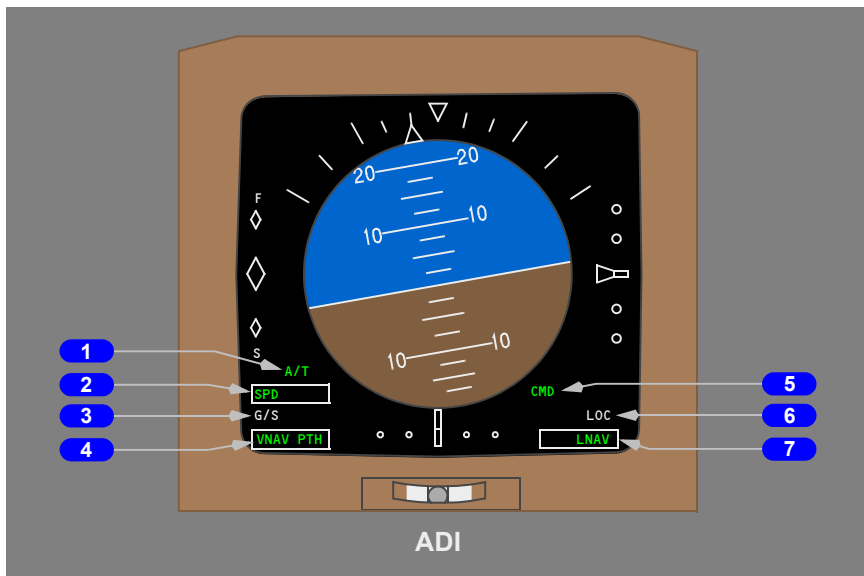

### **1** Autothrottle Status

Displayed (green) – \*\*\*\*

- A/T
- F/S

### **2** Autothrottle Modes (Active)

Displayed (green) – \*\*\*

- EPR
- SPD
- FLCH
- GA
- IDLE
- THR HOLD

Autothrottle Limits: displayed (green) – \*/\*\*\*

- FLAP LIM
- ALPHA
- SPD LIM

**3 AFDS Pitch Modes (Armed)**

Displayed (white) –

- G/S
- FLARE
- VNAV

**4 AFDS Pitch Modes (Active)**

Displayed (green) – \*\*/\*\*

- TO
- ALT HOLD
- V/S
- VNAV PTH
- VNAV SPD
- SPD
- G/S
- FLARE
- ALT CAP
- GA

AFDS Pitch Limits: displayed (green) – \*\*/\*\*

- FLAP LIM
- SPD LIM

**5 AFDS (Active)**

Displayed (green) –

- CMD
- FD

**6 AFDS Roll Modes (Armed)**

Displayed (white) –

- LOC
- ROLLOUT
- LNAV
- B/CRS

**7 AFDS Roll Modes (Active)**

Displayed (green) – \*\*/ \*\*

[Basic: Autopilot heading hold at AP engagement.]

- HDG HOLD
- HDG SEL
- LNAV
- LOC
- ROLLOUT
- TO
- GA

[Option: Autopilot attitude (bank angle) hold at AP engagement.]

- ATT
- B/CRS

\* Mode is operating with angle of attack (alpha) or airspeed limit. Limit mode annunciation replaces engaged mode annunciation.

\*\* An amber horizontal line is drawn through the appropriate autopilot pitch or roll mode annunciation when a flight mode fault is detected.

\*\*\*AFDS/Autothrottle mode changes are emphasized for 10 seconds by a box (green) drawn around the annunciated mode.

[Basic: Fast / Slow indicator.]

\*\*\*\*F/S appears only when autothrottle is disengaged, AFDS is not operating in a speed mode (FLCH or GA) and the present airspeed is approaching either the SPD LIM, ALPHA or FLAP LIM.

---

## Autopilot Disengage Switch

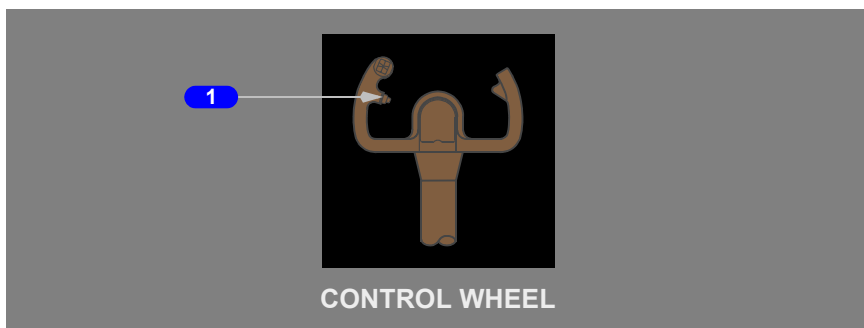

### **1** Autopilot Disengage Switches

Push (either switch) –

- disconnects all autopilots
- A/P DISC and master warning lights illuminate
- displays the EICAS warning message AUTOPILOT DISC

- sounds an aural warning
- if the autopilot automatically disengages, resets the master warning lights, EICAS warning message, and the aural warning

Second push – resets

- the master warning light
- EICAS warning message
- the aural warning

---

## Autothrottle Disconnect and Go-Around Switches

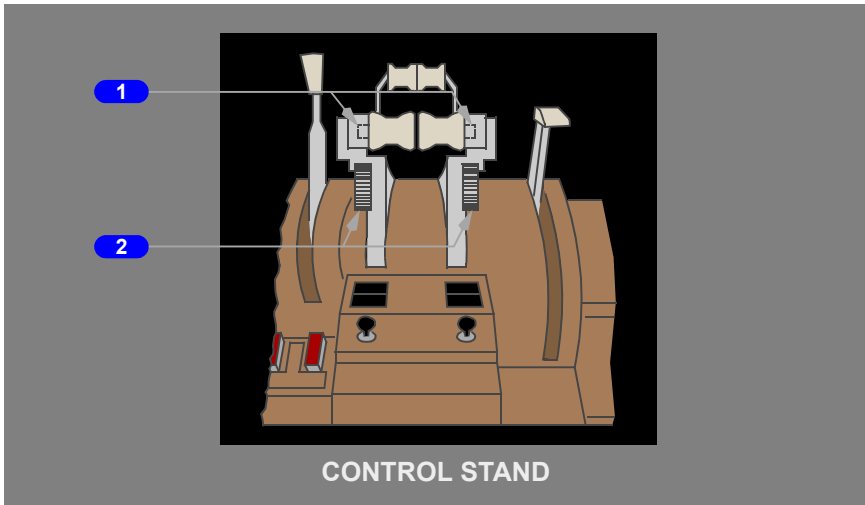

### 1 Autothrottle Disconnect Switches

Push (either switch) –

- disconnects autothrottle and A/T DISC light illuminates
- autothrottle remains armed
- subsequent push extinguishes light

### 2 Go-Around Switches

Push (either switch) –

- automatic arming occurs at glide slope capture or extension of wing flaps
- engages AFDS and autothrottle in GA mode if previously armed
- provides windshear guidance during GA mode if previously armed
- if flight director off, activates flight director in GA mode
- cancels all thrust derates if selected after takeoff

## Autoflight Lights

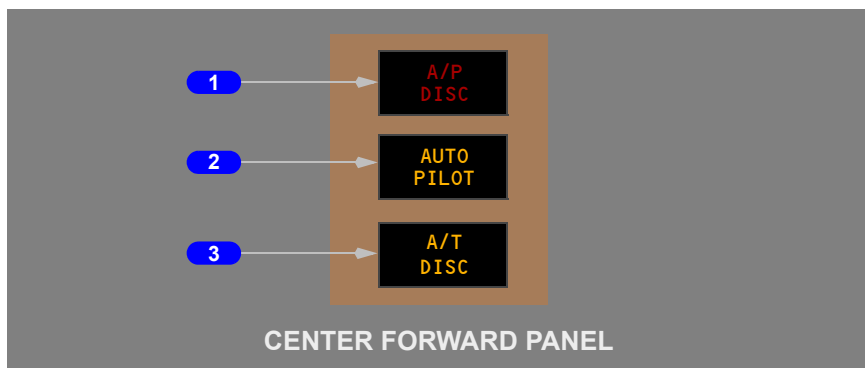

### 1 Autopilot Disconnect (A/P DISC) Light

Illuminated (red) –

- an autopilot has been automatically or manually disconnected
- extinguished by pushing either autopilot disengage switch

### 2 Autopilot (AUTO PILOT) Light

Illuminated (amber) –

- a degraded operating condition exists in engaged autopilot
- extinguished when condition is corrected or an alternate autopilot is selected, provided fault is not common to alternate autopilot

### 3 Autothrottle Disconnect (A/T DISC) Light

Illuminated (amber) –

- autothrottle has disconnected
- extinguished by pushing either autothrottle disconnect switch

Intentionally  
Blank

---

## Introduction

The automatic flight control system consists of the autopilot flight director system (AFDS) and the autothrottle system (A/T). The mode control panel (MCP) and flight management computer (FMC) control the AFDS and the autothrottle system to perform climb, cruise, descent and approach.

---

## Autopilot Flight Director System

The AFDS consists of three flight control computers (FCCs) and the MCP.

The MCP provides control of the autopilot, flight director, altitude alert, and autothrottle systems. The MCP selects and activates AFDS modes, and establishes altitudes, speeds, and climb/descent profiles.

The three FCCs, left, center, and right, control separate hydraulically powered autopilot control servos to operate flight controls. The autopilot controls ailerons and elevators. Rudder commands are added only during a multiple autopilot approach. Nose wheel steering is also added during rollout from an automatic landing. During an ILS approach with all three autopilots engaged, separate electrical sources power the three FCCs.

The FCCs also provide inputs for AFDS operating mode displays and flight director commands on the ADI.

## MCP Switches

MCP switches select automatic flight control and flight director modes. A light in the lower half of the switch illuminates to indicate the mode is armed or active. Respective roll and pitch flight mode annunciations on the ADI will also display. Autothrottle modes are discussed later in this section.

Most modes activate with a single push. These modes include:

- flight level change (FLCH)
- heading hold (HDG HOLD)
- heading select (HDG SEL)
- vertical speed (V/S)
- altitude hold (ALT HOLD)

Other modes arm or activate with a single push. These modes are:

- lateral navigation (LNAV)
- vertical navigation (VNAV)
- localizer (LOC)

- approach (APP)
- back course localizer (B/CRS)

All modes deactivate by disengaging the autopilot and turning both flight directors off. After localizer and glideslope capture, the localizer and glideslope modes can only be deactivated by disengaging the autopilot and turning both flight directors off or by selecting GA mode.

Desired target values can be selected on the MCP for:

- airspeed
- mach
- heading
- vertical speed
- altitude

All parameters except vertical speed can be preselected before autopilot and/or flight director engagement.

## **Autopilot Engagement**

Autopilot engagement requires at least one FCC and pushing one of the MCP autopilot engage switches.

## **Autopilot Disengagement**

Normal autopilot disengagement is through either control wheel autopilot disengage switch.

The autopilots can also be disengaged by the MCP autopilot disengage bar.

The A/P DISC light illuminates and the EICAS warning message AUTOPILOT DISC displays when the autopilot has been manually or automatically disconnected.

## **AFDS Failures**

During autopilot operation, failures affecting the active mode annunciate on the ADI. If the failure affects only the active mode:

- the autopilot remains engaged in an attitude stabilizing mode
- an amber line is drawn through the mode annunciation
- the AUTO PILOT light illuminates
- the EICAS caution message AUTOPILOT displays

If unwanted operation is noticed or when an autopilot failure is annunciated the autopilot should be disconnected and the airplane flown manually.

Failures affecting all autopilot modes result in an autopilot disengagement accompanied by an aural warning. Depending on the system failure, it may be possible to reengage an autopilot by pushing the autopilot engage switch.



---

## **Flight Director Display**

Flight director steering indications normally display any time the related F/D switch is ON.

The steering indications are also displayed when the related flight director switch is OFF and a go-around switch is pushed, if airspeed is greater than 80 knots and the flaps are not retracted. In this case, the flight director display can be removed by cycling the respective flight director switch on and then off.

A flight director failure in either pitch or roll, causes the respective steering bars to disappear.

## Autopilot Flight Director System Schematic

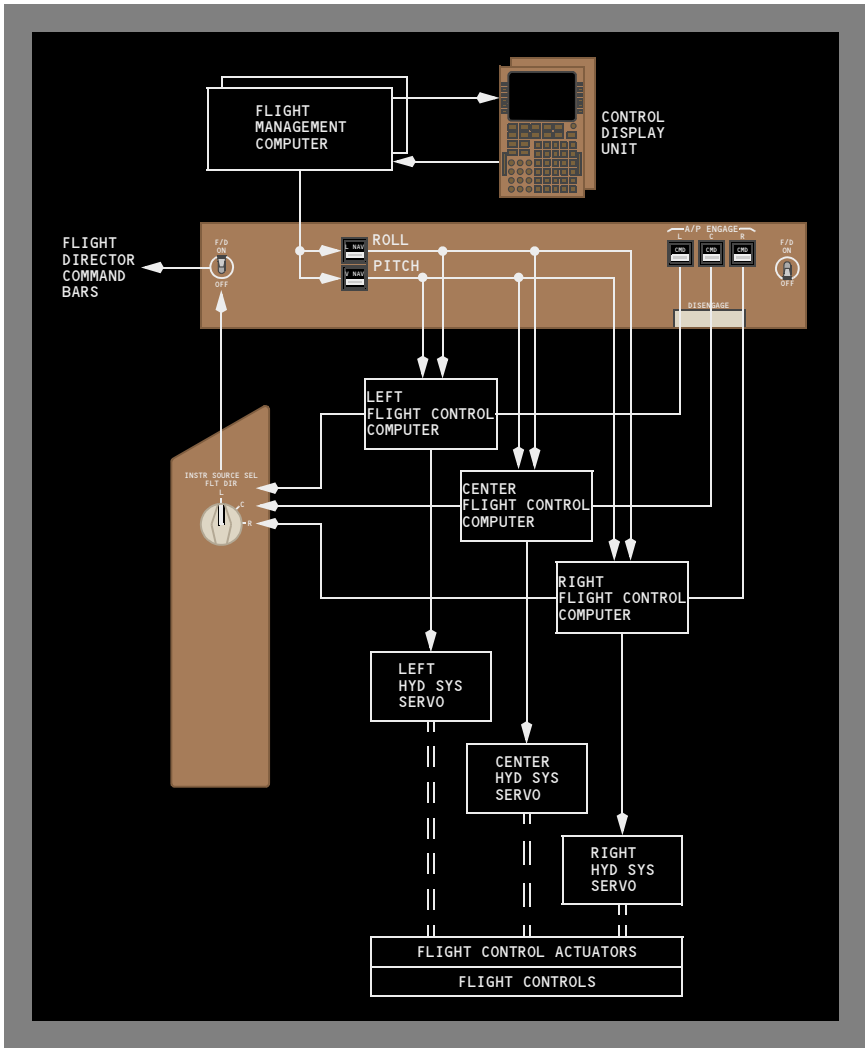

### Autoland Status Annunciators (ASA)

The following AFDS status annunciations can be displayed:

- LAND 3 – three autopilots engaged and operating normally for an automatic landing
- LAND 2 – AFDS redundancy reduced, in some cases only two autopilots available

- NO LAND 3 – indicates a fault condition exists which results in a LAND 2 condition
- NO AUTOLND – AFDS unable to make an automatic landing

With a LAND 3 indication, the autopilot system level of redundancy is such that a single fault cannot prevent the autopilot system from making an automatic landing (fail operational).

With a LAND 2 indication, the level of redundancy is such that a single fault cannot cause a significant deviation from the flight path (fail passive).

Below 200 feet radio altitude the ASA display cannot change except to indicate a NO AUTOLND condition. Faults not requiring immediate crew action or awareness are annunciated after touchdown.

### **AFDS Flight Mode Annunciations**

Flight mode annunciations display above AFDS status annunciations. Mode annunciations from left to right are:

- autothrottle
- pitch
- roll
- AFDS status

Active modes display at the top of the flight mode annunciation boxes in large green letters. Armed modes (except for TO on the ground and GA in flight) display in smaller white letters at the bottom of the flight mode annunciator boxes.

### **Autothrottle Modes**

Autothrottle annunciations are:

- EPR – autothrottle controlling to the selected EPR reference thrust
- SPD – autothrottle controlling thrust to maintain speed selected in IAS/MACH or, if VNAV engaged, the speed as programmed by the FMC
- IDLE – autothrottle is reducing or has reduced thrust to idle. It may engage in a VNAV descent. It will, after FLARE is engaged

[Basic: Bottom flight mode annunciations.]

- THR HOLD – thrust levers remain in existing position or where manually placed

[Option: Top flight mode annunciations.]

- THR HLD – thrust levers remain in existing position or where manually placed

- FLCH – autothrottle controlling to a maximum of the selected mode reference thrust during climb, and to a minimum thrust during descent
- GA – autothrottle controlling to a maximum reference thrust to maintain a climb rate of at least 2000 fpm. If both flight directors and the autopilot are off, autothrottle controls to go-around reference thrust subject to flap and VMO limit speeds

## Roll Modes

Roll annunciations are:

LNAV –

[Basic: Bottom flight mode annunciations.]

Arm LNAV by pushing the L NAV switch. The light illuminates and LNAV annunciates on the ADI roll mode annunciator in white characters above the current roll mode.

[Option: Top flight mode annunciations.]

Arm LNAV by pushing the L NAV switch. The light illuminates and LNAV annunciates on the ADI roll mode annunciator in white characters below the current roll mode.

- LNAV (armed) – LNAV is armed to activate when parameters are met
- LNAV (active) – LNAV activates when in position to turn onto the active route leg. In flight, selection causes immediate activation if within 2 1/2 NM of the active leg

[Basic: Autopilot heading hold at AP engagement.]

HDG –

- HDG SEL (active) – airplane turns to or maintains the heading selected in the MCP heading window
- HDG HOLD (active) – AFDS holds present heading. When turning, AFDS holds the heading reached after rolling wings level

[Option: Autopilot attitude (bank angle) hold at AP engagement.]

ATT –

- ATT (active) – when the autopilot is first engaged or the flight director is first turned on in flight, AFDS holds a bank angle between 5 and 30 degrees and will not roll to wings level
- when the bank angle is less than 5 degrees, AFDS returns to wings level HDG HOLD
- when the bank angle is greater than 30 degrees, AFDS returns to 30 degrees of bank

---

LOC –

- LOC (armed) – AFDS captures the localizer when within range and within 120 degrees of the localizer course
- LOC (active) – AFDS follows the localizer course

B/CRS –

- B/CRS (armed) – AFDS is armed to capture and track inbound on backcourse of localizer after localizer capture
- B/CRS (active) – AFDS tracks inbound on backcourse of localizer

TO –

- On the ground, TO annunciates by selecting either F/D switch ON when both flight directors are OFF
- TO roll and pitch guidance become active at lift-off

GA –

- In flight, go-around arms with flaps out of up or at glideslope capture. There is no flight mode annunciation for go-around armed in flight; although the reference thrust limit changes to GA. Go-around is activated in flight by pushing a GA switch. The roll steering indication provides guidance to maintain the ground track present at mode engagement

ROLLOUT –

- ROLLOUT (armed) – displays below 1500 feet radio altitude and activates below 5 feet
- ROLLOUT (active) – after touchdown, AFDS uses rudder and nose wheel steering to steer the airplane on the localizer centerline

**Pitch Modes**

Pitch annunciations are:

TO –

On the ground, TO annunciates by selecting either F/D switch ON when both flight directors are OFF. The flight director pitch bar indicates an initial pitch of approximately eight degrees up.

After takeoff, the AFDS commands a pitch attitude to maintain:

- pitch command greater of  $V_2 + 15$  or liftoff speed + 15
- if current airspeed remains above the target speed for 5 seconds, target airspeed resets to current airspeed, to a maximum of  $V_2 + 25$  knots
- IAS/MACH window speed if IAS/MACH window speed is changed to a speed greater than the target speed

**Note:** AFDS uses the speed set in the IAS/MACH window prior to takeoff for  $V_2$ .

GA –

Go-around arms and the reference thrust limit changes to GA when flaps are out of up or at glideslope capture.

When a go-around is initiated, the commanded speed is the MCP IAS/MACH window or current airspeed, whichever is higher. If the airspeed increases and remains above the initial target airspeed for five seconds, target airspeed resets to current airspeed to a maximum of the IAS/MACH window speed plus 25 knots. If airspeed at initiation of go-around is greater than IAS/MACH window plus 25 knots, that speed is maintained. GA displays as the reference thrust limit on the primary EICAS engine display.

VNAV –

[Basic: Bottom flight mode annunciations.]

Arm VNAV by pushing the V NAV switch. The light illuminates and VNAV annunciates on the ADI pitch mode annunciator in white characters above the current pitch mode.

[Option: Top flight mode annunciations.]

Arm VNAV by pushing the V NAV switch. The light illuminates and VNAV annunciates on the ADI pitch mode annunciator in white characters below the current pitch mode.

VNAV provides pitch commands to maintain the FMC computed airspeed/path:

- VNAV SPD (active) – the AFDS maintains the FMC speed displayed on the ADI and/or the CDU CLIMB or DESCENT pages. During speed intervention, use the MCP IAS/MACH selector to manually set the speed
- VNAV PTH (active) – the AFDS maintains FMC altitude or descent path with pitch commands. For a non-entered headwind, thrust may increase to maintain the VNAV descent path. If the MCP altitude window is set to the current cruise altitude as the airplane approaches the top of descent, the CDU scratchpad message RESET MCP ALT displays
- when a VNAV descent is initiated before the top of descent (T/D) and the airplane descent path subsequently intercepts the VNAV descent path, the pitch annunciation changes from VNAV SPD to VNAV PTH

V/S –

Pushing the V/S switch opens the vertical speed window and displays the current vertical speed. It also opens the IAS/MACH window (if blanked). Pitch commands maintain the rate of climb or descent selected in the V/S window.

SPD –

Pushing the SPD switch opens the IAS/MACH window (if blanked). Pitch commands maintain IAS/MACH window airspeed or Mach.

ALT CAP –

A transition maneuver entered automatically from a V/S, FLCH, or VNAV climb or descent to selected MCP altitude. Engages but does not announce during VNAV transition.

**ALT HOLD** –

Altitude hold mode is activated by:

- pushing the MCP altitude HOLD switch, or
- capturing the selected altitude from a V/S or FLCH climb or descent

**G/S** –

Autopilot flight director system follows the ILS glideslope.

**FLARE** –

- FLARE (armed) – during autoland, FLARE displays below 1500 feet radio altitude
- FLARE (active) – during autoland, flare activates at 45 feet radio altitude. FLARE deactivates at touchdown and the nose wheel smoothly lowers to the runway

---

## **Autothrottle System**

The autothrottle system provides thrust control from takeoff through landing.

Autothrottle mode and speed selection is controlled from the MCP and the thrust mode select panel (TMSP). When in VNAV, the FMC selects autothrottle modes and target thrust values. Refer to Chapter 11, Flight Management, Navigation, for FMS and CDU operation.

With a command speed of VREF + 5 knots and landing flaps, there is sufficient wind and gust protection available with the autothrottle engaged. The autothrottle adjusts thrust quickly when the airspeed decreases below the command speed. The autothrottle decreases thrust slowly when the airspeed is more than the command speed. In turbulence, the result is that the thrust average is higher than necessary to keep the command speed. This causes the speed average to be more than the command speed.

The autothrottle can be operated without using the flight director or the autopilot.

The autothrottle can be manually overridden or disconnected by using either A/T disconnect switch.

## **Thrust Management Computer**

The thrust management computer (TMC) controls the autothrottle system through manual inputs from the MCP or automatically from the FMCs while VNAV is engaged. The basic TMC functions are to:

- calculate thrust limits and settings or follow FMC thrust settings
- detect and transmit autothrottle failures

- actuate the thrust levers

[Basic: Fast/Slow indicator.]

- generate fast slow indications for display on the ADIs

## Thrust Mode Select Panel

The thrust mode select panel (TMSP) provides the following functions:

[Basic: Autothrottle no takeoff derates.]

- selection of reference thrust modes (TO, GA, CLB, CON, CRZ)

[Option: Autothrottle takeoff derates.]

- selection of fixed and assumed temperature derated reference thrust values

## Autothrottle Thrust Lever Operation

The autothrottle system moves both thrust levers together to control speed or thrust, depending on the engaged mode.

[Basic: Bottom flight mode annunciations.]

Thrust levers can be manually positioned without disconnecting the autothrottle. After manual positioning, the autothrottle system repositions the thrust levers to comply with the engaged mode. The autothrottle system does not reposition the thrust levers while in THR HOLD mode.

[Option: Top flight mode annunciations.]

Thrust levers can be manually positioned without disconnecting the autothrottle. After manual positioning, the autothrottle system repositions the thrust levers to comply with the engaged mode. The autothrottle system does not reposition the thrust levers while in THR HLD mode.

## Autothrottle Disconnect

The autothrottle system can be disconnected manually by positioning the A/T arm switch to OFF or by pushing either thrust lever A/T disconnect switch.

Autothrottle disconnect occurs if a fault in the active autothrottle mode is detected, or when a reverse thrust lever is raised to reverse idle. The A/T DISC light illuminates and the EICAS caution message AUTOTHROT DISC displays.



## Automatic Flight Operations

### Automatic Flight – Takeoff and Climb Profile

[Option: Top flight mode annunciations.]

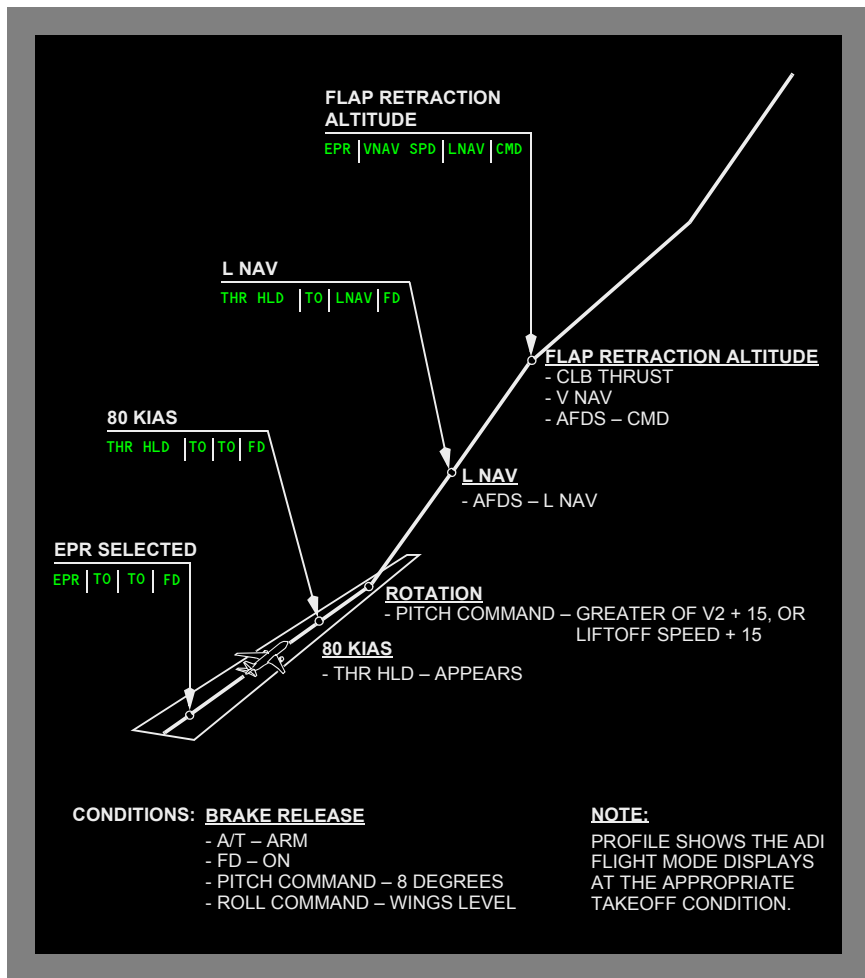

[Basic: Bottom flight mode annunciations.]

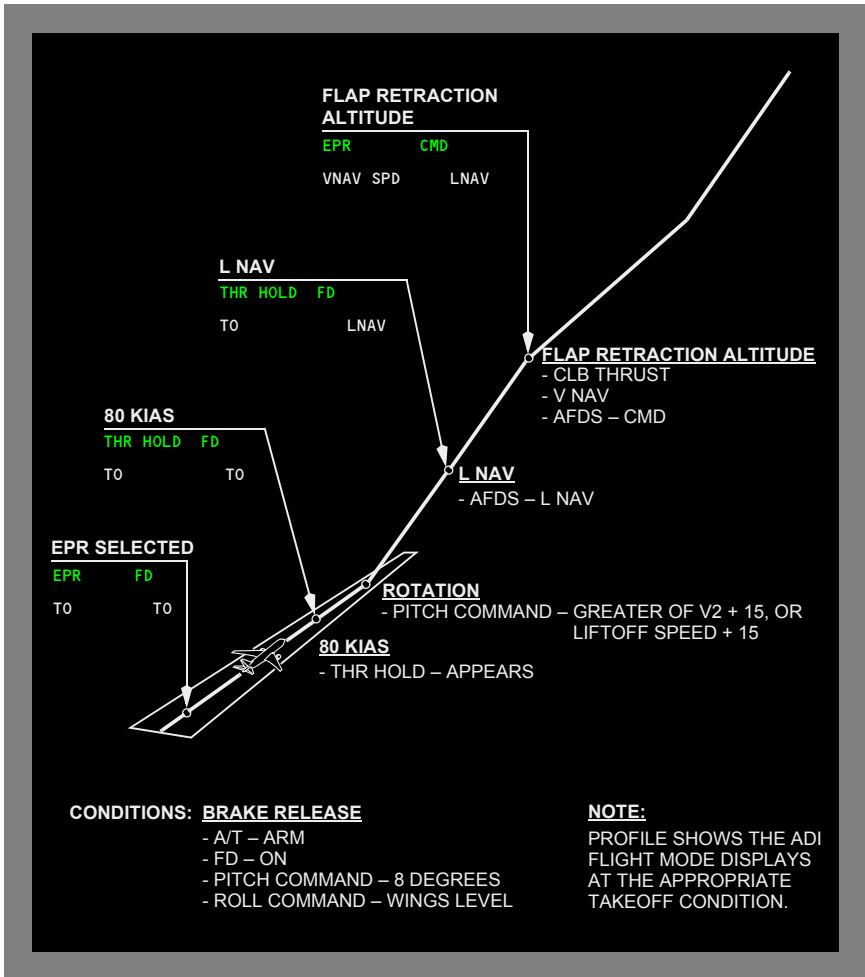

Takeoff is a flight director only function and can only be engaged on the ground. The autopilot is not used during the takeoff roll but may be engaged after liftoff.

During preflight:

- with the autopilot disengaged and both F/D switches OFF, activation of TO roll and pitch mode occurs when the first F/D switch is positioned ON
- ADI displays FD as AFDS status and TO as the pitch and roll flight mode annunciations
- command steering bars come into view

On takeoff, prior to 80 knots IAS:

- pitch command is set to approximately eight degrees up
- roll command is wings level
- autothrottle is engaged in EPR by pushing EPR switch, thrust levers advance to takeoff EPR
- ADIs display EPR for autothrottle and TO for both pitch and roll modes

During takeoff and prior to lift-off:

[Basic: [Bottom flight mode annunciations.](#)]

- at 80 knots, autothrottle annunciation changes to THR HOLD

[Option: [Top flight mode annunciations.](#)]

- at 80 knots, autothrottle annunciation changes to THR HLD

At lift-off:

- pitch command greater of  $V_2 + 15$  or liftoff speed + 15
- if an engine failure occurs on the ground, the pitch command target speed at lift-off is  $V_2$  or airspeed at lift-off, whichever is greater
- roll command maintains ground track

After lift-off:

- FD TO modes are terminated by engaging an A/P in CMD, or selecting any other pitch or roll mode

[Basic: [Bottom flight mode annunciations.](#)]

- A/T remains in THR HOLD mode at takeoff thrust until a pitch mode, A/T mode, or thrust reference mode select switch is pushed. The A/T then sets climb thrust or the selected reference thrust

[Option: [Top flight mode annunciations.](#)]

- A/T remains in THR HLD mode at takeoff thrust until a pitch mode, A/T mode, or thrust reference mode select switch is pushed. The A/T then sets climb thrust or the selected reference thrust

[Basic: [Bottom flight mode annunciations.](#)]

- A/T remains in THR HOLD mode at takeoff thrust until a thrust reference mode select switch is pushed. The A/T then sets the selected reference thrust

[Option: [Top flight mode annunciations.](#)]

- A/T remains in THR HLD mode at takeoff thrust until a thrust reference mode select switch is pushed. The A/T then sets the selected reference thrust

[Basic: Fast/Slow indicator.]

- Fast/Slow pointer appears on ADIs following selection of a thrust mode other than TO and a FD mode other than TO

**Note:** Autopilot elevator authority during a single autopilot operation is limited to reduce the effects of an autopilot malfunction. During altitude capture, there may be insufficient elevator authority and stabilizer trim rate to counteract pitch down, caused by the combination of thrust reduction, flap retraction and aft c.g.

**Note:** An altitude capture from a climb that includes a significant airspeed increase or thrust reduction may result in the autopilot descending away from the selected altitude in an attempt to increase the airspeed.

## Automatic Flight – Cruise

The autopilot and/or flight director can be used after takeoff to fly a lateral navigation track (LNAV) and a vertical navigation track (VNAV) provided by the FMC. Using LNAV and VNAV ensures the most economical operation.

## Automatic Flight – Approach and Landing

[Option: Approach mode; manual autopilot selection.]

The AFDS provides guidance for single or multiple autopilot precision approaches. Pushing the APP switch arms localizer in the roll mode and glideslope in pitch mode. With any single autopilot engaged, manual arming of one, or both of the remaining two (by selecting them to CMD) is necessary for a multiple autopilot approach.

[Basic: Approach mode; automatic autopilot selection.]

The AFDS provides guidance for multiple autopilot precision approaches. Pushing the APP switch arms localizer in the roll mode and glideslope in the pitch mode. Also, with an autopilot engaged, the remaining two autopilots automatically arm for a multiple autopilot approach.

[Basic: Glideslope inhibit before localizer capture.]

Glideslope capture is inhibited until the localizer is captured.

Pushing the LOC switch arms the AFDS for localizer tracking. Descent on the localizer can be accomplished using VNAV, FLCH or V/S pitch modes. The localizer mode cannot capture if the intercept angle exceeds 120 degrees. All other nonprecision approaches can be flown using LNAV and VNAV modes, or HDG SEL or V/S modes.

Pushing the B/CRS switch in conjunction with the LOC switch will enable localizer backcourse tracking.

**Runway Alignment and Asymmetric Thrust Compensation**

AFDS controls rudder during multiple autopilot ILS approaches to compensate for engine-out asymmetric thrust conditions during an ILS approach.

With LAND 3 or LAND 2 annunciated, autopilot control of the rudder is active.

The runway align submode is operative during multiple autopilot ILS approach. It reduces the crab angle established during crosswind conditions prior to automatic landing. The submode operates as follows:

- actuated at 500 feet radio altitude with LAND 3 or LAND 2 annunciated
- activation not displayed
- autopilot systems initiate a slip with a maximum bank angle of two degrees when the crab angle exceeds five degrees
- wing leveling from the slip is initiated when the ROLLOUT mode is engaged

If the autopilots are disengaged, manually or automatically, in an asymmetric thrust condition with rudder control active, the rudder moves to the trimmed position. The pilot may need to exert rudder pedal force to maintain a smooth transition to manual flying.

**Flare**

The flare maneuver brings the airplane to a smooth automatic landing touchdown. The flare submode is a multiple autopilot mode, and is not intended for single autopilot or flight director only operation.

At approximately 45 feet radio altitude, the autopilots start the flare maneuver. FLARE replaces the G/S pitch flight mode annunciation.

Flare arms when LAND 3 or LAND 2 annunciates.

During flare:

- at 25 feet radio altitude the autothrottle retards thrust levers to idle
- IDLE replaces the SPD autothrottle flight mode annunciation
- if slip exists due to runway align submode, wings levelled when ROLLOUT mode engaged
- autopilots start lowering the nose smoothly to the runway
- at touchdown, the FLARE annunciation no longer displays, and the nose lowers to the runway

**Note:** During an approach with LAND 2 annunciated on the ASA and below 330 feet radio altitude an increment of nose up trim is automatically applied for flare. If the autopilots are subsequently disengaged in the approach, a forward control column force of 20–30 pounds may be required to counter the automatic trim condition. If an automatic multi-autopilot go-around is performed, the increment of automatic trim is removed.

## Rollout

Rollout arms when LAND 3 or LAND 2 annunciates.

At approximately five feet radio altitude, rollout activates. ROLLOUT replaces the LOC roll flight mode annunciation.

The autopilot controls the rudder and nose wheel steering to keep the airplane on the localizer centerline.

Rollout guidance continues until a full stop or until the autopilots are disengaged.

During rollout, autothrottle IDLE mode remains active until the autothrottle disengages. Autothrottle disengagement occurs when either thrust lever is set in reverse thrust position. When selecting reverse thrust the A/T DISC caution light, AUTOTHROT DISC EICAS message and aural warning will not be activated.

## Automatic Flight – Approach Profile

[Option: Top flight mode annunciations.]

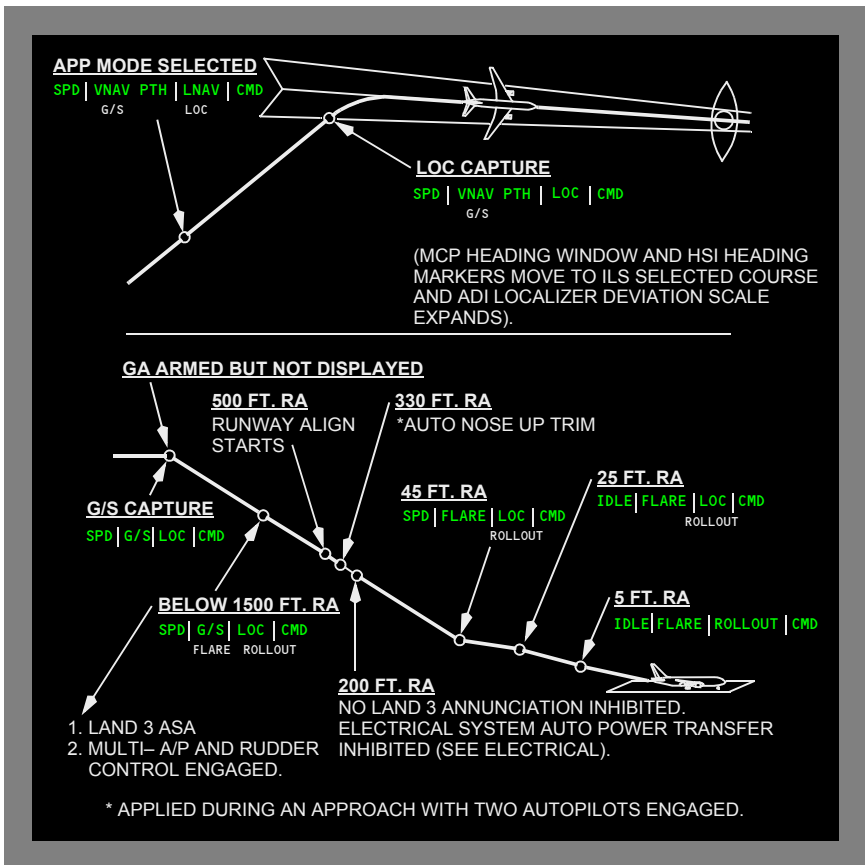

[Basic: Bottom flight mode annunciations.]

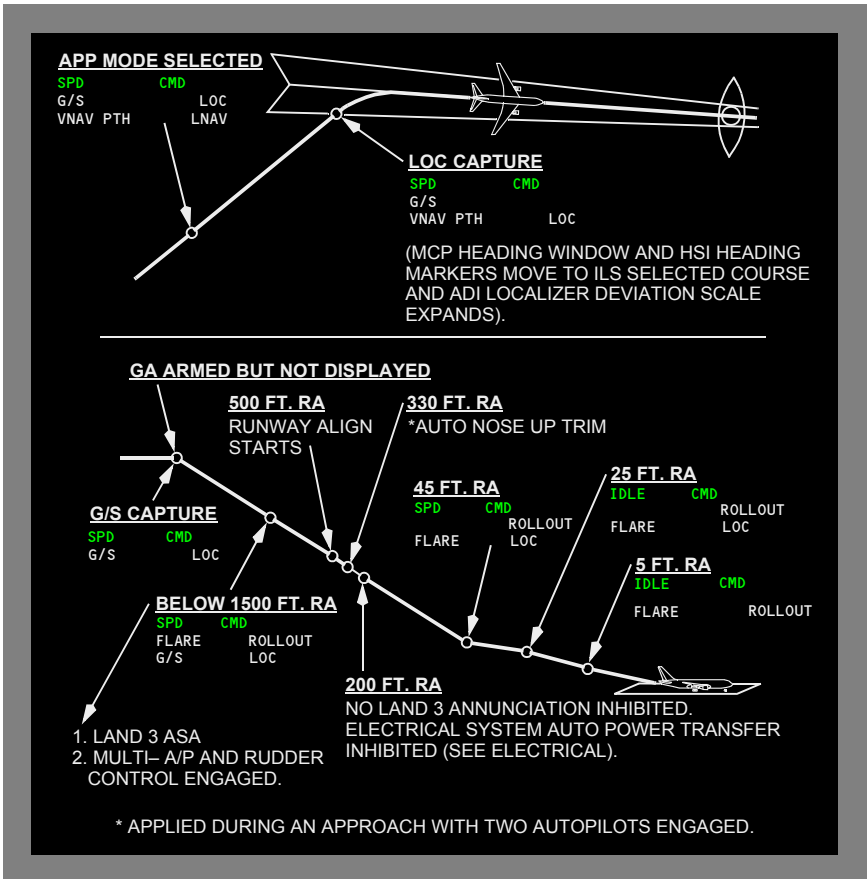

## Automatic Flight – Go-Around

Pushing either GA switch activates a go-around using multiple autopilot, single autopilot or flight director only.

When the F/D switches are not on, pushing either GA switch displays the flight director bars.

Go-around arms and the reference thrust limit changes to GA when the flaps are out of up or glideslope is captured. Arming is not annunciated. GA remains armed until two seconds after five feet radio altitude. Pushing either GA switch during this period of the approach engages the GA mode. The mode remains active even if the airplane touches down while executing the go-around.

If the airplane is floating within five feet radio altitude for more than two seconds when the GA switch is pushed, the autopilot pitch mode will remain in FLARE and the autothrottle go-around mode will engage.

If the airplane is on the ground but has been below five feet radio altitude for less than two seconds when the GA switch is pushed, the autopilot go-around pitch mode will engage but the autothrottle mode will remain IDLE.

The GA switches are interlocked with the thrust reversers to prevent go-around mode engagement during reverse thrust operation.

Pushing either GA switch:

- roll and pitch activate in GA on ADI
- autothrottle increases thrust to establish a climb rate of at least 2000 fpm
- roll commands bank to maintain ground track
- AFDS increases pitch to hold existing speed or the selected MCP speed, whichever is higher, as thrust increases
- if flap setting is 20 or less, a thrust mode other than go-around can be selected

**Note:** Autopilot elevator authority during a single autopilot approach is limited to reduce the effects of an autopilot malfunction. If a go-around is initiated during a single autopilot approach, there may be insufficient elevator authority and stabilizer trim rate to counteract pitch up, caused by a rapid application of full go-around thrust. There is sufficient elevator authority to counteract pitchup when the go-around is flown using multiple autopilots, or manually (no autopilot), or when the autothrottle go-around mode is used to set a 2000 FPM climb rate.

GA level-off:

- at the selected altitude, the AFDS pitch flight mode annunciation changes to ALT CAP, then to ALT HOLD, and autothrottle mode changes to SPD
- GA remains the active roll mode until another mode is selected
- landing gear and flaps must be operated manually

GA Mode Termination:

Below 400 feet radio altitude –

- if flap setting is 25 or 30, autothrottle remains in GA mode unless disengaged
- disengage autopilot and turn off both flight directors



---

Above 400 feet radio altitude –

- select a different roll or pitch mode; all autopilots, except first in CMD, disengage

**Note:** If the autopilot systems are compensating for an asymmetric thrust condition when they revert to a single autopilot in CMD configuration, the rudder will return to the trimmed position unless the pilot exerts the rudder pedal force required to maintain the rudder position.

---

## Automatic Flight – Windshear Recovery

The AFDS provides windshear recovery guidance by means of the normal go-around pitch and roll modes. With go-around armed, pushing a GA switch commands a pitch-up of 15 degrees or slightly below the pitch limit, whichever is lower.

When the autopilot is not engaged when go-around is initiated, the pilot must fly the windshear recovery following the flight director commands. If the autothrottle is not armed or engaged, the thrust levers must be advanced manually.

---

## Automatic Flight Limit Modes

Autothrottle Limit Modes:

- FLAP LIM
- ALPHA
- SPD LIM

Pitch Limit Modes:

- FLAP LIM
- SPD LIM

Flap placards speeds, airplane maximum angle of attack and maximum speed limit are automatically monitored by the AFDS and TMC. The appropriate speed limit mode annunciation of FLAP LIM, ALPHA, or SPD LIM is displayed when a speed limit is approached and the MCP selected speed or FMC target speed is set to exceed a limit. When the limit mode is displayed, the limit speed becomes the reference speed for the autothrottle and AFDS.

When the AFDS is engaged in a speed mode (FLCH, GA), the speed limit monitoring is accomplished by the AFDS. When approaching a speed limit, the appropriate limit mode annunciation, replaces the existing pitch mode.

The AFDS will not annunciate ALPHA when approaching maximum angle of attack speed, however, the alpha safe speed will be maintained by AFDS pitch.

[Basic: Fast/Slow indicator.]

When the AFDS is not controlling speed, speed limit monitoring is accomplished by the TMC. When a speed limit is exceeded, the appropriate limit mode annunciation appears at the autothrottle mode position. The speed limit mode annunciations may appear when the autothrottles are engaged or not engaged.

[Basic: Fast/Slow indicator.]

The Fast/Slow pointer changes color to amber and the pointer flashes when a speed limit is exceeded.

#### Automatic Flight EICAS Messages

The following EICAS messages can be displayed.

Message	Level	Light	Aural	Condition
AUTOPILOT	Caution	AUTO PILOT	Beeper	The engaged autopilot is operating in a degraded mode. Engaged roll and/or pitch mode may have failed.

[Basic: Autopilot disconnect warning - siren.]

AUTOPILOT DISC	Warning	A/P DISC	Siren	The autopilot has disconnected.
----------------	---------	-------------	-------	---------------------------------

[Option: Autopilot disconnect warning - wailer.]

AUTOPILOT DISC	Warning	A/P DISC	Wailer	The autopilot has disconnected.
----------------	---------	-------------	--------	---------------------------------

AUTOTHROT DISC	Caution	A/T DISC	Beeper	The autothrottle has disconnected.
----------------	---------	-------------	--------	------------------------------------

Intentionally  
Blank

<b>Controls and Indicators</b> .....	<b>5.10</b>
Audio Control Panel .....	5.10.1
Pilot Call Panel .....	5.10.2
Radio System .....	5.10.3
VHF Communication Panel .....	5.10.3
HF Communication Panel .....	5.10.4
Miscellaneous Communication Controls .....	5.10.5
Control Wheel Microphone/Interphone Switch .....	5.10.5
Service Interphone Switch .....	5.10.5
Flight Deck Speaker .....	5.10.6
Captain/First Officer/First Observer Jack Panels .....	5.10.6
ACARS or SATCOM Control .....	5.10.7
ACARS Access Through Control Display Units (CDU) .....	5.10.7
Cockpit Voice Recorder Panel .....	5.10.8
Emergency Locator Transmitter .....	5.10.9
<b>System Description</b> .....	<b>5.20</b>
Introduction .....	5.20.1
Audio Control Panels .....	5.20.1
Radio Communication Systems .....	5.20.2
HF Communication System .....	5.20.2
VHF Communication System .....	5.20.2
Selective Calling (SELCAL) System .....	5.20.3
Aircraft Communication Addressing and Reporting System (ACARS) .....	5.20.3
Voice Recorder System .....	5.20.3
Fuselage Mounted Emergency Locator Transmitter (ELT) .....	5.20.4
Communication Crew Alerting System .....	5.20.4
Crew Communications Messages .....	5.20.4
Communication Alert Categories .....	5.20.4
Selective Calling (SELCAL) Messages .....	5.20.5

---

<b>Interphone Systems</b> .....	<b>5.30</b>
Interphone Communication System.....	5.30.1
Flight Interphone System.....	5.30.1
Cabin Interphone System.....	5.30.2
Service Interphone System.....	5.30.2
Passenger Address System.....	5.30.2
<b>Data Link System</b> .....	<b>5.40</b>
Aircraft Communication Addressing and Reporting System (ACARS).....	5.40.1
ACARS Control.....	5.40.1
ACARS Control Through Control Display Units (CDU).....	5.40.1
ACARS Data Mode.....	5.40.2
ACARS Message Display.....	5.40.2
ACARS Voice Mode.....	5.40.2
Online ACARS Voice Mode.....	5.40.3
ACARS Air-to-Ground Voice Calls (Typical).....	5.40.3
ACARS Ground-to-Air Voice Calls (Typical).....	5.40.3
Manual ACARS Override.....	5.40.3
Data Link Related EICAS Messages.....	5.40.3
<b>EICAS Messages</b> .....	<b>5.50</b>
EICAS Communications Alert Messages.....	5.50.1
Crew Communication.....	5.50.1
Selective Calling (SELCAL).....	5.50.1

#### Audio Control Panel

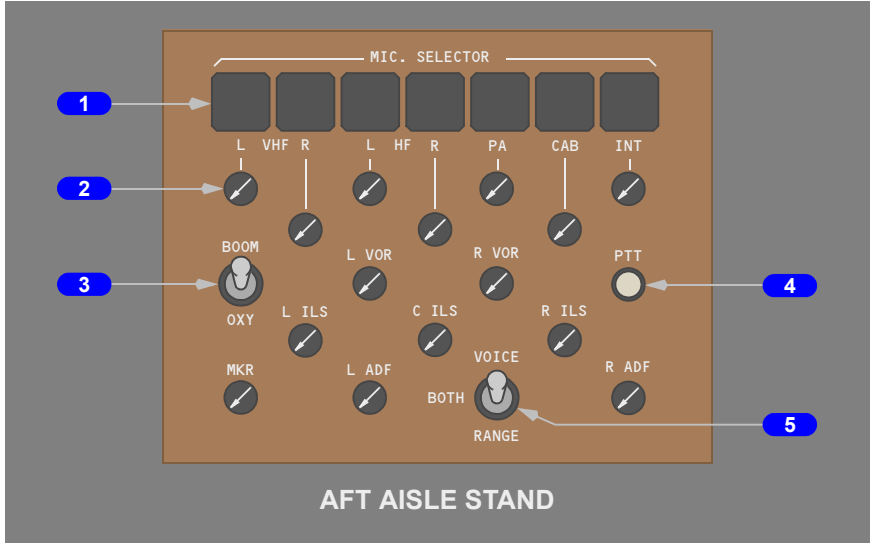

#### 1 Microphone Selector Switches/Lights

Push –

- the selected transmitter light illuminates
- the light for any other transmitter extinguishes
- selects the respective transmitter (radio or intercommunications) for transmission from this crew station (only one can be selected at a time for each crew station)
- selects the receiver audio on, if not already manually selected on

**Note:** INOP placard indicates radio is not installed.

#### 2 Receiver Control

Push – turns respective receiver ON / OFF at any volume setting.

Rotate – varies respective receiver volume.

#### 3 Boom/Oxygen (BOOM/OXY) Switch

BOOM – transmit from the boom microphone.

OXY – transmit from the oxygen mask microphone.

**4 PTT (Push To Talk) Switch**

Push and hold –

- transmits on selected microphone system
- resets illuminated SELCAL lights

**5 NAV Filter Selector**

Filters VOR, ADF, or ILS audio

- VOICE – only voice transmissions can be heard
- BOTH – voice transmissions and station identifiers can be heard
- RANGE – only range audio (station identifiers) can be heard

**Pilot Call Panel**

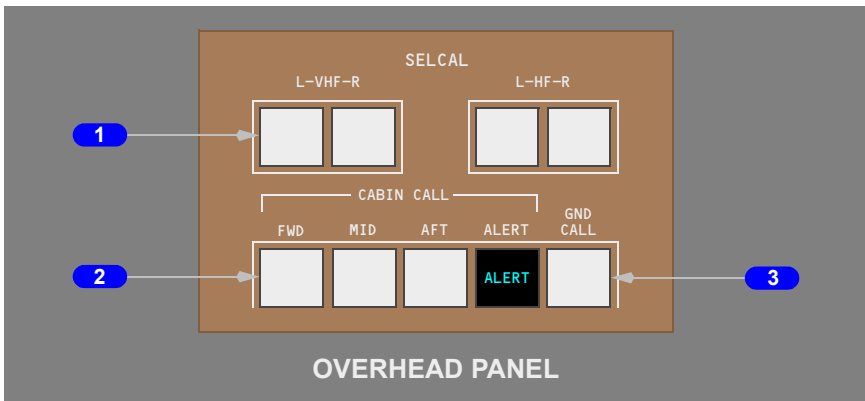

**1 Selective Calling (SELCAL) Switches / Lights**

Illuminated – indicates a radio call on SELCAL

- resets when the respective transmitter is keyed or when light is pushed

**Note:** INOP placard indicates radio is not installed.

**2 CABIN CALL Switch/Lights**

Illuminated – indicates a flight attendant call

- resets when call is answered or cancelled
- FWD, MID, and AFT also reset when light is pushed

Push – calls selected station

- ALERT calls all stations



**3 Ground Call (GND CALL) Switch/Light**

Illuminated – indicates a call from ground personnel.

- extinguishes after 30 seconds

Push – calls ground personnel as long as switch is pushed.

## Radio System

### VHF Communication Panel

Option: VHF radio with 8.33 Mhz spacing

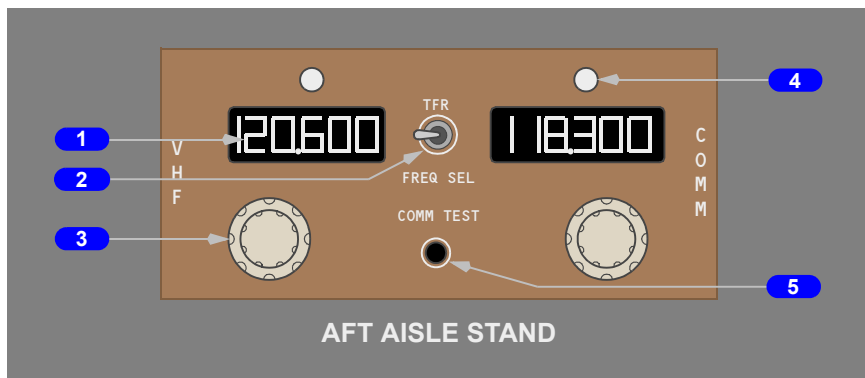

**1 Frequency Window**

Indicates the selected frequency.

**2 Active Frequency Transfer (TFR) Switch**

Selects which frequency is active for the transceiver.

**3 Frequency Selector**

Rotate – changes frequency in window above:

- outer selector changes digits to the left of the decimal point
- inner selector changes digits to the right of the decimal point

**4 Active Frequency Light**

Illuminated – indicates which frequency has been selected by the frequency transfer switch.

**5 COMM TEST Switch**

Push – removes automatic squelch and permits reception of background noise to verify VHF receiver operation.

## HF Communication Panel

### Option: HF radios (single or dual) installed



#### 1 Frequency Window

Indicates the selected frequency.

#### 2 Frequency Selectors

Selects frequency as shown in frequency window.

Rotate left knob – changes the digits to the left of the decimal point.

Rotate right knob – changes the digits to the right of the decimal point.

#### 3 Mode Selector

OFF – power removed from unit.

USB – sets the upper side band (USB) mode.

AM – sets the amplitude modulation (AM) mode.

#### 4 Radio Frequency Sensitivity (RF SENS) Control

Rotate – controls sensitivity of receiver.

- (clockwise) increases sensitivity for reception of weak or distant stations
- (counter clockwise) decreases sensitivity to reduce noise and static

**Note:** decreasing sensitivity too far prevents reception, including SELCAL monitoring of HF radio.

## Miscellaneous Communication Controls

### Control Wheel Microphone/Interphone Switch

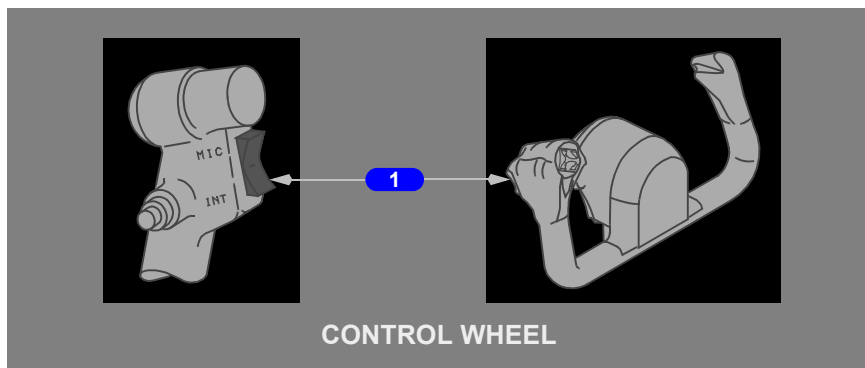

#### **1** Control Wheel Microphone/Interphone (MIC/INT) Switch

MIC – allows transmission on the selected transmitter.

Spring-loaded to center (off) position.

INT – allows transmission on the flight interphone system.

### Service Interphone Switch

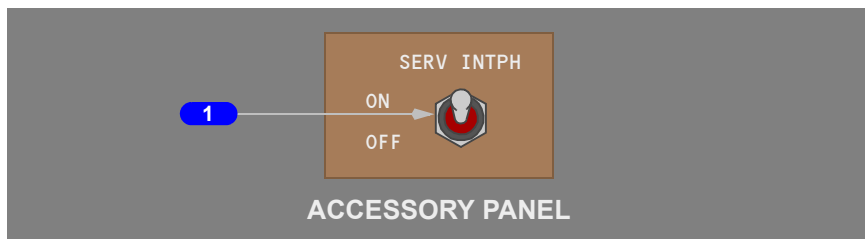

#### **1** Service Interphone (SERV INTPH) Switch

ON – adds external (unpressurized area) headphone jacks to cabin interphone system.

OFF – deactivates external (unpressurized area) headphone jacks, except jack marked FLIGHT at the APU ground control panel.

## Flight Deck Speaker

Options: Speaker with volume control in the center.

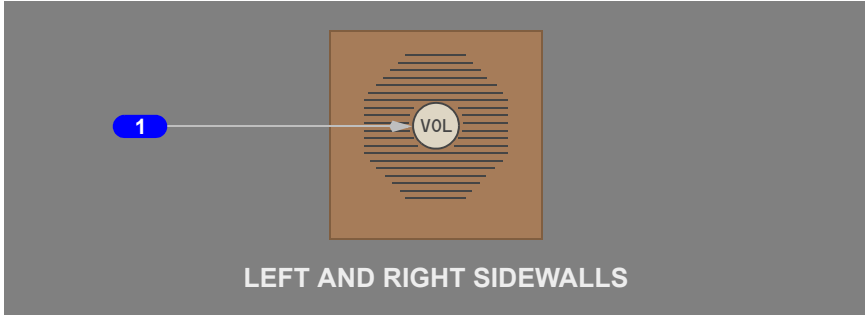

### 1 Flight Deck Speaker Volume Control

Rotate – adjusts speaker volume.

## Captain/First Officer/First Observer Jack Panels



### 1 BOOM MIC (Microphone) Jack

Accepts a flight crew boom microphone plug.

### 2 HEADSET Jack

Accepts a flight crew headset plug.

### 3 HAND MIC (Microphone) Jack

Accepts a flight crew hand microphone plug.

## ACARS or SATCOM Control

### ACARS Access Through Control Display Units (CDU)

Option: ACARS installed

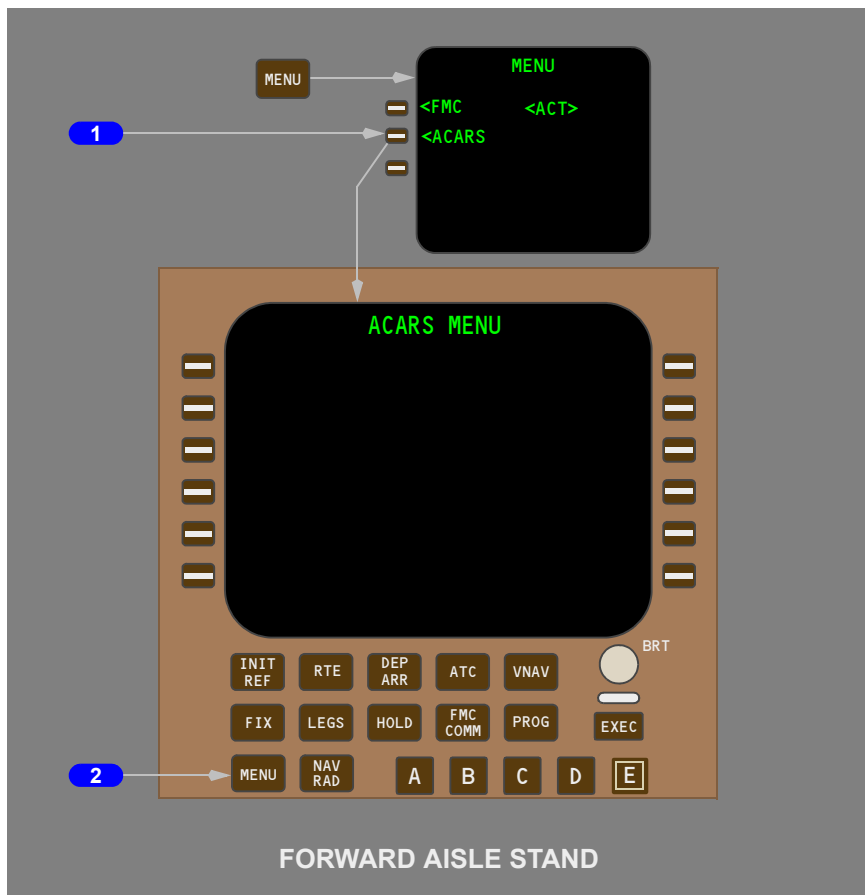

#### 1 ACARS Line Select Key

Push – displays ACARS MENU page.

See section 40 of this chapter for description of ACARS operation.

#### 2 MENU KEY

Push – displays MENU page.

See Chapter 11, Flight Management, Navigation for description of the FMC and associated software functions.

## Cockpit Voice Recorder Panel

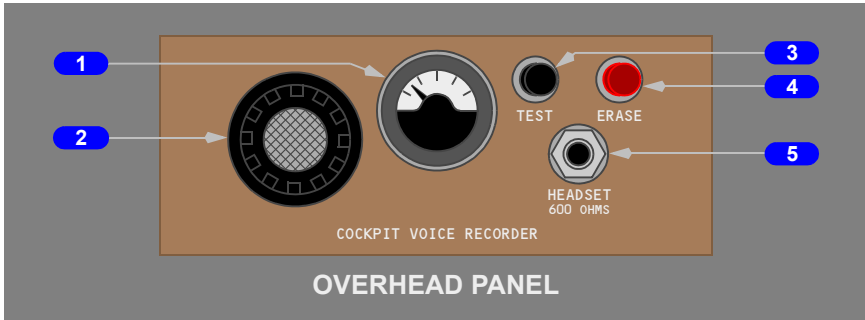

### 1 Monitor Indicator

During test, needle displaces to green band if all four channels are operating.

### 2 Microphone

Detects flight deck area conversations for recording on voice recorder.

### 3 TEST Switch

Push and hold – initiates cockpit voice recorder test.

### 4 ERASE Switch

Push (2 seconds) – erases the voice recorder (if on the ground, AC power on, and the parking brake is set).

### 5 HEADSET Jack

Accepts headset plug to monitor playback voice audio or tone transmission during test.

## Emergency Locator Transmitter

Option: ELT installed

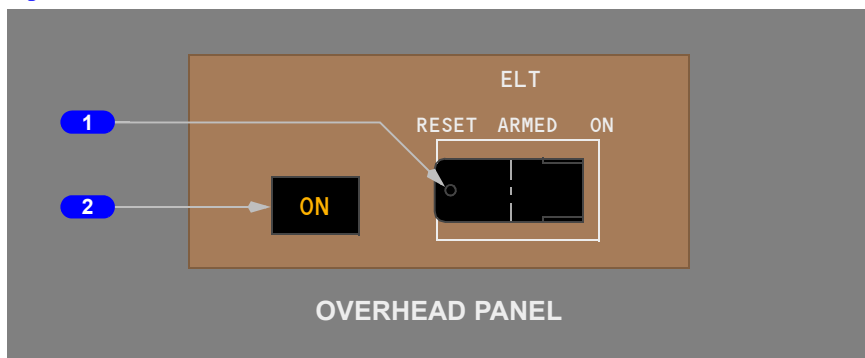

### 1 Emergency Locator Transmitter (ELT) Switch

ON – ELT transmits continuously.

ARMED – ELT starts transmitting if high deceleration is sensed.

RESET (spring loaded to the ARMED position)

- momentary selection (between 1-3 seconds) and release stops ELT transmission
- select and hold starts self-test.

**Note:** The ELT self-test should only be performed by qualified maintenance personnel.

### 2 Emergency Locator Transmitter ON Light

Illuminated (amber) – flashes when ELT is transmitting.

Intentionally  
Blank



---

**Introduction**

The communication systems include:

- radio communication system
- interphone communication system (refer to section 30 of this chapter)
- SELCAL system
- emergency locator transmitter
- cockpit voice recorder system
- communication crew alerting system
- data communication system (refer to section 40 of this chapter)

The communication systems are controlled using the:

- audio control panels (ACP)
- pilot's call panel (PCP)
- communication panels for individual communication radios
- control display unit (CDU) for controlling the data link (refer to section 40 of this chapter)
- emergency locator transmitter (ELT) remote control panel for controlling the fuselage mounted ELT.

---

**Audio Control Panels**

The audio control panels (ACP) are used to manage the radio and interphone communication systems. Navigation receiver audio can also be monitored.

Systems are monitored using headphones or speakers. Receiver volume is controlled on the ACP by rotating the knob beneath the respective receiver.

A speaker volume control is located in the center of the speaker.

Microphones are keyed by pushing the desired ACP transmitter select switch and holding in a PTT (push-to-talk) switch. The PTT switches are located on:

- the control wheels
- the audio control panels
- any hand microphone

There is a boom microphone on the headset, a microphone in the oxygen mask, and a hand microphone jack at all flight crew member stations.

The oxygen mask microphone is enabled and the boom microphone is disabled when the BOOM/OXY switch on the ACP is in the OXY position. Conversely, the oxygen mask microphone is disabled and the boom microphone is enabled when the BOOM/OXY switch is in the BOOM position.

---

---

## Radio Communication Systems

The radio communication systems consist of:

- the high frequency (HF) communication system
- the very high frequency (VHF) communication system
- the selective calling (SELCAL) system

### HF Communication System

#### **Option: HF radios (single or dual) installed**

Two independent HF communication radios are installed. These are designated HF L (left) and HF R (right). The ACPs are used to control voice transmission and receiver monitoring.

The HF radios are tuned on a dedicated communication panel for each radio.

To tune an HF radio, rotate the frequency selectors on the communications panel. The left knob changes the digits to the left of the decimal point, and the right knob changes the digits to the right of the decimal point.

The HF radio sensitivity can be adjusted by rotating the RF SENS control knob. Rotating clockwise increases the sensitivity to receive weak or distant stations. Rotating counter clockwise decreases the sensitivity to decrease noise and static.

**Note:** Decreasing sensitivity too far prevents reception, including SELCAL monitoring of the HF radio.

Both HF radios use a common antenna. When either HF radio is transmitting, the antenna is disconnected from the other HF radio, and it cannot be used to transmit or receive. However, both HF radios can receive simultaneously if neither is being used for transmitting.

When an HF transmitter is keyed after a frequency change, the antenna coupler tunes. While the antenna is being tuned, a tone can be heard through the audio system (tuning takes a maximum of 15 seconds).

### VHF Communication System

Three independent VHF radios are installed, designated VHF L (left), VHF C (center), and VHF R (right). The ACPs are used to control voice transmission and receiver monitoring.

The VHF radios are tuned on a dedicated communications panel for each radio.

Each VHF radio allows the tuning of two independent frequencies, an active and a standby frequency. These can be interchanged with the frequency transfer switch. The ACPs are used to control voice transmission and receiver monitoring.

---

## Selective Calling (SELCAL) System

The SELCAL system monitors all of the radios. When the system receives a properly encoded call from a ground station, the crew is alerted through the illumination of the corresponding light on the pilots call panel.

The flight crew is also alerted to an incoming call by an aural chime and the •SELCAL communication message on EICAS.

---

## Aircraft Communication Addressing and Reporting System (ACARS)

### Option: ACARS installed

ACARS provides an automatic or manual means to transmit and receive operational, maintenance, and administrative information between the airplane and a ground station. ACARS is operational when electrical power is established. The ACARS systems descriptions provided in this section are limited to manual selection of ACARS radio operating modes. Refer to section 40 of this chapter for additional information about ACARS operation and control.

ACARS communicates incoming and outgoing data and messages through:

- the center VHF radio

ACARS provides for automatic and manual control, including mode selection, of the dedicated ACARS radio through the ACARS management unit. Refer to section 40 of this chapter for description of this function.

The dedicated ACARS radio is normally operated in data mode for automatic transmission of data and message traffic. In the data mode, the radio is controlled by the ACARS management unit. The flight crew should ensure that the ACARS radio is in data mode with an appropriate data frequency selected. An offline voice mode is also available for regular voice communications.

---

## Voice Recorder System

The cockpit voice recorder records any transmitted or received flight deck audio as selected on the audio control panels. It also records flight deck area conversations using an area microphone. All inputs are recorded continuously when electrical power is applied to the airplane.

## Fuselage Mounted Emergency Locator Transmitter (ELT)

### Option: ELT installed

An emergency locator transmitter (ELT) is mounted to the top center of the fuselage in the passenger cabin area. The ELT automatically transmits distress signals on 121.5 MHZ, 243 MHZ, and 406 MHZ if a high deceleration is sensed, or if the ELT switch is positioned to ON.

## Communication Crew Alerting System

### Option: EICAS 1001 computer installed

The communication crew alerting system provides a method of notifying the flight crew about incoming calls from the cabin, ground personnel, or an incoming radio call by displaying messages on the EICAS system.

## Crew Communications Messages

The communication crew alerting system provides aural and visual alerts for normal operations requiring crew awareness that may require crew action. Visual alerts are presented as communication level messages preceded by a white bullet symbol (•). The aural alert is a single chime. The flight crew should respond to communication alert messages by establishing interphone communications with the calling station. Refer to section 50 of this chapter for a list of possible messages.

## Communication Alert Categories

The following table shows communication crew alert categories and the respective aural and visual alerts for each category.

Alert Category	Aural	Visual	Remarks
Medium	Chime	EICAS communication alert. Illumination of appropriate switch/light on the PCP or ACP.	Message awareness required. Crew action may be required.
Low	None	EICAS communication alert.	Crew action may be required.

## Selective Calling (SELCAL) Messages

The communication crew alerting system also provides a supplementary method of notifying the flight crew about incoming calls from the cabin, ground personnel, or an incoming radio call. The •SELCAL message is a medium category alert. The flight crew should respond by establishing interphone communications with the calling station or transmitting on the corresponding radio. Added note regarding the ELT maintenance self-test function.

Intentionally  
Blank

**Interphone Communication System**

The interphone communication system includes the:

- flight interphone system
- cabin interphone system
- service interphone system
- passenger address (PA) system

The interphone systems allow the flight crew to communicate with the flight attendants, ground personnel, or maintenance technicians. The PA system allows flight attendants or the flight crew to make announcements in the passenger cabin.

The flight interphone, service interphone, cabin interphone, and passenger address systems are normally operated through the audio control panel (ACP) in conjunction with the pilot call panel (PCP).

**Flight Interphone System**

The flight interphone system (FIS) permits intercommunication between flight deck crew members and, on the ground, with ground personnel.

The system is used by the following methods:

- pressing the interphone (INT) position of a control wheel mic/interphone switch to transmit
- selecting interphone (INT) transmitter select switch on the ACP and pushing a PTT switch

Ground personnel are able to communicate on the FIS through a jack located on the APU ground control panel mounted on the nose wheel strut.

The pilots are alerted to an incoming call from the ground crew by the following methods:

- an aural chime sounds in the flight deck
- the GND CALL light on the PCP illuminates
- the EICAS message •GROUND CALL is displayed

The flight crew should respond to the call using the FIS. Any of the PTT switches may be used to communicate.

The flight crew initiates a call to ground personnel by pushing the GND CALL switch on the PCP. A horn in the nose wheel well activates as long as the switch is pushed. Communication can then take place over the FIS.

## Cabin Interphone System

The cabin interphone system (CIS) provides voice communications between the flight deck and the flight attendant stations. Flight deck crew members communicate on the CIS using their ACP and the PCP. The flight crew may use the boom microphones, oxygen mask microphones, or hand microphones to transmit.

A call can be placed by selecting the CABIN transmitter select switch on an audio control panel, selecting the appropriate (FWD, MID, AFT, or ALERT) station on the PCP, and pressing the PTT switch to speak when the call is answered.

When the call is answered, it may be heard on the flight deck speaker or on the headset.

The pilots are alerted to incoming calls from the cabin by the following methods:

- an aural chime in the flight deck
- a light (FWD, MID, AFT, or ALERT) illuminates on the PCP
- EICAS communications messages •CABIN ALERT or •CABIN CALL

The ALERT function calls all other interior stations simultaneously. The ALERT is initiated by pressing the ALERT switch on the PCP which will illuminate the call lights and sound the chime at all interior stations except for the originating station. Alert calls automatically override other cabin interphone calls.

Calls to the flight deck can be answered by selecting CABIN on the audio control panel and transmitting using the interphone (INT) switch on the control wheel, or any other PTT switch.

## Service Interphone System

The service interphone system consists of additional internal and external jacks connected to the flight/cabin interphone system for use by maintenance personnel. To reduce external noise in the flight/cabin interphone system, the service interphone switch can be left OFF during normal flight operations. This disconnects the microphone jacks at all exterior (unpressurized) service interphone stations except the jack on the nose wheel strut. This switch does not affect the interior flight/cabin interphone stations.

## Passenger Address System

The passenger address (PA) system allows flight deck crew members and flight attendants to make announcements throughout the cabin. Flight deck crew members can make announcements with any microphone by pushing the PA transmitter select switch on an audio control panel. Then, pressing any of the PTT switches will key the system for PA announcements.



The system is monitored on the flight deck by pushing the PA receiver volume control on an audio control panel and adjusting the volume. This will adjust the audio volume to the flight crew headset only. It does not adjust the volume of the output broadcast over the PA system.

The cabin PA announcement priorities are:

- flight deck announcements
- cabin announcements made from a flight attendant station
- pre-recorded announcement
- boarding music

PA announcements from any station override all passenger cabin pre-recorded announcements and passenger entertainment outputs.

Intentionally  
Blank

---

## **Aircraft Communication Addressing and Reporting System (ACARS)**

The Aircraft Communications Addressing and Reporting System (ACARS) is a digital data link communication system designed to automatically enable various on-board systems to communicate data between the airplane and a network of ground stations.

The primary airborne system component is the ACARS management unit (MU). The MU provides the central clock, memory, and data processor for ACARS. For airborne event sensing and flight crew alerting, the MU interfaces with:

- the EICAS computers
- the SELCAL system

The ACARS MU collects, controls, and processes incoming and outgoing data and messages through:

- the VHF radio system

The dedicated ACARS radio is normally operated in data mode for automatic transmission of data and message traffic. Refer to section 20 of this chapter for a description of the ACARS capable VHF or HF radio systems.

---

## **ACARS Control**

Flight crew access to ACARS control is through:

- the control display units (CDU)

ACARS installations include airline modifiable buyer furnished equipment (BFE). The ACARS system descriptions and menu page illustrations presented represent typical installations. Airline configuration of BFE equipment can make significant changes in operational menus which are not presented here.

### **ACARS Control Through Control Display Units (CDU)**

Flight crew access to ACARS is through a control display unit (CDU). Selecting the line select key adjacent to the <ACARS prompt will call up the ACARS Main Menu Page. From this page all ACARS functions may be accessed, such as pre-flight initialization, systems status checks, ACARS radio control, message status or display, printer functions, and ACARS configuration.

The specific software providing ACARS functionality is defined by the airline and is not covered here.

## **ACARS Data Mode**

ACARS is normally operated in the data mode, allowing automatic transmission of routine reports, engine and performance data. In data mode, the system monitors and stores the times of the following events:

- OUT – airplane departure from the gate, based on customer defined parameters (e.g. closure of all passenger entry doors and parking brake released)
- OFF – takeoff (main gear tilted)
- ON – landing (main gear not tilted)
- IN – airplane arrival at destination gate, based on customer defined parameters (e.g. parking brake set and at least one passenger entry door open)

The system automatically transmits OOOI events at occurrence. In data mode, the MU automatically tunes the ACARS dedicated radio to a standard link frequency. ACARS monitors this frequency for messages addressed to that airplane as well as sending messages to the ground.

In addition to transmitting routine data automatically, ACARS allows manual data entry for subsequent transmission to ground stations. Engine parameters, fuel status, and other information can be conveyed to a ground station by entering values on the appropriate page and pressing the SEND key.

Pre-flight data such as flight number, fuel on board, and departure/destination station can be entered in the ACARS system manually, or received by data uplink.

## **ACARS Message Display**

ACARS messages to or from the airplane can be displayed on the CDU through the STORED MESSAGES pages. Message titles appear in large characters until displayed. Messages can be sent to the printer by pressing the PRINT line select key.

---

## **ACARS Voice Mode**

The ACARS system provides a voice mode to facilitate voice communications between the airplane and groundstations. The ACARS system descriptions presented are general in scope and represent typical installations. Airline configuration of BFE equipment can make significant changes in operational menus which are not presented here.

## **Online ACARS Voice Mode**

Online voice mode provides an ARINC compatible communication link to ground based telephone systems. ACARS voice mode communications are initiated either from the airplane or the ground. When online voice mode is initiated the ACARS MU will continue to compile, but not transmit, data and message traffic. The MU will notify the flight crew whenever voice mode operations exceed two minutes.

### **ACARS Air-to-Ground Voice Calls (Typical)**

To initiate an ACARS voice call, use the ACARS menu pages and request the call. The applicable phone number is automatically dialed with the downlink request and voice mode is automatically selected when the call is connected. When the call is connected, the ACARS system will annunciate the call with an aural chime and the appropriate SELCAL switchlight on the PCP or ACP (VHF C or VHF R) will illuminate.

To complete the call push the applicable microphone selector switch on the ACP and adjust the volume (if required). Push a push-to-talk (PTT) switch for microphone operation. Use a boom microphone headset or other flight interphone system to speak and listen to the call. When the call is stopped the MU will automatically return to data mode.

### **ACARS Ground-to-Air Voice Calls (Typical)**

When an ACARS voice radio communication is received, the corresponding SELCAL light illuminates and an aural chime sounds on the flight deck. Received calls are automatically connected. ACARS voice mode is automatically selected and does not require flight crew action from the ACARS menu pages. To receive a call push the illuminated VHF C or VHF R microphone selector switch on the ACP, push a PTT switch, and begin the call.

The flight crew may also respond to a ground initiated voice call by selecting the appropriate responses on the ACARS menu pages and pushing the illuminated CALL microphone selector switch on the ACP.

### **Manual ACARS Override**

Manually tuning the ACARS dedicated radio to a normal voice frequency or deselecting data mode places that VHF or HF radio into voice mode.

Refer to section 20 of this chapter, Systems Description, for the operation and control of ACARS compatible radios or ACARS manual override provisions.

---

## **Data Link Related EICAS Messages**

Intentionally  
Blank

**EICAS Communications Alert Messages**

This section describes the various EICAS communication alert messages that can be displayed.

**Crew Communication**

<b>Message</b>	<b>Level</b>	<b>Condition</b>	<b>Crew Action/Remarks</b>
• CABIN ALERT	Medium	Pilot alert received over cabin interphone.	Respond to the alert. Message accompanied by aural chime and ALERT cabin call light.
• CABIN CALL	Medium	Pilot call received over cabin interphone.	Respond to the call. Message accompanied by aural chime and FWD/MID/AFT cabin call light.
• GROUND CALL	Medium	Pilot call received from the nose wheel well over the flight interphone.	Respond to the call. Message accompanied by aural chime and GND CALL light.

**Selective Calling (SELCAL)**

<b>Message</b>	<b>Level</b>	<b>Condition</b>	<b>Crew Action/Remarks</b>
• SELCAL	Medium	SELCAL received on VHF or HF radio.	Determine which radio received call. Respond to the call. Message is accompanied by aural chime and VHF/HF SELCAL light.

Intentionally  
Blank



**Controls and Indicators . . . . . 6.10**

- Electrical Panel . . . . . 6.10.1
- Battery/Standby Control Panel. . . . . 6.10.3
- Hydraulic Generator Test Switch. . . . . 6.10.4

**System Description . . . . . 6.20**

- Introduction . . . . . 6.20.1
- AC Electrical System. . . . . 6.20.1
  - AC Electrical System Power Sources. . . . . 6.20.1
  - AC Electrical Power Distribution. . . . . 6.20.2
  - AC Electrical System Schematic (Hydraulic Driven Generator) . . . . . 6.20.5
- DC Electrical System. . . . . 6.20.6
  - DC Electrical System Schematic . . . . . 6.20.7
- Battery/Standby Power System . . . . . 6.20.8
  - Hot Battery Bus . . . . . 6.20.8
  - Battery Bus . . . . . 6.20.8
  - Standby DC Bus . . . . . 6.20.8
  - Standby AC Bus . . . . . 6.20.9
- Battery/Standby System Schematic . . . . . 6.20.10
- Hydraulic Driven Generator. . . . . 6.20.11
- Battery/Standby System Schematic (Hydraulic Driven Generator Operating) . . . . . 6.20.12

**EICAS Messages. . . . . 6.30**

- Electrical EICAS Messages . . . . . 6.30.1

Intentionally  
Blank

#### Electrical Panel

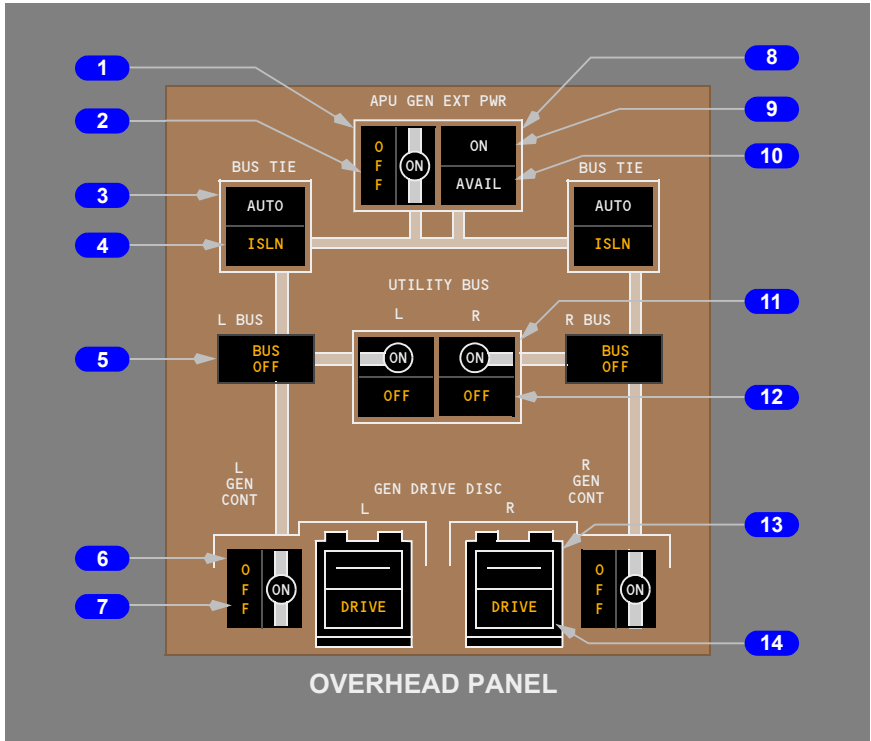

#### 1 APU Generator (APU GEN) Control Switch

ON (bar in view) –

- arms APU generator control breaker to close automatically.

OFF (bar not visible) –

- opens APU generator control breaker
- resets fault trip circuitry.

#### 2 APU Generator OFF Light

Illuminated (amber) –

- the APU generator control breaker is open because of a fault with APU running
- the APU generator control switch is selected OFF.

### **3 BUS TIE Switches**

AUTO –

- arms automatic AC bus tie circuits
- arms automatic DC bus tie circuits
- arms automatic flight instrument transfer bus circuits.

OFF (AUTO not visible) –

- commands the AC bus tie open
- commands the DC bus tie open
- commands the flight instrument bus tie open
- resets fault trip circuitry.

### **4 AC Bus Isolation (ISLN) Lights**

Illuminated (amber) –

- a fault has occurred, automatically opening the AC bus tie breaker
- the BUS TIE switch is OFF.

### **5 AC BUS OFF Lights**

Illuminated (amber) – the AC bus is unpowered.

### **6 Generator Control (GEN CONT) Switches**

ON (bar in view) – arms the generator control breaker to close automatically when generator power is available.

OFF (bar not visible)

- opens generator control breaker
- resets fault trip circuitry.

### **7 Generator OFF Lights**

Illuminated (amber) – the generator control breaker is open.

### **8 External Power (EXT PWR) Switch**

Push – if AVAIL light is illuminated, closes external power contactor

Subsequent push – opens external power contactor.

### **9 External Power ON Light**

Illuminated (white) – external power is powering the bus(es).

**10 External Power Available (AVAIL) Light**

Illuminated (white) – external power is plugged in and power quality is acceptable.

**11 UTILITY BUS Switches**

ON (bar in view) – if no load shed signal is present, connects utility and galley busses to main AC bus.

OFF (bar not visible) –

- disconnects utility and galley busses from main AC bus
- resets overload load shed circuitry.

**12 Utility Bus OFF Lights**

Illuminated (amber) – the utility and galley busses are unpowered.

**13 Generator Drive Disconnect (GEN DRIVE DISC) Switches**

Push –

- disconnects generator drive from the engine
- requires maintenance action on the ground to reconnect the generator drive.

**14 Generator DRIVE Lights**

Illuminated (amber) –

- the generator drive oil temperature is high
- the generator drive oil pressure is low.

**Battery/Standby Control Panel**

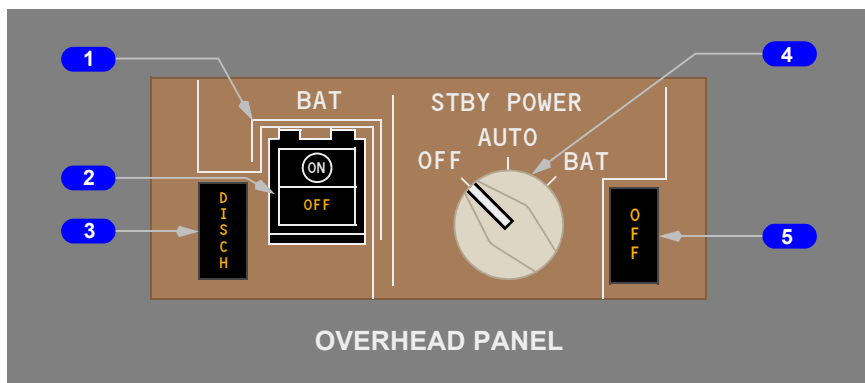

---

**1 Battery (BAT) Switch**

ON –

- Unpowered airplane on the ground:
  - a few annunciator lights illuminate
  - allows the APU to be started
- Powered airplane in flight or on the ground when AC power is removed or lost:
  - the standby and battery busses are powered.

OFF (ON not visible) – turns battery power off.

**2 Battery OFF Light**

Illuminated (amber) – the battery switch is off.

**3 Battery Discharge (DISCH) Light**

Illuminated (amber) – the main battery is discharging.

**4 Standby (STBY) POWER Selector –**

OFF – the standby busses are unpowered.

AUTO – the standby busses transfer to battery power if normal AC power is lost.

BAT – the standby busses are powered from the main battery.

**5 Standby Power Bus OFF Light**

Illuminated (amber) – standby AC or DC bus not powered.

---

**Hydraulic Generator Test Switch**

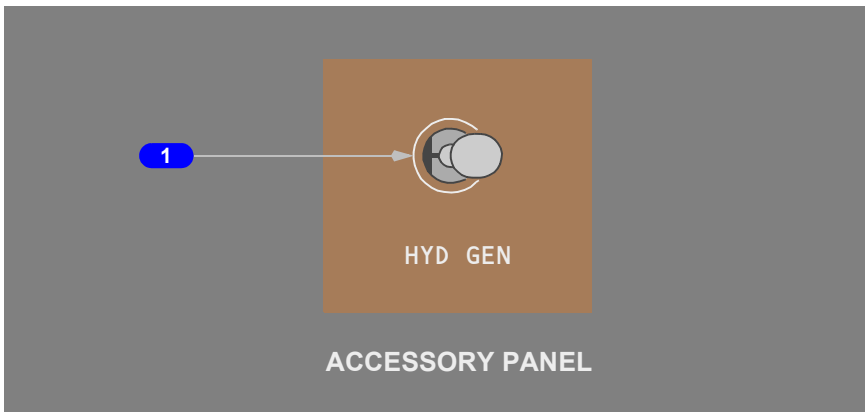

**1 Hydraulic Generator Test Switch**

Spring-loaded to center.

HYD GEN – initiates hydraulic driven generator system test.

Intentionally  
Blank



**Introduction**

The electrical system generates and distributes AC and DC power to other airplane systems, and is comprised of: main AC power, main DC power, battery/standby power, and the hydraulic driven generator. System operation is automatic. Electrical faults are automatically detected and isolated.

**AC Electrical System**

The AC electrical system is the main source for airplane electrical power.

**AC Electrical System Power Sources**

The entire airplane AC electrical load can be supplied by any two main airplane AC power sources.

The main airplane AC electrical power sources are:

- left and right engine integrated drive generators (IDGs)
- APU generator.

The entire airplane AC electrical load also can be supplied by external power.

The power sources operate isolated from one another.

**Integrated Drive Generators (IDGs)**

Each engine has an IDG. Each IDG has automatic control and system protection functions.

When an engine starts, with the GENERATOR CONTROL switch selected ON, the IDG automatically powers the respective main bus. The previous power source is disconnected from that bus.

The IDG can be electrically disconnected from the busses by pushing the GEN CTRL switch to OFF. The IDG can also be electrically disconnected from its respective bus by selecting external power prior to engine shutdown. (See External Power in this section.) The OFF light in the GEN CTRL switch illuminates, and the EICAS Advisory message L or R GEN OFF displays whenever the generator control breaker is open.

The DRIVE light illuminates and the EICAS Advisory message L or R GEN DRIVE displays when low oil pressure or high oil temperature is detected in an IDG. The IDG drive can be disconnected from the engine by pushing the respective DRIVE DISC switch. The IDG cannot be reconnected by the flight crew.

## **APU Generator**

The APU generator is electrically identical to the IDG generators. The APU generator can power either or both main busses, and may be used in flight as a replacement to an IDG source.

If no other power source is available when the APU generator becomes available, the APU generator automatically connects to both main AC busses. If the external source is powering both main busses, the external source continues to power both main busses.

The APU Generator OFF light illuminates, and the EICAS advisory message APU GEN OFF displays when the APU is operating and the APU generator control breaker is open because of a fault or the APU GEN switch is selected OFF. When the APU GENERATOR switch is ON and a fault is detected, the APU generator cannot connect to the busses.

## **External Power**

External power can power the left and right main busses. When the power source voltage and frequency are within limits, the external power AVAIL light illuminates.

Pushing the EXT PWR switch ON connects external power to both main busses and removes the IDGs and the APU generator from the busses, if they were powering the busses. When external power is connected to a main bus, the EXTERNAL POWER ON light illuminates.

## **AC Electrical Power Distribution**

AC power is distributed through the left and right main busses and the ground service bus.

### **AC Main Busses**

The right IDG normally powers the right main bus and the left IDG normally powers the left main bus. The APU normally powers both main busses when they are not powered by any other source. External power may also be connected and will also power both main busses.

Bus tie breakers, controlled by BUS TIE switches, isolate or parallel the right and left main busses. When both BUS TIE switches are set to AUTO, the bus tie system operates automatically to maintain power to both main busses.

The AC bus ISLN light illuminates and the EICAS advisory message L or R BUS ISOLATED displays when the bus tie breaker is open because of a fault or the BUS TIE switch is OFF.

The BUS OFF light illuminates and the EICAS caution message L or R AC BUS OFF displays if an AC bus is unpowered.

---

The source order for powering left and right main busses is the:

- respective IDG
- APU generator
- opposite IDG.

### **Utility busses**

Left and right utility busses, powered by their respective main AC bus, are controlled by UTILITY BUS switches. Left and right galley busses are powered by their respective utility busses, and have no direct controls or indicators. The utility bus OFF lights illuminate and the EICAS advisory message L or R UTIL BUS OFF displays when a galley and utility bus are unpowered.

### **Ground Service Bus**

The ground service bus is normally powered by the right main bus. Alternate sources of power for the ground service bus are:

- the APU generator
- external power.

The ground service bus powers:

- the main battery charger
- the APU battery charger
- miscellaneous cabin and system loads.

### **Ground Handling Bus**

The ground handling bus can be powered only on the ground and only from the APU generator or from the external power source. It is provided for loads such as cargo handling and equipment energized only during ground operations.

### **Autoland**

During autoland, the busses isolate to allow three independent sources to power the three autopilots:

- the left main system powers the left autopilot and the captain's flight instrument transfer bus
- the right main system powers the right autopilot and the first officer's flight instrument transfer bus
- the battery/standby system powers the center autopilot.

Above 200 feet, loss of a generator results in:

- both bus tie breakers closing and the operating generator powers both left and right AC busses
- the left main system powers the center autopilot
- NO LAND 3 appears on the Autoland Status Annunciator.

Below 200 feet, loss of a generator results in:

- both bus tie breakers remaining open
- the autopilot associated with a failed generator is unpowered

- 
- the flight instruments remain powered through the flight instrument transfer busses
  - the autoland continues using the remaining two autopilots.

When the autopilots are disengaged or an autopilot go-around is performed, the electrical system reverts to normal, non-isolated operation.

### **Flight Instrument Transfer Busses**

Normally, the captain's flight instruments are powered by the left main AC Bus, and the first officer's flight instruments are powered by the right main AC Bus. If the respective bus tie breakers are in AUTO, the flight instrument transfer busses transfer to the opposite main AC bus in the event power is lost to a main AC Bus.

If power is lost to both main AC busses, the captain's flight instruments are powered by the hydraulic driven generator.

### **Electrical Load Shedding**

Electrical load shedding occurs automatically to ensure power is available to critical and essential equipment.

If the electrical loads exceed the power available, the electrical system automatically sheds AC loads by priority until the loads are within the capacity of the generators. The load shedding is galley power first, then utility busses. Utility busses are followed by individual equipment items powered by the main AC busses. When an additional power source becomes available or the load decreases, the electrical system automatically restores power to the shed systems (in the reverse order).

Examples of load shedding that may be observed in the flight deck or cabin during normal operations include:

- an electric hydraulic pump prior to engine start
- center tank fuel pumps prior to engine start
- utility busses during engine start.

Examples of load shedding that may be observed in the flight deck or cabin during non-normal operations include:

- utility busses after a generator failure
- center tank fuel pump after an engine failure
- cabin ceiling lights after an engine failure.

On the ground, advancing the thrust levers into the takeoff range with the engines shut down may cause inadvertent load shedding of the utility busses to occur. Returning the thrust levers to idle, then pushing the UTILITY BUS switches OFF, then ON will reset this inadvertent load shedding.

**AC Electrical System Schematic (Hydraulic Driven Generator)**

Electrical system shown with the optional hydraulic driven generator.

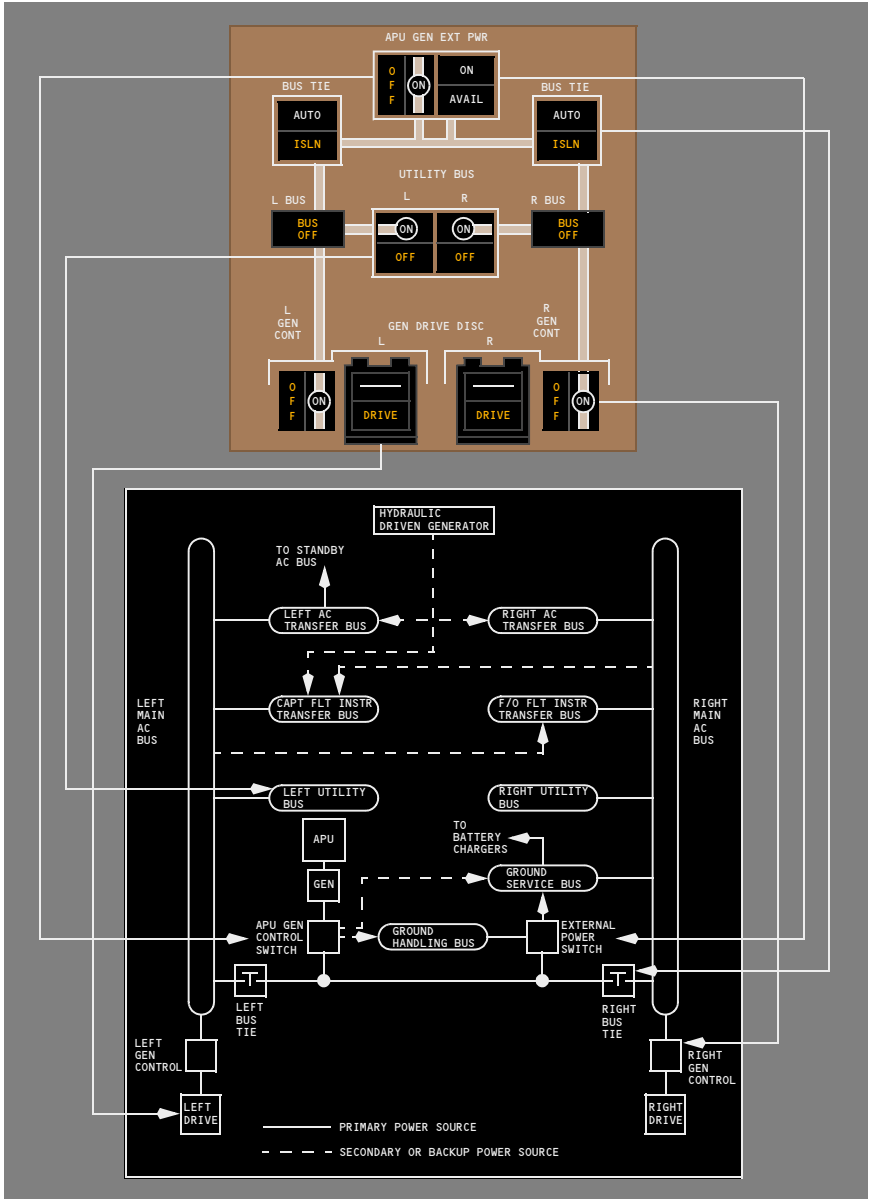

## **DC Electrical System**

The main DC electrical system uses transformer–rectifier units (TRUs) to produce DC power. The TRUs are powered by the main AC busses.

The TRUs operate isolated from one another. If one TRU fails, the DC bus tie breaker closes to keep both DC busses powered. Both BUS TIE switches must be in AUTO for the DC bus tie breaker to close.

There are no flight deck controls for the main DC electrical system.

**DC Electrical System Schematic**

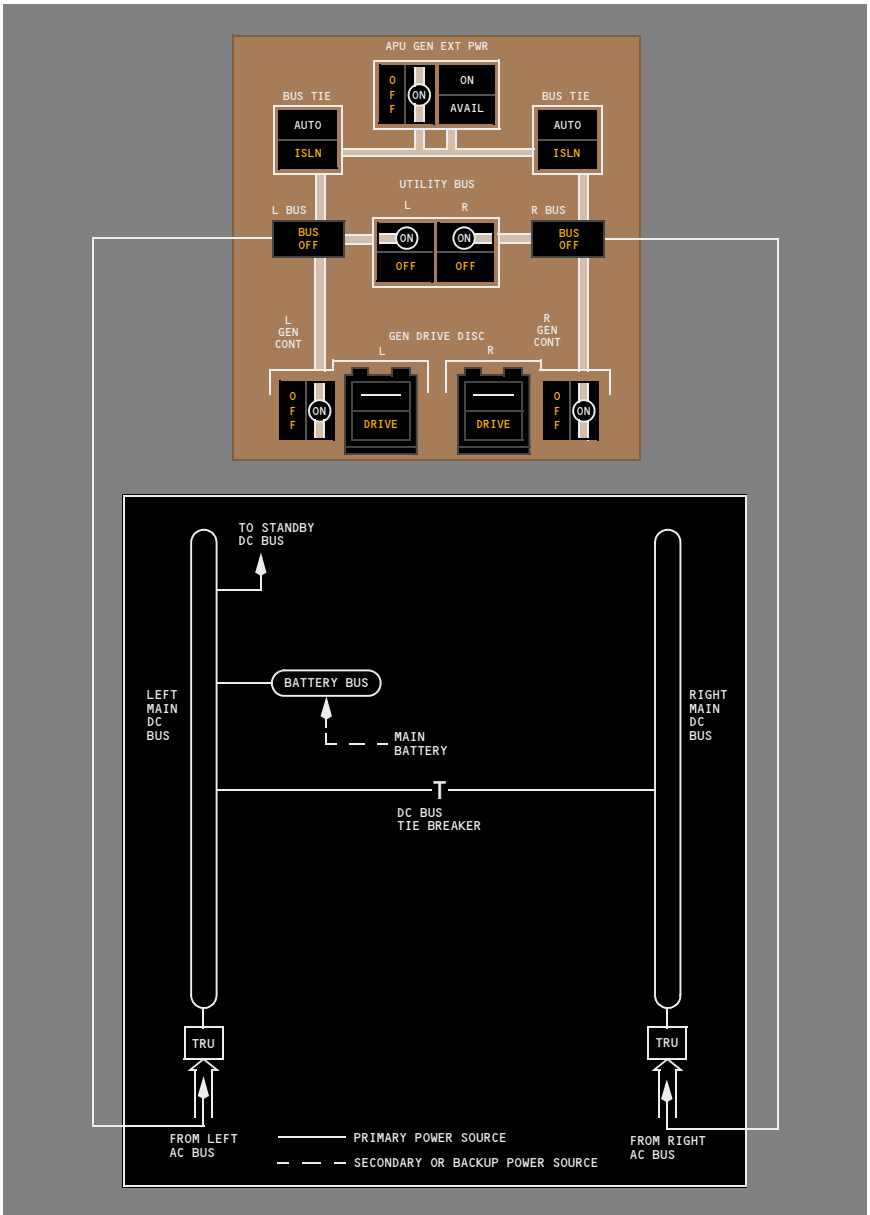

---

---

## Battery/Standby Power System

The battery/standby power electrical system can supply DC and AC power to selected flight instruments, communications and navigation systems, and other critical systems, if there are main AC and DC electrical power system failures.

The Battery/Standby Power System consists of the following busses:

- the hot battery bus
- the battery bus
- the standby DC bus
- the standby AC bus

### Hot Battery Bus

The hot battery bus provides power to items which must be continuously powered, such as the clock's time reference.

Prior to establishing electrical power, the main battery powers the hot battery bus. After establishing electrical power, the main battery charger powers the hot battery bus.

### Battery Bus

Prior to establishing electrical power, when the battery switch is ON, the main battery powers the battery bus.

After establishing electrical power, the left DC system powers the battery bus, and the main battery provides a backup source of power.

The Battery DISCH light illuminates when the main battery is discharging. If EICAS is powered, the advisory message MAIN BAT DISCH also displays.

The battery OFF light illuminates and the EICAS advisory message BATTERY OFF displays if the battery switch is OFF after electrical power is established.

### Standby DC Bus

The Standby DC Bus can be powered by several sources. Prior to establishing electrical power, when the battery switch is ON and the standby power selector is in AUTO, the main battery powers the standby DC bus. The Battery DISCH light illuminates when the main battery is discharging. After establishing electrical power, the left DC system powers the standby DC bus and the main battery provides a backup source of power. When the standby power selector is in BAT, the main battery powers the standby DC bus.

The standby bus OFF light illuminates and the EICAS advisory message STANDBY BUS OFF displays if the standby DC bus is unpowered.



---

## Standby AC Bus

The Standby AC bus can be powered by several sources. Prior to establishing electrical power, when the battery switch is ON and the standby power selector is in AUTO, the main battery powers the standby inverter which provides AC power to the standby AC bus. After establishing electrical power, the left AC system powers the standby AC bus and the main battery and standby inverter provide a backup source of power. When the standby power selector is in BAT, the main battery and standby inverter power the standby AC bus.

The standby bus OFF light illuminates and the EICAS advisory message STANDBY BUS OFF displays if the standby AC bus is unpowered.

**Battery/Standby System Schematic**

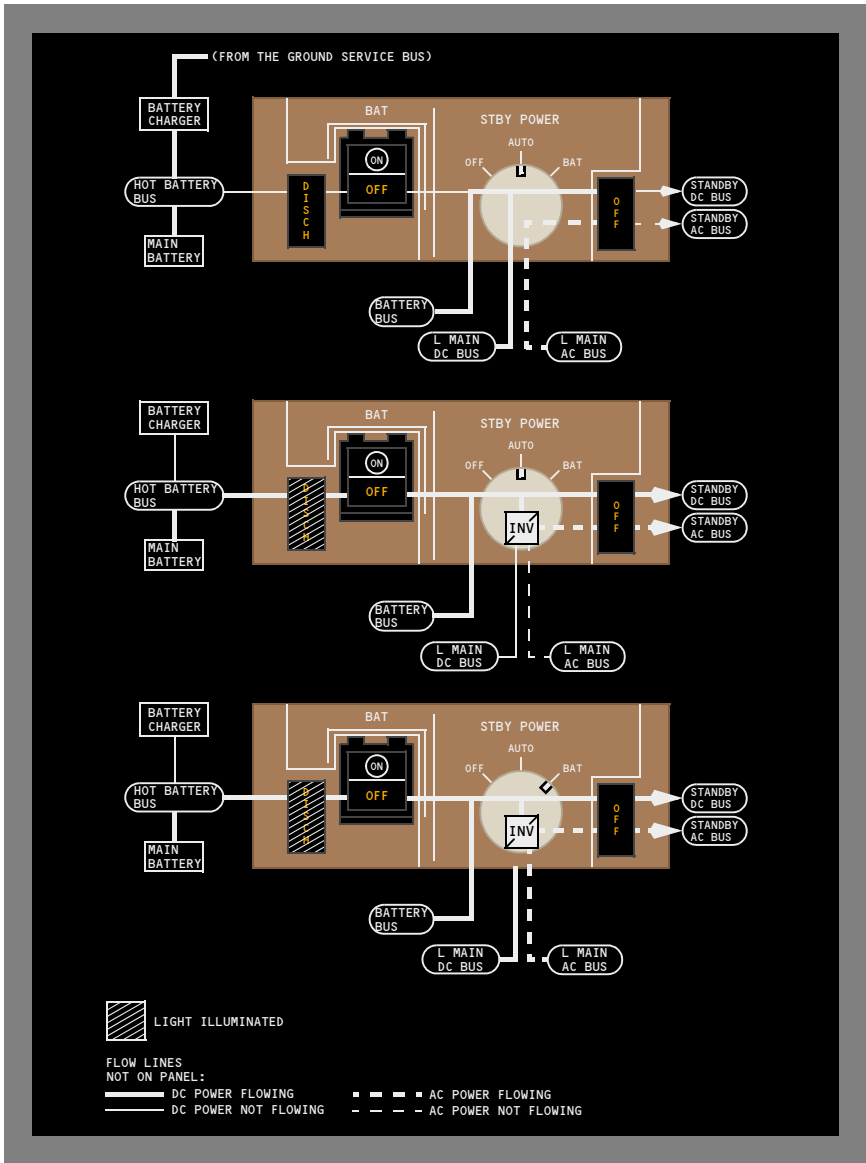

---

---

## Hydraulic Driven Generator

### When equipped with the optional hydraulic driven generator.

The hydraulic driven generator (HDG) activates automatically when both the left and right main AC busses are unpowered. The hydraulic driven generator is powered by the left hydraulic system.

The hydraulic driven generator provides AC power to:

- the left AC transfer bus
- the right AC transfer bus
- the standby AC bus (through the left AC transfer bus)
- the captain's flight instrument transfer bus

The hydraulic driven generator provides DC power to:

- the hot battery bus
- the battery bus
- the standby DC bus

The amount of DC power produced by the hydraulic driven generator is less than the DC power produced by a fully charged battery. When the hydraulic driven generator first begins to operate, the battery DISCH light may illuminate until the battery power decreases to the power level produced by the hydraulic driven generator.

## Battery/Standby System Schematic (Hydraulic Driven Generator Operating)

When equipped with the optional hydraulic driven generator.

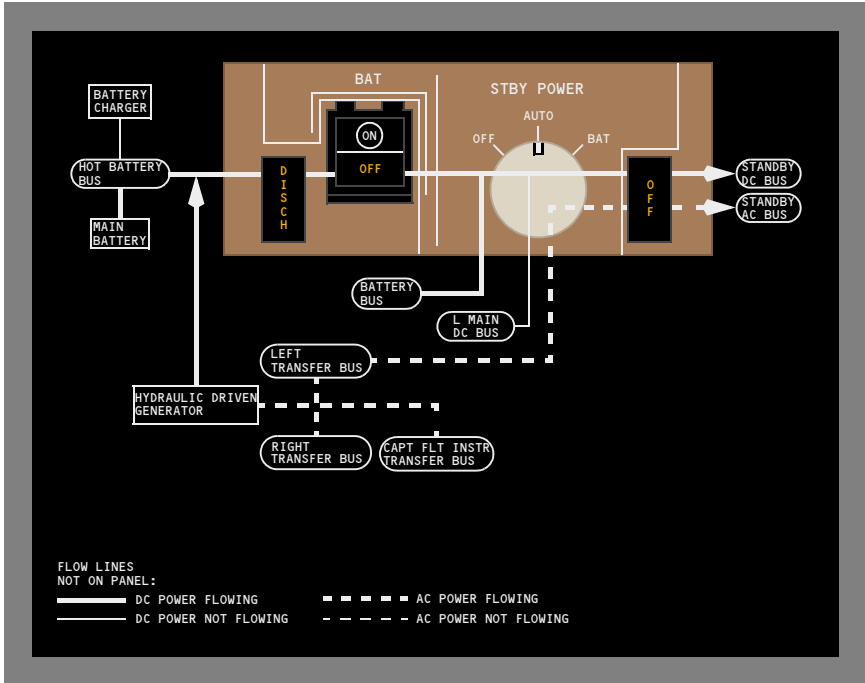

**Electrical EICAS Messages**

The following EICAS messages can be displayed.

Message	Level	Light	Aural	Condition
L AC BUS OFF R AC BUS OFF	Caution	BUS OFF	Beeper	AC Bus is unpowered.
APU GEN OFF	Advisory	OFF		APU generator control breaker is open due to a fault with the APU running.
BATTERY OFF	Advisory	OFF		Battery switch is OFF.
L BUS ISOLATED R BUS ISOLATED	Advisory	ISLN		Bus tie breaker is open due to an AC electrical system fault.
L GEN DRIVE R GEN DRIVE	Advisory	DRIVE		Generator drive oil pressure is low or generator drive oil temperature is high.
L GEN OFF R GEN OFF	Advisory	OFF		Generator control breaker is open.
MAIN BAT DISCH	Advisory	DISCH		Main battery is discharging.
STANDBY BUS OFF	Advisory	OFF		Standby AC or DC bus is unpowered.
L UTIL BUS OFF R UTIL BUS OFF	Advisory	OFF		Galley and utility bus are unpowered.

Intentionally  
Blank

<b>Controls and Indicators (RR)</b> .....	<b>7.10</b>
EICAS Displays .....	7.10.1
Primary Engine Indications .....	7.10.1
Secondary Engine Indications .....	7.10.8
Compact Engine Indications .....	7.10.16
Engine Controls .....	7.10.17
Thrust Levers .....	7.10.17
Fuel Control Switches .....	7.10.18
Electronic Engine Control (EEC) .....	7.10.19
Engine Limiter Control (ELC) .....	7.10.19
Engine Control Panel .....	7.10.20
Thrust Mode Select Panel (TMSP) .....	7.10.21
EICAS Control Panel .....	7.10.22
<b>Controls and Indicators (PW)</b> .....	<b>7.11</b>
EICAS Displays .....	7.11.1
Primary Engine Indications .....	7.11.1
Secondary Engine Indications .....	7.11.8
Compact Engine Indications .....	7.11.15
Engine Controls .....	7.11.16
Thrust Levers .....	7.11.16
Fuel Control Switches .....	7.11.17
Engine Control Panel .....	7.11.18
Thrust Mode Select Panel (TMSP) .....	7.11.19
EICAS Control Panel .....	7.11.20
<b>Controls and Indicators</b> .....	<b>7.15</b>
Auxiliary Power Unit (APU) .....	7.15.1
APU Controls .....	7.15.1
APU Indications .....	7.15.2
<b>Engine System Description (RR)</b> .....	<b>7.20</b>
Introduction .....	7.20.1

---

Engine Indications . . . . .	7.20.1
Primary Engine Indications . . . . .	7.20.1
Secondary Engine Indications . . . . .	7.20.1
Normal Display Format . . . . .	7.20.2
Compact Display Format . . . . .	7.20.2
Engine Secondary Data Cue . . . . .	7.20.3
Engine Pressure Ratio (EPR) . . . . .	7.20.3
Thrust Management Computer (TMC) . . . . .	7.20.4
Reduced Takeoff Thrust . . . . .	7.20.5
Assumed Temperature Takeoff . . . . .	7.20.5
Reduced Climb Thrust . . . . .	7.20.6
Electronic Engine Control (EEC) . . . . .	7.20.6
Engine Limiter Control (ELC) . . . . .	7.20.7
Overboost/Overspeed Protection . . . . .	7.20.7
Idle Selection . . . . .	7.20.7
Engine Start and Ignition System . . . . .	7.20.8
Engine Start . . . . .	7.20.8
Starter Operation . . . . .	7.20.8
In-Flight Start . . . . .	7.20.9
Engine Ignition . . . . .	7.20.9
Engine Start and Ignition System Schematic . . . . .	7.20.10
Engine Fuel System . . . . .	7.20.11
Fuel control Unit . . . . .	7.20.11
Engine and Spar Valves . . . . .	7.20.11
Fuel Filters . . . . .	7.20.11
Fuel Flow Measurement . . . . .	7.20.12
Engine Fuel System Schematic . . . . .	7.20.13
Engine Oil System . . . . .	7.20.14
Engine Oil System Schematic . . . . .	7.20.15
Thrust Reverser System . . . . .	7.20.16
Thrust Reverser Schematic . . . . .	7.20.17
Airborne Vibration Monitoring System . . . . .	7.20.18



---

<b>Engine System Description (PW)</b> .....	<b>7.21</b>
Introduction .....	7.21.1
Engine Indications .....	7.21.1
Primary Engine Indications .....	7.21.1
Secondary Engine Indications .....	7.21.1
Normal Display Format .....	7.21.2
Compact Display Format .....	7.21.2
Engine Secondary Data Cue .....	7.21.3
Engine Pressure Ratio (EPR) .....	7.21.3
Thrust Management Computer (TMC) .....	7.21.4
Reduced Takeoff Thrust .....	7.21.5
Assumed Temperature Takeoff .....	7.21.5
Reduced Climb Thrust .....	7.21.6
Electronic Engine Control (EEC) .....	7.21.6
EPR and N1 Control Modes .....	7.21.6
N2 Control Mode .....	7.21.7
Engine Stator Vanes .....	7.21.7
Overspeed Protection .....	7.21.7
Idle Selection .....	7.21.8
Engine Start and Ignition System .....	7.21.8
Engine Start .....	7.21.9
Starter Operation .....	7.21.9
In-Flight Start .....	7.21.10
Engine Ignition .....	7.21.10
Engine Start and Ignition System Schematic .....	7.21.11
Engine Fuel System .....	7.21.12
Fuel control Unit .....	7.21.12
Engine and Spar Valves .....	7.21.12
Fuel Filter .....	7.21.12
Fuel Flow Measurement .....	7.21.13
Engine Fuel System Schematic .....	7.21.13
Engine Oil System .....	7.21.14
Engine Oil System Schematic .....	7.21.15

---

Thrust Reverser System .....	7.21.16
Thrust Reverser Schematic .....	7.21.17
Airborne Vibration Monitoring System .....	7.21.18
<b>APU System Description .....</b>	<b>7.30</b>
Introduction .....	7.30.1
APU Operation .....	7.30.1
APU Start .....	7.30.1
APU Run .....	7.30.2
APU Shutdown .....	7.30.2
Protection System .....	7.30.2
<b>EICAS Messages (RR) .....</b>	<b>7.40</b>
Engines, APU EICAS Messages .....	7.40.1
<b>EICAS Messages (PW) .....</b>	<b>7.41</b>
Engines, APU EICAS Messages .....	7.41.1

**EICAS Displays**

**Primary Engine Indications**



**1 Primary Engine Indications**

Displayed full time on the EICAS display:

- EPR
- N1
- EGT

## Mode Indications

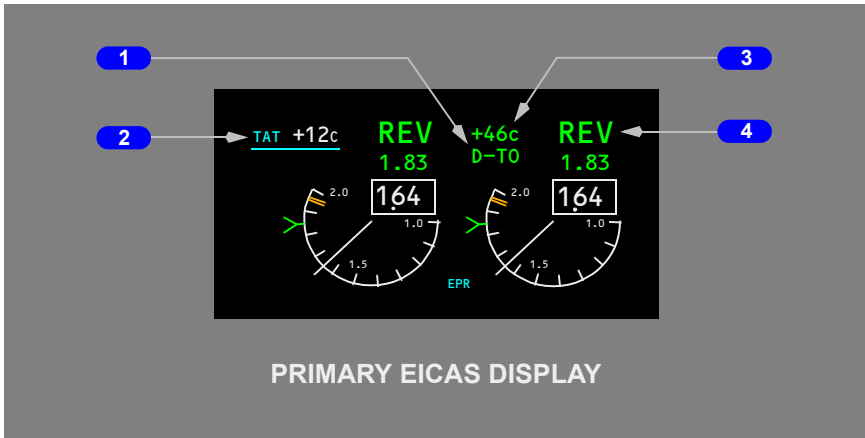

### 1 Thrust Reference Mode

Displayed (green) – selected FMS thrust reference mode:

Takeoff:

- TO – maximum rated takeoff thrust
- TO 1 – takeoff thrust one, climb one preselected
- TO 2 – takeoff thrust two, climb two preselected
- TO 1 \* – maximum rated takeoff thrust, climb one preselected
- TO 2 \* – maximum rated takeoff thrust, climb two preselected

Assumed Temperature Takeoff:

- D–TO – assumed temperature derated takeoff thrust
- D–TO 1 – assumed temperature derated takeoff thrust one, climb one preselected
- D–TO 2 – assumed temperature derated takeoff thrust two, climb two preselected
- D–TO 1 \* – assumed temperature derated takeoff thrust, climb one preselected
- D–TO 2 \* – assumed temperature derated takeoff thrust, climb two preselected

Climb:

- CLB – maximum rated climb thrust
- CLB 1 – derate one climb thrust
- CLB 2 – derate two climb thrust

Cruise:

- CRZ – maximum rated cruise thrust
- CRZ 1 \* – maximum rated cruise thrust, climb one preselected
- CRZ 2 \* – maximum rated cruise thrust, climb two preselected

Continuous:

- CON – maximum rated continuous thrust
- CON 1 \* – maximum rated continuous thrust, climb one preselected
- CON 2 \* – maximum rated continuous thrust, climb two preselected

Go-around and Manual:

- G/A – maximum go-around thrust
- MAN – reference EPR manually selected

## **2 Total Air Temperature (TAT)**

Displayed (cyan) – "TAT" and underline

Displayed (white) - temperature (degrees C)

## **3 Assumed Temperature**

Displayed (green) – selected assumed temperature (degrees C) for reduced thrust takeoff

## **4 Thrust Reverser Indication**

Displayed REV (amber) – reverser in transit

Displayed REV (green) – reverser fully deployed

### **EPR Indications**

**Note:** When reverse thrust is activated, the following indications are not displayed:

- reference/target EPR indication
- thrust reference mode
- reference EPR

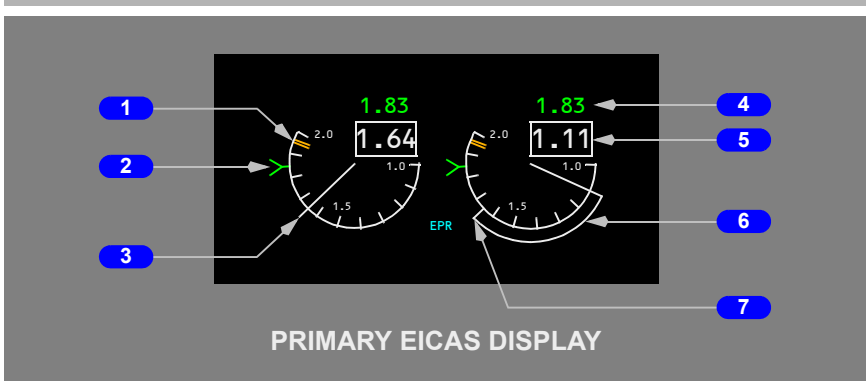

**1 Maximum EPR Line**

Displayed (amber)

**2 Reference/Target EPR indication**

Displayed (green) – reference EPR limit

Displayed (magenta) – target FMC commanded EPR when VNAV is engaged

**3 EPR Pointer**

Displayed (white)

**4 Reference EPR**

Displayed (green)

**5 Actual EPR**

Displayed (white)

**6 Commanded EPR Sector**

Displays momentary difference between engine EPR and EPR commanded by thrust lever position

**7 Command Thrust Level**

Displayed (white):

- end of command sector
- appears as extension of EPR pointer when engine stabilized
- EPR commanded by thrust lever position
- inhibited when EEC off or inoperative

## N1 Indications

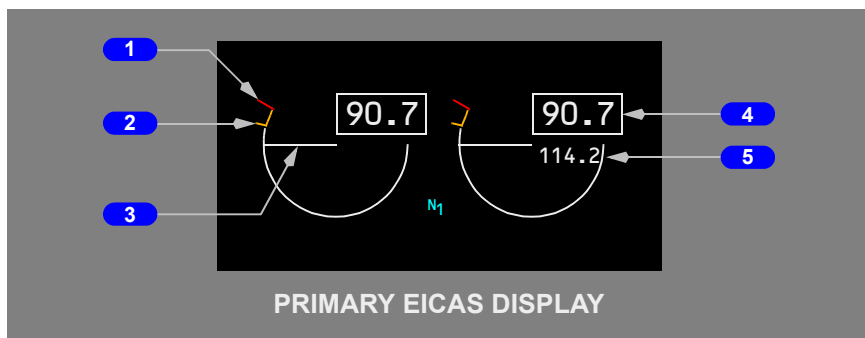

### 1 N1 Red Line Limit

Displayed (red) – N1 RPM operating limit

### 2 N1 Amber Band

Displayed (amber) – caution range for N1 RPM

### 3 N1 Pointer

- (white) – points at value equal to that shown in the N1 counter
- (amber) – N1 RPM in amber band\*
- (red) – operating limit reached or exceeded

### 4 N1

N1 RPM (%), displayed:

- (white) – normal operating range
- (amber) – N1 RPM in amber band\*
- (red) – operating limit reached or exceeded

### 5 Maximum Exceedance

Displayed (white):

- red line limit or transient limit is exceeded
- highest value attained

**Note:** \* Pointer and counter remain white during TO or GA for 5 minutes after amber band is entered.

## EGT Indications

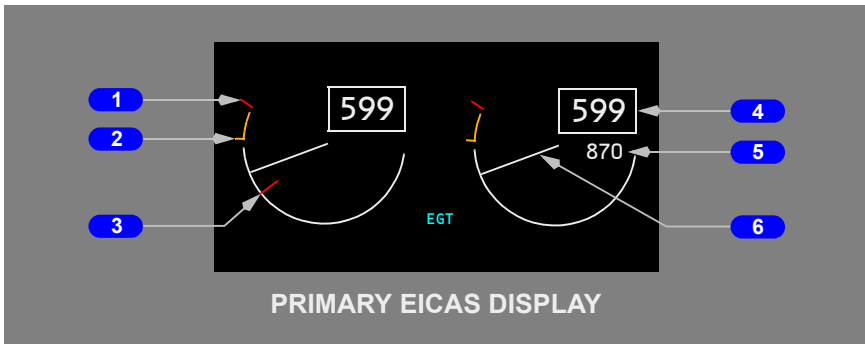

### 1 EGT Red Line

Displayed (red) – maximum takeoff EGT limit

### 2 EGT Amber Band

Displayed (amber) – maximum continuous EGT limit

### 3 EGT Start Limit Line

Displayed (red) – during start until engine is stabilized at minimum idle RPM

### 4 EGT

EGT (degrees C), displayed:

- (white) – normal operating range
- (amber) – maximum continuous limit reached\*
- (red) – maximum start or takeoff limit reached

### 5 EGT Maximum Exceedance

Displayed (white):

- red line limit, transient limit or start EGT is exceeded
- displays the highest value attained

### 6 EGT Pointer

Displayed:

- (white) – normal operating range
- (amber) – maximum continuous limit reached\*
- (red) – maximum start or takeoff limit reached

**Note:** \* Pointer and counter remain white during TO or GA for 5 minutes after amber band is entered.



## Anti-Ice Indications

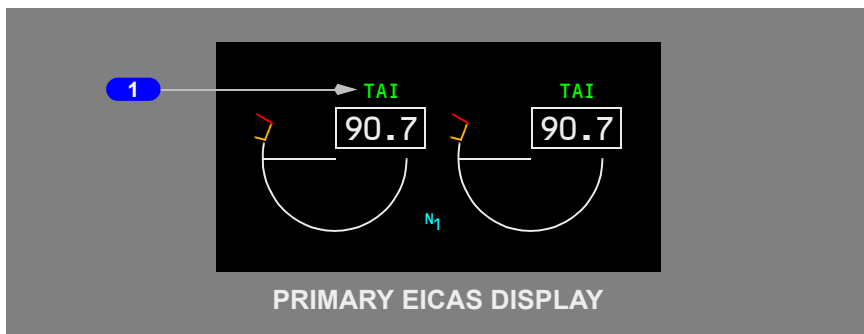

### 1 Thermal Anti-Ice (TAI) Indication

Displayed (green) – engine anti-ice is on

## In-Flight Start Envelope

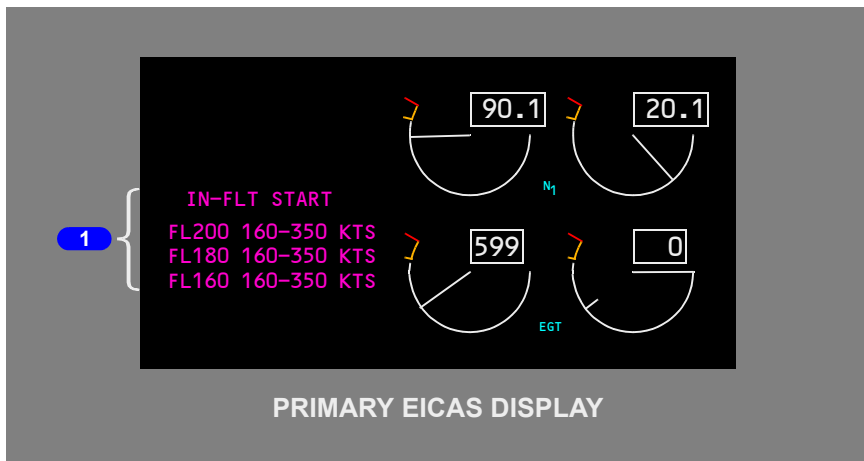

### 1 In-Flight Start Envelope

Displayed (magenta) – airspeed range for an inflight start for the closest starting flight level and two descending flight levels at two thousand foot intervals when the respective engine fire switch is in and:

- a FUEL CONTROL switch is in CUT OFF, and
- engine N3 RPM is below idle, and
- primary and secondary EICAS displayed

## Secondary Engine Indications

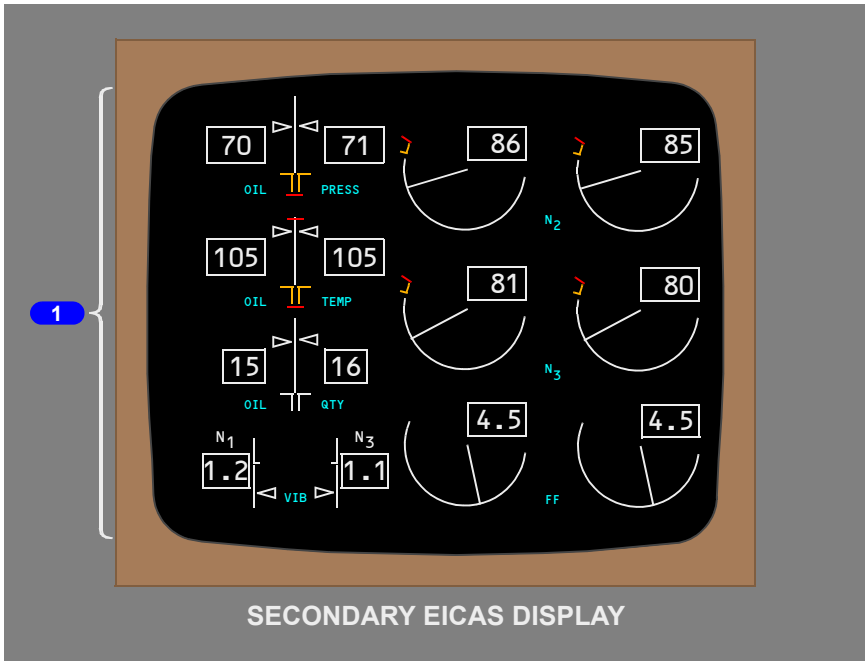

### 1 Secondary Engine Display

Displays:

- N<sub>2</sub> RPM
- N<sub>3</sub> RPM
- fuel flow (FF)
- oil pressure
- oil temperature
- oil quantity
- vibration

## N2 Indications

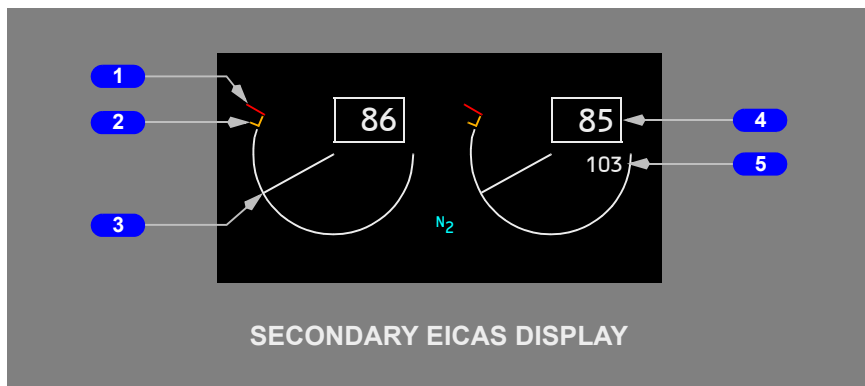

### 1 N2 Red Line

N2 RPM operating limit, displayed (red)

### 2 N2 Amber Band

Caution range for N2 RPM, displayed (amber)

### 3 N2 Pointer

N2 RPM, displayed:

- (white) – normal operating range
- (amber) – N2 RPM in amber band\*
- (red) – operating limit reached or exceeded

### 4 N2

N2 RPM (%), displayed:

- (white) – normal operating range
- (amber) – N2 RPM in amber band\*
- (red) – operating limit reached

**Note:** \* N2 Indication and N2 remain white during TO or GA for 5 minutes after N2 amber band is entered.

### 5 Maximum Exceedance

Displayed (white):

- red line limit is exceeded
- highest value attained

## N3 Indications

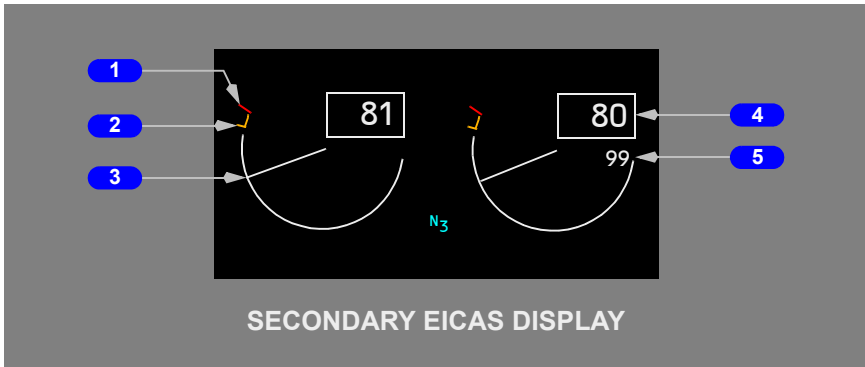

### 1 N3 Red Line

N3 RPM operating limit, displayed (red)

### 2 N3 Amber Band

Caution range for N3 RPM, displayed (amber)

### 3 N3 Pointer

N3 RPM, displayed:

- (white) – normal operating range
- (amber) – N3 RPM in amber Band\*
- (red) – operating limit reached or exceeded

### 4 N3

N3 RPM (%), displayed:

- (white) – normal operating range
- (amber) – N3 RPM in amber band\*
- (red) – operating limit reached

**Note:** \* N3 Indication and N3 remain white during TO or GA for 5 minutes after N3 amber band is entered.

### 5 Maximum Exceedance

Displayed (white):

- red line limit is exceeded
- highest value attained

## Crossbleed Start Indications

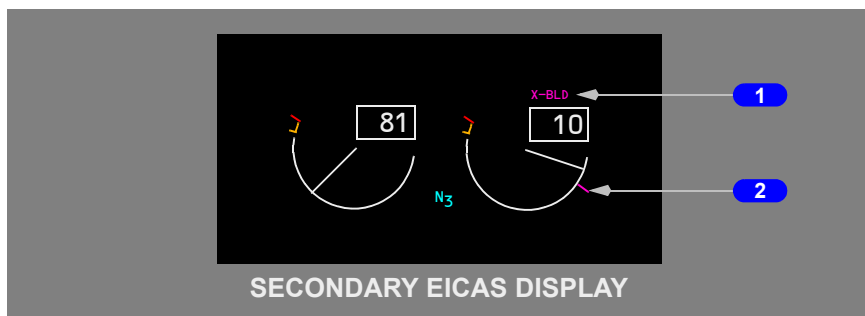

### 1 Crossbleed Start (X-BLD) Indication

Indicates crossbled air is recommended for an inflight start

Displayed (magenta):

- the inflight start envelope is displayed, and
- airspeed is lower than that for a windmilling start

### 2 Fuel On Command Bug

Displayed (magenta):

- engine is shutdown on the ground or inflight when X-BLD is displayed
- minimum fuel on selection point during starter cranking

## Fuel Flow Indications

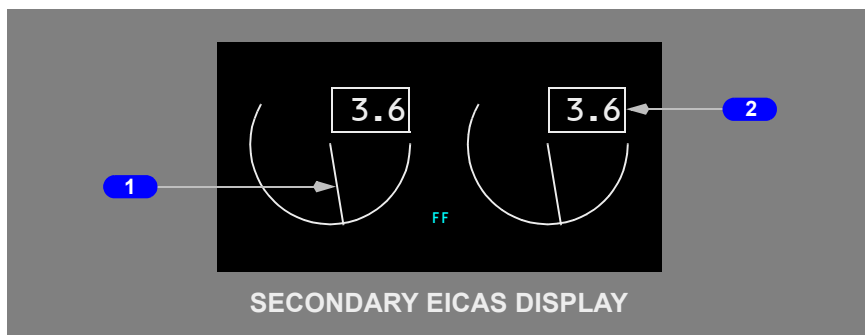

### 1 Fuel Flow Pointer

Displayed (white) – points at a value equal to that shown in the Fuel Flow

### 2 Fuel Flow (FF)

Displayed (white) – fuel flow to the engine (pounds per hour x 1000)

## Oil Pressure Indications

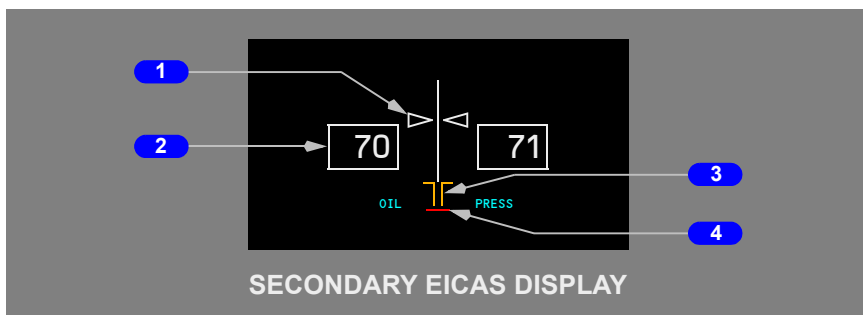

### 1 Oil Pressure Pointer

Engine oil pressure, displayed:

- (white) – normal operating range
- (amber) – caution range reached
- (red) – operating limit reached

### 2 Oil Pressure (OIL PRESS)

Engine oil pressure (psi), displayed:

- (white) – normal operating range
- (amber) – caution range reached
- (red) – operating limit reached

### 3 Oil Pressure Amber Band

Displayed (amber) – caution range for low oil pressure

### 4 Oil Pressure Red Line

Displayed (red) – low oil pressure operating limit

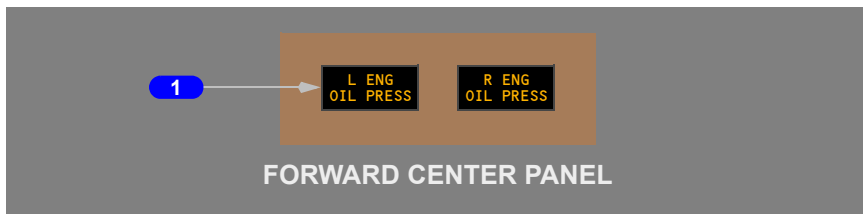

### 1 Engine Oil Pressure (L or R ENG OIL PRESS) Lights

Illuminated (amber):

- respective engine oil pressure is at or below minimum
- oil pressure switch malfunction

## Oil Temperature Indications

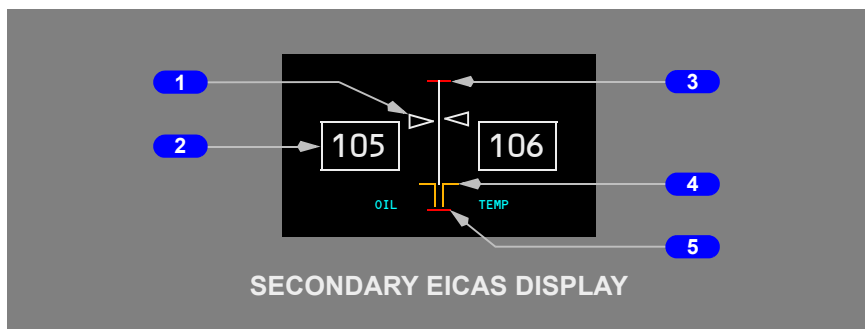

### 1 Oil Temperature Pointer

Engine oil temperature, displayed:

- (white) – normal operating range
- (amber) – caution range reached
- (red) – operating limit reached

### 2 Oil Temperature

Engine oil temperature (degrees C), displayed:

- (white) – normal operating range
- (amber) – caution range reached
- (red) – operating limit reached

### 3 Upper Oil Temperature Red Line

Displayed (red) – oil temperature operating limit

### 4 Oil Temperature Amber Band

Displayed (amber) – oil temperature caution range

### 5 Lower Oil Temperature Red Line

Displayed (red) – oil temperature operating limit

## Oil Quantity Indications

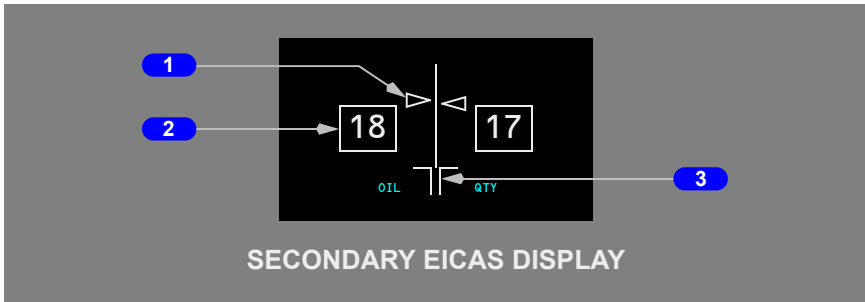

### 1 Oil Quantity Pointer

Displayed (white) – points at a value equal to that shown in the Oil Quantity

### 2 Oil Quantity

Usable oil quantity (quarts), displayed:

- (white) – normal quantity

### 3 Low Oil Quantity Band

Displayed (white) – awareness range for low oil quantity

## Engine Vibration Indications

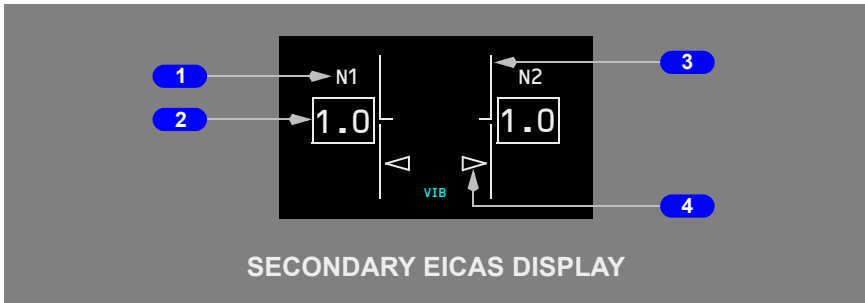

### 1 Vibration Source

Identifies the vibration source being displayed

Displayed (white) – vibration source with the highest vibration:

- N1 rotor vibration
- N2 rotor vibration
- N3 rotor vibration



If the vibration source BB (broad band vibration) is displayed, the source is unknown and average vibration is displayed

## 2 Engine Vibration

Engine vibration, displayed:

- (white) – normal operating range
- (amber) – vibration in amber band

## 3 Engine Vibration Amber Band

Caution range for high vibration

## 4 Engine Vibration Pointer

Displayed (white) – engine vibration:

**Standby Engine Indicator (SEI)**

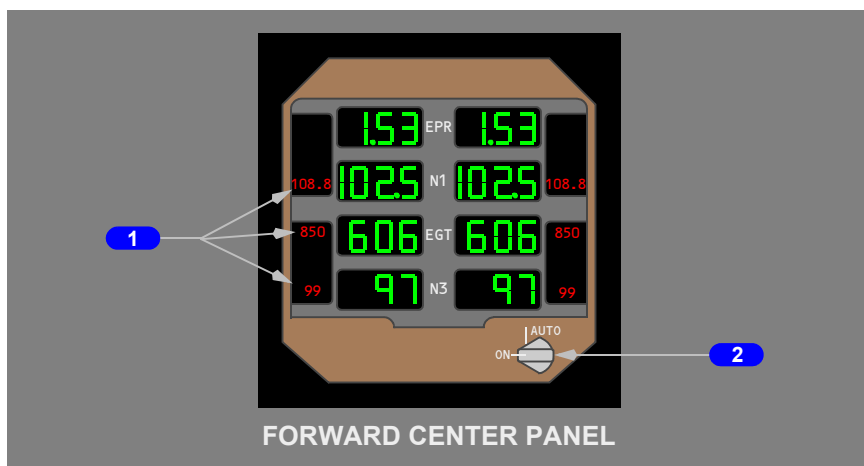

## 1 Maximum Engine Limits

## 2 Standby Engine Indicator Selector

AUTO –

- display is blank with AC power on the airplane and EICAS operative
- standby engine indications in view when:
  - AC power is lost (EPR not displayed)
  - either CRT failed and STATUS selected on the ground
  - EICAS failed

ON – standby engine indications in view

## Compact Engine Indications



### 1 Compact Engine Indications

The following changes to EICAS and the normal secondary engine display occur:

- EGT, N2 and N3 change from round dial displays to digital displays. The EGT display/box, N2 and N3 displays turn amber or red if the limit is exceeded.
- FF, OIL PRESS and OIL TEMP are displayed as digital readouts only. The OIL PRESS and OIL TEMP digital displays turn amber or red if limits are exceeded.
- OIL QTY and VIB are displayed as digital readouts only. Low oil quantity and high vibrations are displayed the same as in the normal format.

## Engine Controls

### Thrust Levers

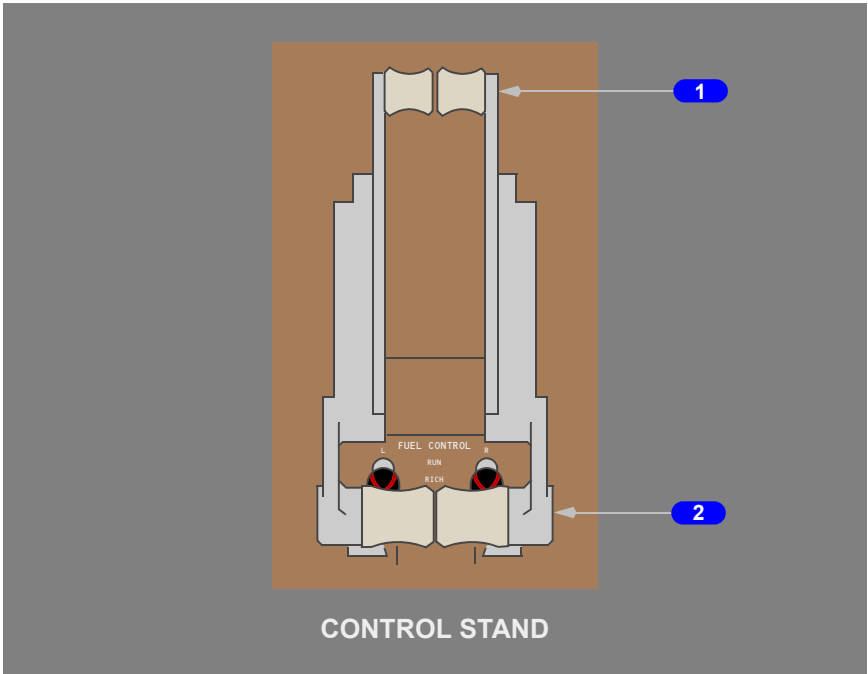

#### 1 Reverse Thrust Levers

Control engine reverse thrust

Reverse thrust can only be selected when the forward thrust levers are closed  
Actuates automatic speedbrakes (refer to Chapter 9, Flight Controls)

#### 2 Forward Thrust Levers

Controls engine forward thrust

The thrust levers can only be advanced if the reverse thrust levers are down

## Fuel Control Switches

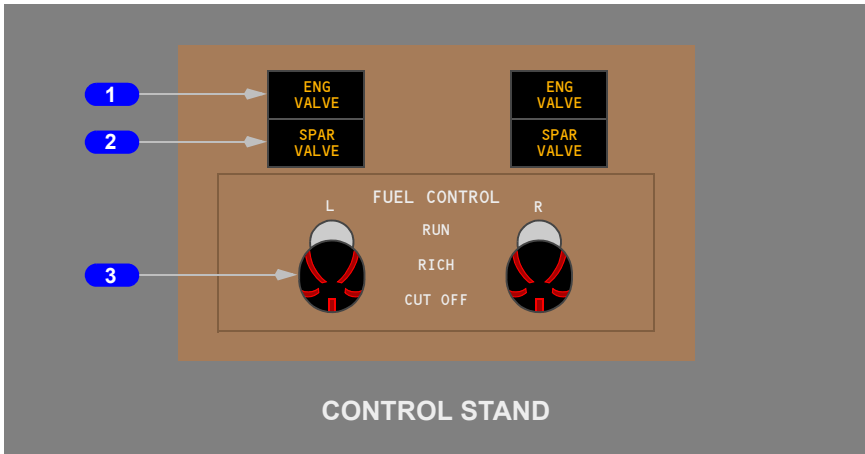

### 1 Engine Valve (ENG VALVE) Lights

Illuminated (amber) – engine fuel valve is not in commanded position

### 2 SPAR VALVE Lights

Illuminated (amber) – fuel spar valve is not in commanded position

### 3 FUEL CONTROL Switches

RUN –

- normal position for flight
- opens engine and spar fuel valves
- activates selected ignitor(s)

RICH –

- initially schedules additional fuel for start
- opens the engine and spar fuel valve
- activates selected ignitor(s)

CUT OFF –

- closes engine and spar fuel valves
- terminates ignition

## Electronic Engine Control (EEC)

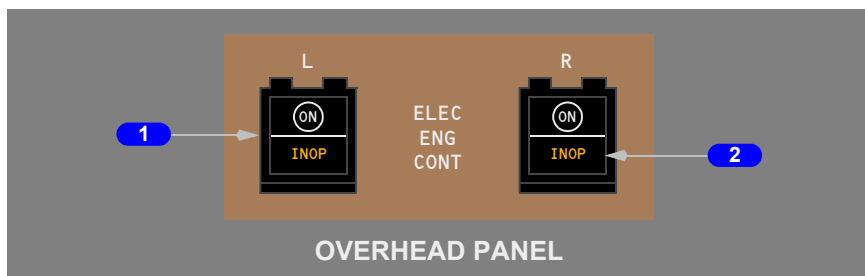

### 1 Electronic Engine Control (ELEC ENG CONT) Switches

ON – electronic fuel control trims fuel flow for EPR limiting

Off (ON not visible) – hydromechanical fuel control scheduling fuel flow

### 2 EEC Inoperative (INOP) Lights

Illuminated (amber):

- EEC inoperative
- EEC selected OFF

## Engine Limiter Control (ELC)

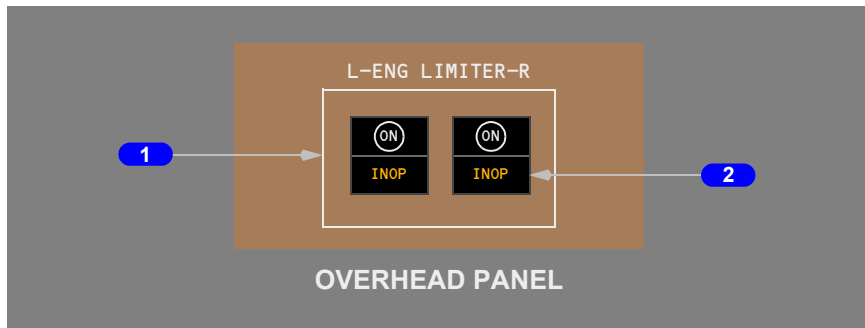

### 1 Engine Limiter Control (ENG LIMITER) Switches

ON – engine limiter control trims fuel flow for N1 limiting

Off (ON not visible) – engine limiter control inoperative

### 2 Engine Limiter Inoperative (INOP) Lights

Illuminated (amber):

- ELC inoperative
- ELC selected OFF

## Engine Control Panel

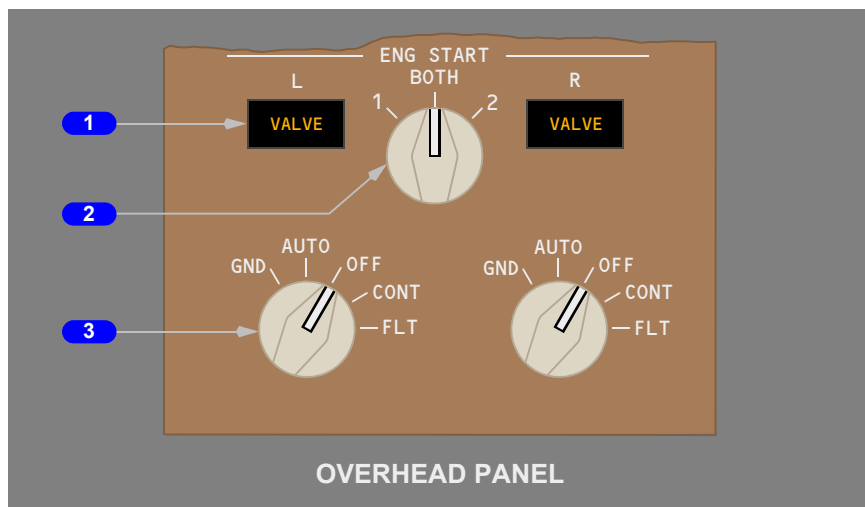

### 1 Engine Start VALVE Lights

Illuminated (amber):

- valve is not in commanded position
- N3 RPM exceeds 47% and starter valve open

### 2 Ignition Selector

BOTH – both ignitors in each engine operate when directed by Engine Start Selector

1 or 2 – selected ignitor in each engine operate when directed by Engine Start Selector

### 3 Engine Start Selector

GND (push-in and rotate) –

- opens start valve to supply starter air
- arms selected ignitor(s)
- selector magnetically held in GND position until 47% N3 RPM

AUTO –

- selector releases to AUTO at 47% N3 RPM
- closes start valve and terminates ignition
- selected ignitor(s) operate continuously with slats extended or engine anti-ice on

OFF – no ignition

CONT –

- selected ignitor(s) operate continuously
- no time limit

FLT –

- both ignitors operate continuously regardless of ignition selector position
- no time limit

## Thrust Mode Select Panel (TMSP)

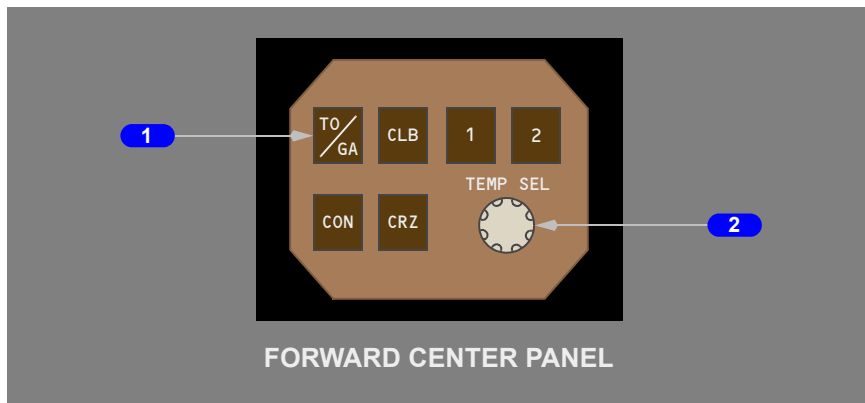

### **1** Thrust Reference Mode Select Switches

PUSH –

- manually selects desired thrust reference mode
- selected thrust reference mode and reference EPR are displayed

TO/GA –

- selects TO mode on the ground or GA mode inflight
- cancels preselected climb one or two
- cancels selected assumed temperature
- selecting 1 or 2 with TO or D-TO reference mode displayed:
  - preselects CLB 1 or CLB 2 on the ground if autothrottles not engaged
  - subsequent push cancels any preselected 1 or 2
  - cancels selected assumed temperature
  - selects TO 1 or TO 2

CLB –

- selects CLB
- selects CLB 1 or CLB 2 if 1 or 2 is preselected
- selecting 1 or 2 with CLB Reference mode displayed:
  - selects CLB 1 or CLB 2
- with CLB 1 or CLB 2 reference mode displayed:

- subsequent push of active mode switch cancels 1 or 2
- with CLB 2 reference mode displayed:
  - switch 1 selects CLB 1

CON –

- selects CON mode
- selecting 1 or 2 with CON reference mode displayed:
  - preselects CLB 1 or CLB 2

CRZ –

- selects CRZ mode
- selecting 1 or 2 with CRZ reference mode displayed:
  - preselects CLB 1 or CLB 2

**Note:** With VNAV engaged, manual selection of GA, CLB, CON and CRZ is inhibited.

## 2 Assumed Temperature Selector (TEMP SEL)

Functions only with TO, TO 1 or TO 2 mode displayed

Sets assumed temperature

ROTATE CLOCKWISE –

- assumed temperature appears on EICAS
- one click equals 1 degree centigrade

## EICAS Control Panel

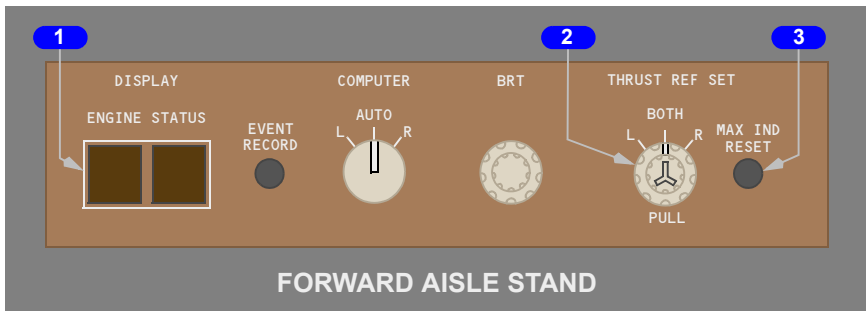

## 1 ENGINE Display Switch

Push – displays the secondary engine parameters on the lower EICAS CRT

If secondary engine parameters are already displayed and no limits have been exceeded, the display blanks



## **2 Manual Thrust Reference Set (THRUST REF SET) Controls**

Outer Knob:

- BOTH – both EPR bugs may be set to the same value
- L or R – only the selected EPR bug may be set to the desired value. Bugs may be set at different values

Inner Knob:

- PUSH – reference EPR is set automatically
- PULL – reference EPR is set manually. MAN appears in EPR thrust reference mode display and EPR bug moves to 1.55.
- Rotate – in manual mode, sets EPR bug and reference EPR to desired value

## **3 Maximum Indication Reset (MAX IND RESET) Switch**

Push – resets and blanks all maximum exceedance values on EGT, N1, N2 and N3

Intentionally  
Blank

## EICAS Displays

### Primary Engine Indications

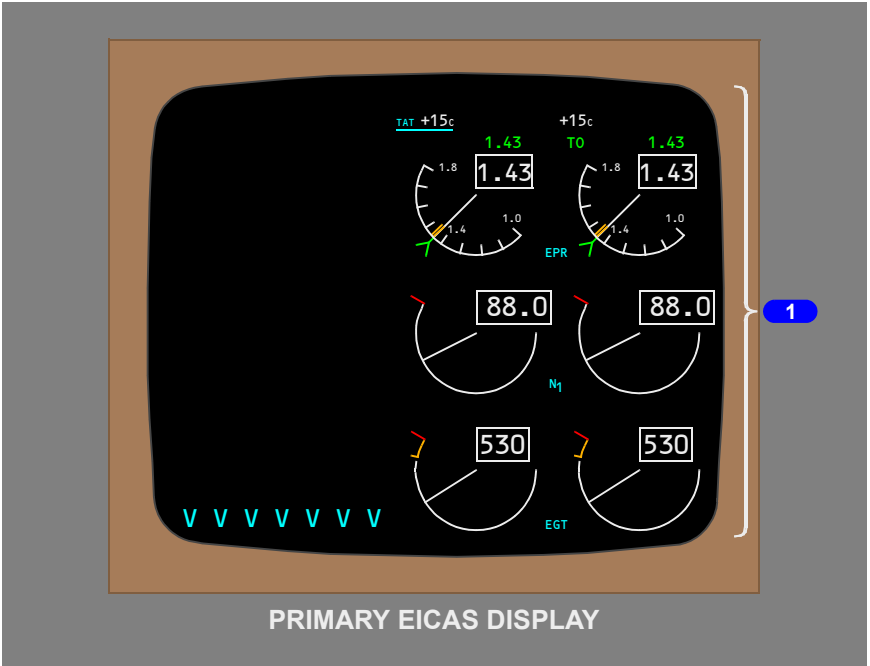

#### 1 Primary Engine Indications

Displayed full time on the EICAS display:

- EPR
- N1
- EGT

## Mode Indications

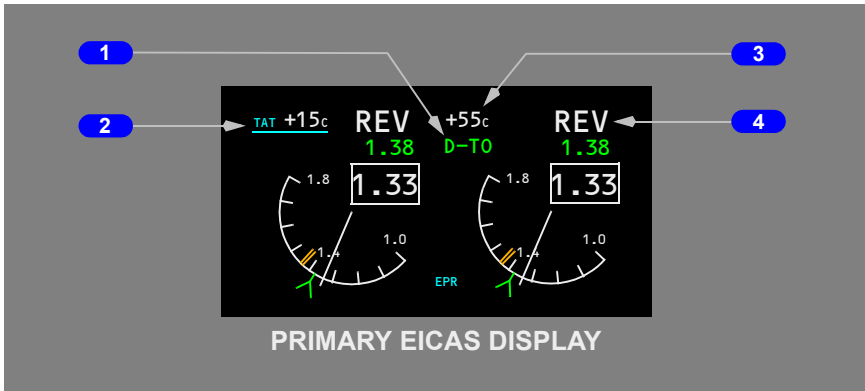

### 1 Thrust Reference Mode

Displayed (green) – selected FMS thrust reference mode:

Takeoff:

- TO – maximum rated takeoff thrust
- TO 1 – takeoff thrust one, climb one preselected
- TO 2 – takeoff thrust two, climb two preselected
- TO 1 \* – maximum rated takeoff thrust, climb one preselected
- TO 2 \* – maximum rated takeoff thrust, climb two preselected

Assumed Temperature Takeoff:

- D–TO – assumed temperature derated takeoff thrust
- D–TO 1 – assumed temperature derated takeoff thrust one, climb one preselected
- D–TO 2 – assumed temperature derated takeoff thrust two, climb two preselected
- D–TO 1 \* – assumed temperature derated takeoff thrust, climb one preselected
- D–TO 2 \* – assumed temperature derated takeoff thrust, climb two preselected

Climb:

- CLB – maximum rated climb thrust
- CLB 1 – derate one climb thrust
- CLB 2 – derate two climb thrust

Cruise:

- CRZ – maximum rated cruise thrust
- CRZ 1 \* – maximum rated cruise thrust, climb one preselected
- CRZ 2 \* – maximum rated cruise thrust, climb two preselected

Continuous:

- CON – maximum rated continuous thrust
- CON 1 \* – maximum rated continuous thrust, climb one preselected
- CON 2 \* – maximum rated continuous thrust, climb two preselected

Go-around and Manual:

- G/A – maximum go-around thrust
- MAN – reference EPR manually selected

## 2 Total Air Temperature (TAT)

Displayed (cyan) – "TAT" and underline

Displayed (white) - temperature (degrees C)

## 3 Assumed Temperature

Displayed (green) – selected assumed temperature (degrees C) for reduced thrust takeoff

## 4 Thrust Reverser Indication

Displayed REV (amber) – reverser in transit

Displayed REV (green) – reverser fully deployed

## EPR Indications

**Note:** When reverse thrust is activated, the following indications are not displayed:

- reference/target EPR indication
- thrust reference mode
- reference EPR

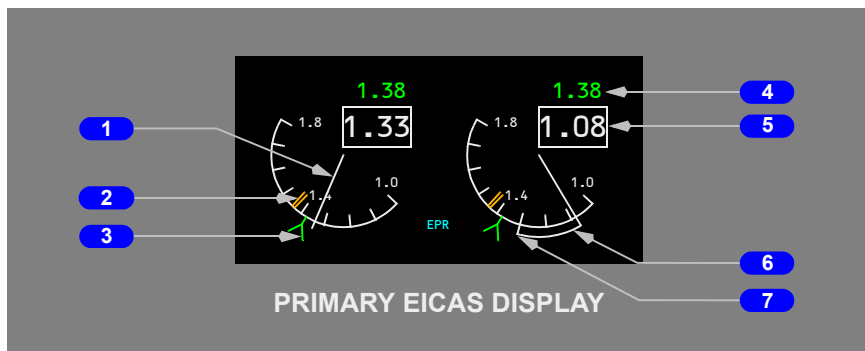

**1 EPR Pointer**

Displayed (white)

**2 Maximum EPR Line**

Displayed (amber)

**3 Reference/Target EPR indication**

Displayed (green) – reference EPR limit

Displayed (magenta) – target FMC commanded EPR when VNAV is engaged

**4 Reference EPR**

Displayed (green)

**5 Actual EPR**

Displayed (white)

**6 Commanded EPR Sector**

Displays momentary difference between engine EPR and EPR commanded by thrust lever position

**7 Command Thrust Level**

Displayed (white):

- end of command sector
- appears as extension of EPR pointer when engine stabilized
- EPR commanded by thrust lever position

**N1 Indications**

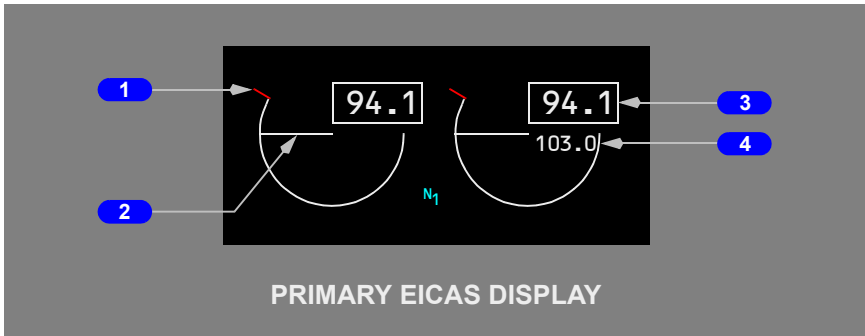

**1 N1 Red Line Limit**

Displayed (red) – N1 RPM operating limit

**2 N1 Pointer**

- (white) – points at value equal to that shown in the N1 counter
- (red) – operating limit reached or exceeded

**3 N1**

N1 RPM (%), displayed:

- (white) – normal operating range
- (red) – operating limit reached or exceeded

**4 Maximum Exceedance**

Displayed (white):

- red line limit or transient limit is exceeded
- highest value attained

**EGT Indications**

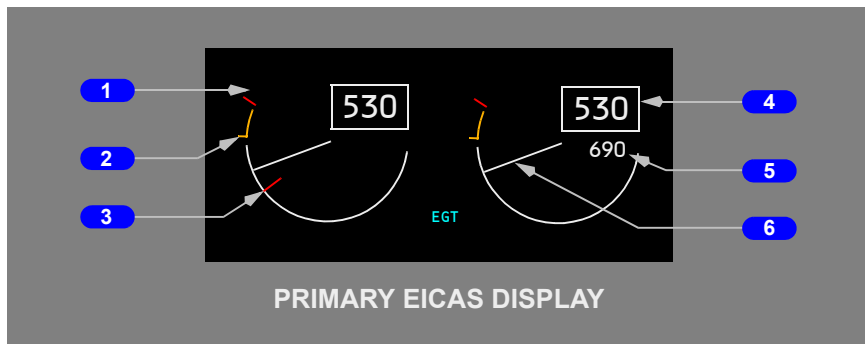

**1 EGT Red Line**

Displayed (red) – maximum takeoff EGT limit

**2 EGT Amber Band**

Displayed (amber) – maximum continuous EGT limit

**3 EGT Start Limit Line**

Displayed (red) – during start until engine is stabilized at minimum idle RPM

**4 EGT**

EGT (degrees C), displayed:

- (white) – normal operating range
- (amber) – maximum continuous limit reached\*
- (red) – maximum start or takeoff limit reached

**Note:** \* Pointer and counter remain white during TO or GA for 5 minutes after amber band is entered.

**5 EGT Maximum Exceedance**

Displayed (white):

- red line limit, transient limit or start EGT is exceeded
- displays the highest value attained

**6 EGT Pointer**

Displayed:

- (white) – normal operating range
- (amber) – maximum continuous limit reached
- (red) – maximum start or takeoff limit reached

**Anti-Ice Indications**

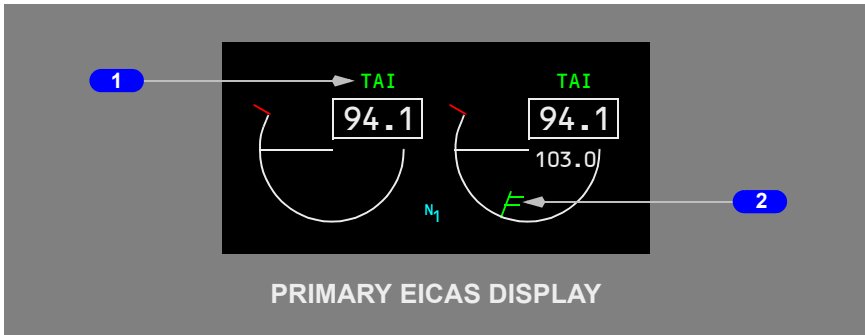

**1 Thermal Anti-Ice (TAI) Indication**

Displayed (green) – engine anti-ice is on

**2 TAI Bug**

Displayed when engine anti-ice is ON and only a single engine bleed source is available. Appears on N1 indicator of engine supplying bleed air. Displays minimum N1 RPM required for engine anti-ice operation.

- (green) – N1 RPM is at or above minimum
- (amber) – N1 RPM is below minimum



## In-Flight Start Envelope

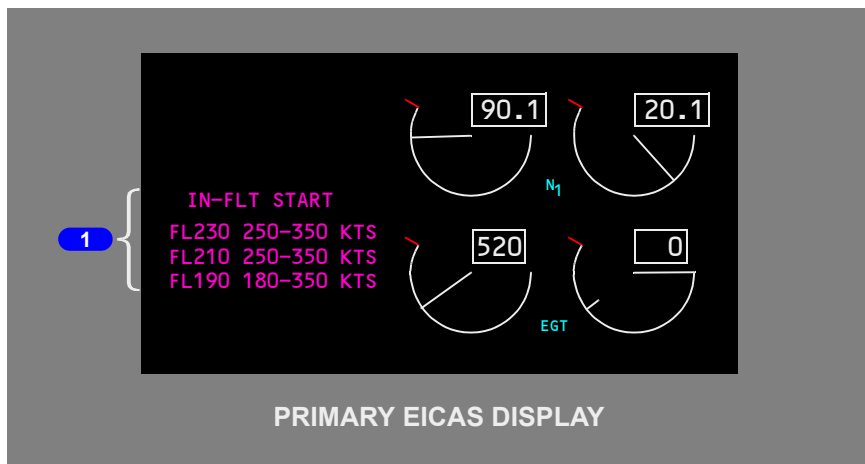

### **1** In-Flight Start Envelope

Displayed (magenta) – airspeed range for an inflight start for the closest starting flight level and two descending flight levels at two thousand foot intervals when the respective engine fire switch is in and:

- a FUEL CONTROL switch is in CUT OFF, and
- engine N2 RPM is below idle, and
- primary and secondary EICAS displayed

## Secondary Engine Indications

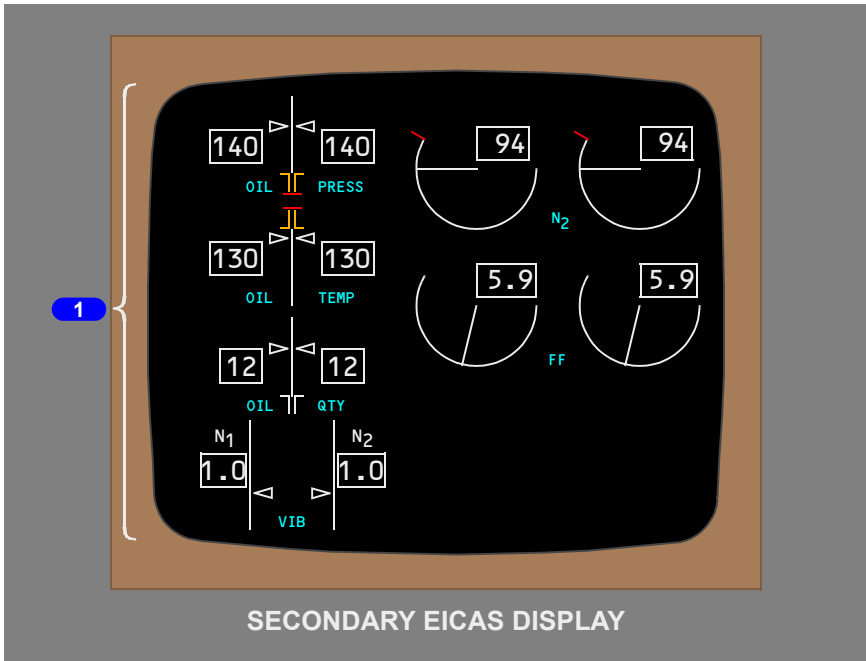

### 1 Secondary Engine Display

Displays:

- N2 RPM
- fuel flow (FF)
- oil pressure
- oil temperature
- oil quantity
- vibration

## N2 Indications

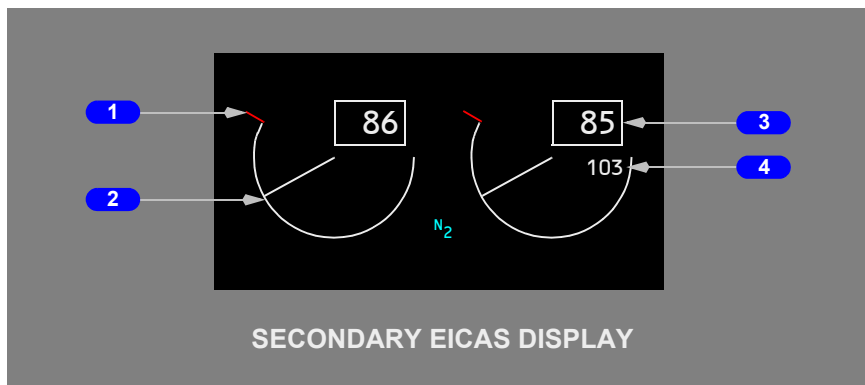

### 1 N2 Red Line

N2 RPM operating limit, displayed (red)

### 2 N2 Pointer

N2 RPM, displayed:

- (white) – normal operating range
- (red) – operating limit reached or exceeded

### 3 N2

N2 RPM (%), displayed:

- (white) – normal operating range
- (red) – operating limit reached

### 4 Maximum Exceedance

Displayed (white):

- red line limit is exceeded
- highest value attained

## Crossbleed Start Indications

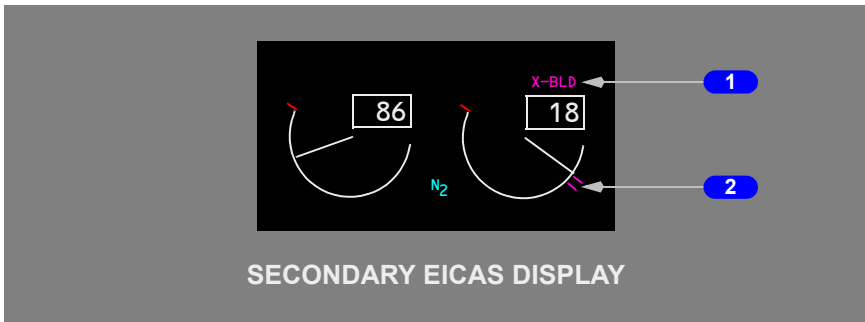

### 1 Crossbleed Start (X-BLD) Indication

Indicates crossbleed air is recommended for an inflight start

Displayed (magenta):

- the inflight start envelope is displayed, and
- airspeed is lower than that for a windmilling start

### 2 Fuel On Command Bug

Displayed (magenta):

- engine is shutdown on the ground or inflight when X-BLD is displayed
- minimum fuel on selection point during starter cranking

## Fuel Flow Indications

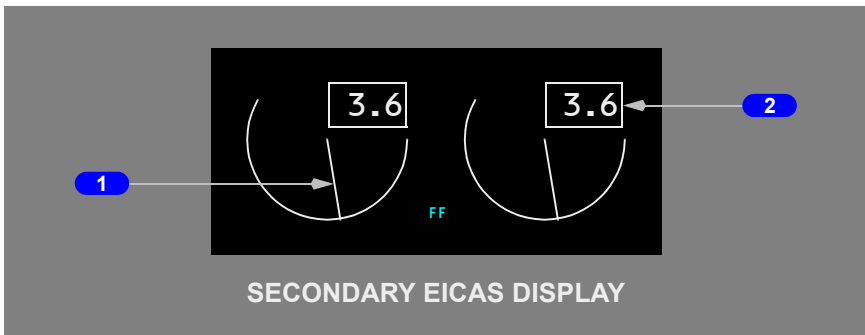

### 1 Fuel Flow Pointer

Displayed (white) – points at a value equal to that shown in the Fuel Flow

### 2 Fuel Flow (FF)

Displayed (white) – fuel flow to the engine (pounds per hour x 1000)

## Oil Pressure Indications

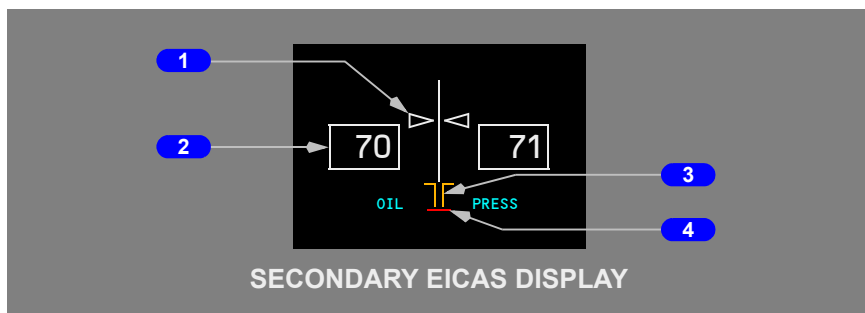

### 1 Oil Pressure Pointer

Engine oil pressure, displayed:

- (white) – normal operating range
- (amber) – caution range reached
- (red) – operating limit reached

### 2 Oil Pressure (OIL PRESS)

Engine oil pressure (psi), displayed:

- (white) – normal operating range
- (amber) – caution range reached
- (red) – operating limit reached

### 3 Oil Pressure Amber Band

Displayed (amber) – caution range for low oil pressure

### 4 Oil Pressure Red Line

Displayed (red) – low oil pressure operating limit

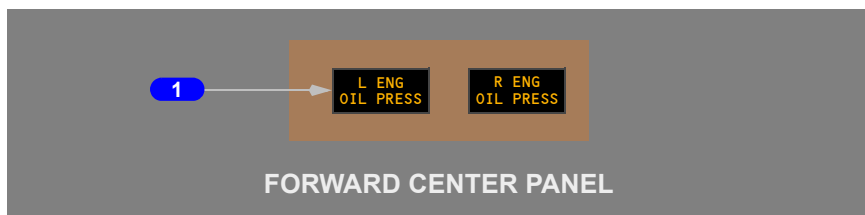

### 1 Engine Oil Pressure (L or R ENG OIL PRESS) Lights

Illuminated (amber):

- respective engine oil pressure is at or below minimum
- oil pressure switch malfunction

## Oil Temperature Indications

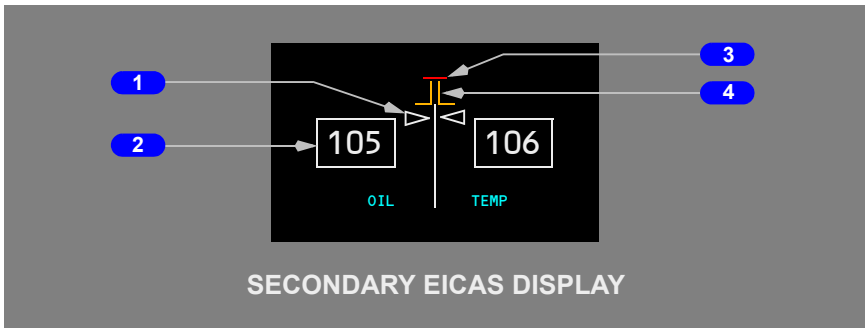

### 1 Oil Temperature Pointer

Engine oil temperature, displayed:

- (white) – normal operating range
- (amber) – caution range reached
- (red) – operating limit reached

### 2 Oil Temperature

Engine oil temperature (degrees C), displayed:

- (white) – normal operating range
- (amber) – caution range reached
- (red) – operating limit reached

### 3 Upper Oil Temperature Red Line

Displayed (red) – oil temperature operating limit

### 4 Oil Temperature Amber Band

Displayed (amber) – oil temperature caution range

## Oil Quantity Indications

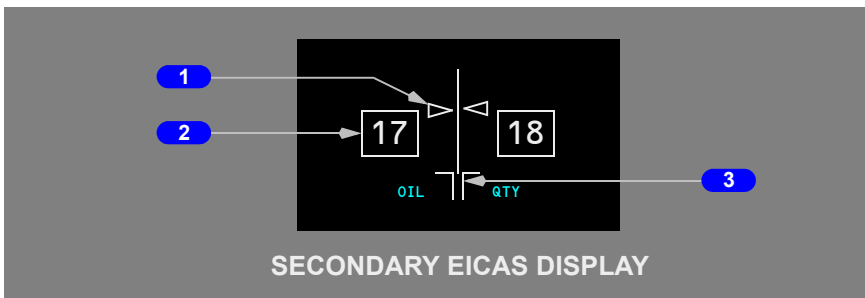

**1 Oil Quantity Pointer**

Displayed (white) – points at a value equal to that shown in the Oil Quantity

**2 Oil Quantity**

Usable oil quantity (quarts), displayed:

- (white) – normal quantity

**3 Low Oil Quantity Band**

Displayed (white) – awareness range for low oil quantity

**Engine Vibration Indications**

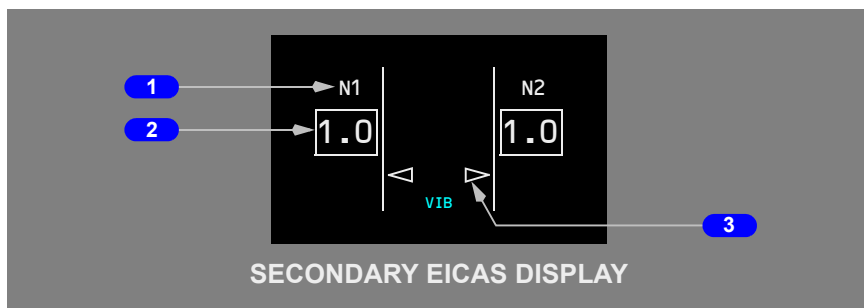

**1 Vibration Source**

Identifies the vibration source being displayed

Displayed (white) – vibration source with the highest vibration:

- N1 rotor vibration
- N2 rotor vibration

If the vibration source BB (broad band vibration) is displayed, the source is unknown and average vibration is displayed.

**2 Engine Vibration**

Displayed (white) – normal operating range

**3 Engine Vibration Pointer**

Displayed (white) – engine vibration

## Standby Engine Indicator (SEI)

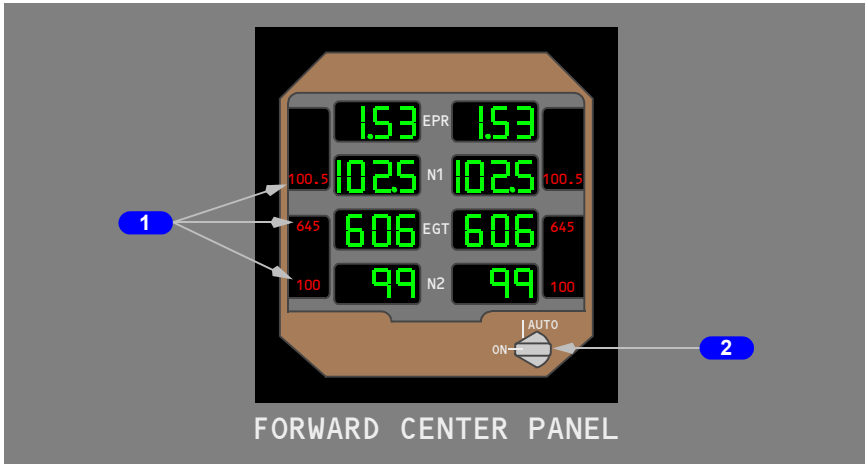

### 1 Maximum Engine Limits

### 2 Standby Engine Indicator Selector

AUTO –

- display is blank with AC power on the airplane and EICAS operative
- standby engine indications in view when:
  - AC power is lost (EPR not displayed)
  - either CRT failed and STATUS selected on the ground
  - EICAS failed

ON – standby engine indications in view



## Compact Engine Indications

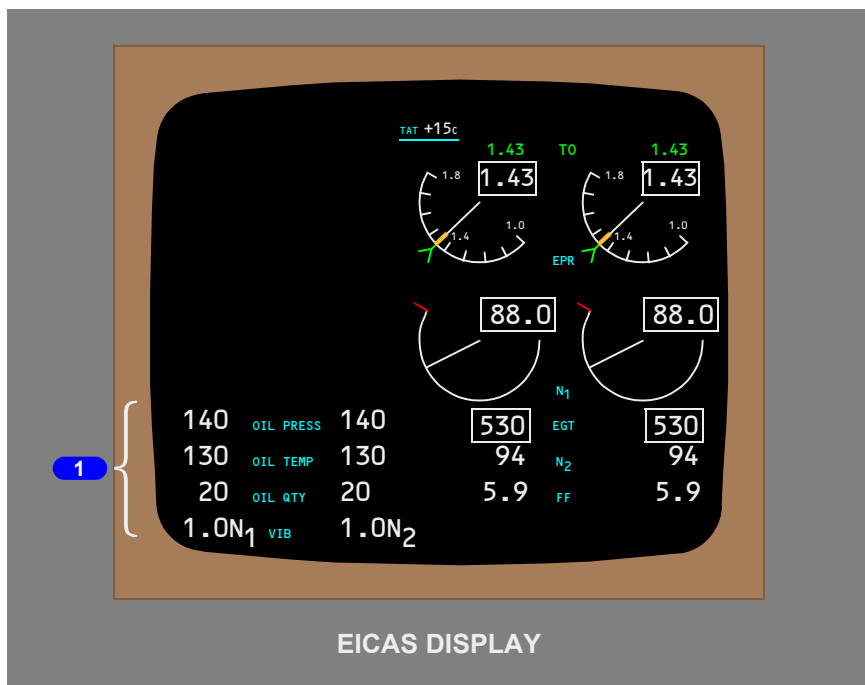

### 1 Compact Engine Indications

The following changes to EICAS and the normal secondary engine display occur:

- EGT and N2 change from round dial displays to digital displays. The EGT digital display and box turn amber or red if the limit is exceeded. The N2 digital display turns red if the limit is exceeded.
- FF, OIL PRESS and OIL TEMP are displayed as digital readouts only. The OIL PRESS and OIL TEMP digital displays turn amber or red if limits are exceeded.
- OIL QTY and VIB are displayed as digital readouts only. Low oil quantity and high vibrations are displayed the same as in the normal format.

## Engine Controls

### Thrust Levers

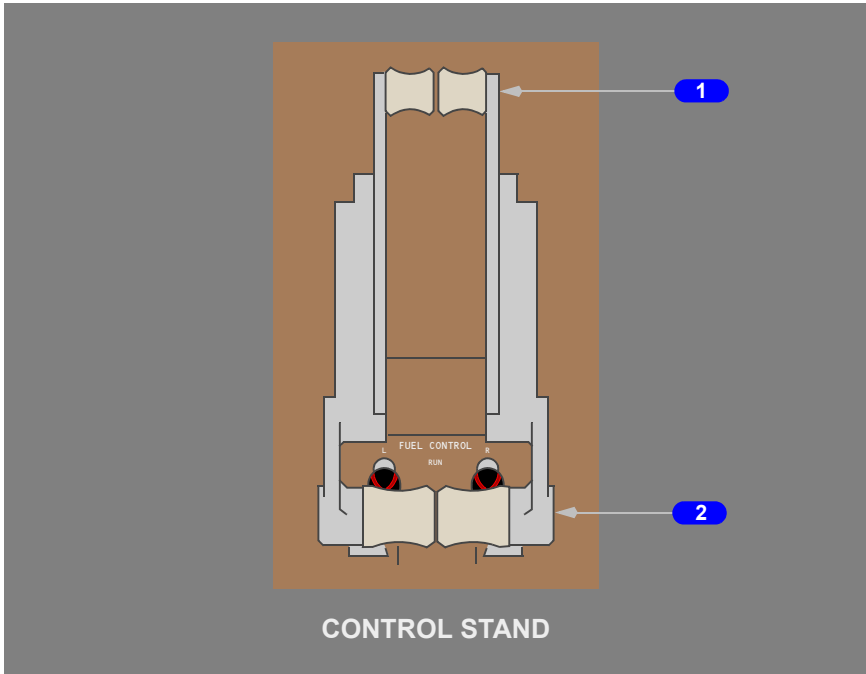

#### 1 Reverse Thrust Levers

Control engine reverse thrust

Reverse thrust can only be selected when the forward thrust levers are closed  
Actuates automatic speedbrakes (refer to Chapter 9, Flight Controls)

#### 2 Forward Thrust Levers

Controls engine forward thrust

The thrust levers can only be advanced if the reverse thrust levers are down

## Fuel Control Switches

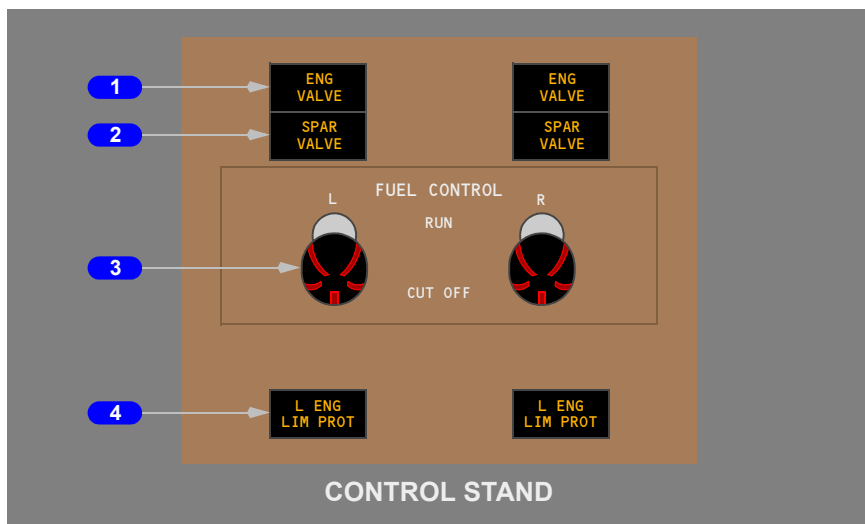

### **1** Engine Valve (ENG VALVE) Lights

Illuminated (amber) – engine fuel valve is not in commanded position

### **2** SPAR VALVE Lights

Illuminated (amber) – fuel spar valve is not in commanded position

### **3** FUEL CONTROL Switches

RUN –

- normal position for flight
- opens engine and spar fuel valves
- activates selected ignitor(s)

CUT OFF –

- closes engine and spar fuel valves
- terminates ignition

### **4** Engine Limit Protection (L or R ENG LIM PROT) Lights

Illuminated (amber):

- N2 is controlling fuel flow parameters
- automatic engine limit protection not available for any thrust mode

## Engine Control Panel

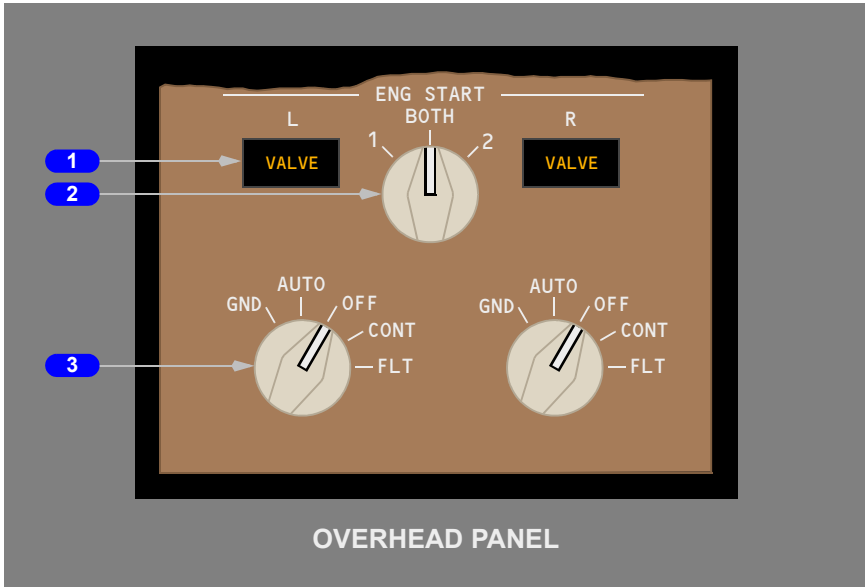

### 1 Engine Start Valve (VALVE) Lights

Illuminated (amber):

- valve is not in commanded position
- N2 RPM exceeds 50% and starter valve open

### 2 Ignition Selector

BOTH – both igniters in each engine operate when directed by Engine Start Selector

1 or 2 – selected igniter in each engine operate when directed by Engine Start Selector

### 3 Engine Start Selector

GND (push-in and rotate)

- opens start valve to supply starter air
- arms selected igniter(s)
- selector magnetically held in GND position until 50% N2 RPM

AUTO –

- selector releases to AUTO at 50% N2 RPM
- closes start valve and terminates ignition
- selected igniter(s) operate continuously with slats extended or engine anti-ice on

OFF – no ignition

CONT –

- selected igniter(s) operate continuously
- no time limit

FLT –

- both igniters operate continuously regardless of ignition selector position
- no time limit

## Thrust Mode Select Panel (TMSP)

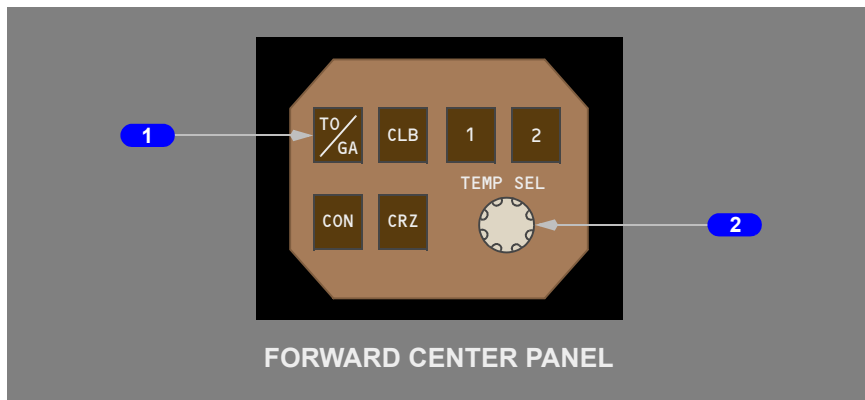

### 1 Thrust Reference Mode Select Switches

PUSH –

- manually selects desired thrust reference mode
- selected thrust reference mode and reference EPR are displayed

TO/GA –

- selects TO mode on the ground or GA mode inflight
- cancels preselected climb one or two
- cancels selected assumed temperature
- selecting 1 or 2 with TO or D-TO reference mode displayed:
  - selects TO 1 or TO 2
  - preselects CLB 1 or CLB 2 on the ground if autothrottles not engaged
  - subsequent push cancels any preselected 1 or 2
  - cancels selected assumed temperature

CLB –

- selects CLB
- selects CLB 1 or CLB 2 if 1 or 2 is preselected
- selecting 1 or 2 with CLB reference mode displayed:
  - selects CLB 1 or CLB 2
- with CLB 1 or CLB 2 reference mode displayed:
  - subsequent push of active mode switch cancels 1 or 2
- with CLB 2 reference mode displayed:
  - switch 1 selects CLB 1

CON –

- selects CON mode
- selecting 1 or 2 with CON reference mode displayed:
  - preselects CLB 1 or CLB 2

CRZ –

- selects CRZ mode
- selecting 1 or 2 with CRZ reference mode displayed:
  - preselects CLB 1 or CLB 2

**2 Assumed Temperature Selector (TEMP SEL)**

Functions only with TO, TO 1 or TO 2 mode displayed

Sets assumed temperature

ROTATE CLOCKWISE –

- assumed temperature appears on EICAS
- one click equals 1 degree centigrade

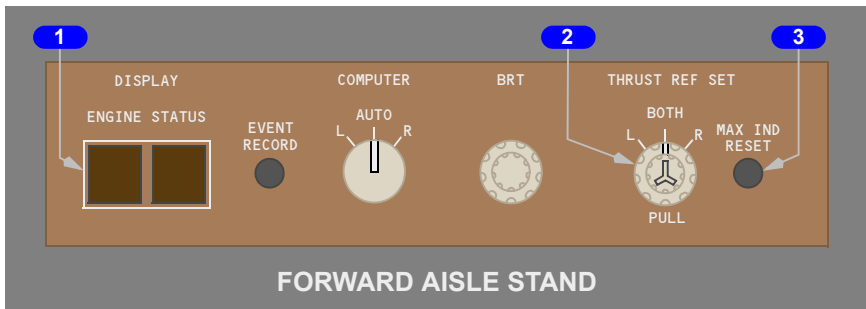
**EICAS Control Panel****1 ENGINE Display Switch**

Push – displays the secondary engine parameters on the lower EICAS CRT

If secondary engine parameters are already displayed and no limits have been exceeded, the display blanks

## **2 Manual Thrust Reference Set (THRUST REF SET) Controls**

Outer Knob:

- BOTH – both EPR bugs may be set to the same value
- L or R – only the selected EPR bug may be set to the desired value. Bugs may be set at different values.

Inner Knob:

- PUSH – reference EPR is set automatically
- PULL – reference EPR is set manually. MAN appears in EPR thrust reference mode display and EPR bug moves to 1.55.
- Rotate – in manual mode, sets EPR bug and reference EPR to desired value

## **3 Maximum Indication Reset (MAX IND RESET) Switch**

Push – resets and blanks all maximum exceedance values on EGT, N1 and N2

Intentionally  
Blank

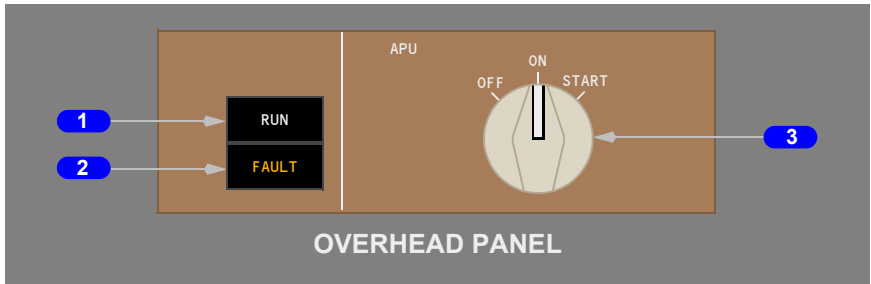

**Auxiliary Power Unit (APU)****APU Controls****1 APU RUN Light**

Illuminated (white) - APU is at operating speed

**2 APU FAULT Light**

Illuminated (amber):

- the APU has automatically shut down
- the APU fuel valve disagrees with the commanded position

**3 APU Selector**

OFF –

- closes the APU bleed air isolation valve, if open
- initiates APU cooling cycle
- shuts down APU when cooling cycle complete
- resets auto shutdown fault logic

ON (APU operating position) –

- opens the APU fuel valve and inlet door
- activates AC or DC fuel pump
- powers the APU controller
- permits the APU bleed valve to open if the APU Bleed Switch is on when APU reaches operating speed

START (momentary position, spring-loaded to ON) – initiates automatic start sequence

## APU Indications

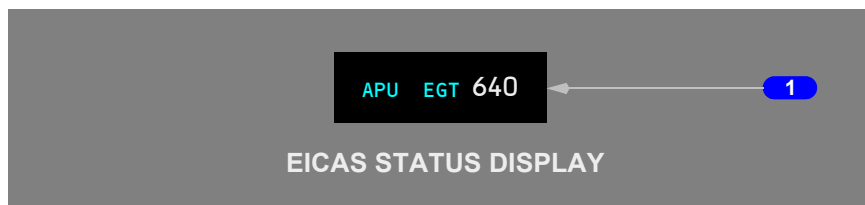

### **1** APU Status Display

EGT – APU exhaust gas temperature displayed in degrees centigrade

---

**Introduction**

The airplane is powered by two Rolls Royce RB211-535E4 engines. The engines are rated at 40,100 pounds of takeoff thrust each.

The engines are three-rotor axial flow turbofans of high compression and bypass ratio. The N1 rotor consists of the fan and a low pressure turbine section on a common shaft. The N2 rotor consists of an intermediate pressure compressor section and an intermediate pressure turbine section on a common shaft. The N3 rotor consists of a high pressure compressor section and a high pressure turbine section on common shaft. The N1, N2, and N3 rotors are mechanically independent. The N3 rotor drives the engine accessory gearbox.

Each engine has individual flight deck controls. Thrust is set by positioning the thrust levers. The thrust levers are positioned automatically by the autothrottle system or manually by the flight crew.

Each engine is controlled by an electronic engine controller (EEC). The EECs monitor autothrottle and flight crew inputs through the thrust levers to automatically control the engines.

Engine indications are displayed on the engine indication and crew alerting system (EICAS) display.

---

**Engine Indications**

Primary and secondary engine indications are provided. Engine indications are displayed on the EICAS display. In addition, annunciator lights and a liquid crystal standby engine indicator are provided to monitor engine operation.

**Primary Engine Indications**

EPR, N1, and EGT are the primary engine indications. The primary engine indications are always displayed on the upper EICAS display.

**Secondary Engine Indications**

N2, N3, fuel flow, oil pressure, oil temperature, oil quantity, and engine vibration are secondary engine indications. Secondary engine indications are displayed on the lower EICAS display. The secondary engine indications can be displayed by pushing the Engine Display Switch (the ENGINE switch on the EICAS Control Panel). The secondary engine indications are automatically displayed when:

- the displays initially receive electrical power, or
- a secondary engine parameter is exceeded

## Normal Display Format

Primary engine indications and the N2, N3 and Fuel Flow indications are digital readouts and round dial/moving pointer indications. The digital readouts display numerical values while the moving pointers indicate relative value.

Oil pressure, oil temperature, oil quantity and vibration indications are both digital readouts and vertical indication/moving pointers. All digital readouts are enclosed by boxes. The dial and vertical indications display the normal operating range, caution range, and operating limits (as applicable).

Normal operating range is displayed on a dial or vertical indication in white.

The oil temperature and oil pressure vertical indications have caution ranges displayed by amber bands. If oil temperature or oil pressure reaches the caution range, the digital readout, digital readout box, and pointer all change color to amber.

N1, EGT, N2, N3, oil pressure, and oil temperature indications have operating limits indicated by red lines. If one of these indications reaches the red line, the digital readout, box, and pointer change color to red for that indication.

The EGT indication has a maximum continuous limit represented by an amber band. If EGT reaches the maximum continuous limit, the digital indication, box, pointer, and dial all change color to amber. EGT, N1, N2 and N3 indications are inhibited from changing to amber during takeoff or go-around for five minutes.

The red line limits for these parameters are not inhibited. The EGT indication has a maximum takeoff limit displayed by a red line. If EGT reaches the maximum takeoff limit, the digital indication, box, pointer and dial, all change color to red.

The maximum EPR limit is indicated by an amber line at the top of the EPR dial. The EPR indication does not change color when maximum EPR is reached. The reference/target EPR indication displays the FMS reference or target EPR. The commanded EPR indication displays the EEC calculated EPR commanded by thrust lever position.

## Compact Display Format

In compact format, primary and secondary engine indications are combined on the same display. The EPR and N1 displays are the same as the normal displays. All other indications change to digital readouts only. If an amber or red line parameter for a digital indication is exceeded, the digital indication changes color to amber or red (as does the box that appears around an EGT indication).

Primary and secondary engine indications are displayed on EICAS in compact format whenever a CRT fails.

## Engine Secondary Data Cue

A series of blue 'v's are visible on the lower left corner of the upper EICAS CRT any time engine data is displayed on the lower EICAS CRT. If for some reason the engine data is not visible, the Status Display Switch may be used to allow the engine data to come up partially compacted on the upper EICAS CRT display.

## Engine Pressure Ratio (EPR)

Engine Pressure Ratio is the primary thrust parameter. Annunciations associated with EPR are:

- Maximum EPR
- Thrust Reference Mode
- Reference/Target EPR indication
- Reference EPR
- Assumed Temperature
- Thrust Reverser Indication
- Command Thrust Level
- Commanded EPR Sector

The maximum EPR is the maximum certified thrust limit for all phases of flight and varies with existing ambient conditions. The maximum EPR is indicated by dual amber radials on the periphery of the EPR indicator. This value is acquired from the EEC or the TMC when the EEC is OFF or INOP. With the EEC ON, the thrust levers can be moved to the forward stop and the engines will not exceed the displayed maximum EPR.

The command thrust level is a display of thrust lever position and appears as an extension of the EPR pointer when the engine is stabilized. A change in thrust lever position moves the command thrust level and displays the commanded thrust on the EPR indicator. This allows for precise thrust control.

The command EPR sector is a display of the momentary difference between the command thrust level and existing EPR and appears as a white band on the EPR indicator. As the engine accelerates or decelerates to the command thrust level the command EPR sector is erased. This allows for monitoring of engine acceleration and deceleration.

Thrust reverser indication (REV) is displayed above the EPR indicator when the reverser is activated. The annunciation is amber when the reverser is unlocked or in transit. When the reverser is fully deployed, the annunciation changes color to green and the forward thrust reference displays are inhibited.

## Thrust Management Computer (TMC)

The thrust management computer calculates a reference EPR based on existing pressure altitude and ambient temperature data from the air data system for the following modes:

- TO – takeoff
- TO 1 – takeoff one
- TO 2 – takeoff two
- D-TO – assumed temperature takeoff
- CLB – climb
- CLB 1 – climb one
- CLB 2 – climb two
- CRZ – cruise
- CON – continuous
- GA – go-around

These modes can be selected with the thrust mode select panel (TMSP). The inner thrust reference set control on the EICAS control panel must be pushed in for the thrust reference modes to be displayed on EICAS. The selected thrust reference mode is displayed above the EPR indicators. The digital reference EPR is displayed adjacent to the mode display. When the EPR bug is green, it is positioned on the EPR scale at the same value as the digital reference EPR.

The thrust mode select switches provide the capability of selecting different thrust modes for each phase of flight. The TO/GA switch is used to select takeoff thrust on the ground and go-around thrust inflight.

The 1 and 2 switches are used to select a reduced takeoff thrust rating or reduced climb thrust. When reduced takeoff thrust rating one or two is selected, this automatically preselects the associated reduced climb one or two. The CLB switch is used to select climb thrust inflight. If reduced climb thrust one or two was preselected, pushing the climb switch inflight selects CLB 1 or CLB 2.

The assumed temperature for a reduced thrust takeoff can be set by:

- using the assumed temperature selector on the TMSP
- entering the assumed temperature into the CDU TAKEOFF REF page

The CON switch is used to select maximum continuous thrust inflight. The CRZ switch is used to select cruise thrust inflight. The assumed temperature selector or the CDU is used to set assumed temperatures when reduced takeoff thrust is desired.

To manually set reference EPR values the thrust reference set control is pulled out, MAN appears as the thrust mode annunciation and the EPR bug slews to 1.55. manual reference EPR values can then be set by rotating the inner control. The outer control of the thrust reference set control is used to select the desired EPR indicator(s) for manual EPR display. The autothrottles do not respond to manually set reference EPR values. When the inner control is pulled out, the autothrottles remain in the active TMC mode. The TMSP remains operable and the autothrottles respond to TMSP mode changes, but selected thrust reference mode displays are inhibited.

When the AFDS VNAV mode is engaged, the EPR bug may be magenta. When the EPR bug is magenta, it is positioned at a nominal target EPR by the FMC, which may not correlate with the digital reference EPR. In VNAV, the FMC controls thrust mode selection automatically to meet thrust requirements for the active vertical mode of operation. The FMC does not have the capability to select reduced climb thrust values, these values must be selected manually with the 1 or 2 TMSP switches.

The thrust reference mode, reference EPR and target EPR indication are not displayed when the reversers are fully deployed.

## **Reduced Takeoff Thrust**

Two levels of reduced takeoff thrust are available with the 1 and 2 mode switches on the Thrust Mode Select Panel. These are lower thrust ratings than takeoff thrust. Takeoff 1 is approximately 88% of takeoff thrust and takeoff 2 is approximately 80% of takeoff thrust. Assumed temperature reduced thrust can be used in conjunction with these lower thrust ratings.

## **Assumed Temperature Takeoff**

The thrust management computer calculates the reference EPR for assumed temperature reduced thrust takeoff. The assumed temperature can be entered manually on the CDU TAKEOFF REF page or selected with the assumed temperature selector on the TMSP. The assumed temperature is displayed above the thrust reference mode.

When the assumed temperature selector on the TMSP is initially rotated clockwise, a reference temperature is displayed on EICAS. This temperature also appears on the CDU TAKEOFF REF page as THRUST.

Further clockwise rotation of the selector increases the assumed temperature by one degree centigrade per click. The reduced thrust annunciation of D-TO appears when the assumed temperature selected is above ambient. If the ambient temperature is greater than the initially displayed reference temperature, D-TO and reduced thrust occur when the assumed temperature selected exceeds ambient.

---

Counterclockwise rotation of the selector reduces the assumed temperature by one degree centigrade per click.

Assumed temperature takeoff thrust is limited to a 25% reduction of takeoff thrust or selected climb thrust, whichever is the greater thrust value. When the limit is reached, further adjustment to the assumed temperature by rotating the assumed temperature selector on the TMSP or changing the value entered in the CDU TAKEOFF REF page does not change the displayed assumed temperature or reference thrust value.

## Reduced Climb Thrust

Climb one or two can be preselected in conjunction with the TO, D-TO, CON and CRZ Thrust Reference modes. Reduced climb thrust is available throughout the airplanes operational envelope.

Two levels of reduced climb thrust are available with the 1 and 2 mode switches on the Thrust Mode Select Panel. Climb 1 is approximately 94% of climb thrust and climb 2 is approximately 88% of climb thrust.

---

## Electronic Engine Control (EEC)

The thrust system consists of a hydromechanical engine fuel control with an EEC unit. The EEC sets thrust by controlling EPR based on thrust lever position. EPR is commanded by positioning the thrust levers either automatically with the autothrottles, or manually by the flight crew. Both engines may be operated by conventional hydromechanical control by disengaging the EECs. Each engine EEC is powered by dual dedicated generators.

The EEC continuously computes the maximum limits for thrust. Maximum rated thrust is available in any phase of flight by moving the thrust levers to the full forward positions. Maximum EPR represents the maximum rated thrust available from the engine. These values are displayed by the position of the amber radial on the EPR display. If the EEC fails or is turned off, these values are computed by the Thrust Management Computer (TMC) and displayed in the same manner. If the TMC fails, the maximum limits are blank.

During normal EEC operation, each EEC provides a trim input to its associated hydromechanical fuel controller to drive the engine to an EEC computed Command Thrust Level. The EEC computes this EPR as a percentage of its maximum limit computation. The percentage is varied with thrust lever position, such that at full throttle, the percentage is 100%. During rapid throttle lever movements, the difference between the engines actual EPR and the EECs commanded EPR is displayed as the Command Sector on the EICAS EPR display. The engine is controlled by its hydromechanical fuel controls at low power operating conditions.



The EEC INOP light illuminates and the L or R EEC OFF EICAS caution message displays to indicate the EEC is turned off or a failure is detected in the system. When a failure is detected the EEC trim motor will hold the current trim level until the unit is turned off. When the EEC is turned off and the thrust lever is positioned full forward, a L or R EEC OFF caution message is displayed.

The thrust lever should be retarded to a mid position before turning the EEC off to prevent a possible engine overboost.

---

## **Engine Limiter Control (ELC)**

The thrust control system also includes an electronic ELC unit. If required, both engines may be operated conventionally by manually disengaging the ELCs.

Each engine ELC is powered by dual dedicated generators.

The ELC INOP light illuminates and the L or R ENG LIMITER EICAS advisory message displays to indicate the ELC is turned off or a failure is detected in the system. When a failure is detected the ELC will hold the current trim level until the unit is turned off.

When operating at or near any limit, the thrust should be reduced before turning the ELC off, otherwise a momentary overspeed condition could develop.

---

## **Overboost/Overspeed Protection**

The EEC consists of a supervisory channel and a limiter channel. The supervisory channel provides EPR overboost protection. The limiter channel provides N1 overspeed protection. If EPR or N1 approaches an overboost/overspeed condition, the EEC commands reduced fuel flow. There is no N2 overspeed protection. N3 overspeed protection is provided by the fuel control unit.

If engine limit protection is not available, advancing the thrust levers full forward should be considered only during emergency situations when all other available actions have been taken and terrain contact is imminent.

---

## **Idle Selection**

There are two engine idle speeds: minimum idle and approach idle. The fuel control unit selects these idle speeds automatically. Minimum idle is a lower thrust than approach idle and selected for ground operation and all phases of flight except approach and landing. Approach idle is selected whenever this higher idle setting is required for proper system operation.

---

---

## Engine Start and Ignition System

Air from the pneumatic duct is used to power the air driven starter, which is connected to the N3 rotor. The starter air source may be from a ground cart, APU or the other running engine.

The ENG START selectors control the start valves. Ignition and fuel flow are controlled through the FUEL CONTROL switches.

A maximum start limit line (red) is displayed on the EGT indication when the FUEL CONTROL switch is moved to CUT OFF. It remains displayed after the FUEL CONTROL switch is moved to RUN until the engine is stabilized at idle. The EGT indication changes color to red if the EGT start limit is reached during starting.

### Engine Start

Pushing in and rotating the engine start selector to the GND position, opens the start valve, engages the air driven starter to the N3 rotor and closes the engine bleed air valve if it is open. The VALVE light illuminates and the EICAS advisory message L or R ENG STARTER displays to indicate the start valve failed to open. As N3 rotation accelerates to 25% N3 or maximum motoring rpm, the fuel control switch is positioned to RUN or RICH. Maximum motoring speed is reached when acceleration is less than approximately 1% in 5 seconds. The fuel control switch opens the spar and engine fuel valves allowing the fuel to flow to the fuel control unit and activates the selected ignition. The ignition selector may be used to select BOTH, or either 1 or 2 ignitor(s). Normally, only one ignitor is used for ground start while both ignitors are used for inflight starts. At approximately 47% N3, the engine start selector automatically moves to the AUTO position. The starter automatically cuts out and the start valve closes stopping the flow of air to the starter. This allows the engine bleed valve to return to a position that agrees with the engine bleed air switch. If the start valve fails to close automatically, the corresponding valve light will illuminate and the EICAS caution message L or R STARTER CUTOUT will display. The engine start selector must be manually moved to the AUTO or OFF position to terminate starter operation.

The RUN position is normally used for start. The RICH position is used for cold engine starts.

### Starter Operation

Continuous operation of the starter must be limited in accordance with the following starter duty cycles:

### **Normal Duty Cycle**

- Up to 2 minutes continuous operation then run down to zero N3, followed by:
- Up to a further 2 minutes continuous operation then run down to zero N3, followed by:
- Up to 2 minutes continuous operation then run down to zero N3 and allow to cool for 15 minutes

### **Extended Duty Cycle**

- Up to 4 minutes continuous operation followed by 15 minutes wait

### **Re-engagement Speed**

- 0% N3 Recommended
- 0–20% N3 Normal

Re-engagement is not recommended above 20% N3 except in case of fire  
Re-engagement above 30% N3 may result in starter or gearbox damages

### **In-Flight Start**

In-flight start envelope information is displayed on the EICAS Primary Display when an engine is not running in flight, the respective engine fire switch is not pulled and both EICAS Primary and Secondary displays are selected. The inflight start envelope indicates the airspeed range necessary to ensure an inflight start at the current flight level. If the current flight level is above the maximum start altitude, the maximum start altitude and respective airspeed range are displayed.

A crossbleed start indication (X-BLD) appears above the N3 indication and a fuel on command bug is displayed if airspeed is below that recommended for a windmilling start.

### **Engine Ignition**

Each engine has two ignitors. Dual ignitors are always used for inflight starts. Main AC power is the normal power source for ignition. Standby AC power provides a backup source.

## Engine Start and Ignition System Schematic

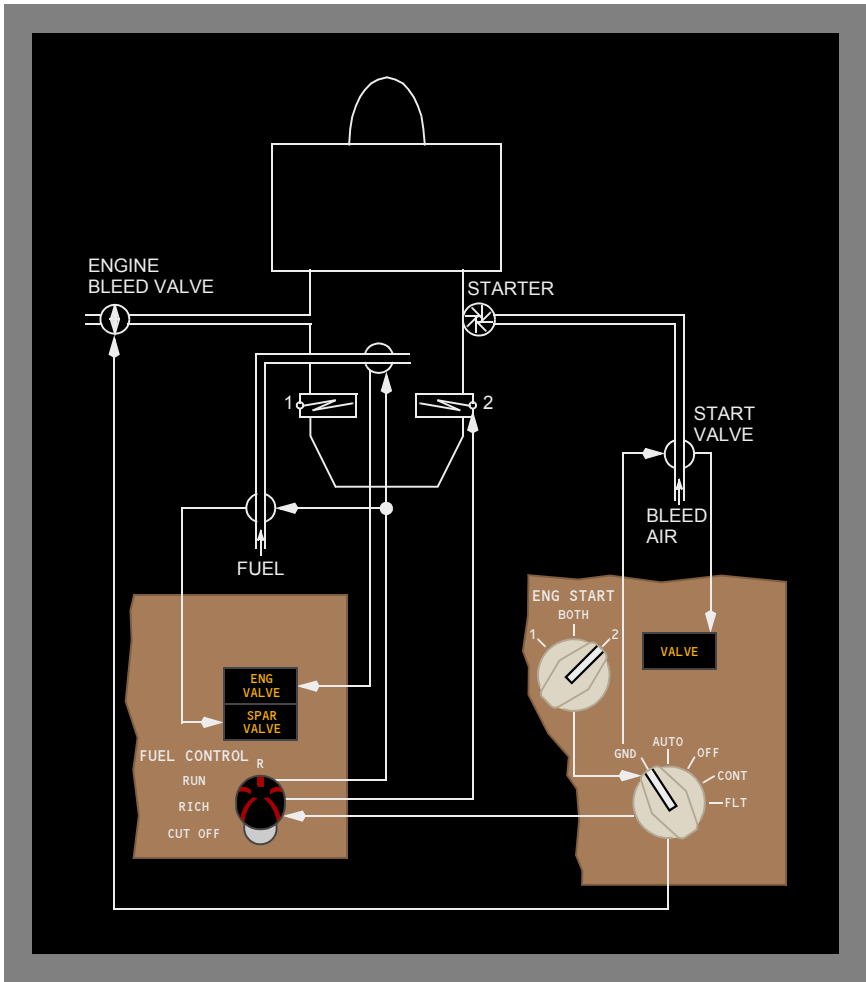

## **Engine Fuel System**

Fuel is supplied by fuel pumps located in the fuel tanks. The fuel flows through a spar fuel valve located in the main tank. It then passes through the first stage engine fuel pump where additional pressure is added. It flows through a fuel/oil heat exchanger where it is preheated. A fuel filter removes contaminants. The second stage of the engine fuel pump adds more pressure before the fuel reaches the fuel control unit. The fuel control unit adjusts fuel flow to meet thrust requirements. The fuel then flows through the engine fuel valve, fuel flow meter and a second fuel filter before entering the engine.

### **Fuel control Unit**

The engine fuel control system incorporates a hydromechanical fuel control unit which operates in conjunction with the EEC and ELC units. The fuel control system schedules fuel flow to meet engine thrust requirements as dictated by the thrust lever position and the specific engine operating conditions. The EEC trims the metered fuel to prevent overboost when operating at or near the thrust limits.

The ELC trims the metered fuel to prevent N1 from exceeding the limits.

### **Engine and Spar Valves**

The spar and engine fuel valves allow fuel flow to the engine when both valves are open. The valves open when the engine fire switch is IN and the fuel control switch is in the RICH or RUN position. Both valves close when either the fuel control switch is in CUT OFF or the engine fire switch is OUT.

The ENG VALVE and SPAR VALVE lights will illuminate momentarily as the valves open or close. If the valves do not agree with the fuel control switch or the respective fire switch position after allowing for the normal operating time, the lights remain illuminated and the EICAS advisory message L or R FUEL SPAR VAL or L or R ENG FUEL VAL displays.

### **Fuel Filters**

The fuel is filtered by two fuel filters. If the first filter becomes clogged with contaminants, fuel will bypass the filter allowing contaminated fuel to enter the fuel control unit.

The L or R ENG FUEL FILT EICAS advisory message displays to indicate the affected engine filter is clogged and is approaching a level sufficient to cause filter bypass.

Erratic engine operation and flameout may occur due to fuel contamination. The purpose of the second fuel filter is to catch debris from a deteriorating second stage fuel pump.

## **Fuel Flow Measurement**

Fuel flow is measured after passing through the engine fuel valve. Fuel flow is displayed on the secondary engine display. Fuel flow information is also provided to the FMS.

## Engine Fuel System Schematic

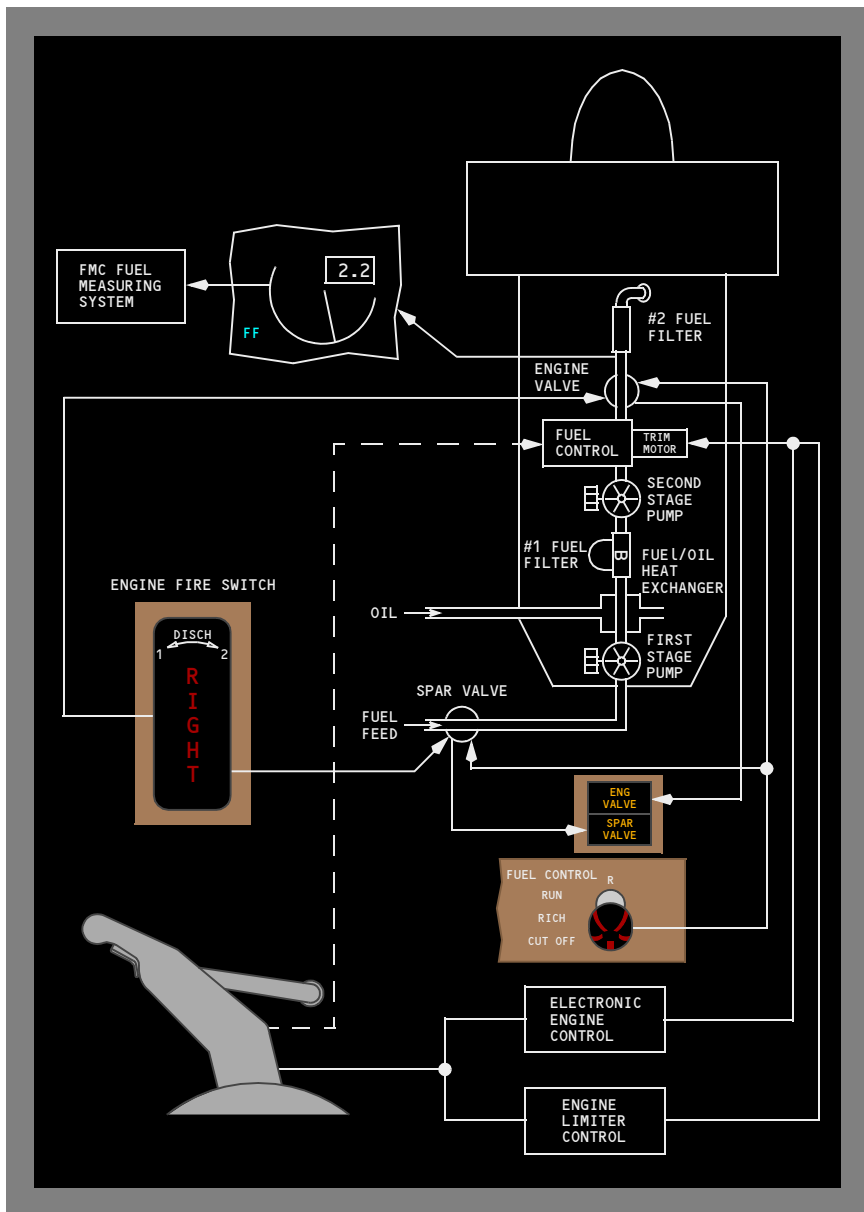

## Engine Oil System

The oil system provides pressurized oil to lubricate and cool the engine main bearings, gears and accessory drives. The oil system also provides automatic fuel heating for fuel system icing protection.

Oil is pressurized by a main (engine-driven) oil pump. From the pump, the oil flows through the main oil filter where contaminants are removed. The main oil filter cannot be bypassed. The L or R OIL FILTER EICAS advisory message displays to indicate the main oil filter is clogged. The oil flows through the oil cooler, and is then delivered to the engine main bearings, gears, and accessory drives. A scavenge pump returns the oil to the reservoir. Prior to the reservoir, the oil flows through a scavenge oil filter. If the scavenge oil filter becomes clogged, then oil bypasses the filter.

Oil pressure, temperature, and quantity are displayed on the secondary engine display.

Oil pressure is measured prior to entering the engine. When the oil pressure is at or below the variable limits, the EICAS indication changes to amber.

The L or R ENG OIL PRESS light illuminates and the L or R ENG OIL PRESS EICAS advisory message displays to indicate the oil pressure is low.

Oil temperature is measured after leaving the engine, prior to entering the reservoir.

There is no minimum oil quantity limit (no amber or red line limit). There are no operating limitations for the engine oil quantity; therefore, there are no flight crew procedures based solely on a response to low oil quantity.



## Engine Oil System Schematic

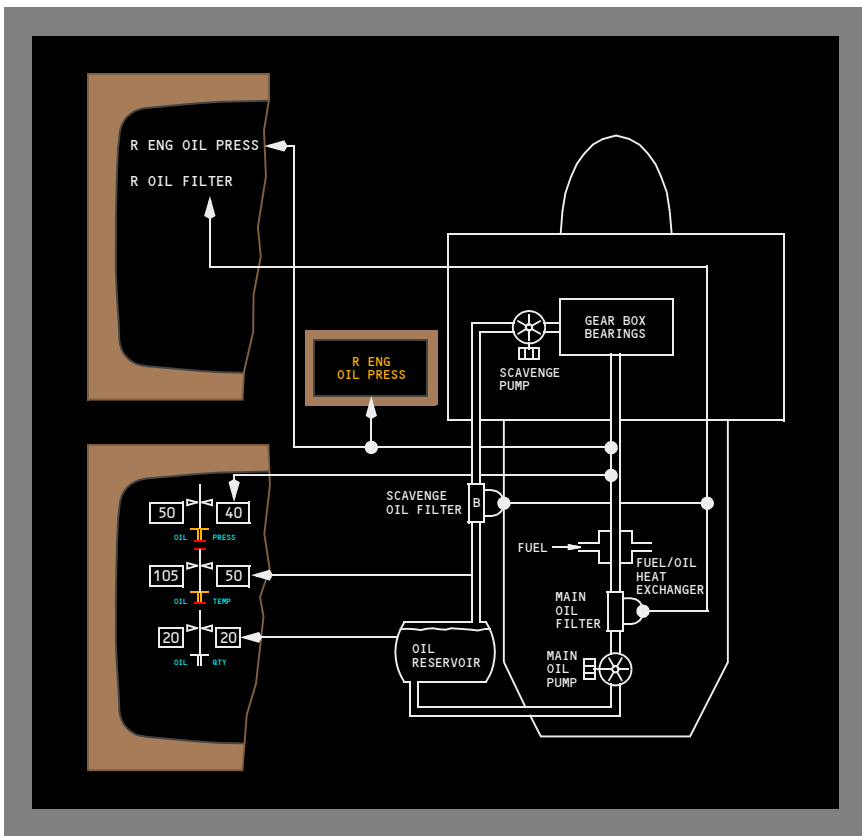

## Thrust Reverser System

Each engine has a hydraulically actuated fan air thrust reverser. Reverse thrust is available only on the ground.

The reverse thrust levers can be raised only when the forward thrust levers are in the idle position. An interlock stop limits thrust to idle reverse while the reverser is in transit.

The EECs control thrust limits during reverser operation.

When the reverse thrust levers are pulled aft to the interlock position:

- the autothrottle disengages
- the auto speedbrakes deploy

When the reverser system is activated:

- reverser isolation valve opens allowing the reverser translating sleeves to hydraulically move aft
- the fan flow blocker doors rotate into place to direct fan air through stationary cascade guide vanes
- the reverser indication (REV) is displayed above each digital EPR indication (REV is displayed in amber when the reverser is in transit)

When the interlock releases:

- the reverse thrust levers can be raised to the maximum reverse thrust position
- the REV indication changes to green when the reverser is fully deployed

Pushing the reverse thrust levers to the full down position retracts the reversers to the stowed and locked position. While the reverser is in transit, the REV annunciation changes color to amber. The thrust levers cannot be moved forward until the reverse thrust levers are fully down. When the reverser reaches the stowed position, the amber REV annunciation disappears.

On the ground, the L or R REV ISLN VAL EICAS advisory message is displayed when a fault exists in the reverser system. If this fault is detected above 80 knots during takeoff, or in flight, the message is inhibited until after landing. An electro-mechanical lock prevents uncommanded reverser deployment in the event of additional system failures.

## Thrust Reverser Schematic

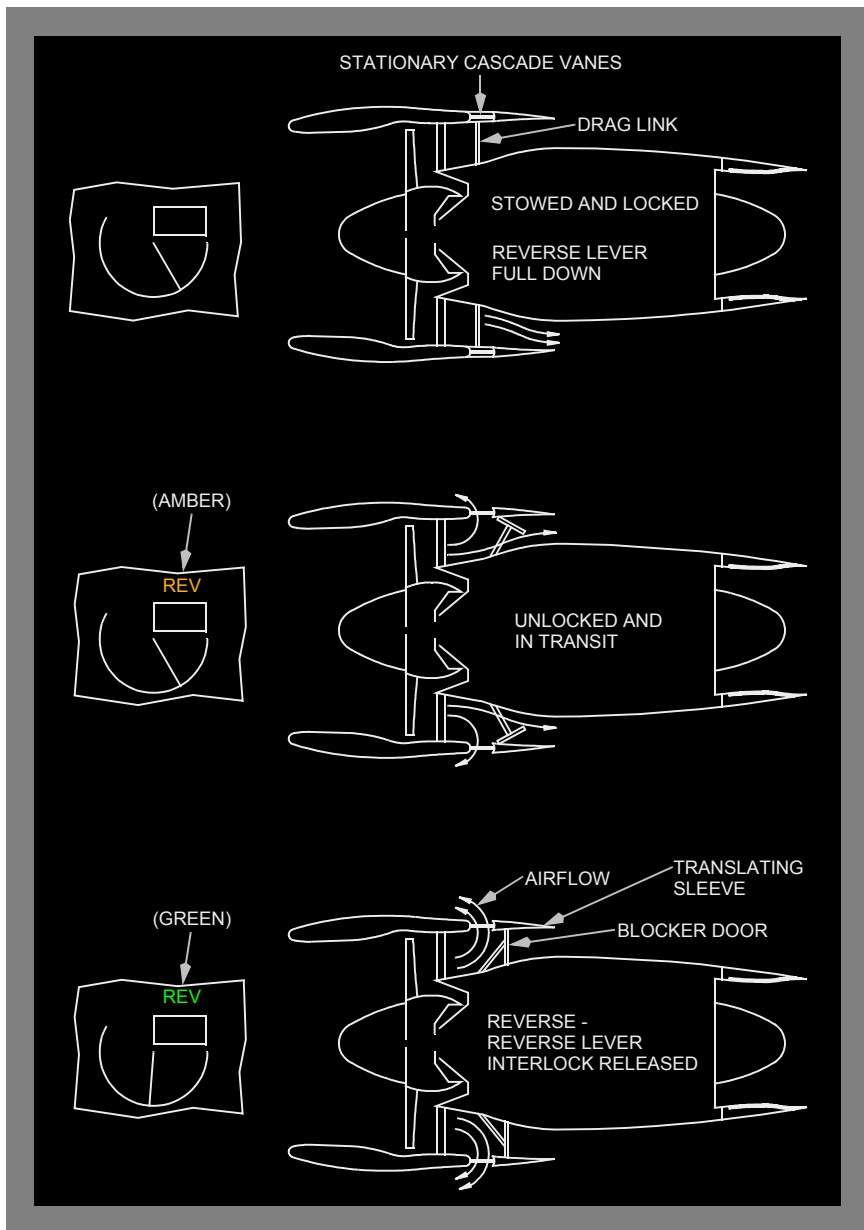

## **Airborne Vibration Monitoring System**

The airborne vibration monitoring system monitors engine vibration levels. The vibration indications are displayed on the secondary engine display. The vibration source indication is also displayed.

The airborne vibration monitoring system is primarily intended for engine condition monitoring, but it is also a useful tool for isolating and determining corrective action for engine anomalies.

When the level of the tracked vibration exceeds 2.5 units the vibration indications for both engines is displayed automatically and the engine vibration and pointer of the affected engine change color to amber.

Broadband vibration will indicate if any speed signal is lost or if a tracking filter is faulty.

Certain engine malfunctions can result in airframe vibrations from the windmilling engine. As the airplane transitions from cruise to landing, there can be multiple, narrow regions of altitudes and airspeeds where the vibration level can become severe. In general, airframe vibrations can best be reduced by descending and reducing airspeed. However, if after descending and reducing airspeed, the existing vibration level is unacceptable, and if it is impractical to further reduce airspeed, the vibration level may be reduced to a previous, lower level by a slight increase in airspeed.

---

**Introduction**

The airplane is powered by two Pratt and Whitney PW2037 engines. The engines are rated at 37,000 pounds of takeoff thrust each.

The engines are two-rotor axial flow turbfans of high compression and bypass ratio. The N1 rotor consists of the fan, a low pressure compressor and turbine section on a common shaft. The N2 rotor consists of a high pressure compressor and turbine section on a common shaft. The N1 and N2 rotors are mechanically independent. The N2 rotor drives the engine accessory gearbox.

Each engine has individual flight deck controls. Thrust is set by positioning the thrust levers. The thrust levers are positioned automatically by the autothrottle system or manually by the flight crew.

Each engine is controlled by an electronic engine controller (EEC). The EECs monitor autothrottle and flight crew inputs through the thrust levers to automatically control the engines.

Engine indications are displayed on the engine indication and crew alerting system (EICAS) display.

---

**Engine Indications**

Primary and secondary engine indications are provided. Engine indications are displayed on the EICAS display. In addition, annunciator lights and a liquid crystal standby engine indicator are provided to monitor engine operation.

**Primary Engine Indications**

EPR, N1, and EGT are the primary engine indications. The primary engine indications are always displayed on the upper EICAS display.

**Secondary Engine Indications**

N2, fuel flow, oil pressure, oil temperature, oil quantity, and engine vibration are secondary engine indications. Secondary engine indications are displayed on the lower EICAS display. The secondary engine indications can be displayed by pushing the Engine Display Switch (the ENGINE switch on the EICAS Control Panel). The secondary engine indications are automatically displayed when:

- the displays initially receive electrical power, or
- a secondary engine parameter is exceeded

## Normal Display Format

Primary engine indications and the N2 and Fuel Flow indications are digital readouts and round dial/moving pointer indications. The digital readouts display numerical values while the moving pointers indicate relative value.

Oil pressure, oil temperature, oil quantity and vibration indications are both digital readouts and vertical indication/moving pointers. All digital readouts are enclosed by boxes. The dial and vertical indications display the normal operating range, caution range, and operating limits (as applicable).

Normal operating range is displayed on a dial or vertical indication in white.

The oil pressure and oil temperature vertical indications have caution ranges displayed by amber bands. If oil pressure or oil temperature reaches the caution range, the digital readout, digital readout box, and pointer all change color to amber.

N1, EGT, N2, oil pressure, and oil temperature indications have operating limits indicated by red lines. If one of these indications reaches the red line, the digital readout, box, and pointer change color to red for that indication.

The EGT indication has a maximum continuous limit represented by an amber band. If EGT reaches the maximum continuous limit, the digital indication, box, pointer, and dial all change color to amber. The EGT indication is inhibited from changing to amber during takeoff or go-around for five minutes.

The red line limits for these parameters are not inhibited. The EGT indication has a maximum takeoff limit displayed by a red line. If EGT reaches the maximum takeoff limit, the digital indication, box, pointer and dial, all change color to red.

The maximum EPR limit is indicated by an amber line on the EPR dial. The EPR indication does not change color when maximum EPR is reached. The reference/target EPR indication displays the FMS reference or target EPR. The commanded EPR indication displays the EEC calculated EPR commanded by thrust lever position.

## Compact Display Format

In compact format, primary and secondary engine indications are combined on the same display. The EPR and N1 displays are the same as the normal displays. All other indications change to digital readouts only. If an amber or red line parameter for a digital indication is exceeded, the digital indication changes color to amber or red (as does the box that appears around an EGT indication).

Primary and secondary engine indications are displayed on EICAS in compact format whenever a CRT fails.

## Engine Secondary Data Cue

A series of blue 'v's are visible on the lower left corner of the upper EICAS CRT any time engine data is displayed on the lower EICAS CRT. If for some reason the engine data is not visible, the Status Display Switch may be used to allow the engine data to come up partially compacted on the upper EICAS CRT display.

## Engine Pressure Ratio (EPR)

Engine Pressure Ratio is the primary thrust parameter. Annunciations associated with EPR are:

- Maximum EPR
- Thrust Reference Mode
- Reference/Target EPR indication
- Reference EPR
- Assumed Temperature
- Thrust Reverser Indication
- Command Thrust Level
- Commanded EPR Sector

The maximum EPR is the maximum certified thrust limit for all phases of flight and varies with existing ambient conditions. The maximum EPR is indicated by dual amber radials on the periphery of the EPR indicator. This value is acquired from the EEC or the TMC. With the EEC operating normally, the thrust levers can be moved to the forward stop and the engines will not exceed the displayed maximum EPR.

The command thrust level is a display of thrust lever position and appears as an extension of the EPR pointer when the engine is stabilized. A change in thrust lever position moves the command thrust level and displays the commanded thrust on the EPR indicator. This allows for precise thrust control.

The command EPR sector is a display of the momentary difference between the command thrust level and actual EPR and appears as a white band on the EPR indicator. As the engine accelerates or decelerates to the command thrust level the command EPR sector is erased. This allows for monitoring of engine acceleration and deceleration.

Thrust reverser indication (REV) is displayed above the EPR indicator when the reverser is activated. The annunciation is amber when the reverser is unlocked or in transit. When the reverser is fully deployed, the annunciation changes color to green and the forward thrust reference displays are inhibited.

## Thrust Management Computer (TMC)

The thrust management computer calculates a reference EPR based on existing pressure altitude and ambient temperature data from the air data system for the following modes:

- TO – takeoff
- TO 1 – takeoff one
- TO 2 – takeoff two
- D-TO – assumed temperature takeoff
- CLB – climb
- CLB 1 – climb one
- CLB 2 – climb two
- CRZ – cruise
- CON – continuous
- GA – go-around

These modes can be selected with the thrust mode select panel (TMSP). The inner thrust reference set control on the EICAS control panel must be pushed in for the thrust reference modes to be displayed on EICAS. The selected thrust reference mode is displayed above the EPR indicators. The digital reference EPR is displayed adjacent to the mode display. When the EPR bug is green, it is positioned on the EPR scale at the same value as the digital reference EPR.

The thrust mode select switches provide the capability of selecting different thrust modes for each phase of flight. The TO/GA switch is used to select takeoff thrust on the ground and go-around thrust inflight.

The 1 and 2 switches are used to select a reduced takeoff thrust rating or reduced climb thrust. When reduced takeoff thrust rating one or two is selected, this automatically preselects the associated reduced climb one or two. The CLB switch is used to select climb thrust inflight. If reduced climb thrust one or two was preselected, pushing the climb switch inflight selects CLB 1 or CLB 2.

The assumed temperature for a reduced thrust takeoff can be set by:

- using the assumed temperature selector on the TMSP
- entering the assumed temperature into the CDU TAKEOFF REF page

The 1 and 2 switches are used to select reduced climb thrust. Reduced climb thrust one or two can be preselected in conjunction with takeoff or assumed temperature takeoff thrust prior to takeoff. The CLB switch is used to select climb thrust inflight. If reduced climb thrust one or two was preselected, pushing the climb switch inflight selects CLB 1 or CLB 2.



The CON switch is used to select maximum continuous thrust inflight. The CRZ switch is used to select cruise thrust inflight. The assumed temperature selector or the CDU is used to set assumed temperatures when reduced takeoff thrust is desired.

To manually set reference EPR values the thrust reference set control is pulled out, MAN appears as the thrust mode annunciation and the EPR bug slews to 1.55. manual reference EPR values can then be set by rotating the inner control. The outer control of the thrust reference set control is used to select the desired EPR indicator(s) for manual EPR display. The autothrottles do not respond to manually set reference EPR values. When the inner control is pulled out, the autothrottles remain in the active TMC mode. The TMSP remains operable and the autothrottles respond to TMSP mode changes, but selected thrust reference mode displays are inhibited.

When the AFDS VNAV mode is engaged, the EPR bug may be magenta. When the EPR bug is magenta, it is positioned at a nominal target EPR by the FMC, which may not correlate with the digital reference EPR. In VNAV, the FMC controls thrust mode selection automatically to meet thrust requirements for the active vertical mode of operation. The FMC does not have the capability to select reduced climb thrust values, these values must be selected manually with the 1 or 2 TMSP switches.

The thrust reference mode, reference EPR and target EPR indication are not displayed when the reversers are fully deployed.

## **Reduced Takeoff Thrust**

### **Assumed Temperature Takeoff**

The Thrust Management Computer calculates the Reference EPR for Assumed Temperature reduced thrust takeoff. The assumed temperature can be entered manually on the CDU takeoff reference page or selected with the assumed temperature selector on the TMSP. The assumed temperature is displayed above the Thrust Reference Mode.

When the assumed temperature selector on the TMSP is initially rotated clockwise, a reference temperature is displayed on EICAS. This temperature also appears on the CDU takeoff reference page. Further clockwise rotation of the selector increases the assumed temperature by one degree centigrade per click. The reduced thrust annunciation of D-TO appears when the assumed temperature selected is above ambient. If the ambient temperature is greater than the initially displayed reference temperature, D-TO and reduced thrust occur when the assumed temperature selected exceeds ambient.

Counterclockwise rotation of the selector reduces the assumed temperature by one degree centigrade per click.

---

Assumed temperature takeoff thrust is limited to a 25% reduction of takeoff thrust or selected climb thrust, whichever is the greater thrust value. When the limit is reached, further adjustment to the assumed temperature by rotating the assumed temperature selector on the TMSP or changing the value entered in the CDU TAKEOFF REF page does not change the displayed assumed temperature or reference thrust value.

## Reduced Climb Thrust

Climb one or two can be preselected in conjunction with the TO, D-TO, CON and CRZ Thrust Reference modes. Reduced climb thrust is available throughout the airplanes operational envelope.

Two levels of reduced climb thrust are available with the 1 and 2 mode switches on the Thrust Mode Select Panel. Climb 1 is approximately 92% of climb thrust and climb 2 is approximately 85% of climb thrust.

---

## Electronic Engine Control (EEC)

The thrust system consists of a dual channel (primary and secondary), full authority Electronic Engine Control unit without any hydromechanical backup. The EEC sets thrust by controlling EPR based on thrust lever position. EPR is commanded by positioning the thrust levers either automatically with the autothrottles, or manually by the flight crew. Each EEC is powered, when the engines are operating, by a dedicated permanent magnet alternator (PMA) independent of airplane electrical power.

The EEC continuously computes the maximum limits for thrust. Maximum rated thrust is available in any phase of flight by moving the thrust levers to the full forward positions. Maximum EPR represents the maximum rated thrust available from the engine. These values are displayed by the position of the dual amber radials on the EPR display.

During normal EEC operation, the primary channel provides inputs to the fuel control to drive the engine to an EEC computed Command Thrust Level. The EEC computes this EPR as a percentage of its maximum limit computation. The percentage is varied with thrust lever position, such that at full throttle, the percentage is 100%. During rapid throttle lever movements, the difference between the engines actual EPR and the EECs commanded EPR is displayed as the Command Sector on the EICAS EPR display.

## EPR and N1 Control Modes

The primary channel can set thrust using EPR, N1 or N2 control mode while the secondary channel uses N1 or N2 control mode only. Manual selection of the control mode or channel is not directly available to the flight crew.

Both engines normally operate in the primary channel EPR mode to control thrust. Automatic switching from the primary to secondary channel will occur when the primary channel becomes incapable of control. Automatic switching will also occur when the engine is shut down inflight. Subsequent engine shutdowns and restarts will alternate between the primary and secondary channels.

If the EEC is not provided adequate parameters to maintain EPR control, an N1 control mode is used by the EEC to control thrust. When the EEC reverts to N1 mode control, there may be a small thrust increase and the EPR display will blank.

The EICAS advisory message ENGINE CONTROLS displays when faults are detected in the engine control systems.

## **N2 Control Mode**

If EEC operation in both the EPR and N1 control modes is not possible, an N2 control mode is used by the EEC to control thrust. The ENG LIMIT PROT light illuminates and the EICAS advisory message L or R ENG LIM PROT displays to indicate that the EEC is operating in the N2 control mode. Automatic thrust limit protection is not available. Engine acceleration time will be affected and thrust lever stagger will develop. Inflight idle speed between the two engines may be noticeably different. Thrust is controlled in a manner similar to conventional fuel controls. The L or R ENG LIM PROT advisory message will change to a caution if the thrust lever is advanced to the full forward position.

Since reverse thrust is not limited by the EEC in this mode, EGT and rotor speeds must be monitored to prevent exceeding red lines.

## **Engine Stator Vanes**

Several stages of the high pressure compressor stator vanes are positioned by the variable stator vane actuator which is controlled by the EEC. The variable positioning improves compressor performance and helps prevent compressor surge.

The EICAS caution message L or R ENG STATOR message displays if both channels of the EEC are unable to control the stator vane actuator. Any thrust lever movement, changes to the air conditioning pack control or recirculation fan or changes in engine/wing anti-ice configuration may cause engine flameout. If the engine fails and the L or R ENG STATOR message remains displayed, restart is not possible.

## **Overspeed Protection**

The EEC also provides N1 and N2 red line overspeed protection. If N1 or N2 approaches overspeed, the EEC commands reduced fuel flow. The EEC does not provide EGT over temperature protection.

---

If engine limit protection is not available, advancing the thrust levers full forward should be considered only during emergency situations when all other available actions have been taken and terrain contact is imminent.

## Idle Selection

There are three engine idle speeds: ground minimum idle, inflight minimum idle and approach idle. The fuel control unit selects these idle speeds automatically. Ground minimum idle is a lower thrust than inflight minimum idle and selected for ground operations. Inflight minimum idle is a lower thrust than approach idle and is for most phases of flight. Approach idle is selected whenever this higher idle setting is required for proper system operation.

---

## Engine Start and Ignition System

Air from the pneumatic duct is used to power the air driven starter, which is connected to the N2 rotor. The starter air source may be from a ground cart, APU or the other running engine.

The engine start selectors control the start valves. Ignition and fuel flow are controlled through the fuel control switches.

A maximum start limit line (red) is displayed on the EGT indication when the fuel control switch is moved to CUT OFF. It remains displayed after the fuel control switch is moved to RUN until the engine is stabilized at idle. The EGT indication changes color to red if the EGT start limit is reached during starting.

## Engine Start

Pushing in and rotating the engine start selector to the GND position, opens the start valve, engages the air driven starter to the N2 rotor and closes the engine bleed air valve if it is open. The VALVE light illuminates and the EICAS advisory message L or R ENG STARTER displays to indicate the start valve failed to open. As N2 rotation accelerates to maximum motoring RPM, the fuel control switch is positioned to RUN. Maximum motoring speed is reached when acceleration is less than approximately 1% in 5 seconds. Minimum N2 for selecting RUN is indicated by a magenta fuel on command bug. The fuel control switch opens the spar and engine fuel valves allowing the fuel to flow to the fuel control unit and activates the selected ignition. The ignition selector may be used to select BOTH, or either 1 or 2 ignitor(s). Normally, only one ignitor is used for ground start while both ignitors are used for inflight starts. At approximately 50% N2, the engine start selector automatically moves to the AUTO position. The starter automatically cuts out and the start valve closes stopping the flow of air to the starter. This allows the engine bleed valve to return to a position that agrees with the engine bleed air switch. If the start valve fails to close automatically, the corresponding valve light will illuminate and the EICAS caution message L or R STARTER CUTOFF will display. The engine start selector must be manually moved to the AUTO or OFF position to terminate starter operation.

## Starter Operation

Continuous operation of the starter must be limited in accordance with the following starter duty cycles:

### Normal Duty Cycle

- Up to 2 minutes continuous operation then run down to zero N2, followed by:
- Up to a further 2 minutes continuous operation then run down to zero N2, followed by:
- Up to 2 minutes continuous operation then run down to zero N2 and allow to cool for 15 minutes

### Re-engagement Speed

- 0% N2 Recommended
- 0–20% N2 Normal

Re-engagement is not recommended above 20% N2 except in case of fire. Re-engagement above 30% N2 may result in starter or gearbox damages.

## **In-Flight Start**

In-flight start envelope information is displayed on the EICAS Primary Display when an engine is not running in flight, the respective engine fire switch is not pulled and both EICAS Primary and Secondary displays are selected. The inflight start envelope indicates the airspeed range necessary to ensure an inflight start at the current flight level. If the current flight level is above the maximum start altitude, the maximum start altitude and respective airspeed range are displayed.

A crossbleed start indication (X-BLD) appears above the N2 indication and a fuel on command bug is displayed if airspeed is below that recommended for a windmilling start.

## **Engine Ignition**

Each engine has two ignitors. Dual ignitors are always used for inflight starts. Main AC power is the normal power source for ignition. Standby AC power provides a backup source.

## Engine Start and Ignition System Schematic

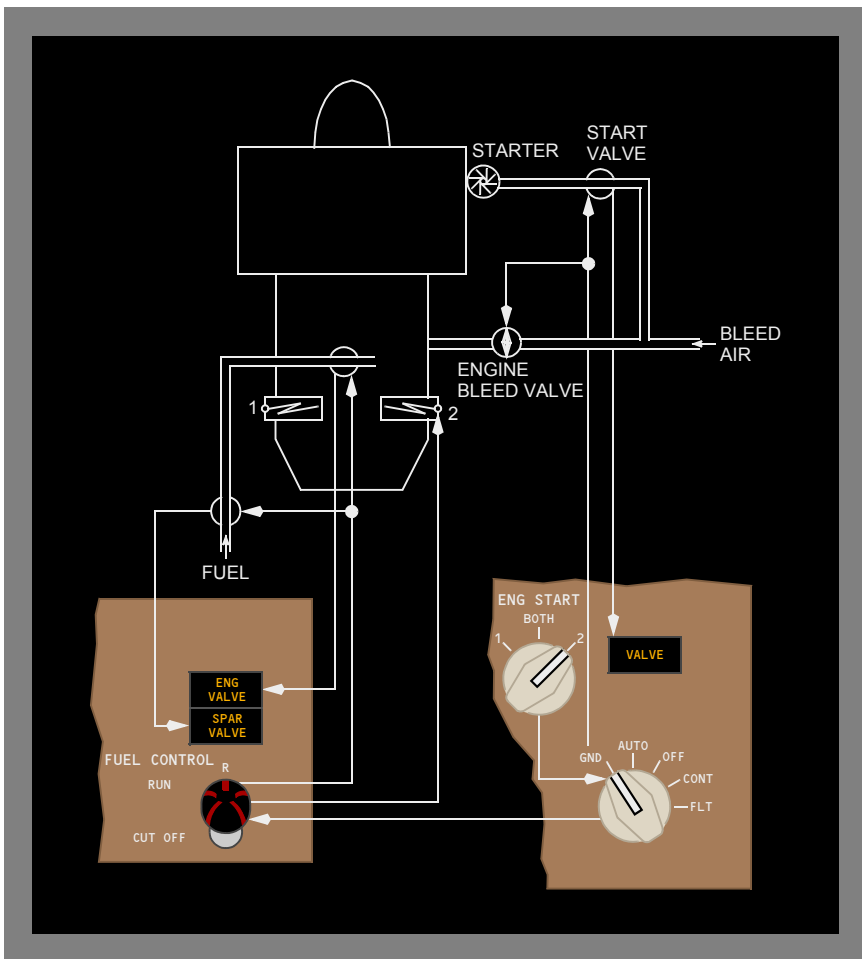

## Engine Fuel System

Fuel is supplied by fuel pumps located in the fuel tanks. The fuel flows through a spar fuel valve located in the main tank. It then passes through the first stage engine fuel pump where additional pressure is added. It flows through a fuel/oil heat exchanger where it is preheated. A fuel filter removes contaminants. The second stage of the engine fuel pump adds more pressure before the fuel reaches the fuel control unit. The fuel is then controlled to meet the existing thrust requirements. The fuel then flows through the engine fuel valve and fuel flow meter before entering the engine.

## Fuel control Unit

The engine fuel control system incorporates a fuel control unit which operates in conjunction with the EEC. The fuel control system schedules fuel flow to meet engine thrust requirements as dictated by the thrust lever position and the specific engine operating conditions. The EEC controls the metered fuel and prevents engine limits from being exceeded.

## Engine and Spar Valves

The spar and engine fuel valves allow fuel flow to the engine when both valves are open. The valves open when the engine fire switch is IN and the fuel control switch is in the RUN position. Both valves close when either the fuel control switch is in CUT OFF or the engine fire switch is OUT.

The ENG VALVE and SPAR VALVE lights illuminate momentarily as the valves open or close. If the valves do not agree with the fuel control switch or the respective fire switch position after allowing for the normal operating time, the lights remain illuminated and the EICAS advisory message L or R FUEL SPAR VAL or L or R ENG FUEL VAL displays.

## Fuel Filter

The fuel is filtered by a filter with bypass capabilities. If the filter becomes clogged with contaminants, fuel will bypass the filter allowing contaminated fuel to enter the fuel control unit.

The L or R ENG FUEL FILT EICAS advisory message displays to indicate the affected engine filter is clogged and is approaching a level sufficient to cause filter bypass.

Erratic engine operation and flameout may occur due to fuel contamination.



## Fuel Flow Measurement

Fuel flow is measured after passing through the engine fuel valve. Fuel flow is displayed on the secondary engine display. Fuel flow information is also provided to the FMS.

## Engine Fuel System Schematic

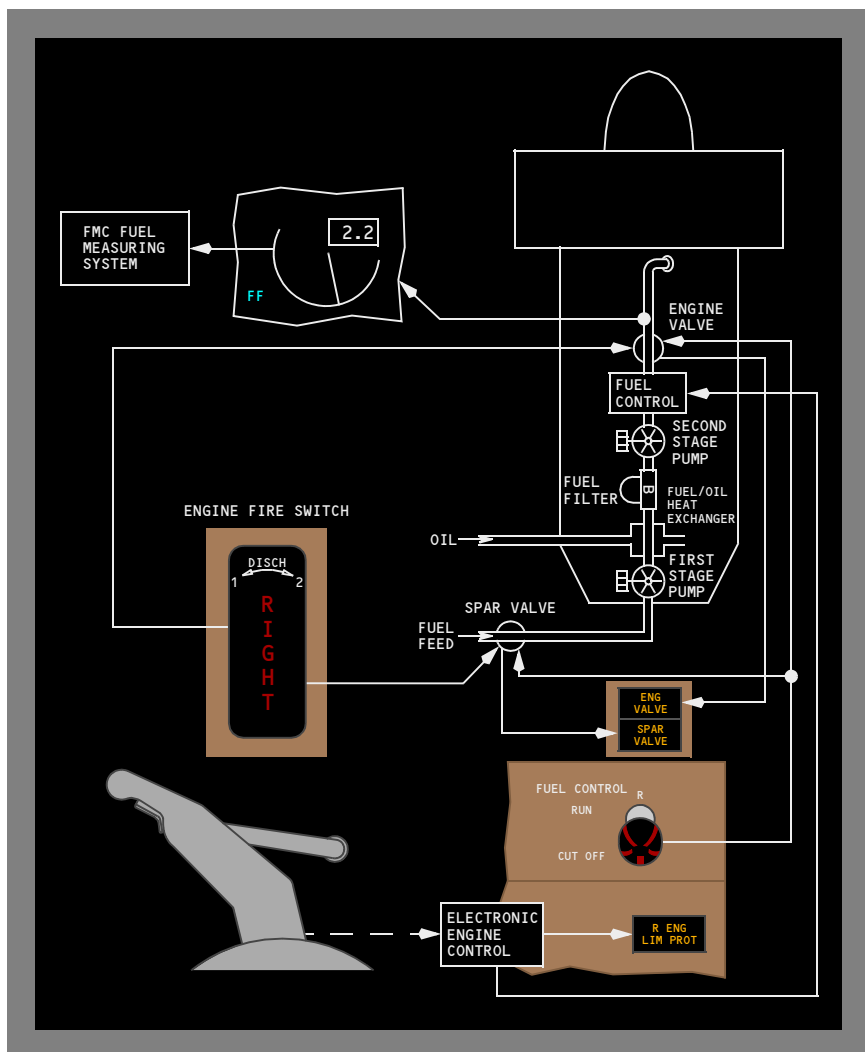

## Engine Oil System

The oil system provides pressurized oil to lubricate and cool the engine main bearings, gears and accessory drives. The oil system also provides automatic fuel heating for fuel system icing protection.

As an engine is started, a quantity of oil will shift to the engine bearing compartments and gearbox, and will not return to the oil reservoir until the engine is shut down. In addition, oil quantity and oil temperature will tend to vary with engine RPM such that, as RPM is increased, quantity and temperature increase. As RPM is decreased, quantity and temperature decrease.

Oil is pressurized by a main (engine-driven) oil pump. From the pump, the oil flows through the oil filter where contaminants are removed. Should the oil filter become saturated with contaminants, oil will automatically bypass the filter. The EICAS advisory message L or R OIL FILTER displays indicating the oil filter is bypassed. The oil flows through the fuel-oil heat exchanger where fuel is used as the heat sink, and is then delivered to the engine main bearings, gears, and accessory drives. The oil is then returned to the reservoir.

Oil pressure, temperature, and quantity are displayed on the secondary engine display.

Oil pressure is measured prior to entering the engine. The L or R ENG OIL PRESS light illuminates and the L or R ENG OIL PRESS EICAS advisory message displays to indicate the oil pressure is low.

When the oil pressure is at or below the variable limits, the EICAS indication changes to amber.

Oil temperature is measured after leaving the engine, prior to entering the reservoir.

There is no minimum oil quantity limit (no amber or red line limit). There are no operating limitations for the engine oil quantity; therefore, there are no flight crew procedures based solely on a response to low oil quantity.

## Engine Oil System Schematic

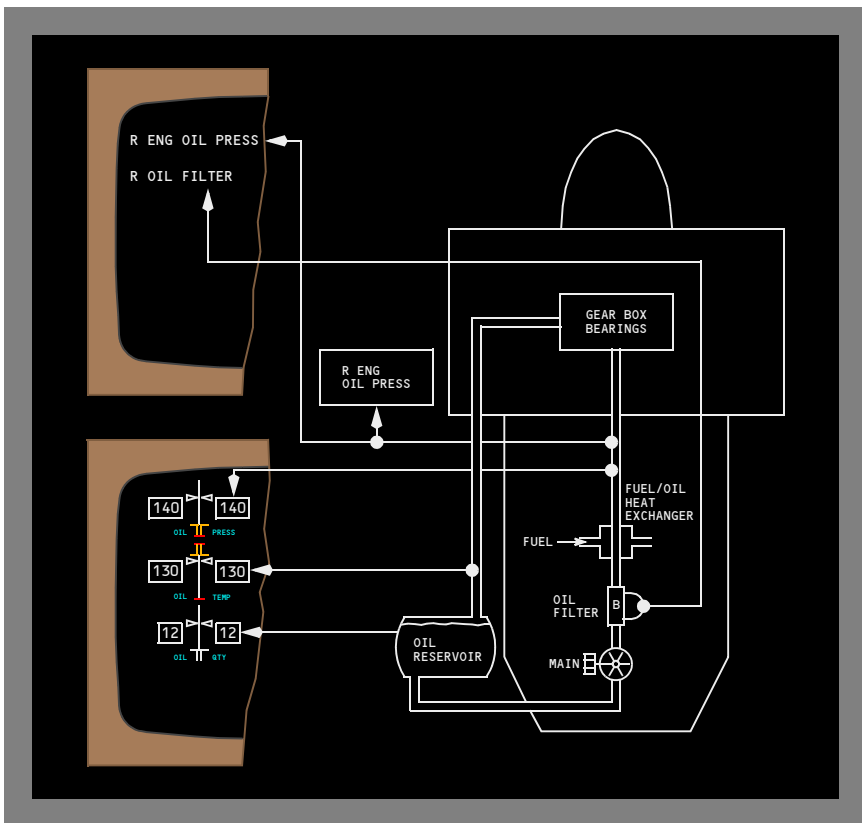

## Thrust Reverser System

Each engine has a hydraulically actuated fan air thrust reverser. Reverse thrust is available only on the ground.

The reverse thrust levers can be raised only when the forward thrust levers are in the idle position. An interlock stop limits thrust to idle reverse while the reverser is in transit.

The EECs control thrust limits during reverser operation.

When the reverse thrust levers are pulled aft to the interlock position:

- the autothrottle disengages
- the auto speedbrakes deploy

When the reverser system is activated:

- reverser isolation valve opens allowing the reverser translating sleeves to hydraulically move aft
- the fan flow blocker doors rotate into place to direct fan air through stationary cascade guide vanes
- the reverser indication (REV) is displayed above each digital EPR indication (REV is displayed in amber when the reverser is in transit)

When the interlock releases:

- the reverse thrust levers can be raised to the maximum reverse thrust position
- the REV indication changes to green when the reverser is fully deployed

Pushing the reverse thrust levers to the full down position retracts the reversers to the stowed and locked position. While the reverser is in transit, the REV annunciation changes color to amber. The thrust levers cannot be moved forward until the reverse thrust levers are fully down. When the reverser reaches the stowed position, the amber REV annunciation disappears.

On the ground, the L or R REV ISLN VAL EICAS advisory message is displayed when a fault exists in the reverser system. If this fault is detected above 80 knots during takeoff, or in flight, the message is inhibited until after landing. An electro-mechanical lock prevents uncommanded reverser deployment in the event of additional system failures.

## Thrust Reverser Schematic

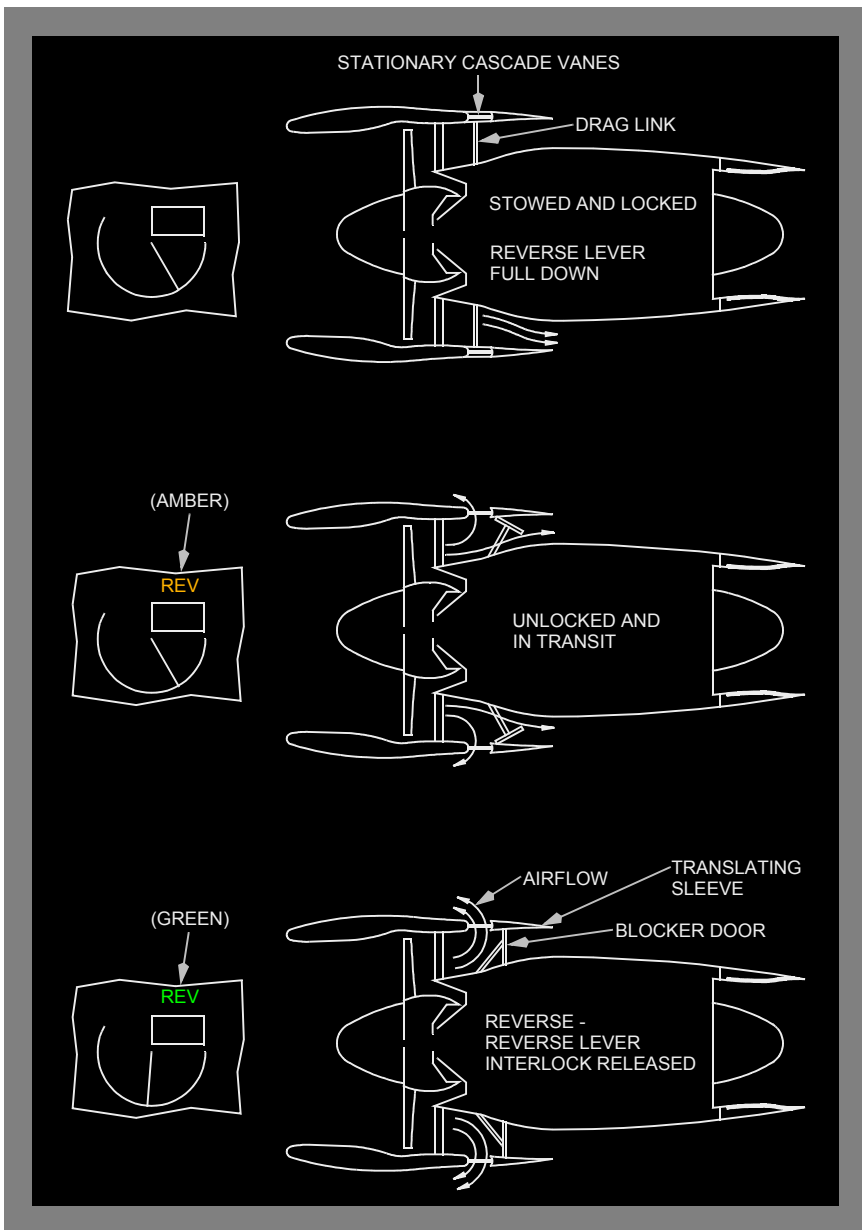

## **Airborne Vibration Monitoring System**

The airborne vibration monitoring system monitors engine vibration levels. The vibration indications are displayed on the secondary engine display. The vibration source indication is also displayed.

The airborne vibration monitoring system is primarily intended for engine condition monitoring, but it is also a useful tool for isolating and determining corrective action for engine anomalies. Since there are no operating limitations for the airborne vibration monitoring system, there are no specific flight crew actions (or procedures) based solely on vibration indication. High N1 vibration indication would most likely be accompanied by tactile vibration. This is not the case with high N2 vibration indication. N1 and N2 high vibrations may be accompanied by anomalies in other engine parameters and will usually respond to thrust lever adjustment.

Certain engine malfunctions can result in airframe vibrations from the windmilling engine. As the airplane transitions from cruise to landing, there can be multiple, narrow regions of altitudes and airspeeds where the vibration level can become severe. In general, airframe vibrations can best be reduced by descending and reducing airspeed. However, if after descending and reducing airspeed, the existing vibration level is unacceptable, and if it is impractical to further reduce airspeed, the vibration level may be reduced to a previous, lower level by a slight increase in airspeed.

---

**Introduction**

The auxiliary power unit (APU) is a self-contained gas turbine engine located in the airplane tail cone. The APU air inlet door is located between the horizontal and vertical stabilizers on the right side of the airplane.

While the primary purpose of the APU is to supply electrical power and bleed air on the ground before engine start, the APU can also be started inflight, and operated up to the airplane maximum certified altitude.

Electrical power has priority over bleed air. Electrical power is available throughout the airplane operating envelope. In flight, APU bleed air is available up to approximately 17,000 feet.

Refer to the following chapters for additional information:

- Chapter 2, Air Systems, for a description of APU bleed air operation
- Chapter 6, Electrical, for a description of APU electrical operation
- Chapter 8, Fire Protection, for a description of the APU fire protection system
- Chapter 12, Fuel, for a description of the APU fuel system

---

**APU Operation****APU Start**

APU start requires both the APU battery and the aircraft main battery.

Fuel for the APU is supplied from the left manifold. A dedicated DC fuel pump is energized when the APU Selector is placed in the ON position if no AC power is available. When AC power is available, the left forward AC fuel pump is signaled to operate regardless of its switch position, and the DC fuel pump is signaled off.

Rotating the APU selector to START begins the automatic start sequence. The APU fuel valve opens and at the same time the APU inlet door begins to open. A fuel pump also begins to operate.

When the inlet door is fully open, the electric starter engages. After the APU reaches the proper speed, ignition and fuel are provided, and the APU accelerates to its normal operating speed.

The starter duty cycle is a maximum of three consecutive starts or attempts within a sixty minute period.

## **APU Run**

When the APU RUN light illuminates, the APU may be used to supply electrical power and bleed air.

## **APU Shutdown**

To protect the unit from thermal shock, the APU control system incorporates a time-delay feature permitting APU cooling before shutdown. If the APU is supplying pneumatic power, rotating the APU selector to OFF begins the shutdown cycle by closing the APU bleed air valve. If the APU bleed valve has been closed for a sufficient length of time when the selector is moved to OFF, the APU shuts down without delay.

If the selector is inadvertently moved to OFF, but the RUN light is still illuminated, momentarily moving the selector to START cancels the shutdown signal.

## **Protection System**

On the ground, placing the Battery Switch OFF also results in an APU shutdown. This is not a recommended procedure however, because while the APU will go through a cooldown cycle, APU fire detection may not be available. In flight, Battery Switch position does not affect APU operation.

An amber FAULT light on the APU control panel illuminates whenever a fault is sensed. In addition, an EICAS advisory message APU FAULT is displayed, and the APU shuts down immediately. Fault detection circuitry is reset by positioning the APU Selector to OFF.

The FAULT light also comes on when the APU fuel valve is not in the commanded position. Therefore, during APU start and shutdown, the light illuminates momentarily. The EICAS advisory APU FUEL VAL appears if the valve fails to reach the commanded position.

With the APU Selector positioned to OFF, both the APU FAULT light and the associated APU FAULT EICAS message are inhibited. Only a failure of the APU fuel valve to close causes the APU FAULT light and the associated APU FUEL VAL message.



**Engines, APU EICAS Messages**

The following EICAS messages can be displayed.

**APU**

Message	Level	Light	Aural	Condition
APU FAULT	Advisory	FAULT		The APU has automatically shut down
APU FUEL VAL	Advisory	FAULT		The APU fuel valve position disagrees with the commanded position

**Engine****Control**

Message	Level	Light	Aural	Condition
L ENG EEC R ENG EEC	Advisory	INOP		The electronic engine control is inoperative
L EEC OFF R EEC OFF	Caution	INOP	Beeper	The electronic engine control switch is OFF
L ENG LIMITER R ENG LIMITER	Advisory	INOP		The engine limiter is inoperative
L ENG SHUTDOWN R ENG SHUTDOWN	Caution		Beeper	Engine was shutdown by the fuel control switch or fire switch

**Fuel**

Message	Level	Light	Aural	Condition
L ENG FUEL FILT R ENG FUEL FILT	Advisory			An impending fuel filter bypass condition exists on the affected engine
L ENG FUEL VAL R ENG FUEL VAL	Advisory	ENG VALVE		The engine fuel valve position disagrees with commanded position

Message	Level	Light	Aural	Condition
L FUEL SPAR VAL R FUEL SPAR VAL	Advisory	SPAR VALVE		The fuel spar valve position disagrees with commanded position

**Oil**

Message	Level	Light	Aural	Condition
L OIL FILTER R OIL FILTER	Advisory			Affected engine oil filter contamination has been detected
L ENG OIL PRESS R ENG OIL PRESS	Advisory	L ENG OIL PRESS R ENG OIL PRESS		Engine oil pressure is low

**Start**

Message	Level	Light	Aural	Condition
L ENG STARTER R ENG STARTER	Advisory	VALVE		Engine starter valve is not in the commanded position
L STARTER CUTOUT R STARTER CUTOUT	Caution	VALVE	Beeper	The engine start valve is open when commanded closed

**Thrust Reverser**

Message	Level	Light	Aural	Condition
L REV ISLN VAL R REV ISLN VAL	Advisory			Fault is detected in the affected engine reverser system

**Engines, APU EICAS Messages**

The following EICAS messages can be displayed.

**APU**

Message	Level	Light	Aural	Condition
APU FAULT	Advisory	FAULT		The APU has automatically shut down
APU FUEL VAL	Advisory	FAULT		The APU fuel valve position disagrees with the commanded position

**Engine****Control**

Message	Level	Light	Aural	Condition
ENGINE CONTROLS	Advisory			Faults are detected in the engine controls system
L ENG LIM PROT R ENG LIM PROT	Caution or Advisory	ENG LIM PROT		EEC is operating in N2 mode
L ENG SHUTDOWN R ENG SHUTDOWN	Caution		Beeper	Engine was shutdown by the fuel control switch or fire switch
L ENG STATOR R ENG STATOR	Caution		Beeper	The EEC is not capable of controlling the stator vane actuator

**Fuel**

Message	Level	Light	Aural	Condition
L ENG FUEL VAL R ENG FUEL VAL	Advisory	ENG VALVE		The engine fuel valve position disagrees with commanded position

Message	Level	Light	Aural	Condition
L FUEL SPAR VAL R FUEL SPAR VAL	Advisory	SPAR VALVE		The fuel spar valve position disagrees with commanded position
L ENG FUEL FILT R ENG FUEL FILT	Advisory			An impending fuel filter bypass condition exists on the affected engine

**Oil**

Message	Level	Light	Aural	Condition
L OIL FILTER R OIL FILTER	Advisory			Affected engine oil filter contamination has been detected
L ENG OIL PRESS R ENG OIL PRESS	Advisory	L ENG OIL PRESS R ENG OIL PRESS		Engine oil pressure is low

**Start**

Message	Level	Light	Aural	Condition
L ENG STARTER R ENG STARTER	Advisory	VALVE		Engine start valve is not in the commanded position
L STARTER CUTOUT R STARTER CUTOUT	Caution	VALVE	Beeper	The engine start valve is open when commanded closed

**Thrust Reverser**

Message	Level	Light	Aural	Condition
L REV ISLN VAL R REV ISLN VAL	Advisory			Fault is detected in the affected engine reverser system

# DO NOT USE FOR FLIGHT

757 Flight Crew Operations Manual

## Fire Protection

## Chapter 8

### Table of Contents

### Section 0

<b>Controls and Indicators</b> .....	<b>8.10</b>
Engine Fire Protection .....	8.10.1
Engine Fire Panel .....	8.10.1
Fuel Control Switches .....	8.10.2
Fire Warning Light .....	8.10.2
Cargo and APU Fire Protection .....	8.10.3
Cargo and APU Fire Panel .....	8.10.3
Wheel Well Fire Light .....	8.10.4
APU Ground Control Fire Protection Panel .....	8.10.5
Fire/Overheat Test Panel .....	8.10.6
<b>System Description</b> .....	<b>8.20</b>
Introduction .....	8.20.1
Engine Fire Protection .....	8.20.1
Engine Fire and Overheat Detection .....	8.20.1
Engine Fire Warning .....	8.20.1
Engine Overheat Caution .....	8.20.2
Engine Fire Extinguishing .....	8.20.2
Engine/APU Fire and Override Switches .....	8.20.2
APU Fire Protection .....	8.20.2
APU Fire Detection .....	8.20.3
APU Fire Warning .....	8.20.3
APU Fire Extinguishing .....	8.20.3
Main Gear Wheel Well Fire Protection .....	8.20.4
Main Gear Wheel Well Fire Detection .....	8.20.4
Main Gear Wheel Well Fire Warning .....	8.20.4
Cargo Compartment Fire Protection .....	8.20.4
Cargo Compartment Smoke Detection .....	8.20.4
Cargo Compartment Fire Warning .....	8.20.4
Cargo Compartment Fire Extinguishing .....	8.20.5

---

Lavatory Fire Protection . . . . .	8.20.5
Lavatory Fire Detection and Annunciation . . . . .	8.20.5
Lavatory Fire Extinguishing . . . . .	8.20.5
Fire and Overheat Detection System Fault Test . . . . .	8.20.6
<b>System EICAS Messages . . . . .</b>	<b>8.30</b>
Fire Protection EICAS Messages . . . . .	8.30.1

## Engine Fire Protection

### Engine Fire Panel

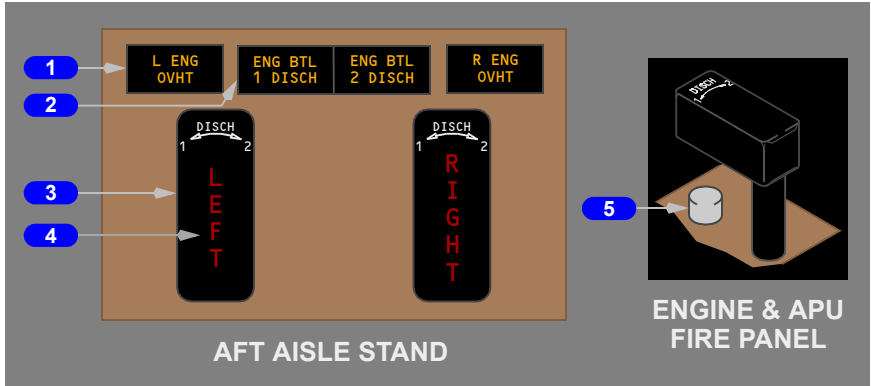

#### 1 Engine Overheat (L/R ENG OVHT) Lights

Illuminated (amber) – engine overheat is detected

#### 2 Engine Fire Bottle Discharged (ENG BTL DISCH) Lights

Illuminated (amber) – the extinguisher bottle is discharged or has low pressure

#### 3 Engine Fire Switches

In – normal position, mechanically locked; unlocks if fire warning activated

Out – closes the associated engine and spar fuel valves, and

- closes the associated engine bleed air valves
- trips the associated engine generator off
- shuts off hydraulic fluid to the associated engine-driven hydraulic pump
- arms both engine fire extinguisher bottles

Rotate to position 1 or 2 – discharges the selected fire extinguisher into the engine

#### 4 Engine Fire Warning Lights

Illuminated (red) – an engine fire is detected

#### 5 Engine and APU Fire Override Switches

Push – unlocks the respective engine or APU fire switch

## Fuel Control Switches

### Option - Rolls Royce Engines

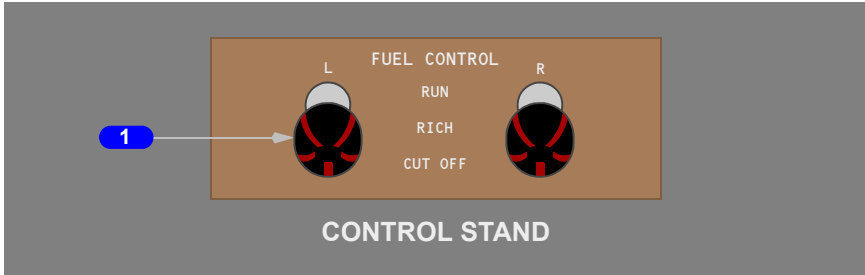

### Option - Pratt and Whitney Engines

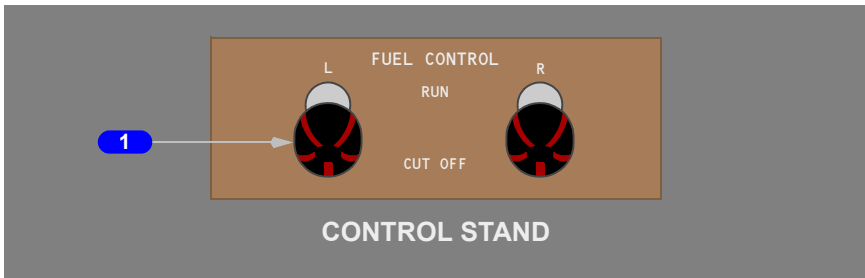

### **1** FUEL CONTROL Switch Fire Warning Lights

Illuminated (red) – an associated engine fire is detected

## Fire Warning Light



### **1** Discrete FIRE Warning Light

Illuminated (red) – an engine, APU, wheel well, or cargo fire is detected



## Cargo and APU Fire Protection

### Cargo and APU Fire Panel

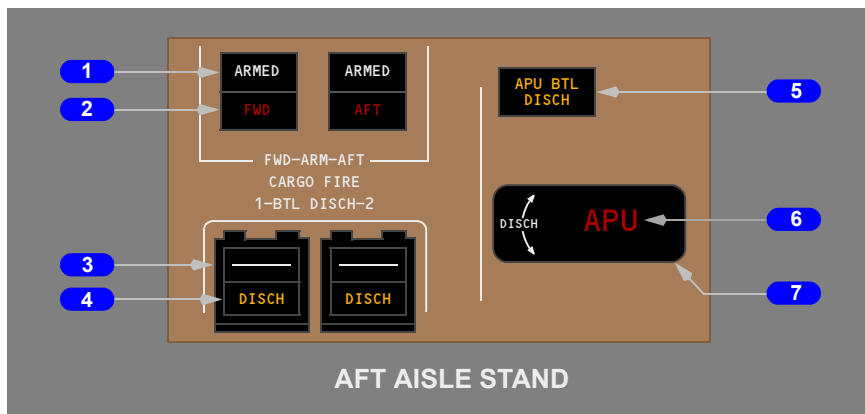

#### **1 CARGO FIRE ARM Switches**

FWD ARMED –

- arms all cargo fire extinguisher bottles for the forward compartment
- turns off both recirculation fans

AFT ARMED –

- arms all cargo fire extinguisher bottles for the aft compartment
- turns off the right recirculation fan

Off – normal position

**Note:** Both forward and aft compartments can be armed at the same time.

#### **2 CARGO FIRE Warning Lights**

Illuminated (red) – smoke is detected in associated cargo compartment

#### **3 CARGO FIRE Bottle Discharge (BTL DISCH) Switches**

Push – discharges the respective fire extinguisher bottle into the ARMED cargo compartment

#### **4 CARGO FIRE Bottle Discharged (DISCH) Lights**

Illuminated (amber) – the associated extinguisher bottle is discharged or has low pressure

#### **5 APU Fire Bottle Discharged (APU BTL DISCH) Light**

Illuminated (amber) – the extinguisher bottle is discharged or has low pressure

---

**6 APU Fire Warning Light**

Illuminated (red) – an APU fire is detected

**7 APU Fire Switch**

In – normal position, mechanically locked; unlocks automatically if fire warning.

Out – closes the APU fuel valve, and

- trips the APU generator off
- closes the APU air supply valve
- shuts down the APU
- arms the APU fire extinguisher bottle

Rotate – either direction discharges the APU fire extinguisher into the APU compartment

---

**Wheel Well Fire Light**

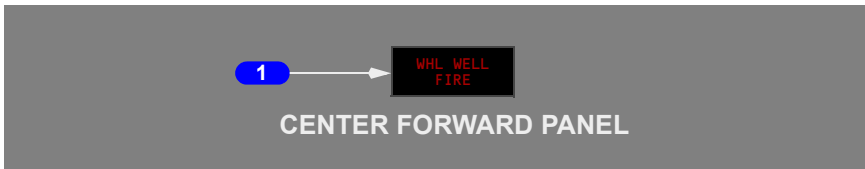

**1 Wheel (WHL) WELL FIRE Warning Light**

Illuminated (red) – a fire is detected in one or both of the main gear wheel wells

## APU Ground Control Fire Protection Panel

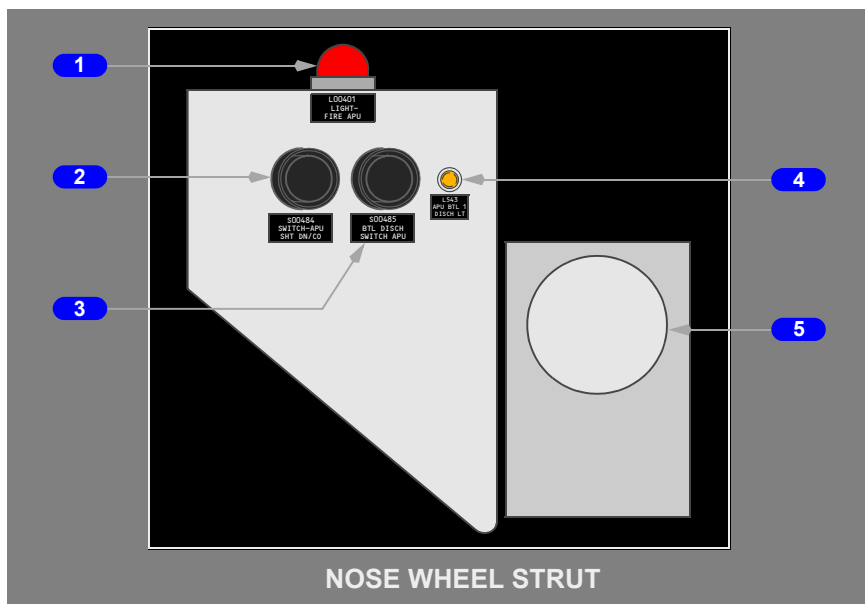

### 1 APU FIRE Light

Illuminated (red) – an APU fire is detected

The APU automatically shuts down for a detected fire

APU fire extinguisher bottle is automatically discharged for an APU fire when the airplane is on the ground and both engines shut down.

### 2 APU Shut Down (SHT DN) Switch

Push –

- closes the APU fuel valve and trips the APU generator off
- closes the APU air supply valve and shuts down the APU
- arms the APU fire extinguisher bottle

### 3 APU Bottle Discharge (BTL DISCH) Switch

Push – discharges the APU fire extinguisher bottle into the APU compartment

### 4 APU Bottle Discharge Light (amber)

Illuminated – APU fire extinguisher bottle discharged

**5 APU Fire Warning Horn**

Sounds intermittently during ground operation for an APU fire

**Fire/Overheat Test Panel**

**Option - Rolls Royce Engines**

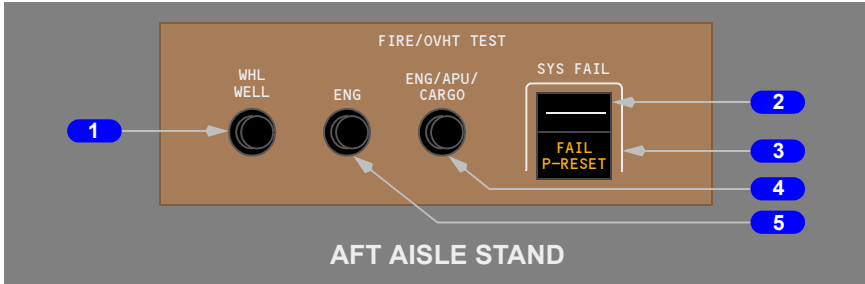

**Option - Pratt and Whitney Engines**

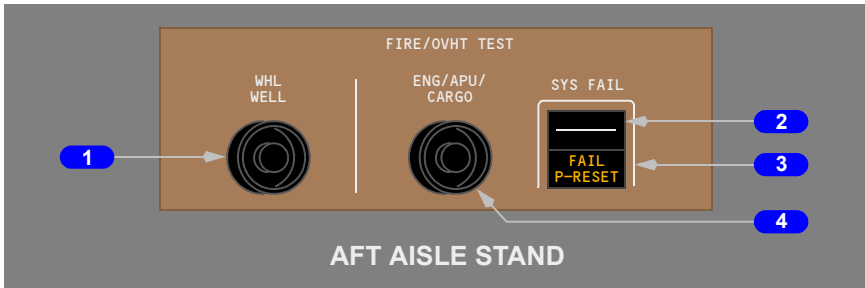

**1 Wheel (WHL) WELL Fire Test Switch**

Push and hold – initiates a wheel well fire test

**2 System Fail (SYS FAIL) Light**

Illuminated (amber) – indicates the failure of the detectors in one of the following systems:

**Option - Pratt and Whitney Engines**

- engine fire
- engine overheat
- APU fire
- cargo fire

**Option - Rolls Royce Engines**

- engine nacelle overheat
- turbine overheat
- strut overheat

- 
- APU fire
  - cargo fire

**3 System Fail Reset Switch (FAIL P – RESET)**

Push – extinguishes the FAIL light and resets the monitor for other systems

**4 ENG/APU/CARGO Test Switch**

Push and hold – initiates an engine, APU, and cargo fire/overheat test

**5 Engine (ENG) Fire Test Switch**

**Option - Rolls Royce Engines**

Push and hold – introduces a fire/overheat signal to turbine and strut detectors

Intentionally  
Blank

---

**Introduction**

There are fire detection and extinguishing systems for the:

- engines
- APU
- cargo compartments
- lavatories

The main gear wheel wells have a fire detection system, but no fire extinguishing system. The system will not detect hot brakes alone, without an associated fire.

Overheat detection systems are installed for both engines, struts, and pneumatic ducts in the wing and body areas.

Refer to Chapter 2 (Air Systems) for a description of equipment smoke evacuation, and bleed duct leak and overheat detection.

---

**Engine Fire Protection**

Engine fire protection consists of these systems:

- engine fire and overheat detection
- engine fire warning
- engine overheat caution
- engine fire extinguishing

**Engine Fire and Overheat Detection**

There are detector loops in each engine nacelle to provide both fire and overheat detection. The SYS FAIL light illuminates and the EICAS advisory message FIRE/OVHT SYS displays to indicate failure of the fire/overheat detection system. The SYS FAIL light and advisory message can be reset to allow monitoring of the remaining systems.

**Engine Fire Warning**

The indications of an engine fire warning are:

- the fire bell sounds
- the master WARNING lights illuminate
- the engine fire switch LEFT or RIGHT fire warning light illuminates
- the discrete FIRE warning light illuminates
- the engine FUEL CONTROL switch fire warning light illuminates.
- the EICAS warning message L or R ENGINE FIRE displays
- the engine fire switch unlocks

---

The fire warning lights remain illuminated as long as the fire signal exists. The fire bell may be silenced by any of the following actions.

- extinguishing the fire
- pushing either master warning/caution reset switch
- pulling the appropriate fire switch

## **Engine Overheat Caution**

The indications of an engine overheat caution are:

- the caution beeper sounds
- the master CAUTION lights illuminate
- the L or R ENG OVHT light illuminates
- the EICAS caution message L or R ENG OVHT displays

The overheat lights remain illuminated as long as the overheat condition exists.

## **Engine Fire Extinguishing**

There are two engine fire extinguisher bottles. Either or both bottles can be discharged into either engine.

When the engine fire switch is pulled out, the fuel is shut off to the associated engine, the engine bleed valves are closed, the generator is tripped off, the hydraulic fluid is shut off, and the fire extinguisher is armed. Rotating the fire switch in either direction discharges a single extinguisher bottle into the associated engine. Rotating the engine fire switch in the other direction discharges the remaining extinguisher bottle into the same engine.

If an extinguisher bottle is discharged or has low pressure:

- the ENG BTL 1 or 2 DISCH light illuminates
- the EICAS advisory message ENG BTL 1 or 2 displays

## **Engine/APU Fire and Override Switches**

The engine and APU fire switches are mechanically locked in the down position to avoid inadvertent activation. When a fire is detected, the respective switch is electrically unlocked and may then be pulled out. Manual unlocking of the switch is accomplished by pushing the fire override switch located beneath the fire switch.

---

## **APU Fire Protection**

APU fire protection consists of these systems:

- APU fire detection
- APU fire warning
- APU fire extinguishing



---

## APU Fire Detection

There are fire detector loops in the APU compartment. There is no APU overheat detection. The SYS FAIL light illuminates and the EICAS advisory message FIRE/OVHT SYS displays to indicate failure of the APU fire detection system. The SYS FAIL light and advisory message can be reset to allow monitoring of the remaining systems.

## APU Fire Warning

The indications of an APU fire warning are:

- the fire bell sounds
- the master WARNING lights illuminate
- the APU fire warning light illuminates
- the discrete FIRE warning light illuminates
- the EICAS warning message APU FIRE displays
- the APU automatically shuts down
- the APU fire switch unlocks

In addition to the above APU fire warnings, if the airplane is on the ground the horn on the nose gear strut sounds and the fire warning light on the APU ground control panel illuminates.

The fire warning lights remain illuminated as long as the fire signal exists. The fire bell (and horn if APU fire on the ground) may be silenced by any of the following actions:

- extinguishing the fire
- pushing either master warning/caution reset switch
- pulling the APU fire switch
- pushing the APU ground shutdown switch if on the ground

## APU Fire Extinguishing

There is one APU fire extinguisher bottle. When the fire switch is pulled out, the fuel is shut off to the APU, the air supply valve is closed, the APU generator is tripped off, and the fire extinguisher is armed. Rotating the switch in either direction discharges the extinguisher bottle into the APU compartment. When the bottle is discharged or has low pressure:

- the APU BTL DISCH light illuminates
- the EICAS advisory message APU BTL displays

An APU fire on the ground with both engines shut down is automatically extinguished. The fire signal causes discharge of the APU extinguisher system a few seconds after automatic shutdown.

---

---

## Main Gear Wheel Well Fire Protection

The main gear wheel well has fire detection and warning only. There is no fire extinguishing system. The nose gear wheel well does not have a fire detection system.

### Main Gear Wheel Well Fire Detection

The main wheel well fire detection system consists of a single fire detection loop.

### Main Gear Wheel Well Fire Warning

The indications for a main wheel well fire are:

- the fire bell sounds
- the master WARNING lights illuminate
- the WHL WELL FIRE warning light illuminates
- the discrete FIRE warning light illuminates
- the EICAS warning message WHEEL WELL FIRE displays

The fire warning lights remain illuminated as long as the fire signal exists. The fire bell may be silenced by any of the following actions:

- extinguishing the fire
- pushing either master warning/caution reset switch

---

---

## Cargo Compartment Fire Protection

Cargo compartment fire protection consists of these systems:

- cargo compartment smoke detection
- cargo compartment fire warning
- cargo compartment fire extinguishing

### Cargo Compartment Smoke Detection

The forward and aft cargo compartments each have smoke detectors installed.

The SYS FAIL light illuminates and the EICAS advisory message FIRE/OVHT SYS displays to indicate failure of the cargo compartment smoke detection system. The SYS FAIL light can be reset to allow monitoring of the remaining systems.

### Cargo Compartment Fire Warning

The indications of a cargo compartment fire are:

- the fire bell sounds
- the master WARNING lights illuminate
- the FWD or AFT cargo fire warning light illuminates

- 
- the discrete FIRE warning light illuminates
  - the EICAS warning message FWD or AFT CARGO FIRE displays

The fire warning lights remain illuminated as long as the fire signal exists. The fire bell may be silenced by any of the following actions:

- extinguishing the fire and clearing the smoke
- pushing either master warning/caution reset switch
- pushing the illuminated cargo compartment ARMED switch

## **Cargo Compartment Fire Extinguishing**

Fire extinguisher bottles are installed for cargo compartment fire extinguishing. Pushing the FWD or AFT cargo compartment ARMED switch arms the extinguishers for that compartment.

Pushing the number 1 cargo fire bottle discharge switch discharges the number 1 fire bottle into the armed compartment. The number 1 cargo fire bottle DISCH light illuminates and the EICAS advisory message CARGO BTL 1 displays to indicate low extinguisher bottle pressure. The number 2 fire extinguisher is manually discharged later in flight to maintain the required concentration of extinguishing agent in the affected compartment. The DISCH light and the EICAS advisory message CARGO BTL 2 displays to indicate low extinguisher bottle pressure.

---

## **Lavatory Fire Protection**

Lavatory fire protection consists of these systems:

- lavatory fire detection and annunciation
- lavatory waste container fire extinguishing

## **Lavatory Fire Detection and Annunciation**

Each lavatory has a single smoke detector. When smoke is detected, aural annunciations sound in the lavatory and in the cabin. Depending on configuration, cabin lavatory smoke detection annunciation will consist of a horn, a chime, a flashing lavatory call light or illumination of the master call light at the associated flight attendant station.

There are no cockpit annunciations of smoke detected in any lavatory.

---

## **Lavatory Fire Extinguishing**

Each lavatory has a fire extinguisher located in the waste container cabinet. Fire extinguisher operation is automatic.

There are no cockpit annunciations of lavatory fire extinguisher operation.

## **Fire and Overheat Detection System Fault Test**

Automatic testing of the engine fire and overheat detectors, APU fire detectors and cargo compartment smoke detectors occurs when electrical power is initially applied. The FIRE/OVHT test panel permits manual testing of the various fire and overheat sensors.

# DO NOT USE FOR FLIGHT

## 757 Flight Crew Operations Manual

### Fire Protection

### System EICAS Messages

### Chapter 8

### Section 30

#### Fire Protection EICAS Messages

Message	Level	Light	Aural	Condition
APU BTL	Advisory	APU BTL DISCH		APU fire extinguisher bottle pressure is low
APU FIRE	Warning	APU	Fire Bell	Fire is detected in the APU
CARGO BTL 1 CARGO BTL 2	Advisory	DISCH		Cargo fire extinguisher bottle 1 or bottle 2 pressure is low
AFT CARGO FIRE FWD CARGO FIRE	Warning	AFT FWD	Fire Bell	Smoke is detected in the affected cargo compartment
ENG BTL 1 ENG BTL 2	Advisory	ENG BTL 1 DISCH ENG BTL 2 DISCH		Engine fire extinguisher bottle 1 or bottle 2 pressure is low
L ENGINE FIRE R ENGINE FIRE	Warning	LEFT RIGHT	Fire Bell	Fire is detected in the engine
L ENG OVHT R ENG OVHT	Caution	L ENG OVHT R ENG OVHT	Beeper	An overheat is detected in the engine
FIRE/OVHT SYS	Advisory	FAIL P-RESET		Fire or overheat detection is inoperative for loops as shown on the status page
WHEEL WELL FIRE	Warning	WHL WELL FIRE	Fire Bell	Fire is detected in a main wheel well

Intentionally  
Blank

<b>Controls and Indicators</b> .....	<b>9.10</b>
Pitch and Stabilizer Trim Systems .....	9.10.1
Control Wheel and Column .....	9.10.1
Stabilizer Trim System .....	9.10.2
Stabilizer Trim Lights .....	9.10.3
Aileron and Rudder Trim Controls .....	9.10.3
Aileron Trim Indicator .....	9.10.3
Aileron and Rudder Trim .....	9.10.4
Rudder System .....	9.10.4
Rudder/Brake Pedals .....	9.10.4
EICAS Status Display .....	9.10.5
Yaw Damper Switches .....	9.10.5
Rudder System Light .....	9.10.6
Flight Control Shutoff Switches .....	9.10.6
Speedbrakes .....	9.10.7
Speedbrake Lever .....	9.10.7
Speedbrake Lights .....	9.10.7
Flap System .....	9.10.8
Flap Controls .....	9.10.8
Flap Position Indicator/Alternate Flaps Selector .....	9.10.10
<b>System Description</b> .....	<b>9.20</b>
Introduction .....	9.20.1
Pilot Controls .....	9.20.1
Flight Control Surfaces .....	9.20.2
Flight Control Surface Locations .....	9.20.2
Pitch Control .....	9.20.2
Elevator .....	9.20.2
Actuator Control Hydraulic Power Distribution .....	9.20.4
Stabilizer Trim Control .....	9.20.5
Electric Trim .....	9.20.5

---

Alternate Trim . . . . .	9.20.5
Automatic Trim . . . . .	9.20.5
Non-normal Operation . . . . .	9.20.5
Roll Control . . . . .	9.20.6
Ailerons . . . . .	9.20.6
Yaw Control . . . . .	9.20.7
Rudder . . . . .	9.20.7
Rudder Ratio . . . . .	9.20.7
Yaw Damping . . . . .	9.20.7
Spoilers . . . . .	9.20.7
Spoiler Speedbrake Operation . . . . .	9.20.8
Flaps and Slats . . . . .	9.20.8
Flap and Slat Sequencing . . . . .	9.20.9
Flap Load Relief . . . . .	9.20.9
Autoslats . . . . .	9.20.9
Flap/Slat Non-Normal Operation . . . . .	9.20.10
Alternate Flap Operation . . . . .	9.20.10
Leading Edge Disagreement . . . . .	9.20.10
Leading Edge Asymmetry . . . . .	9.20.10
Trailing Edge Disagreement . . . . .	9.20.10
Trailing Edge Asymmetry . . . . .	9.20.11
Load Relief Inoperative . . . . .	9.20.11
Hydraulic Driven Generator . . . . .	9.20.11
<b>EICAS Messages . . . . .</b>	<b>9.30</b>
Flight Controls EICAS Messages . . . . .	9.30.1

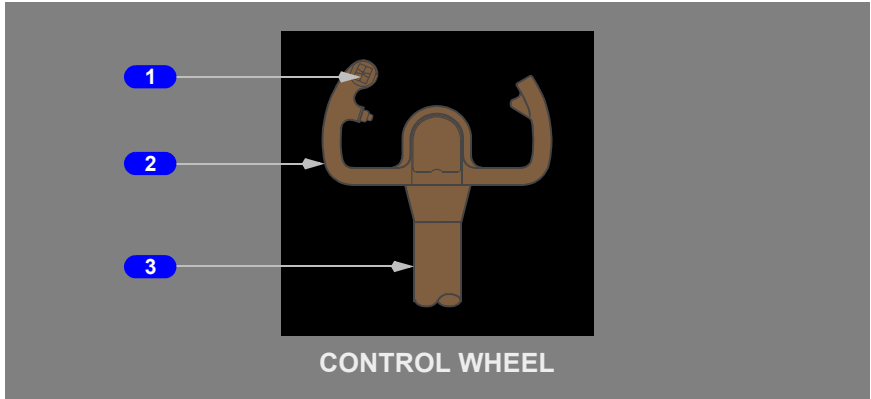

**Pitch and Stabilizer Trim Systems****Control Wheel and Column****1 Pitch Trim Switches**

Spring-loaded to neutral.

Push (both switches) – electrically signals stabilizer movement.

**2 Control Wheel**

Rotate – deflects the ailerons and spoilers in the desired direction.

Moves and remains displaced with aileron trim.

**3 Control Column**

Push/Pull –

- deflects the elevator
- movement opposing stabilizer trim stops trimming

## Stabilizer Trim System

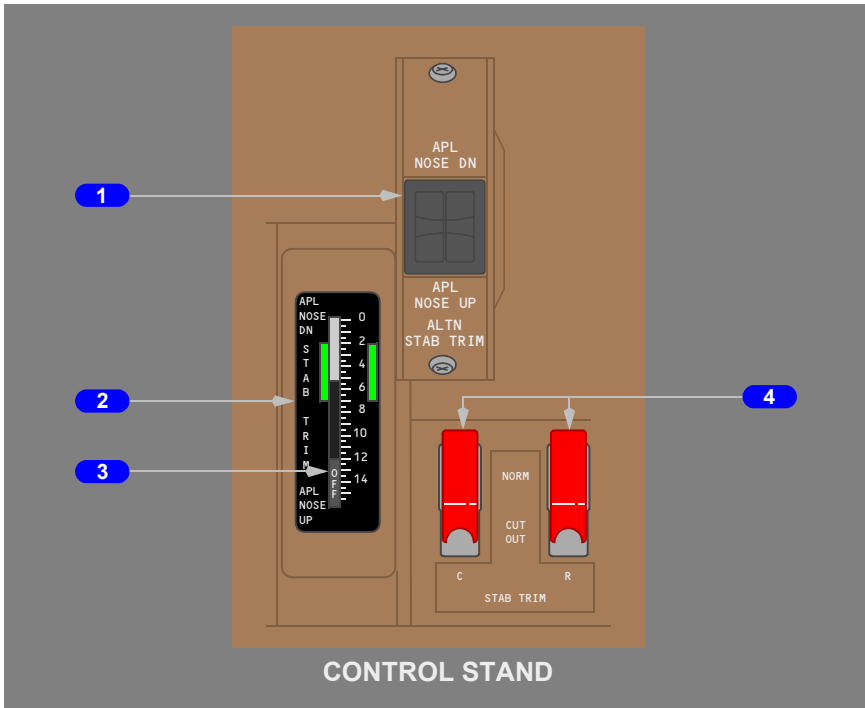

### 1 Alternate Stabilizer Trim (ALTN STAB TRIM) Switches

Spring-loaded to neutral.

Push (both switches) –

- electrically signals stabilizer movement
- neutralizes conflicting trim commands

### 2 Stabilizer Trim (STAB TRIM) Indicator

- indicates stabilizer position in units of trim
- the green bands indicate the allowable takeoff trim range

### 3 Stabilizer Trim OFF Flag

Trim indicator inoperative.

### 4 Stabilizer Trim (STAB TRIM) Cut Out Switches

NORM – hydraulic power is supplied to the related stabilizer trim control module.

CUT OUT – shuts off the respective center or right hydraulic system power to the related stabilizer trim control module.

## Stabilizer Trim Lights

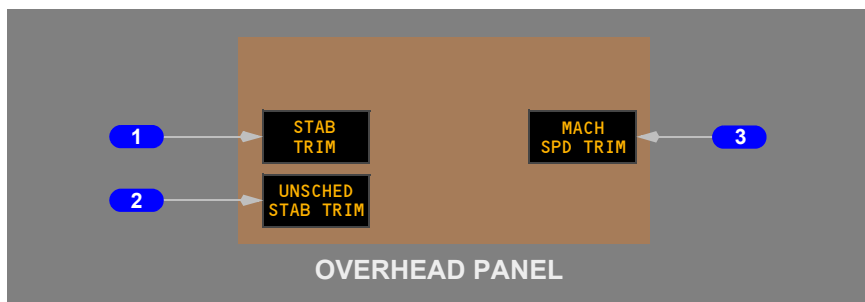

### 1 Stabilizer Trim (STAB TRIM) Light

Illuminated (amber) – stabilizer trim rate is one-half the normal control wheel stabilizer trim switch rate.

### 2 Unscheduled Stabilizer Trim (UNSCHED STAB TRIM) Light

Illuminated (amber) – uncommanded stabilizer motion detected.

### 3 Mach Speed Trim (MACH SPD TRIM) Light

Illuminated (amber) – the mach/speed trim system is inoperative.

## Aileron and Rudder Trim Controls

### Aileron Trim Indicator

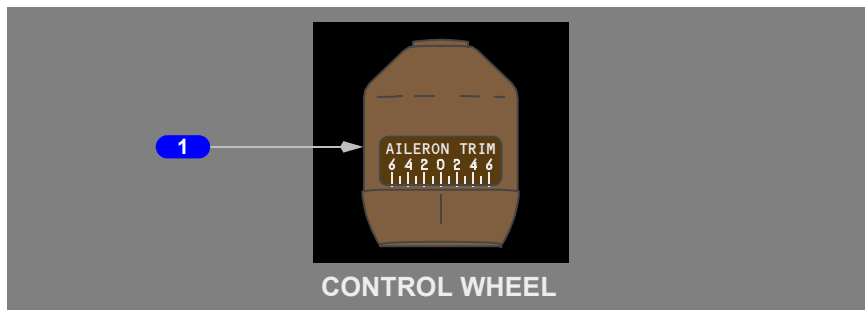

### 1 AILERON TRIM Indicator

Indicates units of aileron trim.

## Aileron and Rudder Trim

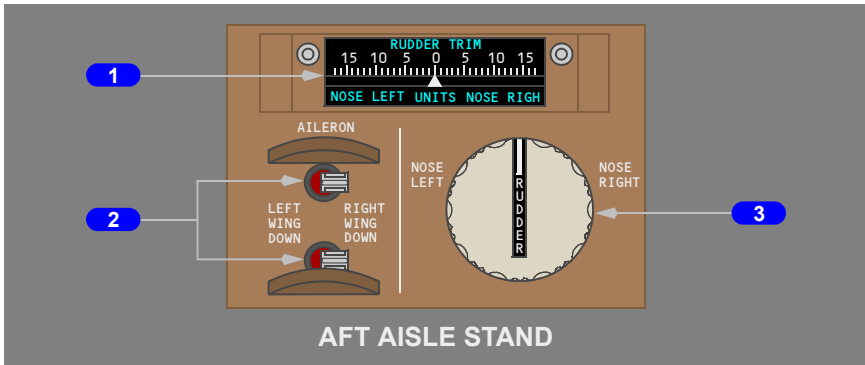

### 1 RUDDER TRIM Indicator

Indicates units of rudder trim.

### 2 AILERON Trim Switches

Spring-loaded to neutral.

Push (both switches) – moves the control wheel, ailerons, and spoilers in the desired direction.

### 3 RUDDER Trim Control

Spring-loaded to neutral.

Rotate – moves the rudder pedals and rudder in the desired direction.

## Rudder System

### Rudder/Brake Pedals

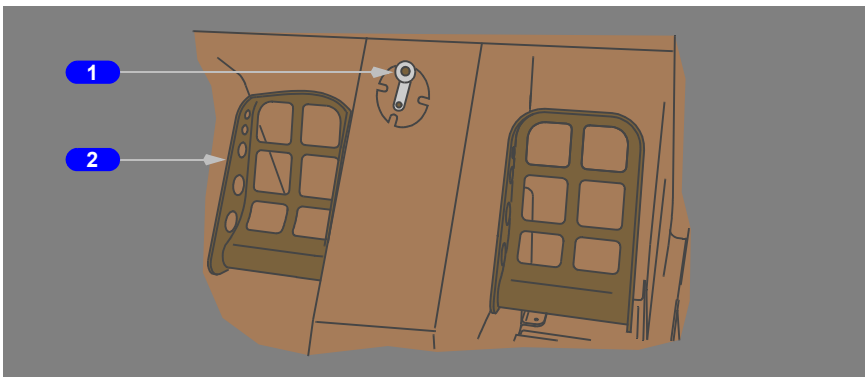

### 1 Rudder Pedals Adjustment Crank

Pull and Rotate – adjusts rudder pedals forward or aft.

### 2 Rudder Pedals

Push – deflects the rudder in the desired direction.

Refer to Chapter 14, Landing Gear, for brakes and nosewheel steering description.

## EICAS Status Display

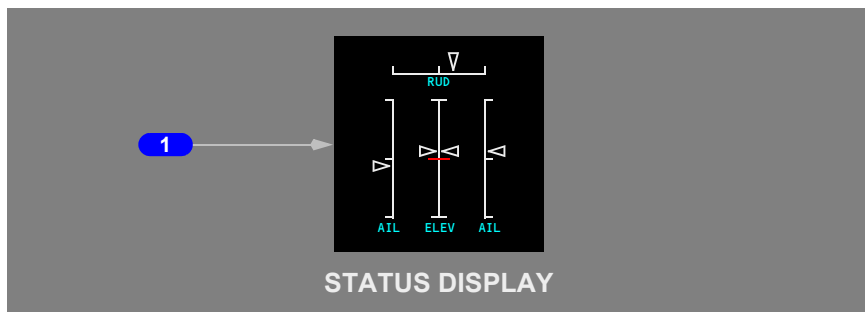

### 1 Rudder, Aileron, and Elevator (RUD, AIL, ELEV) Position

Indicates rudder, aileron, and elevator flight control surface deflection.

## Yaw Damper Switches

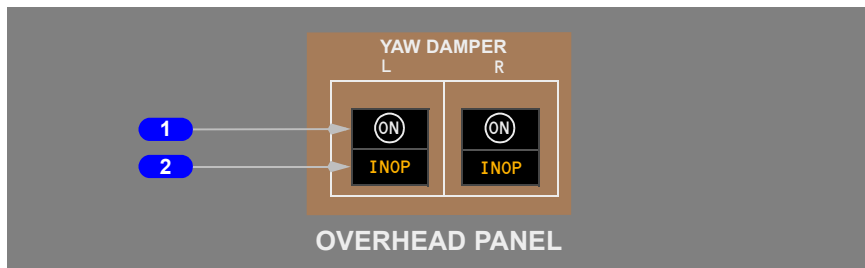

### 1 YAW DAMPER Switches

ON – the yaw damper is commanded on.

Off (ON not visible) – the yaw damper is commanded off.

### 2 Yaw Damper Inoperative (INOP) Lights

Illuminated (amber) – the yaw damper is inoperative.

## Rudder System Light

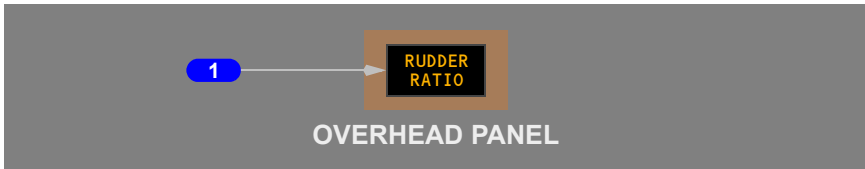

### 1 RUDDER RATIO Light

Illuminated (amber) – the rudder ratio system is failed.

## Flight Control Shutoff Switches

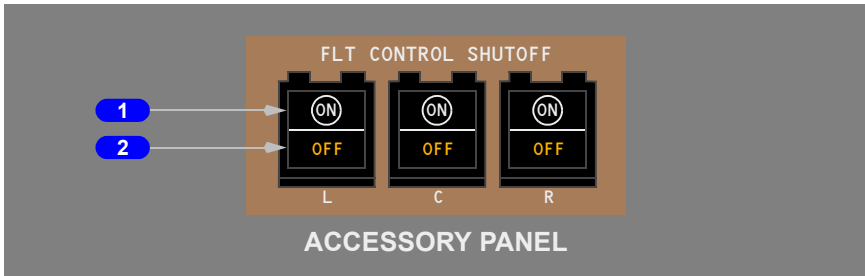

### 1 Flight (FLT) CONTROL SHUTOFF Switches

ON – the flight control valve is commanded open.

Off (ON not visible) – the flight control valve is commanded closed.

### 2 Flight Control Shutoff OFF Lights

Illuminated (amber) – the flight control valve is closed.

## Speedbrakes

### Speedbrake Lever

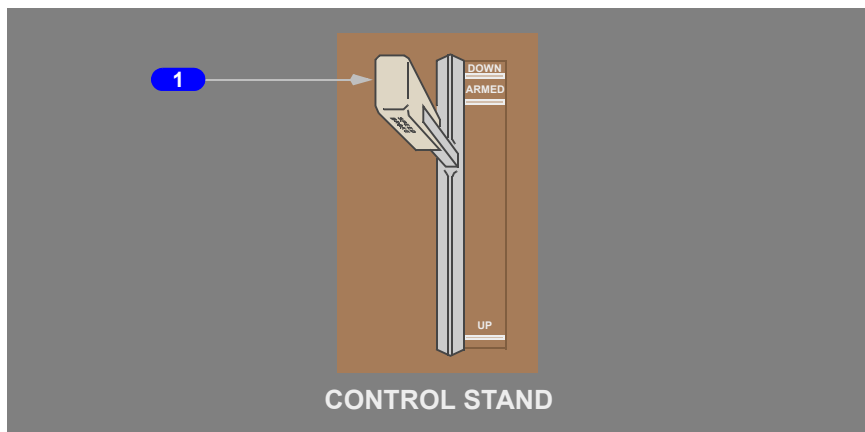

#### 1 Speedbrake Lever

DOWN (detent) – all spoiler panels are retracted.

ARMED –

- the auto speedbrake system is armed
- after landing, the speedbrake lever automatically moves to UP and the spoiler panels extend

UP – the required spoiler panels extend to their maximum in-flight or on-ground position (intermediate positions can be selected).

On the ground:

- the speedbrake lever moves to DOWN and all spoiler panels retract if either thrust lever is advanced to the takeoff thrust position
- the speedbrake lever moves to UP and all spoiler panels extend if either reverse thrust lever is raised to the reverse idle detent

### Speedbrake Lights

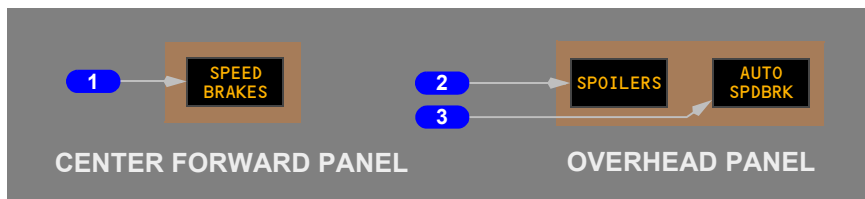

**1 SPEED BRAKES Light**

Illuminated (amber) – the speedbrakes are extended when:

- the flaps are in a landing position, or
- radio altitude is 800 feet or below

**2 SPOILERS Light**

Illuminated (amber) – one or more spoiler pairs are inoperative.

**3 Auto Speedbrake (AUTO SPDBRK) Light**

Illuminated (amber) – a fault is detected in the automatic speedbrake system.

**Note:** Light may illuminate momentarily when the Speedbrake handle is moved to the DOWN position after automatic deployment.

---

## Flap System

### Flap Controls

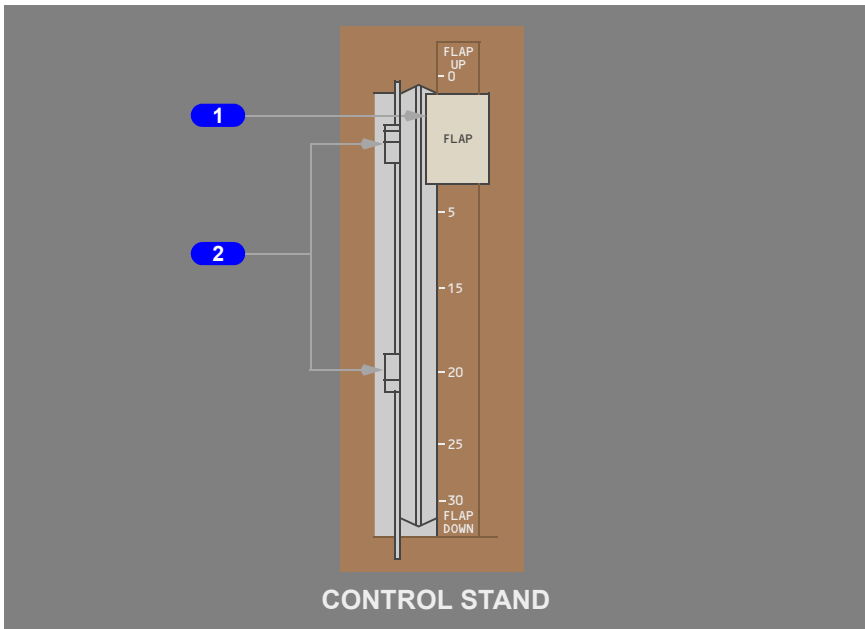

**1 Flap Lever**

Positions the slats and flaps hydraulically.

UP – the slats and flaps are retracted.



---

1 –

- the slats extend to the midrange position
- the flaps extend to 1

5, 15, and 20 –

- the slats remain in the midrange position
- the flaps extend to the commanded position

25 –

- the slats extend to the fully extended position
- the flaps extend to 25

30 –

- the slats remain in the fully extended position
- the flaps extend to 30
- the flap load relief system arms

## **2 Flap Gates**

1 – prevents inadvertent retraction of the slats.

20 – prevents inadvertent retraction of the flaps past the go-around position.

## Flap Position Indicator/Alternate Flaps Selector

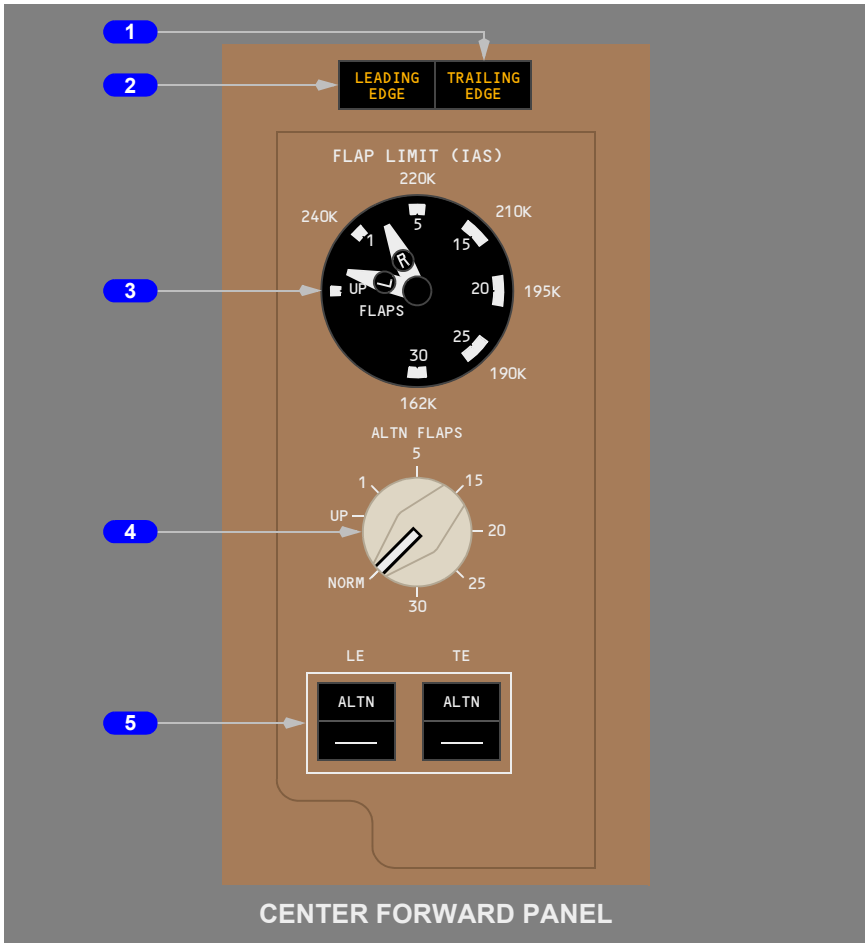

### 1 TRAILING EDGE Light

Illuminated (amber) –

- a flap disagree exists
- a flap asymmetry exists
- the flap load relief system is not operating when required

### 2 LEADING EDGE Light

Illuminated (amber) –

- a slat disagree exists
- a slat asymmetry exists

---

### **3 Flap Position Indicator**

Indicates flap position.

UP – the slats and flaps are retracted.

Between UP and 1 –

- the slats are between the retracted and midrange position
- the flaps are between the retracted and 1 position

1 to 30 – the flaps are in the indicated position.

### **4 Alternate (ALTN FLAPS) Flaps Selector**

NORM – normal flap operation, alternate system not in use.

UP – the slats and flaps are retracted.

1 –

- the slats extend to the midrange position
- the flaps extend to 1

5 and 15 –

- the slats remain in the midrange position
- the flaps extend to the commanded position

20 –

- the slats extend to the fully extended position
- the flaps extend to 20

Alternate flaps switches must be in ALTN for the slats and flaps to move.

### **5 Alternate (ALTN) Flaps Switches**

ALTN –

- arms the selected LE slat or TE flap alternate drive unit
- shuts off hydraulic power to both the flap and slat drive systems

Off (ALTN not visible) – alternate flaps and slats command inactive.

Intentionally  
Blank

---

**Introduction**

The primary flight controls are elevators, ailerons, and rudders. The control column, control wheel, and rudder pedals control these flight control surfaces. The primary flight controls are powered by redundant hydraulic systems; there is no manual reversion.

Secondary flight controls include a moveable horizontal stabilizer, spoilers, and leading and trailing edge flaps. Spoilers operate differentially to assist ailerons for roll control and symmetrically as speedbrakes.

There are three guarded flight control shutoff switches that control hydraulic power to the stabilizer, elevators and rudder. The flight control shutoff OFF light illuminates and the EICAS advisory message L, C, or R FLT CONT HYD displays when a flight control valve is closed. If two or more OFF lights illuminate the EICAS advisory message FLT CONT VALS displays.

---

**Pilot Controls**

The pilot controls consist of:

- two control columns
- two control wheels
- two pairs of rudder pedals
- control wheel stabilizer trim switches
- the speedbrake lever
- the flap lever
- aileron trim switches
- rudder trim switch
- alternate stabilizer trim switches

The columns and wheels are connected through jam override mechanisms. If a jam occurs in a column or wheel, the pilots can maintain control by applying force to the other column or wheel to overcome the jam. When a restricted portion of the flight controls are bypassed, some control effectiveness may be lost.

The rudder pedals are rigidly connected between the two sides.

The speedbrake lever allows manual or automatic symmetric actuation of the spoilers.

---

---

## Flight Control Surfaces

Pitch control is provided by:

- two elevators
- a movable horizontal stabilizer

Roll control is provided by:

- two ailerons
- ten spoilers

Yaw control is provided by a single rudder.

Flaps and slats provide high lift for takeoff, approach, and landing.

Symmetric spoilers are used as speedbrakes.

## Flight Control Surface Locations

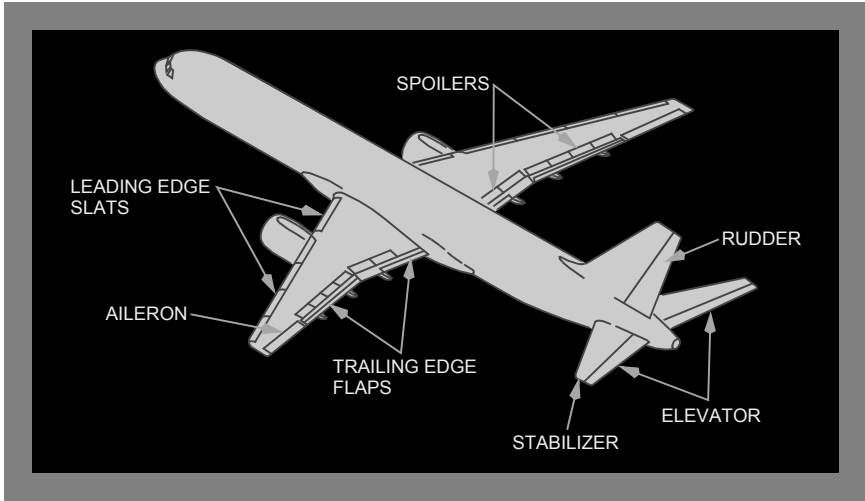

---

---

## Pitch Control

The pitch control surfaces consist of two elevators and a stabilizer. A Mach speed trim system operates the stabilizer to improve speed stability.

## Elevator

Moving the control column signals hydraulic actuators to move the elevators.

Elevator positions are shown on the EICAS status display. Separate pointers indicate the left and right elevator deflection. A full-scale indication corresponds to the maximum elevator deflection.

If one control column should jam, applying significant forward or aft force to the other causes the two columns to override. Pitch control is then available using the free control column path.

Two elevator feel systems provide artificial feel forces to the pilots control columns. Mechanical springs provide feel following a loss of the center and right hydraulic systems.

## Actuator Control Hydraulic Power Distribution

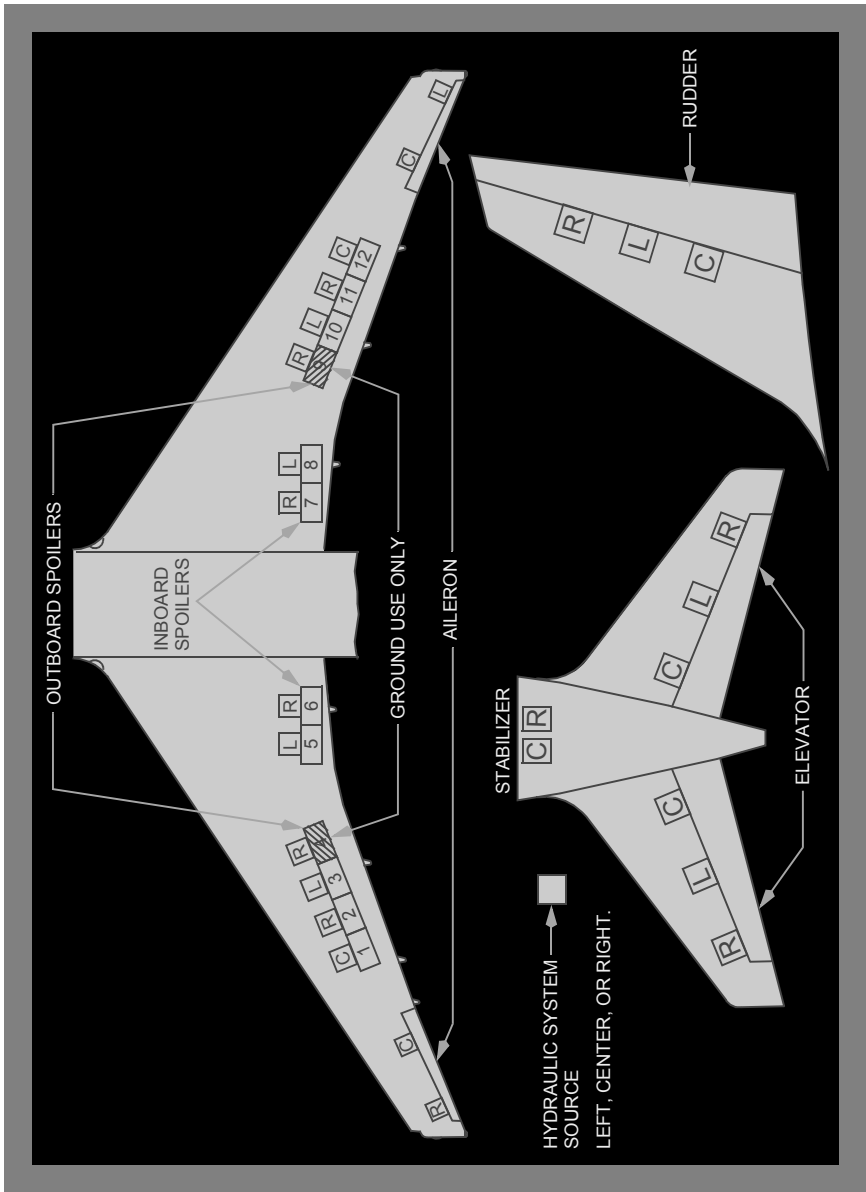



---

## Stabilizer Trim Control

The stabilizer is powered by the center and right hydraulic systems. Stabilizer position commands are sent to the stabilizer trim control modules, which control hydraulic power to the stabilizer. There are two modules, one for each stabilizer hydraulic source.

Stabilizer position is displayed on two stabilizer position indicators located on the control stand. Green bands indicate the normal trim settings for takeoff.

There are three modes of stabilizer trim control:

- electric
- alternate
- automatic

### Electric Trim

Dual electric pitch trim switches located on the control wheel must be pushed simultaneously to command trim changes. To set Stabilizer Trim less than 3 units, requires use of Alternate Trim system.

### Alternate Trim

Alternate trim control is provided by the alternate stabilizer trim switches on the control stand. Pushing both switches simultaneously commands trim changes and provides an increased range of stabilizer travel. The signals neutralize any other conflicting trim inputs.

### Automatic Trim

The stabilizer is controlled automatically by the autopilot or by a Mach speed trim system when the autopilots are not engaged. The Mach speed trim system improves speed stability by trimming the stabilizer as airspeed changes. Electric, backup, or autopilot trimming inhibits the Mach speed trim system.

Automatic stabilizer trim uses only one trim control module and trims at one-half the electric or alternate trim rate.

### Non-normal Operation

If a single autopilot is engaged, electric trimming causes the autopilot to disengage. If multiple autopilots are engaged, the electric trim switches are inhibited. Alternate trimming does not cause autopilot disengagement.

The UNSCHED STAB TRIM light illuminates and the EICAS caution message UNSCHD STAB TRIM displays when uncommanded stabilizer motion is detected.

The light and message also occur if alternate trim is used with an autopilot engaged.

---

The center and right stabilizer cutout switches control hydraulic power to the respective stabilizer trim control module. Placing both switches in the CUT OUT position removes all hydraulic power from the stabilizer.

The control column can be used to interrupt stabilizer trim commands. This feature allows the pilot to quickly stop uncommanded trim changes. The stabilizer trim commands are interrupted if the control column is displaced in the opposing direction.

The STAB TRIM light illuminates and the EICAS advisory message STAB TRIM displays when the stabilizer trim rate is one-half of the normal control wheel stabilizer trim switch rate.

If the malfunction is unique to the electric trim control, full trim rate is available by using alternate trim.

The MACH SPD TRIM light illuminates and the EICAS advisory message MACH/SPD TRIM displays when the Mach speed trim system is inoperative.

---

## Roll Control

An aileron is located on each wing on either side of the outboard trailing edge flap. Aileron surface deflections are proportional to control wheel displacement. Spoilers begin to extend to augment roll control after several degrees of control wheel rotation. Control wheel forces increase as control displacement increases.

The control wheels are connected so that, if one control wheel jams, using significant force causes the control wheels to override. Roll control is then available using the free control wheel.

### Ailerons

Aileron positions are shown on the EICAS status display. A full-scale indication corresponds to maximum aileron deflection.

Dual aileron trim switches located on the aft aisle stand must be pushed simultaneously to command trim changes. Hydraulic power from one of the three hydraulic systems is necessary to accurately set aileron trim.

The amount of aileron trim is indicated on a scale on the top of each control column.

**Note:** If the flight crew inadvertently activates aileron trim while an autopilot is engaged, the repositioning of the aileron neutral point is not apparent to the crew. When the autopilot is disengaged, the control wheels and ailerons move to the new (possibly undesired) neutral point and the airplane will roll proportional to the amount of trim input.

---

---

## Yaw Control

Yaw control is provided by a single rudder. Two yaw dampers operate through the rudder control system to improve directional stability.

## Rudder

Rudder position is shown on the EICAS status display. On the ground, a full scale indication corresponds to the maximum rudder deflection.

The rudder trim control can be used to command trim changes. The rudder trim indicator shows the units of rudder trim that are commanded.

## Rudder Ratio

The control commands from the rudder pedals and trim control are modified by a rudder ratio changer. As airspeed increases the ratio changer desensitizes these commands from the pilot to reduce the rudder deflection.

The ratio changer receives air data computer airspeed inputs and provides control commands to an actuator powered by the left hydraulic system. The actuator then dampens the pilots inputs to the rudder.

The RUDDER RATIO light illuminates and the EICAS advisory message RUDDER RATIO displays to indicate the rudder ratio system is failed. Rudder structural protection is provided by automatic depressurization of the left hydraulic system actuator which limits rudder displacement at high airspeeds. However, abrupt rudder pedal input should be avoided at high airspeeds. At low airspeeds the two remaining rudder actuators provide sufficient control for full rudder displacement.

If the left hydraulic system is providing normal pressure to the ratio changer, a fault may result in limited displacement of the rudder at all airspeeds. This requires that crosswind and auto land limitations be observed.

## Yaw Damping

The yaw damper systems improve turn coordination and dutchroll damping.

The yaw damper INOP light illuminates and the EICAS advisory message L or R YAW DAMPER displays, when a yaw damper is inoperative.

---

---

## Spoilers

There are six spoiler panels located on the upper wing surface of each wing. Spoilers on opposing wings are symmetrically paired.

Spoiler panels are used as speedbrakes to increase drag and reduce lift, both in flight and on the ground. The spoilers also supplement roll control in response to control wheel commands.

## Spoiler Speedbrake Operation

The speedbrakes are controlled by the speedbrake lever located on the control stand. The speedbrake lever has three marked positions:

- DOWN
- ARMED
- UP

The speedbrake lever can be placed in intermediate positions between ARMED and UP.

In the ARMED position, when the landing gear is fully on the ground (not tilted) and the thrust levers are at idle, the speedbrake lever is driven aft to the UP position and the spoiler panels are fully extended.

On the ground when either reverse thrust lever is moved to the reverse idle detent, the speedbrake lever is driven aft to the UP position and the spoiler panels are fully extended. The speedbrake lever does not need to be in the ARMED position.

The EICAS caution message SPEEDBRAKES EXT displays and the SPEEDBRAKES light illuminates if speedbrakes are extended when:

- the flaps are in a landing position
- radio altitude is 800 feet or below

The AUTO SPDBRK light illuminates and the EICAS advisory message AUTO SPEEDBRAKE displays to indicate a fault is detected in the automatic speedbrake system which may result in the loss of automatic speedbrake extension. If the speedbrake lever is armed, the message and light indicate a fault which may result in an inadvertent speedbrake extension in flight. The speedbrake lever should be returned to the DOWN position. The speedbrakes can still be operated manually. The AUTO SPDBRK light may illuminate and the EICAS advisory message AUTO SPEEDBRAKE may display momentarily when the speedbrake lever is moved to the DOWN position after the speedbrakes have been deployed automatically. Both the light and the message will extinguish when the panels are retracted.

The SPOILERS light illuminates and the EICAS advisory message SPOILERS displays to indicate that one or more spoiler pairs are inoperative.

---

## Flaps and Slats

The trailing edge flaps and leading edge slats are high lift devices that increase wing lift and decrease stall speed during takeoff, approach, and landing.

Flap and slat positions are indicated by two pointers in the flap position indicator. There are L and R pointers for the left and right wing flaps and slats. The right pointer is normally hidden from view by the left pointer.

---

In the flaps 1 position, the flaps and slats move. Flaps 1, 5, 15, 20 are takeoff flap positions.

Flaps 25 and 30 are landing flaps positions. Flaps 20 is used for some non-normal landing conditions.

## **Flap and Slat Sequencing**

When the flap lever is in the UP detent, all flaps and slats are commanded retracted and the flap position indicator points to UP. Moving the flap lever aft allows selection of flap detent positions 1, 5, 15, 20, 25, and 30.

Starting from flaps UP, selection of flaps 1 commands the slats to move to the midrange position. The flaps extend to 1. The position indicator pointers move mid-way between UP and 1 when the flaps and slats are in transit. The pointers move to the 1 indication when all slats are in the midrange position and flaps reach position 1.

Selection of the flaps 5, 15, or 20 positions commands the flaps to move to the position selected. The slats remain in the midrange position. The position indicator provides only trailing edge flap position indications for all flap settings greater than 1.

Selection of flaps 25 commands both the flaps and slats to move to landing positions.

Selection of flaps 30 commands the flaps to extend to the primary landing position.

During retraction flap and slat sequencing is reversed.

The flap gate at the flaps 20 detent prevents inadvertent retraction of the flaps past the go-around position. The flap gate at flaps 1 prevents inadvertent retraction of the slats.

## **Flap Load Relief**

The flap load relief system protects the flaps from excessive airloads. If the flap airspeed placard limit is exceeded with the flaps in the 30 position, the flaps automatically retract to position 25.

When airspeed is reduced, the flaps automatically re-extend.

## **Autoslats**

The autoslat system enhances airplane stall characteristics. Upon receiving a signal from the stall warning system, the slats automatically extend from the midrange position to the fully extended landing position. The slats retract a few seconds after the signal is removed.

---

---

## Flap/Slat Non-Normal Operation

### Alternate Flap Operation

The alternate mode allows direct manual operation of the flaps and slats through electric motors. The alternate flaps switches:

- disable normal control
- arm the alternate mode
- engage the electric motors
- the flap lever no longer controls flaps/slats

The alternate flaps selector extends and retracts the flaps and slats. Alternate mode flap and slat extension is limited to flaps 20. Trailing edge flap asymmetry protection, autoslats, and flap load relief are not available in the alternate mode. Because autoslats are unavailable, the slats are fully extended at flaps 20 to improve stall handling characteristics.

Slat and flap operation time in the alternate mode is greatly increased.

### Leading Edge Disagreement

The LEADING EDGE light illuminates and the EICAS caution message LE SLAT DISAGREE displays when the leading edge slat positions disagree with commanded position. The disagree indicates that the slats are not driving toward their new commanded position. Hydraulic power to both slats and flaps is automatically shut off.

### Leading Edge Asymmetry

The LEADING EDGE light illuminates and the EICAS caution message LE SLAT ASYM displays when the leading edge slats are not symmetrically extended. Hydraulic power to both slats and flaps is automatically shut off.

### Trailing Edge Disagreement

The TRAILING EDGE light illuminates and the EICAS caution message TE FLAP DISAGREE displays when the trailing edge flap positions disagree with commanded position. The disagree indicates that the flaps are not driving toward their new commanded position. Hydraulic power to both slats and flaps is automatically shut off.

A TE FLAP DISAGREE may also occur if the flap lever is not in a detent for an extended period of time. In this case, the light and message can be removed by moving the flap lever to the desired detent.

---

## **Trailing Edge Asymmetry**

The TRAILING EDGE light illuminates and the EICAS caution message TE FLAP ASYM displays when the trailing edge flaps are not symmetrically extended. Hydraulic power to both slats and flaps is automatically shut off.

## **Load Relief Inoperative**

The TRAILING EDGE light illuminates and the EICAS advisory message FLAP LD RELIEF displays when the flap load relief system fails to operate when required.

## **Hydraulic Driven Generator**

When the hydraulic driven generator is supplying electrical power, hydraulic flow to the slats and flaps is reduced, resulting in increased slat and flap operation time.

Intentionally  
Blank



**Flight Controls EICAS Messages**

**Note:** Configuration warning messages are covered in Chapter 15, Warning Systems.

The following EICAS messages can be displayed.

Message	Level	Light	Aural	Condition
AUTO SPEEDBRAKE	Advisory	AUTO SPDBRK		A fault is detected in the automatic speedbrake system.
FLAP LD RELIEF	Advisory	TRAILING EDGE		The flap load relief system fails to operate when required.
C FLT CONT HYD L FLT CONT HYD R FLT CONT HYD	Advisory	OFF		The flight control valve is closed.
FLT CONT VALS	Advisory	OFF		Two or more flight control valves are closed.
LE SLAT ASYM	Caution	LEADING EDGE	Beeper	The leading edge slats are not symmetrically extended.
LE SLAT DISAGREE	Caution	LEADING EDGE	Beeper	The leading edge slat positions disagree with commanded position.
MACH/SPD TRIM	Advisory	MACH SPD TRIM		The Mach speed trim system is inoperative.
RUDDER RATIO	Advisory	RUDDER RATIO		The rudder ratio system is failed.
SPEEDBRAKES EXT	Caution	SPEED BRAKES	Beeper	The speedbrake lever is extended when the flaps are in a landing position, or when radio altitude is 800 feet or below.
SPOILERS	Advisory	SPOILERS		One or more spoiler pairs are inoperative.

**DO NOT USE FOR FLIGHT**  
757 Flight Crew Operations Manual

Message	Level	Light	Aural	Condition
STAB TRIM	Advisory	STAB TRIM		The stabilizer trim rate is one-half of the normal control wheel stabilizer trim switch rate.
TE FLAP ASYM	Caution	TRAILING EDGE	Beeper	The trailing edge flaps are not symmetrically extended.
TE FLAP DISAGREE	Caution	TRAILING EDGE	Beeper	The trailing edge flap positions disagree with commanded position.
UNSCHD STAB TRIM	Caution	UNSCHEM STAB TRIM	Beeper	Uncommanded stabilizer motion is detected.
L YAW DAMPER R YAW DAMPER	Advisory	INOP		The yaw damper is inoperative.

**EFIS Controls and Indicators . . . . . 10.10**

- Attitude Director Indicator (ADI) Display . . . . . 10.10.1
  - ADIs with Flight Mode Annunciations (FMA) on Bottom . . 10.10.1
  - ADIs with Flight Mode Annunciations (FMA) on Top . . . . 10.10.5
  - ADI Speed Tape . . . . . 10.10.10
  - ADI Failure Flags and Annunciations . . . . . 10.10.14
- Horizontal Situation Indicator (HSI) Display Modes . . . . . 10.10.16
  - MAP Mode . . . . . 10.10.16
  - CTR MAP Mode . . . . . 10.10.20
  - APP Mode . . . . . 10.10.24
  - CTR APP Mode . . . . . 10.10.26
  - VOR Mode . . . . . 10.10.28
  - CTR VOR Mode . . . . . 10.10.30
  - PLAN Mode . . . . . 10.10.32
- HSI Symbology . . . . . 10.10.35
  - Heading, Track, and Wind . . . . . 10.10.35
  - Radio Navigation . . . . . 10.10.37
  - Map . . . . . 10.10.40
  - Radar . . . . . 10.10.44
  - TCAS . . . . . 10.10.47
  - Look–Ahead Terrain . . . . . 10.10.49
  - Predictive Windshear . . . . . 10.10.50
  - HSI Failure Flags and Annunciations . . . . . 10.10.51
- Instrument Switching . . . . . 10.10.52
  - Left Instrument Source Selector Panel (Upper) . . . . . 10.10.52
  - Left Instrument Source Selector Panel (Lower) . . . . . 10.10.53
  - Right Instrument Source Selector Panel (Upper) . . . . . 10.10.54
  - Right Instrument Source Selector Panel (Lower) . . . . . 10.10.55
  - EFI/IRS Interface Diagram . . . . . 10.10.57
  - Heading Reference Switch . . . . . 10.10.58
- EFIS Control Panel . . . . . 10.10.59

---

<b>EFIS System Description</b> .....	<b>10.20</b>
Introduction .....	10.20.1
EFIS Symbol Generators .....	10.20.1
EFIS Control Panels .....	10.20.1
Attitude Director Indicator .....	10.20.1
Attitude Display .....	10.20.2
Mode Annunciations .....	10.20.2
Flight Director Commands .....	10.20.2
Glide Slope and Localizer Deviation Displays .....	10.20.2
Attitude Comparator .....	10.20.2
Height Alert .....	10.20.2
Radio Altitude and Decision Height .....	10.20.3
Pitch Limit Indicator .....	10.20.3
Ground Speed Display .....	10.20.3
Airspeed Display .....	10.20.3
Horizontal Situation Indicator (HSI) .....	10.20.4
Display Orientation .....	10.20.4
Track .....	10.20.4
MAP Mode .....	10.20.4
VOR Mode .....	10.20.4
APP Mode .....	10.20.4
PLAN Mode .....	10.20.5
Weather Radar Display .....	10.20.5
Traffic .....	10.20.5
Terrain Display .....	10.20.5
Predictive Windshear .....	10.20.5
EFIS Failures Flags and Annunciations .....	10.20.5
Light Sensing and Brightness Control .....	10.20.6
<b>Conventional Instruments Controls and Indicators</b> .....	<b>10.30</b>
Conventional Flight Instruments .....	10.30.1
Mach/Airspeed Indicator (Electric) .....	10.30.1
Primary Altimeter (Electric) .....	10.30.2
Radio Distance Magnetic Indicator .....	10.30.3

---

Vertical Speed Indicator . . . . .	10.30.5
Clock . . . . .	10.30.5
Standby Flight Instruments . . . . .	10.30.7
Standby Attitude Director Indicator (Standby ADI) . . . . .	10.30.7
Standby Airspeed Indicator (Pneumatic) . . . . .	10.30.9
Standby Altimeter (Pneumatic) . . . . .	10.30.9
Standby Magnetic Compass . . . . .	10.30.10
Flight Recorder . . . . .	10.30.10
<b>Conventional Instruments System Description . . . . .</b>	<b>10.40</b>
Introduction . . . . .	10.40.1
Primary Flight Instruments . . . . .	10.40.1
Mach/Airspeed Indicator . . . . .	10.40.1
Primary Altimeter . . . . .	10.40.1
Radio Distance Magnetic Indicator (RDMI) . . . . .	10.40.1
Vertical Speed Indicator . . . . .	10.40.2
Clock . . . . .	10.40.2
Standby Flight Instruments . . . . .	10.40.2
Standby Attitude Director Indicator (Standby ADI) . . . . .	10.40.2
Standby Airspeed Indicator (Pneumatic) . . . . .	10.40.2
Standby Altimeter (Pneumatic) . . . . .	10.40.2
Standby Magnetic Compass . . . . .	10.40.2
Flight Recorder . . . . .	10.40.3
Air Data System . . . . .	10.40.3
Pitot–Static System Schematic (ADCs) . . . . .	10.40.4
Total Air Temperature (TAT) . . . . .	10.40.4
True Airspeed/Static Air Temperature (TAS/SAT) . . . . .	10.40.5
<b>EICAS Messages . . . . .</b>	<b>10.50</b>
Flight Instruments, Displays EICAS Messages . . . . .	10.50.1

Intentionally  
Blank

#### Attitude Director Indicator (ADI) Display

#### ADIs with Flight Mode Annunciations (FMA) on Bottom

Basic: FMA on bottom

Basic: Fast/slow airspeed indicator

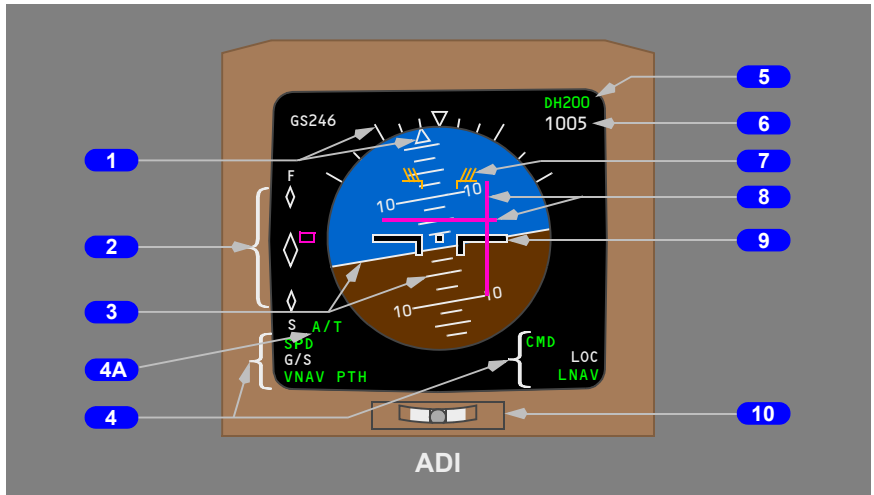

Basic: No height alerting

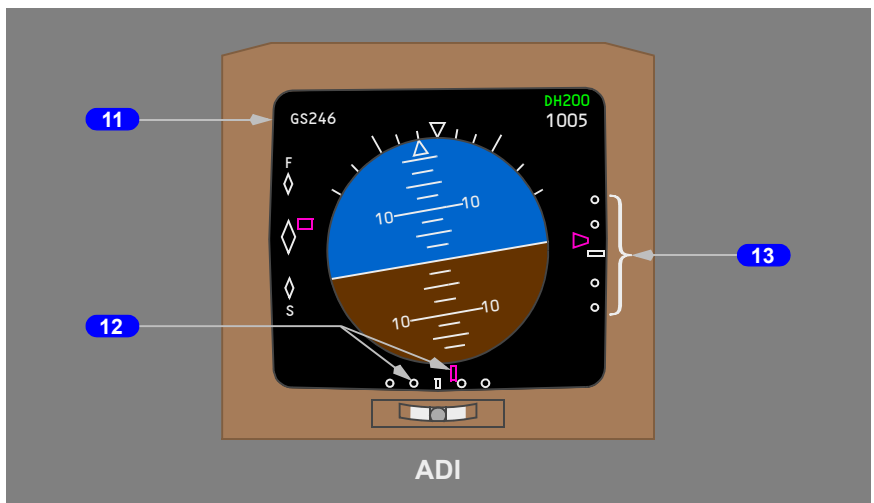





## **5 Decision Height**

Displays selected decision height.

- blanks when negative decision height is selected
- display changes from green to amber, increases in size and “DH” flashes momentarily when airplane descends below decision height (decision height alerting)
- decision height alert is reset automatically – if airplane climbs 75 feet or more above the selected decision height, or after the airplane lands
- decision height alert is reset manually – if the RST switch is pushed.

## **6 Radio Altitude**

Displays radio altitude below 2500 feet AGL.

- blank above 2500 feet AGL
- changes color from white to amber when below selected decision height on descent
- changes color from amber back to white when airplane climbs 75 feet or more above the selected decision height, or after the airplane lands
- changes color from amber back to white when the RST switch is pushed.

## **7 Pitch Limit Indicator**

Indicates pitch limit (stick shaker activation point for the existing flight conditions).

- displays when flaps are extended.

## **8 Flight Director Command Bars**

Indicates flight director pitch and roll steering commands.

- displays when the respective F/D switch is ON, valid command steering is available, and the selected flight director and autopilot in (CMD) are not the same
- blanks when the respective FD switch is OFF, or when command steering becomes invalid, or when the selected flight director and autopilot in (CMD) are the same.

## **9 Airplane Symbol**

Indicates airplane attitude with reference to the IRS horizon.

## **10 Slip Indicator**

Indicates coordinated flight.

### **11 Height Alert**

**Options: Height alerting at 1,000, 1,500, or 2,500 feet.**

Indicates airplane has descended through a specified altitude.

- blanks if the RST switch is pushed.
- displays during descent from 2,500 feet to 500 feet AGL

### **11 Ground Speed**

Indicates ground speed in knots.

### **12 Ground Speed**

Indicates ground speed in knots.

### **12 Localizer Pointer and Deviation Scale**

The localizer pointer indicates position relative to the airplane.

- scale indicates deviation
- pointer not displayed when localizer is unusable
- scale and pointer not displayed when an ILS frequency is not selected
- a two dot expanded localizer scale (not shown here) displays when LOC is engaged and deviation is slightly more than one half dot on the four dot scale. The expanded scale is more sensitive, with one dot deviation equal to one half dot deviation on the four dot scale

### **13 Localizer Pointer and Deviation Scale**

The localizer pointer indicates position relative to the airplane.

- scale indicates deviation
- pointer not displayed when localizer is unusable
- scale and pointer not displayed when an ILS frequency is not selected
- a two dot expanded localizer scale (not shown here) displays when LOC is engaged and deviation is slightly more than one half dot on the four dot scale. The expanded scale is more sensitive, with one dot deviation equal to one half dot deviation on the four dot scale

### **13 Glide Slope Pointer and Deviation Scale**

The glideslope pointer indicates glideslope position relative to the airplane.

- scale indicates deviation
- pointer not displayed when glide slope unusable or when track and the front course on the ILS panel differ by more than 90°
- scale and pointer not displayed when an ILS frequency is not selected

**14** **Glide Slope Pointer and Deviation Scale**

The glideslope pointer indicates glideslope position relative to the airplane.

- scale indicates deviation
- pointer not displayed when glide slope unusable or when track and the front course on the ILS panel differ by more than 90°
- scale and pointer not displayed when an ILS frequency is not selected

**ADIs with Flight Mode Annunciations (FMA) on Top**

**Option: Flight Mode Annunciations on top.**

Option: Speed tape with rolling digits.

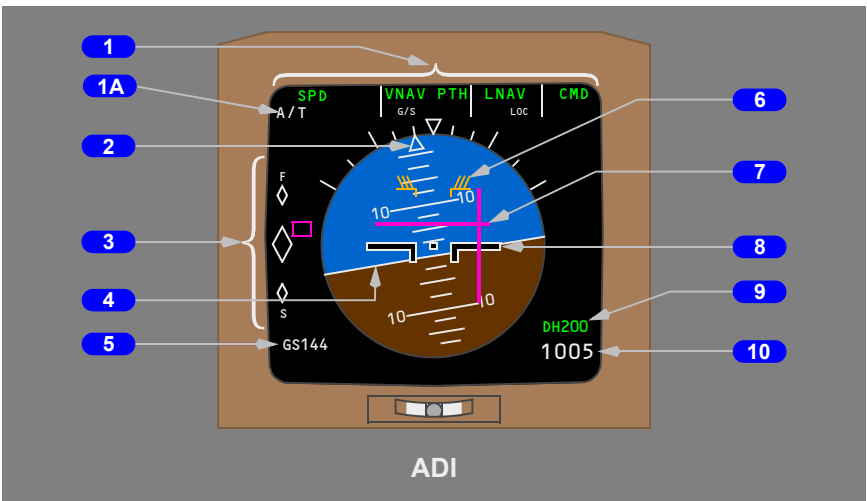
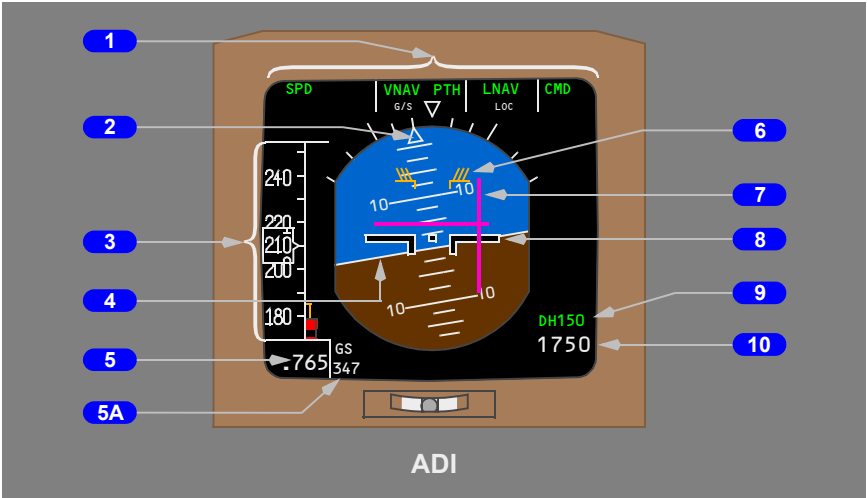

Basic: No height alerting

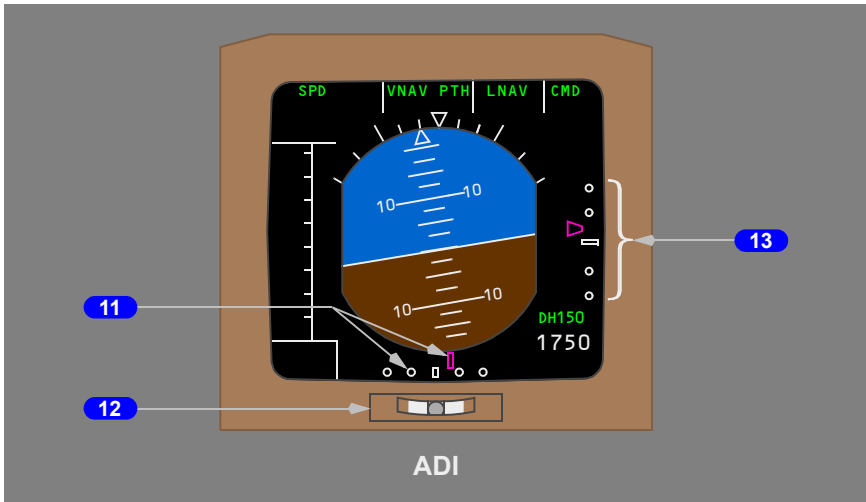

Option: Height alerting

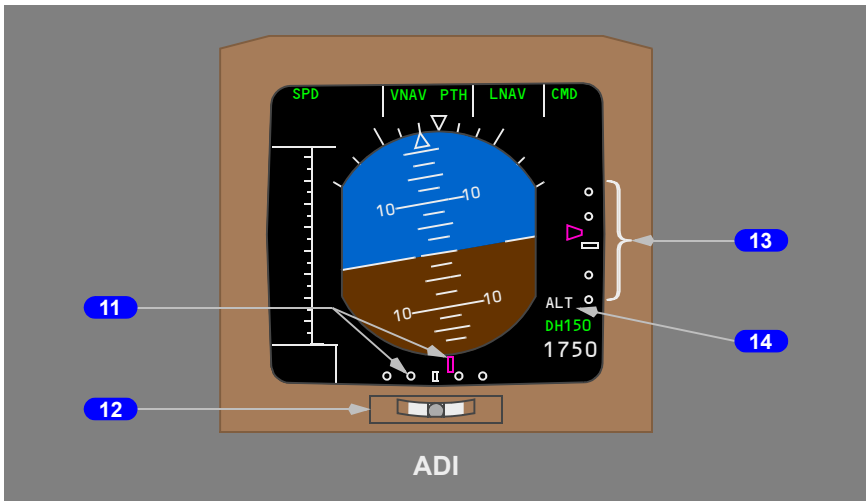

Basic: No height alerting

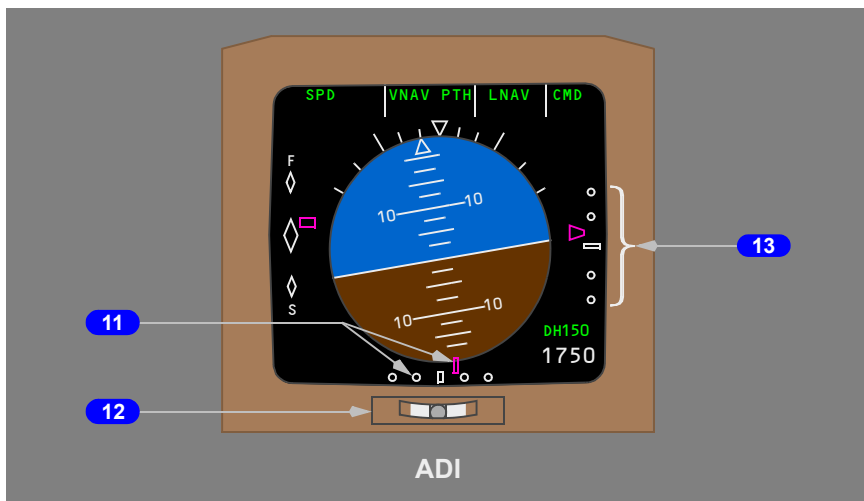

Option: Height alerting

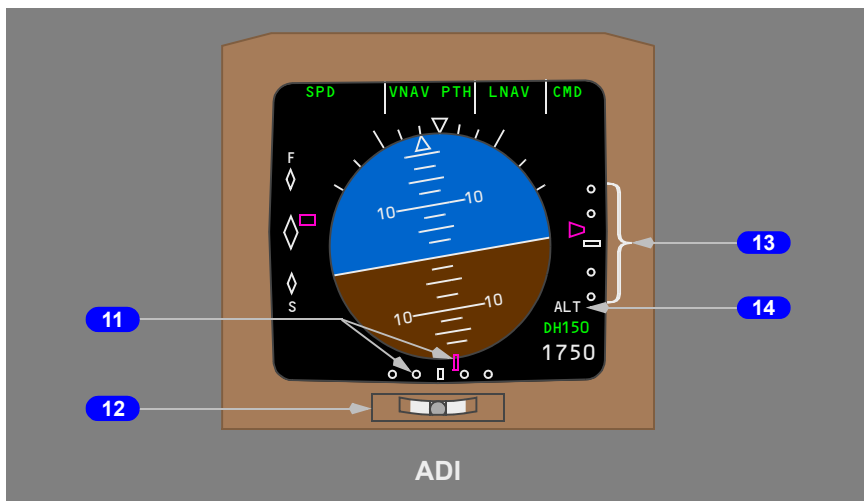

**1** Flight Mode Annunciations

Displays Autopilot Flight Director System (AFDS) mode status. Refer to Automatic Flight, Chapter 4, for description.

**1A** Autothrottle Annunciation

These airplane(s) have A/T annunciated below the thrust mode.

## **2 Bank Pointer and Scale**

Indicates IRS bank in reference to the bank scale.

## **3 Speed Tape**

### **Option: Speed tape**

Displays airspeed information. Refer to "ADI Speed Tape", this section, for description.

## **3 Fast/Slow Indicator**

### **Basic: Fast/slow airspeed indicator**

Displays airspeed information.

- indicates deviation from the airspeed selected by the FMC or the IAS/MACH selector, or limit speed
- small diamonds indicate 10 knots fast (F), or slow (S).

## **4 Horizon Line and Pitch Angle Scale**

Indicates the IRS horizon relative to the airplane symbol.

Pitch scale is in 2.5 degree increments.

## **5 Current Mach**

Displays current Mach.

- displays when Mach is 0.40 or above
- blanks when Mach is 0.38 or below.

## **5 Ground Speed**

Indicates ground speed in knots.

### **5A Ground Speed**

Indicates ground speed in knots.

## **6 Pitch Limit Indicator**

Indicates pitch limit (stick shaker activation point for the existing flight conditions).

- displays when flaps are extended.

## **7** Flight Director Command Bars

Indicates flight director pitch and roll steering commands.

- displays when the respective F/D switch is ON, valid command steering is available, and the selected flight director and autopilot in (CMD) are not the same
- blanks when the respective FD switch is OFF, or when command steering becomes invalid, or when the selected flight director and autopilot in (CMD) are the same.

## **8** Airplane Symbol

Indicates airplane attitude with reference to the IRS horizon.

## **9** Decision Height

Displays selected decision height.

- blanks when negative decision height is selected
- display changes from green to amber, increases in size and “DH” flashes momentarily when airplane descends below decision height (decision height alerting)
- decision height alert is reset automatically – if airplane climbs 75 feet or more above the selected decision height, or after the airplane lands
- decision height alert is reset manually – if the RST switch is pushed.

## **10** Radio Altitude

Displays radio altitude.

- blank above 2500 feet AGL
- changes color from white to amber when below selected decision height on descent
- changes color from amber back to white when airplane climbs 75 feet or more above the selected decision height, or after the airplane lands
- changes color from amber back to white when the RST switch is pushed.

## **11** Localizer Pointer and Deviation Scale

The localizer pointer indicates position relative to the airplane.

- scale indicates deviation
- pointer not displayed when localizer is unusable
- scale and pointer not displayed when an ILS frequency is not selected
- a two dot expanded localizer scale (not shown here) displays when LOC is engaged and deviation is slightly more than one half dot on the four dot scale. The expanded scale is more sensitive, with one dot deviation equal to one half dot deviation on the four dot scale

**12 Slip Indicator**

Indicates coordinated flight.

**13 Glide Slope Pointer and Deviation Scale**

The glideslope pointer indicates glideslope position relative to the airplane.

- scale indicates deviation
- pointer not displayed when glide slope unusable or when track and the front course on the ILS panel differ by more than 90°
- scale and pointer not displayed when an ILS frequency is not selected

**14 Height Alert**

**Options: Height alerting at 1,000, 1,500, or 2,500 feet.**

Indicates airplane has descended through a specified altitude.

- blanks if the RST switch is pushed.
- displays during descent from 2,500 feet to 500 feet AGL

**ADI Speed Tape**

**Option: Speed Tape with rolling digits.**

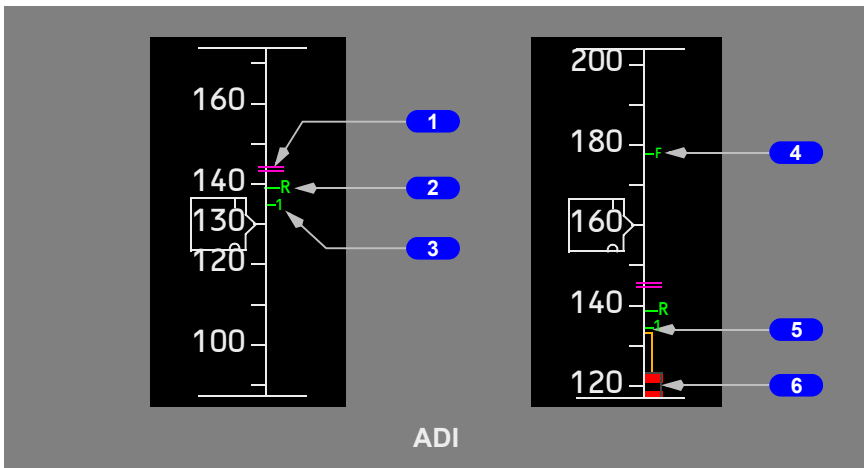

**1 FMC/MCP Command Airspeed Bug**

Displays when the FMC/MCP command airspeed as selected by the FMC or the IAS/MACH selector is in the displayed range.



## **2 VR (Rotation Speed) Bug**

Indicates rotation speed.

- displays after manual entry on the TAKEOFF REF page
- blanks 2 minutes after takeoff.

## **3 V1 (Decision Speed) Bug**

Indicates Decision Speed

- displays after manual entry on the TAKEOFF REF page
- replaces digital V1 display when V1 speed is within the displayed range
- blanks 2 minutes after takeoff.

## **4 VF (Maneuvering Speed) Bug**

- displays maneuvering speed for existing flap setting
- displays 10 seconds after takeoff
- if VF is within 4 knots of VR, both VR and V1 bugs are blanked
- blanks above 20,000 feet.

## **5 Minimum Maneuvering Speed**

Top of amber bar indicates minimum maneuvering speed. This airspeed provides:

- 1.3g maneuver capability to stick shaker below approximately 20,000 feet
- 1.3g maneuver capability to low speed buffet (or an alternative approved maneuver capability as preset by maintenance) above approximately 20,000 feet.

Displayed shortly after takeoff.

**Note:** 1.3g maneuver capability occurs at 40 degrees of bank in level flight.

## **6 Minimum Operating Speed**

Indicates the minimum operating speed

- below 20,000 feet - airspeed where stick shaker activates
- above 20,000 feet - initial buffet onset airspeed.

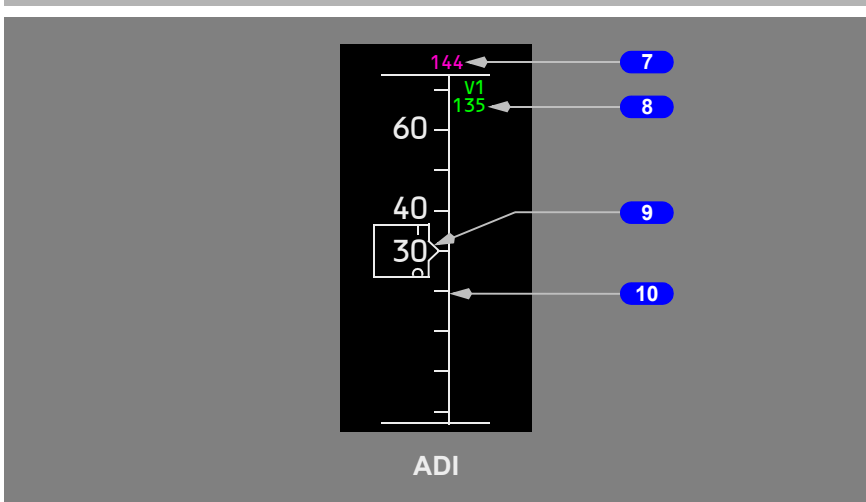

**7 FMC/MCP Command Airspeed**

Displays in this location when the FMC/MCP command airspeed bug as selected by the FMC or IAS/MACH selector is above the displayed range.

**8 V1 (Decision Speed)**

Indicates decision speed.

- displays after manual entry on the TAKEOFF REF page
- displays during initial takeoff roll when V1 is above the displayed range.

**9 Airspeed Pointer and Digital Display**

- indicates current airspeed when above 30 knots

**10 Speed Tape Scale**

Scrolls up or down in response to airspeed changes.

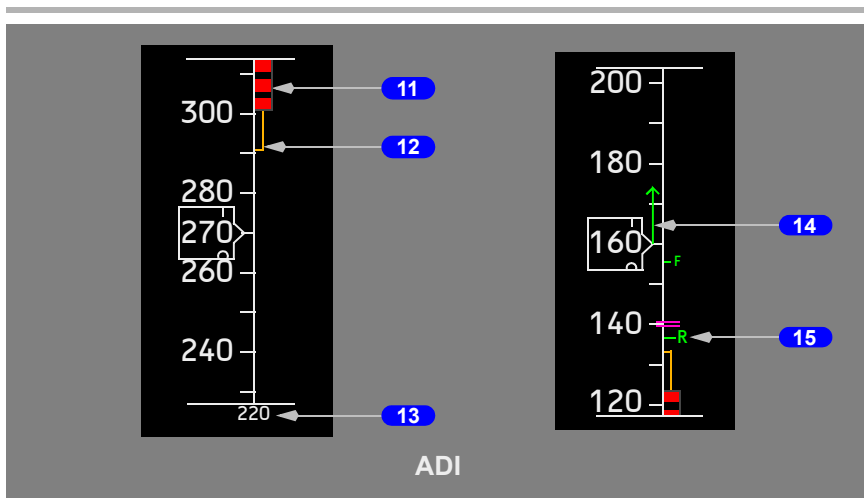

**11 Maximum Speed**

Indicates maximum permissible airspeed as limited by the lowest of the following:

- Vmo/Mmo
- landing gear placard speed
- flap placard speed.

**12 Maximum Maneuvering Speed**

Bottom of the amber bar indicates the maximum maneuvering speed. This airspeed provides 1.3g maneuver capability to high speed buffet (or an alternative approved maneuver capability set by maintenance). May be displayed when operating at high altitude at relatively high gross weights.

**Note:** 1.3g maneuver capability occurs at 40 degrees of bank in level flight.

**13 FMC/MCP Command Airspeed**

Displayed in this location when the FMC/MCP command airspeed bug as selected by the FMC or IAS/MACH selector is below the displayed range.

**14 Speed Trend Vector**

Indicates predicted airspeed in 10 seconds based on current acceleration or deceleration.

**15 Landing Reference Bug**

Displays the VREF speed as selected on the APPROACH REF page.



**DO NOT USE FOR FLIGHT** Flight Instruments, Displays - EFIS Controls and Indicators  
757 Flight Crew Operations Manual

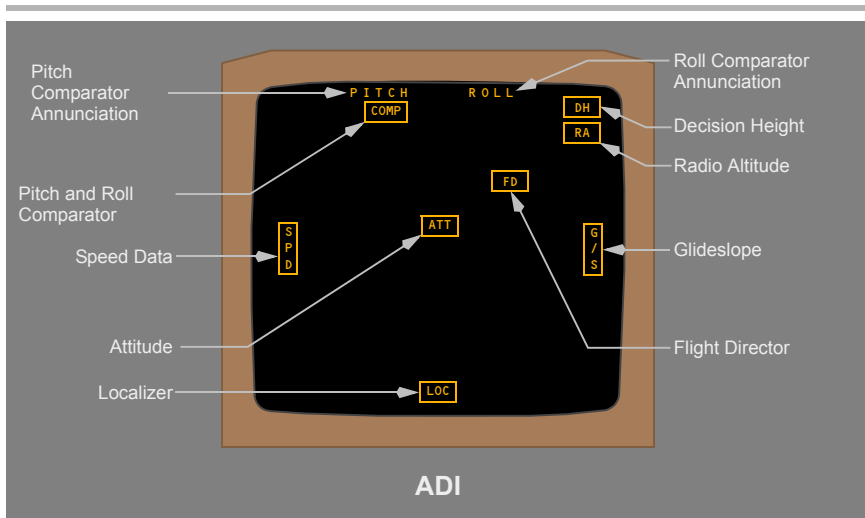



- 1** Distance to the Active Waypoint
- 2** Current Track
- 3** Heading Pointer
- 4** Weather Radar Returns
- 5** Wind Direction and Speed
- 6** Estimated Time of Arrival at the Active Waypoint
- 7** Weather Radar Annunciations
- 8** Magnetic/True Reference
- 9** Selected Heading Bug
- 10** Active LNAV Route
- 11** Vertical Pointer and Deviation Scale
- 12** Position Trend Vector
- 13** Airplane Symbol

Option: Map mode - Heading up

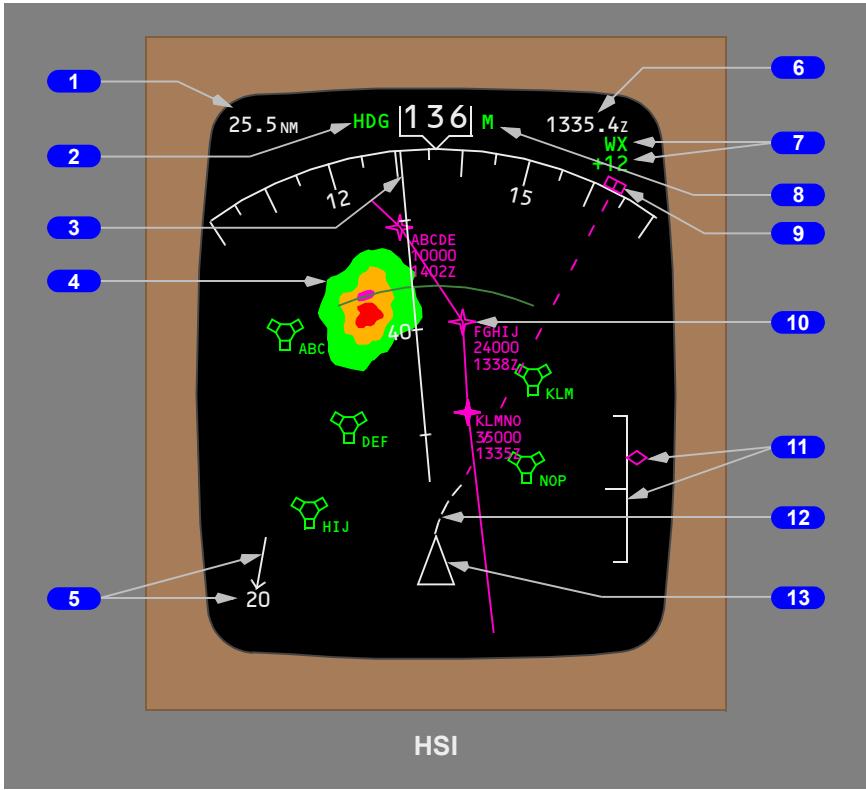



- 1** Distance to the Active Waypoint
- 2** Current Heading
- 3** Current Track Line
- 4** Weather Radar Returns
- 5** Wind Direction and Speed
- 6** Estimated Time of Arrival at the Active Waypoint
- 7** Weather Radar Annunciations
- 8** Magnetic/True Reference
- 9** Selected Heading Bug
- 10** Active LNAV Route
- 11** Vertical Pointer and Deviation Scale
- 12** Position Trend Vector
- 13** Airplane Symbol

## CTR MAP Mode

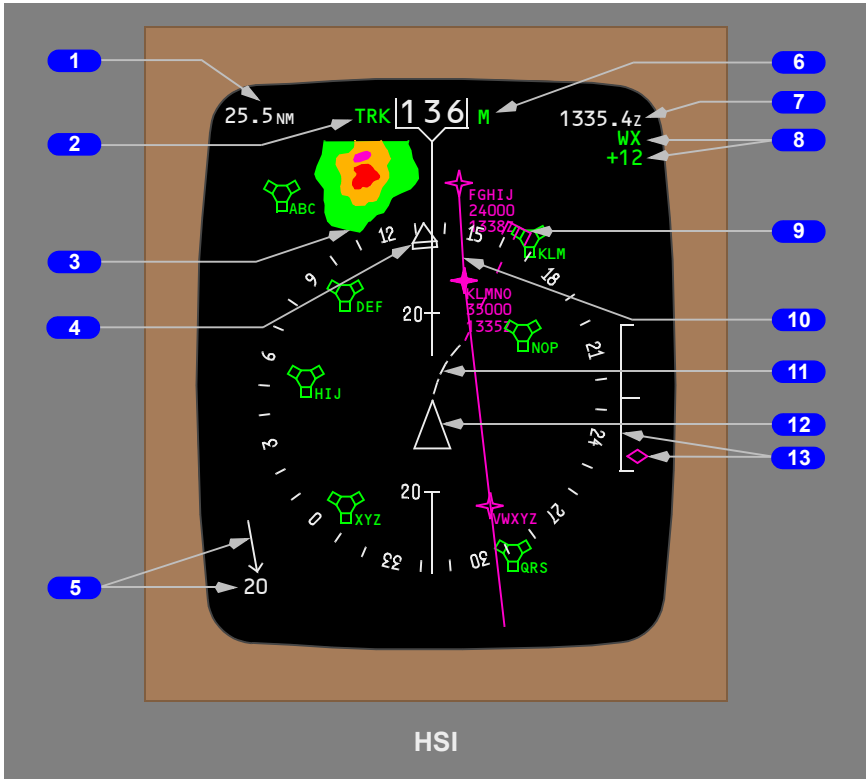

HSI

- 1** Distance to the Active Waypoint
- 2** Current Track
- 3** Weather Radar Returns
- 4** Heading Pointer
- 5** Wind Direction and Speed
- 6** Magnetic/True Reference
- 7** Estimated Time of Arrival at the Active Waypoint
- 8** Weather Radar Annunciations
- 9** Selected Heading Bug
- 10** Active LNAV Route
- 11** Position Trend Vector
- 12** Airplane Symbol
- 13** Vertical Pointer and Deviation Scale

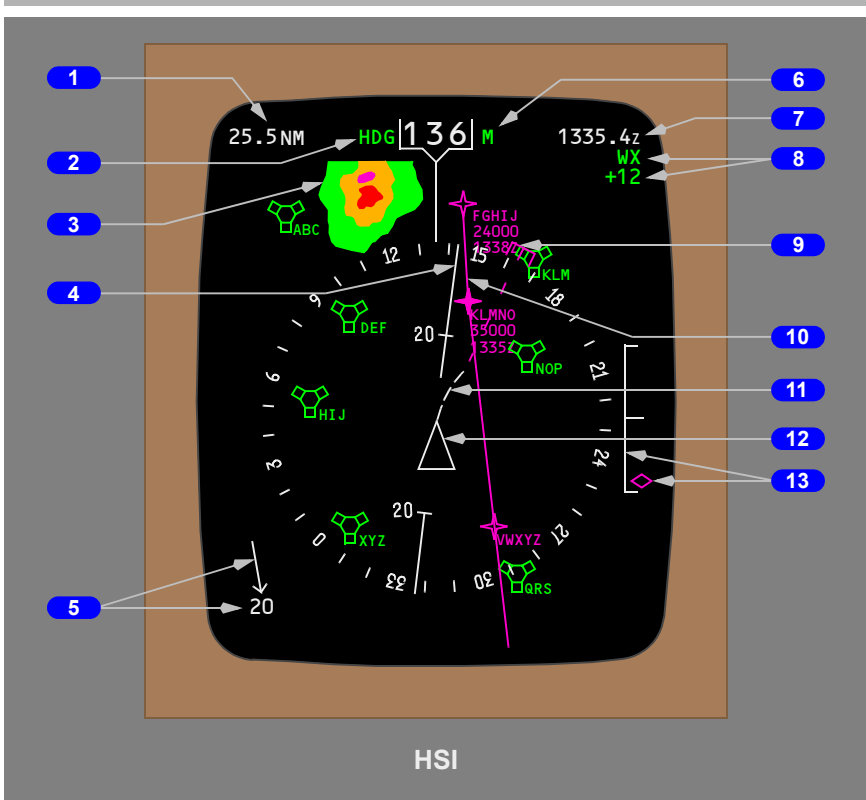

- 1** Distance to the Active Waypoint
- 2** Current Heading
- 3** Weather Radar Returns
- 4** Track Line
- 5** Wind Direction and Speed
- 6** Magnetic/True Reference
- 7** Estimated Time of Arrival at the Active Waypoint
- 8** Weather Radar Annunciations
- 9** Selected Heading Bug
- 10** Active LNAV Route
- 11** Position Trend Vector
- 12** Airplane Symbol
- 13** Vertical Pointer and Deviation Scale

## APP Mode

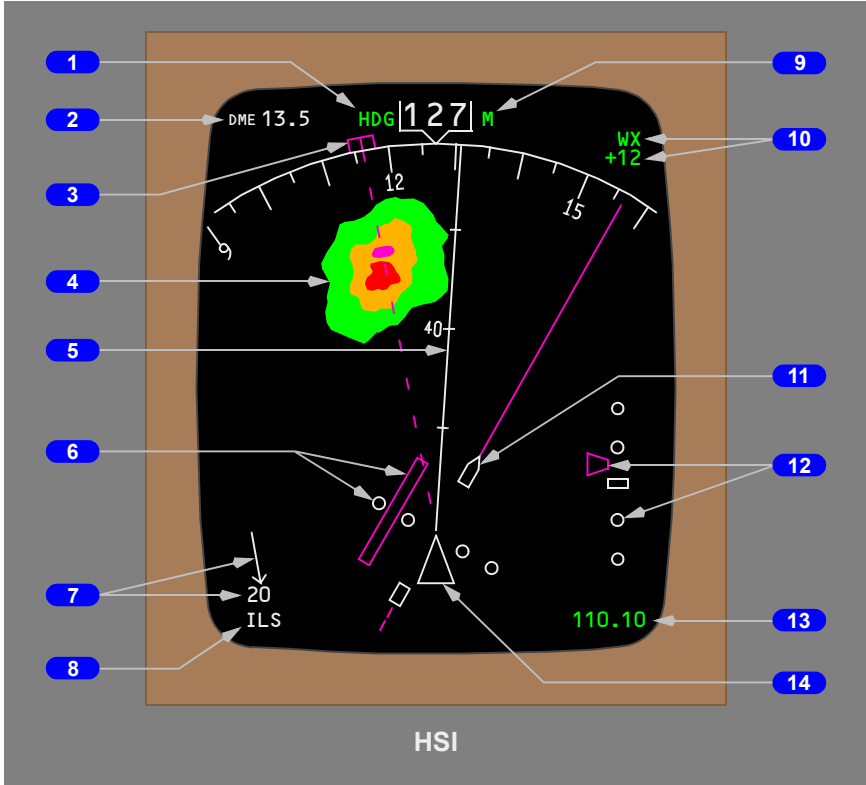

- 1** Current Heading
- 2** Reference ILS DME
- 3** Selected Heading Bug
- 4** Weather Radar Returns
- 5** Track Line
- 6** Course Deviation Indicator and Deviation Scale
- 7** Wind Direction and Speed
- 8** Reference ILS Receiver
- 9** Magnetic/True Reference
- 10** Weather Radar Annunciations
- 11** Selected Course Pointer
- 12** Glideslope Pointer and Deviation Scale
- 13** Reference ILS Frequency
- 14** Airplane Symbol

**CTR APP Mode**

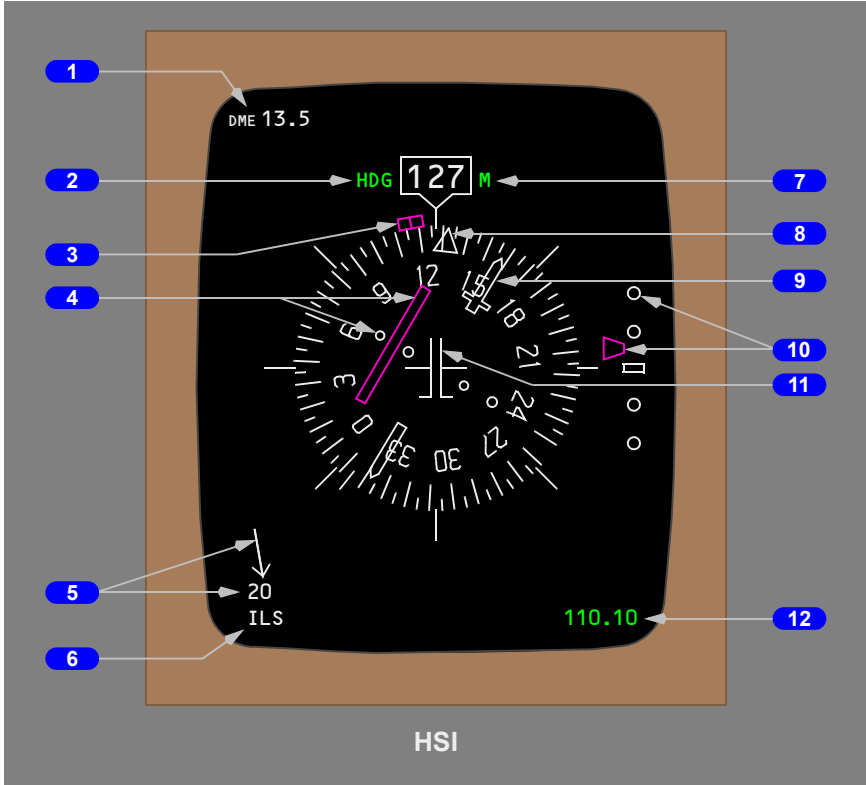



- 1** Reference ILS DME
- 2** Current Heading
- 3** Selected Heading Bug
- 4** Course Deviation Indicator and Deviation Scale
- 5** Wind Direction and Speed
- 6** Reference ILS Receiver
- 7** Magnetic/True Reference
- 8** Drift Angle Pointer
- 9** Selected Course Pointer
- 10** Glideslope Pointer and Deviation Scale
- 11** Airplane Symbol
- 12** Reference ILS Frequency

## VOR Mode

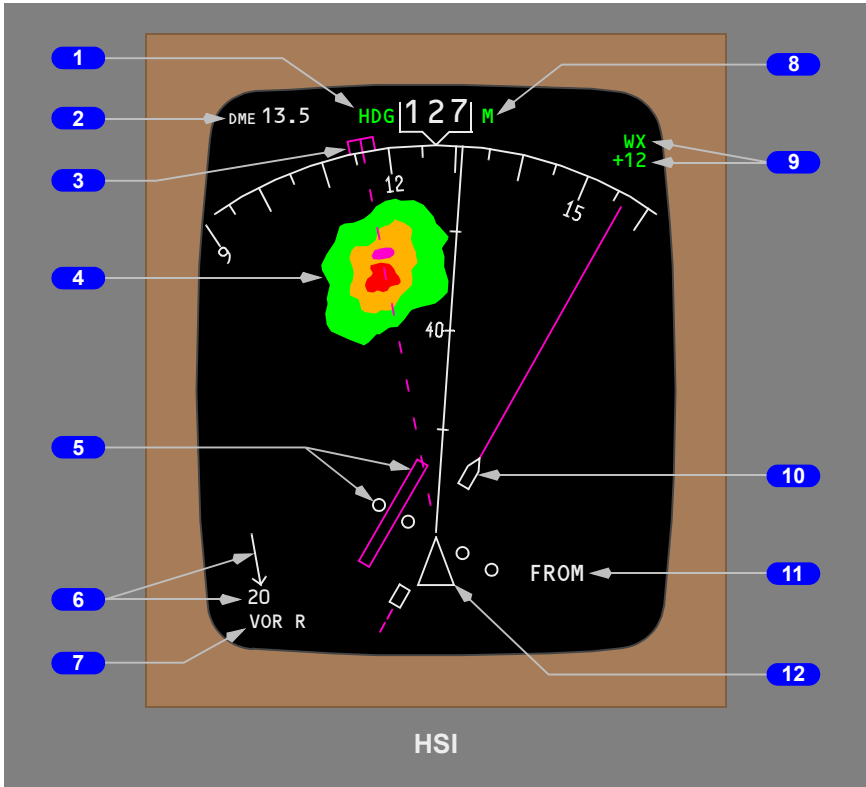

- 1** Current Heading
- 2** Reference VOR DME
- 3** Selected Heading Bug
- 4** Weather Radar Returns
- 5** Course Deviation Indicator and Deviation Scale
- 6** Wind Direction and Speed
- 7** Reference VOR Receiver
- 8** Magnetic/True Reference
- 9** Weather Radar Annunciations
- 10** Selected Course Pointer
- 11** TO/FROM Indication
- 12** Airplane Symbol

## CTR VOR Mode

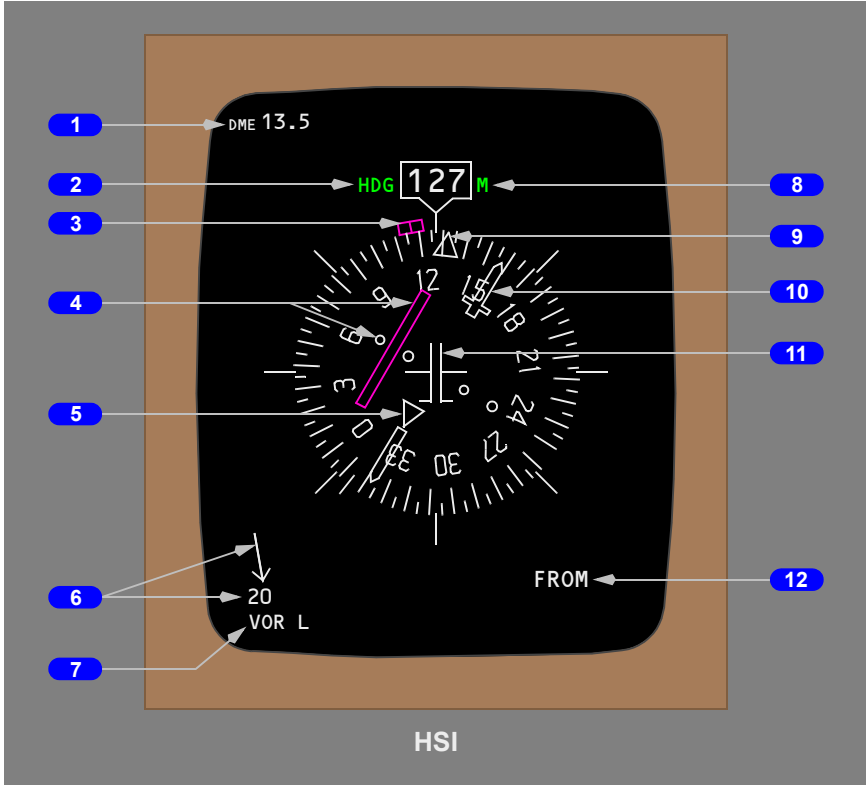

- 1** Reference VOR DME
- 2** Current Heading
- 3** Selected Heading Bug
- 4** Course Deviation Indicator and Deviation Scale
- 5** To/From Pointer
- 6** Wind Direction and Speed
- 7** Reference VOR Receiver
- 8** Magnetic/True Reference
- 9** Drift Angle Pointer
- 10** Selected Course Pointer
- 11** Airplane Symbol
- 12** TO/FROM Indication

## PLAN Mode

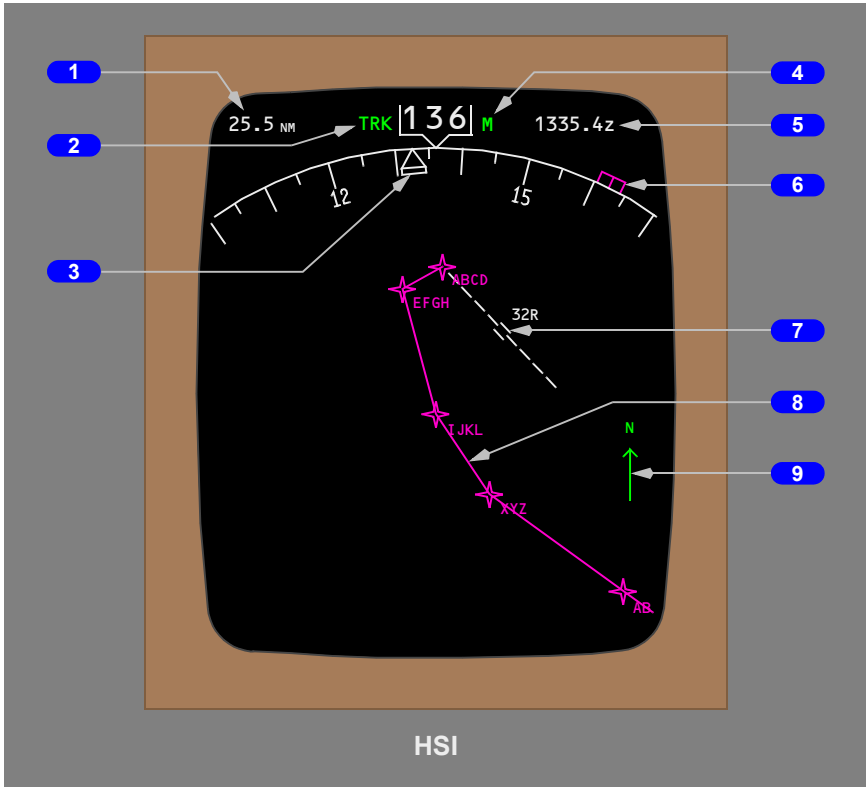

- 1** Distance to the Active Waypoint
- 2** Current Track
- 3** Heading Pointer
- 4** Magnetic/True Reference
- 5** Estimated Time of Arrival at the Active Waypoint
- 6** Selected Heading Bug
- 7** Airport and Runway
- 8** Active LNAV Route
- 9** True North Pointer

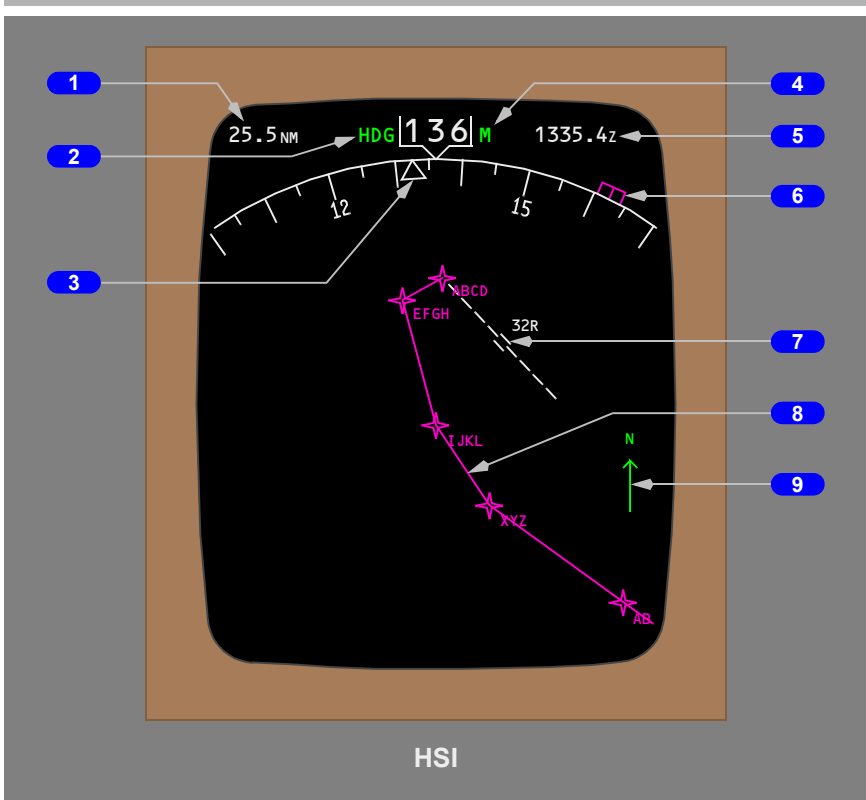

- 1 Distance to the Active Waypoint
- 2 Current Heading
- 3 Drift Angle Pointer
- 4 Magnetic/True Reference
- 5 Estimated Time of Arrival at the Active Waypoint
- 6 Selected Heading Bug
- 7 Airport and Runway
- 8 Active LNAV Route
- 9 True North Pointer









## HSI Symbolology



The following symbols can be displayed, depending on EFIS control panel switch selections. Colors indicate the following:

- W (white) – present status, range scales
- G (green) – active or selected mode and/or dynamic conditions
- M (magenta) – command information, pointers, symbols, fly-to condition, weather radar turbulence
- C (cyan) – nonactive or background information
- A (amber) – cautions, faults, flags
- R (red) – warnings
- B (black) – blank area, off condition.

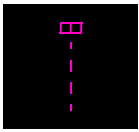

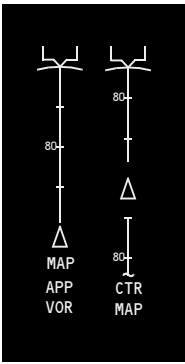
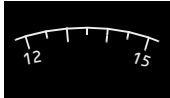

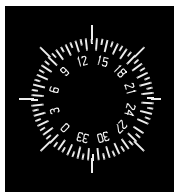
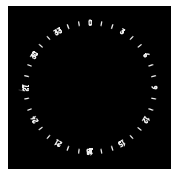
## Heading, Track, and Wind





Symbol	Name	Applicable Mode(s)	Remarks
	HDG – Heading orientation (G), current heading and pointer (W), heading reference (G)	All	HDG – Displays heading as the display orientation, current heading, M or TRU as the heading reference, and points to the heading on the compass rose.
	Track orientation (G), current track (W), and track reference (G)	MAP PLAN CTR MAP	Displays track as the display orientation, the current track, and M or TRU as the reference, and points to the heading on the compass rose.
	HDG – Heading orientation (G), current heading and pointer (W), heading reference (G)	VOR CTR VOR APP CTR APP	HDG – Displays heading as the display orientation, current heading, M or TRU as the heading reference, and points to the heading on the compass rose.

Symbol	Name	Applicable Mode(s)	Remarks
	Heading reference (G), box (W) in TRU, box (A) if TRU displayed in descents of 2,000 feet at more than 800 feet per minute.	All	Indicates heading/track is referenced to magnetic north or true north. On transition from TRU to M, a highlight box is displayed around M for 10 seconds. When TRU is the reference, the highlight box is displayed full time (W).
	Selected heading bug (M) and reference line (M)	MAP, CTR MAP VOR, APP  Bug only CTR VOR CTR APP PLAN	Displays the heading set in the MCP.  A dashed line (M) extends from the bug to the airplane symbol in the MAP and expanded modes.
	Current heading pointer (W)	MAP PLAN	Points to current heading on the compass rose.
	Track line and range scale (W)	MAP CTR MAP APP VOR	Displays present ground track based on airplane heading and wind. The displayed range numeric values are one-half and one-fourth (CTR MAP) the actual selected range. With heading-up orientation (VOR/APP mode), the track line will be rotated left or right at an angle equal to the drift angle.
	Expanded compass rose (W)	MAP PLAN  VOR APP	Displays 70 degrees of compass rose.

Symbol	Name	Applicable Mode(s)	Remarks
	Full compass rose (W) Fixed reference marks (W)	CTR VOR CTR APP	The compass rose rotates through 360 degrees as a function of airplane heading. Fixed reference marks are evenly spaced at 45 degree intervals.
	Center Map full compass rose (W)	CTR MAP	The compass rose rotates through 360 degrees as a function of airplane heading.
	Wind speed and direction. (W)	All except PLAN	Indicates wind speed and direction, with respect to display orientation and heading reference.

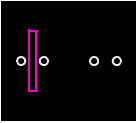
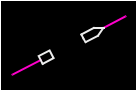
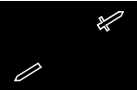
## Radio Navigation



Symbol	Name	Applicable Mode(s)	Remarks
	Airplane symbol (W)	VOR APP	Current airplane position is at the apex of the triangle.
	Airplane symbol (W)	CTR VOR CTR APP	Current airplane position is at the center of the symbol.
	Reference VOR receiver (G) Reference ILS receiver (G)	VOR CTR VOR APP CTR APP	Indicates the source of the displayed navigation data. In the VOR or APP mode the displayed data source is a function of the tuned frequency (VOR or LOC).
	Reference ILS frequency (G)	APP CTR APP	Displays frequency of manually tuned navaid.
	Reference VOR or ILS DME (W)	VOR CTR VOR APP CTR APP	Indicates DME distance to the reference navaid.

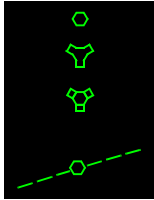

Symbol	Name	Applicable Mode(s)	Remarks
	Course deviation indicator (M) and deviation scale (W)	VOR CTR VOR APP CTR APP	Displays ILS or VOR course deviation.
	Selected course pointer (W) and line (M)	VOR APP	Displays selected course as set by the related VOR or ILS course selector.
	Selected course pointer (W)	CTR VOR CTR APP	Displays selected course as set by the related VOR or ILS course selector.
	Glideslope pointer (M) and deviation scale (W)	APP CTR APP	Displays glideslope position and deviation. Pointer not displayed when track and front course differ by more than 90°.
	To/from indication (W)	VOR CTR VOR	Displays VOR TO/FROM indication.
	To/from pointer (W)	CTR VOR	Displays VOR to/from direction.

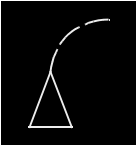
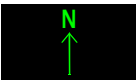
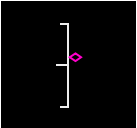
Symbol	Name	Applicable Mode(s)	Remarks
	<p>VOR (C, G), DME/TACAN (C, G), VORTAC (C, G) Manually tuned VOR radials (G)</p>	<p>MAP CTR MAP</p>	<p>When the EFIS control panel NAV AID switch is OFF, tuned navaids, excluding NDBs, are displayed (G).</p> <p>When the EFIS control panel NAV AID switch is selected ON, appropriate navaids are displayed. All navaids contained in the FMC data base and within the MAP area are displayed when the selected range is 10, 20 or 40 NM. Only high altitude navaids are displayed when the selected range is 80, 160, 320 NM. Navaids not being used are displayed in cyan.</p> <p>Tuned VHF navaids are displayed in green, regardless of switch selection. When a navaid is manually tuned, the selected course and reciprocal are displayed.</p>

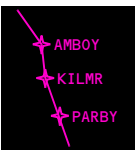
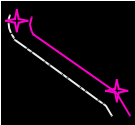

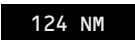
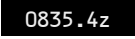

## Map

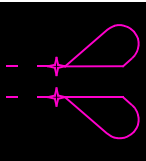
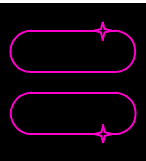

Symbol	Name	Applicable Mode(s)	Remarks
	Position trend vector (W) (dashed line) and airplane symbol (W).	MAP CTR MAP	Predicts position at the end of 30, 60, and 90 second intervals, based on bank angle and ground speed. Each segment represents 30 seconds. Selected range determines the number of segments displayed: <ul style="list-style-type: none"> <li>• Range &gt; 20 NM, 3 segments</li> <li>• Range = 20 NM, 2 segments</li> <li>• Range = 10 NM, 1 segment</li> </ul>
	North Pointer (G)	PLAN	Indicates orientation of map background to true north.
	Vertical pointer (M), and deviation scale (W)	MAP CTR MAP	Displays vertical deviation from selected VNAV PATH during descent only. Scale indicates +/- 400 feet deviation.

Symbol	Name	Applicable Mode(s)	Remarks
	Flight plan route: active (M), modified (W), inactive (C)	MAP PLAN CTR MAP	The active route is displayed with a continuous line (M) between waypoints.  Active route modifications are displayed with short dashes (W) between waypoints. After activation in the FMC, they are displayed as active routes.  Inactive routes are displayed with long dashes (C) between waypoints.
	Offset path and identifier: active route (M), modified route (W)		An offset route, selected through the FMC, is displayed with a dot-dash line (M) parallel to the active route.
	Standard Waypoint: active (M), inactive (W)		Active – represents the waypoint the airplane is currently navigating to.  Inactive – represents the waypoints on the active route.
	Route data: active waypoint (M), inactive waypoint (W)		When the EFIS control panel DATA switch is selected ON, altitude constraints and ETAs for route waypoints are displayed.
	Distance to the active waypoint (W)		Distance to the active waypoint.
	ETA at the active waypoint (W)		Indicates FMC-calculated ETA at the active waypoint.

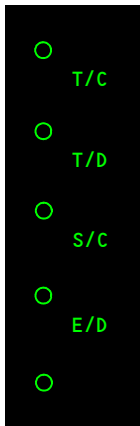
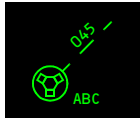
Symbol	Name	Applicable Mode(s)	Remarks
	Off route waypoint (C)	MAP PLAN CTR MAP	When the EFIS control panel WPT switch is selected on, waypoints not on the selected route are displayed, for ranges of 10, 20, or 40 NM.  When a range greater than 40NM is selected, only those waypoints associated with NDBs that are within 80NM of the airplane are displayed.
	Conditional Waypoint: active (M), inactive (W)	MAP PLAN	Active – represents the waypoint the airplane is currently navigating to.  Inactive – represents the waypoints on the active route.  Data with parentheses for conditional waypoints indicates type of conditional waypoint (ALTITUDE etc.)
	Procedure turn: active (M), modified (W), inactive (C)	MAP PLAN CTR MAP	A fixed size procedure turn appears when it is part of the displayed FMC route. When the procedure turn waypoint is active and the HSI range is 40 nm or less, the procedure turn changes to the correct scale size.
	Holding pattern: active route (M), modified route (W), inactive route (C)	MAP PLAN CTR MAP	A fixed size holding pattern appears when it is part of the displayed FMC route. When the holding waypoint is active and the HSI range is 80 nm or less, the holding pattern changes to the correct scale size.





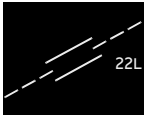

Symbol	Name	Applicable Mode(s)	Remarks
	Altitude range arc (G)	MAP CTR MAP	Based on present vertical speed and ground speed, indicates the approximate map position where the MCP altitude is reached.
	Energy management circles: clean (C), speedbrake (W)	MAP CTR MAP	Indicates clean and speedbrake energy management circles as defined on OFFPATH DES page.
	Altitude profile point and identifier (G)	MAP PLAN CTR MAP	Indicates the approximate map position of the FMC-calculated T/C (top-of-climb), T/D (top-of-descent), S/C (step climb), and E/D (end of descent) points.  Deceleration points have no identifier.
	Selected reference point and bearing information (G)	MAP PLAN CTR MAP	Displays the reference point selected on the CDU FIX page. Bearing from the fix is displayed with dashes (G).
	Selected reference point and distance information (G)	MAP PLAN CTR MAP	Displays the reference point selected on the CDU FIX page. Distance from the fix is displayed with dashes (G).

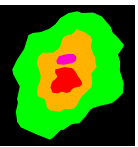
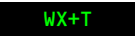
Symbol	Name	Applicable Mode(s)	Remarks
	Airport (C)	MAP PLAN CTRMAP	Displayed if the EFIS control panel ARPT switch is selected ON.  Origin and destination airports are always displayed, regardless of switch selection.
	Airport and runway (W)		Displayed when selected as the origin or destination and selected range is 80, 160, or 320 NM.
	Airport and runway (W)		Displayed when selected as the origin or destination and selected range is 10, 20, or 40 NM. Dashed runway centerlines extend 14.2 NM.



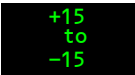



## Radar

Symbol	Name	Applicable Mode(s)	Remarks
	Weather radar (WXR) returns (R, A, G, M)	MAP CTR MAP VOR APP	The most intense areas are displayed in red, lesser intensity in amber, and lowest intensity green. Turbulence is displayed in magenta.
	WXR and turbulence mode (G)	MAP CTR MAP VOR APP	Weather radar system is selected on the EFIS control panel.  Weather radar mode, gain and tilt is controlled on the weather radar panel(s) (refer to Chapter 11, Flight Management, Navigation).

Symbol	Name	Applicable Mode(s)	Remarks
	WXR receiver gain (G)	MAP CTR MAP VOR APP	Weather radar system is selected on the EFIS control panel.  Weather radar mode, gain and tilt is controlled on the weather radar panel(s) (refer to Chapter 11, Flight Management, Navigation).
	Mode used with down-tilt when ground mapping (G)	MAP CTR MAP VOR APP	Weather radar system is selected on the EFIS control panel.  Weather radar mode, gain and tilt is controlled on the weather radar panel(s) (refer to Chapter 11, Flight Management, Navigation).
	WXR antenna tilt (G)	MAP CTR MAP VOR APP	Weather radar system is selected on the EFIS control panel.  Weather radar mode, gain and tilt is controlled on the weather radar panel(s) (refer to Chapter 11, Flight Management, Navigation).
	WXR test mode (C) (G)	MAP CTR MAP VOR APP	Weather radar mode, gain and tilt is controlled on the weather radar panel(s) (refer to Chapter 11, Flight Management, Navigation).



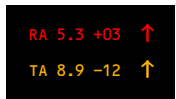



Symbol	Name	Applicable Mode(s)	Remarks
<b>WXR WEAK</b>	WXR calibration fault (A)	MAP	<p>When a degraded condition is present the EFIS will continue to display weather radar information.</p> <p>If any two or all degraded conditions occur simultaneously, the system will display only the highest priority condition as follows:</p> <ul style="list-style-type: none"> <li>• WEAK</li> <li>• ATT</li> <li>• STAB</li> </ul>
<b>WXR ATT</b>	WXR attitude input fault (A)		
<b>WXR STAB</b>	WXR stabilization off (A)		
<b>WXR DSPY</b>	WXR display fault. (A)	MAP	<p>HSI overheat or loss of digital unit cooling air when WXR is selected.</p> <p>Overheat annunciation has display priority over all other degraded conditions.</p> <p>Weather radar information removed after 30 seconds.</p>
<b>WXR RANGE DISAGREE</b>	WXR range status annunciations (A)	MAP CTR MAP VOR APP	Weather output range disagrees with the range selected by the EFIS control panel.
<b>MAP/WXR RANGE DISAGREE</b>	WXR range status annunciations (A)	MAP CTR MAP	Weather output range and map display output range disagree with selected EFIS control panel range.
<b>WXR FAIL</b>	WXR system failure (A)	MAP CTR MAP VOR APP	<p>Weather radar system failure is annunciated under any of the following conditions:</p> <ul style="list-style-type: none"> <li>• receiver transmitter failure</li> <li>• antenna failure</li> <li>• control panel failure</li> </ul>

**TCAS**

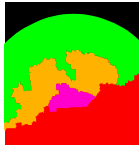
Symbol	Name	Applicable Mode(s)	Remarks
	TCAS resolution advisory (RA), relative altitude (R)	MAP CTR MAP APP VOR	<p>These symbols are displayed only when the EFIS control panel traffic (TFC) switch is selected on. Refer to Chapter 15, Warning Systems.</p> <p>The arrow indicates traffic climbing or descending at a rate greater than or equal to 500 fpm. At rates less than 500 fpm, the arrow is not displayed.</p> <p>The number and associated signs indicate altitude of traffic in hundreds of feet relative to the airplane.</p> <p>The number is below the traffic symbol when the traffic is below, and above the traffic symbol when the traffic is above the airplane. Absence of the number implies altitude unknown.</p>
	TCAS traffic advisory (TA), relative altitude (A)		
	TCAS proximate traffic, relative altitude (W)		
	TCAS other traffic, relative altitude (W)		
	TCAS no bearing message (RA-R, TA-A)	MAP CTR MAP APP VOR	Message provides traffic type, range in NM, altitude and vertical direction.
	TCAS traffic alert message (RA-R, TA-A)	All	Displayed whenever a TCAS RA or TA is active. EFIS control panel TFC switch does not have to be selected on.
	TCAS off scale message (RA-R, TA-A)	MAP CTR MAP APP VOR	Displayed whenever RA or TA traffic is outside the traffic area covered by the HSI range. Displayed only if the EFIS control panel TFC switch is selected on.



Symbol	Name	Applicable Mode(s)	Remarks
<b>TFC</b>	TCAS mode (G)	MAP CTRMAP APP VOR	Indicates the HSI TCAS display is active; the EFIS control panel TFC switch is selected on.
<b>TA ONLY</b>	TCAS mode (G)	All	Indicates TCAS computer is not computing RAs. Displayed whether the EFIS control panel TFC switch is selected on or off.
<b>TCAS TEST</b>	TCAS mode (W)	All	Indicates TCAS is operating in the test mode. Displayed whether EFIS control panel TFC switch is selected on or off.
<b>TCAS OFF</b>	TCAS off message (W)	MAP CTRMAP APP VOR	Displayed when the TCAS/ATC mode switch is not in TA ONLY or TA/RA. Not displayed if TCAS is failed.
<b>TCAS FAIL</b>	TCAS fail message (A)	MAP CTRMAP APP VOR	Indicates TCAS failure.

## Look-Ahead Terrain

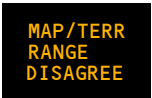
Symbol	Name	Applicable Mode(s)	Remarks
	Terrain display (R, A, G, M)	MAP CTR MAP VOR APP	Displays terrain data from the GPWS terrain data base.  The terrain displays as follows: 2,000 feet below to 500 feet (250 feet with gear down) below the airplane's current altitude (G), 500 feet (250 feet with gear down) below to 2000 feet above the airplane's current altitude (A), more than 2,000 feet above the airplane's current altitude (R), no terrain data available (M).  Color and density vary based on terrain height vs. airplane altitude.
	Terrain annunciation (R, A)	All	Look-ahead terrain caution alert active (A), look-ahead terrain warning alert active (R).
	Look-ahead mode annunciation (C)	MAP CTR MAP VOR APP	GPWS look-ahead display enabled (manual or automatic display).
	Look-ahead status annunciations (A)	MAP CTR MAP VOR APP	Look-ahead terrain alerting and display have failed.
			Look-ahead terrain alerting and display unavailable due to position uncertainty.
			GPWS terrain override switch in OVRD position.
	Terrain test mode annunciation (C)	All	GPWS operating in self-test mode.

Symbol	Name	Applicable Mode(s)	Remarks
	Terrain range status annunciations (A)	MAP CTR MAP VOR APP	Terrain output range disagrees with selected EFIS control panel range.
	Terrain range status annunciations (A)	MAP CTR MAP	Terrain output range and map display output range disagree with selected EFIS control panel range.

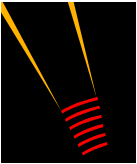
### Predictive Windshear

Symbol	Name	Applicable Mode(s)	Remarks
	Predictive windshear symbol (R, B, A)	MAP CTR MAP VOR APP	Displays windshear location and approximate geometric size (width and depth).  Amber radials extend from predictive windshear symbol to help identify location of windshear event.
	Windshear annunciation (R, A)	All	Predictive windshear caution active (A).  Predictive windshear warning active (R).



## HSI Failure Flags and Annunciations

**Note:** HSI failure flags replace the appropriate display to indicate source system failure, or lack of computed information.

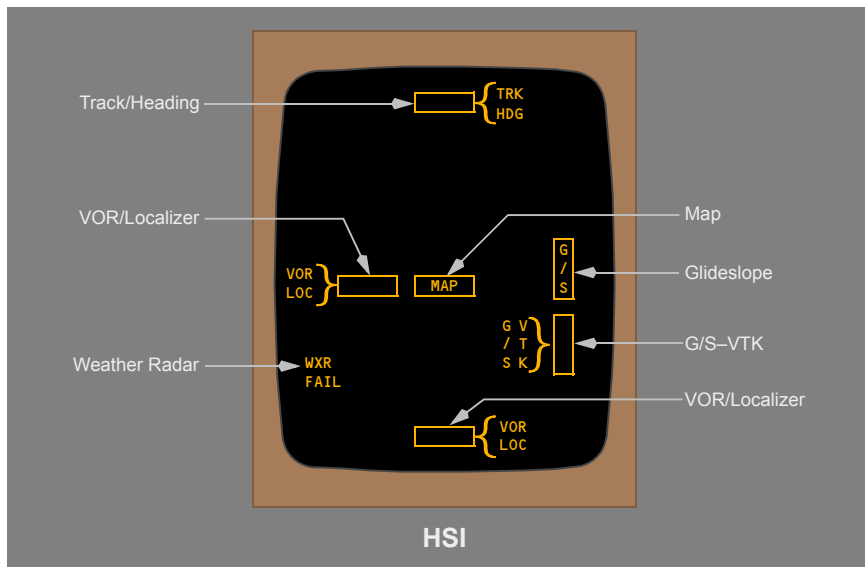
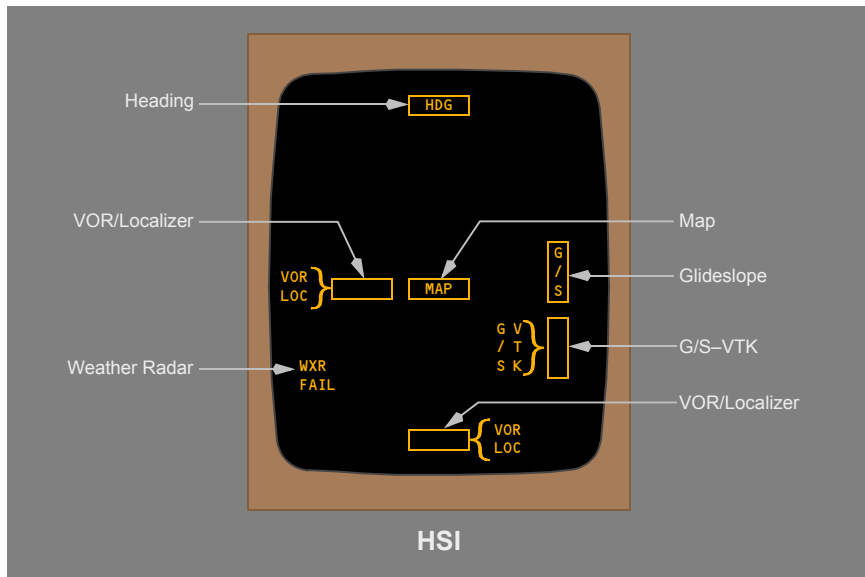

## Instrument Switching

Various source selections are available for instrument displays. For other related instrument transfer switching, refer to Chapter 11, Flight Management, Navigation.

### Left Instrument Source Selector Panel (Upper)

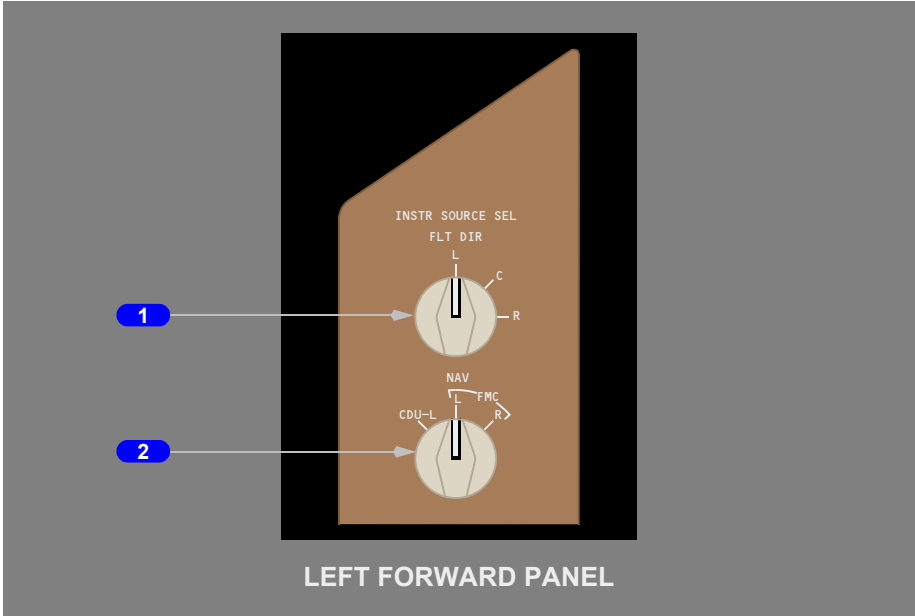

#### 1 Flight Director (FLT DIR) Source Selector

Selects the flight control computer (left, center, or right) used as the source of commands for the captain's flight director display.

#### 2 Navigation (NAV) Source Selector

Selects the source of FMC information used by the left and center EFIS symbol generators and the left and center flight control computers (FCCs).

- FMC L – normal position. Provides information to the left and center symbol generators, and to the left and center FCCs
- FMC R – alternate position. Provides information to the left and center symbol generators, and to the left and center FCCs
- CDU L – provides information to the left and center symbol generators. Used for operation of the Alternate Navigation System (refer to Chapter 11, Flight Management, Navigation)

## Left Instrument Source Selector Panel (Lower)

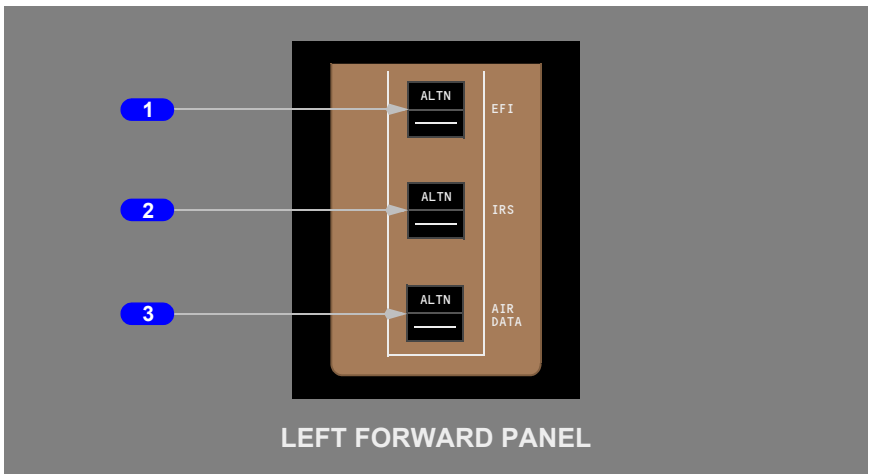

### 1 Electronic Flight Instruments (EFI) Switch

Selects the EFIS symbol generator, ILS receiver, and radio altimeter used as the sources of information for the captain's ADI and HSI displays.

- Blank – normal position. The captain's displays use the left symbol generator, left ILS receiver, and left radio altimeter
- ALTN – alternate position. The captain's displays use the center symbol generator, center ILS receiver, and center radio altimeter

If both pilots select ALTN (both using center sources):

- both pilots' ADI and HSI displays are controlled by the left EFIS control panel
- the EICAS message INSTR SWITCH displays

### 2 Inertial Reference System (IRS) Switch

Selects the IRS used as the source of information for the left symbol generator, the captain's VSI, and the first officer's RDMI. Information provided by the IRS includes attitude, heading, and vertical speed

- Blank – normal position. The left IRS is the source for the left and center symbol generators, the captain's VSI, and first officer's RDMI
- ALTN – alternate position. The center IRS is the source for the left and center symbol generators, the captain's VSI, and the first officer's RDMI

**3 AIR DATA Switch**

Selects the air data computer used as the source of information for the captain's Mach/airspeed indicator, ADI speed tape, primary and metric altimeters, and vertical speed indicator (via the selected IRS).

- Blank – normal position. The left air data computer is the source for the captain's air data instruments
- ALTN – alternate position. The right air data computer is the source for the captain's air data instruments

**Right Instrument Source Selector Panel (Upper)**

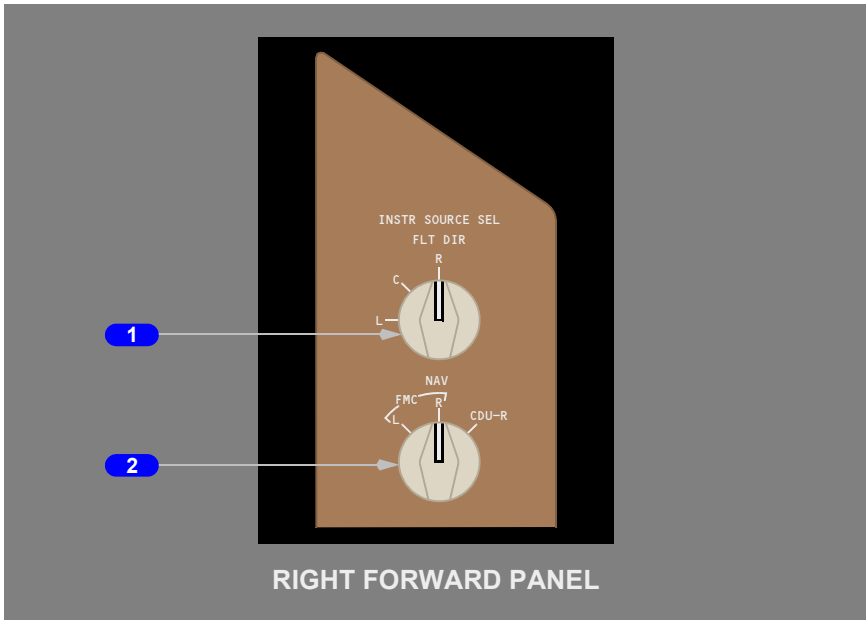

**1 Flight Director (FLT DIR) Source Selector**

Selects the flight control computer (left, center, or right) used as the source of commands for the first officer's flight director display.

## 2 Navigation (NAV) Source Selector

Selects the source of FMC information used by the right EFIS symbol generators and the right flight control computer (FCC).

- FMC R – normal position. Provides information to the right symbol generator, and to the right FCC
- FMC L – alternate position. Provides information to the right symbol generator, and to the right FCC
- CDU R – provides information to the right symbol generator. Used for operation of the Alternate Navigation System (refer to Chapter 11, Flight Management, Navigation)

### Right Instrument Source Selector Panel (Lower)

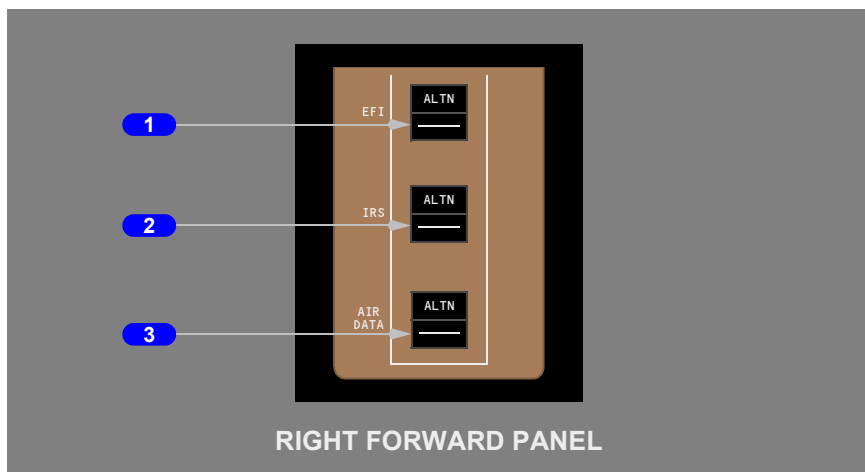

### 1 Electronic Flight Instruments (EFI) Switch

Selects the EFIS symbol generator, ILS receiver, and radio altimeter used as the sources of information for the first officer's ADI and HSI displays.

- Blank – normal position. The first officer's displays use the right symbol generator, right ILS receiver, and right radio altimeter
- ALTN – alternate position. The first officer's displays use the center symbol generator, center ILS receiver, and center radio altimeter

If both pilots select ALTN (both using center sources):

- both pilots' ADI and HSI displays are controlled by the left EFIS control panel
- the EICAS message INSTR SWITCH is displayed

## **2 Inertial Reference System (IRS) Switch**

Selects the IRS used as the source of information for the first officer's EFIS symbol generator and VSI, and the captain's RDMI. Information provided by the IRS includes attitude, heading, and vertical speed.

- Blank – normal position. The right IRS is the source for the right symbol generator, the first officer's VSI, and the captain's RDMI
- ALTN – alternate position. The center IRS is the source for the right symbol generator, the first officer's VSI, and the captain's RDMI

## **3 AIR DATA Switch**

Selects the air data computer used as the source of information for the first officer's Mach/airspeed indicator, primary altimeter, and vertical speed indicator (via the selected IRS).

- Blank – normal position. The right air data computer is the source for the first officer's air data instruments
- ALTN – alternate position. The left air data computer is the source for the first officer's air data instruments

## EFI/IRS Interface Diagram

The following diagram shows the normal EFI/IRS interface. EFI switching determines the center symbol generator (C-SG) input and output. Normally, left system instrument sources supply the center symbol generator. When both pilots select ALTN with their EFI switches, the left system instrument sources supply data to the center symbol generator. However, the center symbol generator always uses the center ILS and center radio altimeter. Each EFIS control panel is connected to the symbol generator with the EFI switch. Each IRS switch permits pilot selection of the alternate data source for heading, attitude, and vertical speed.

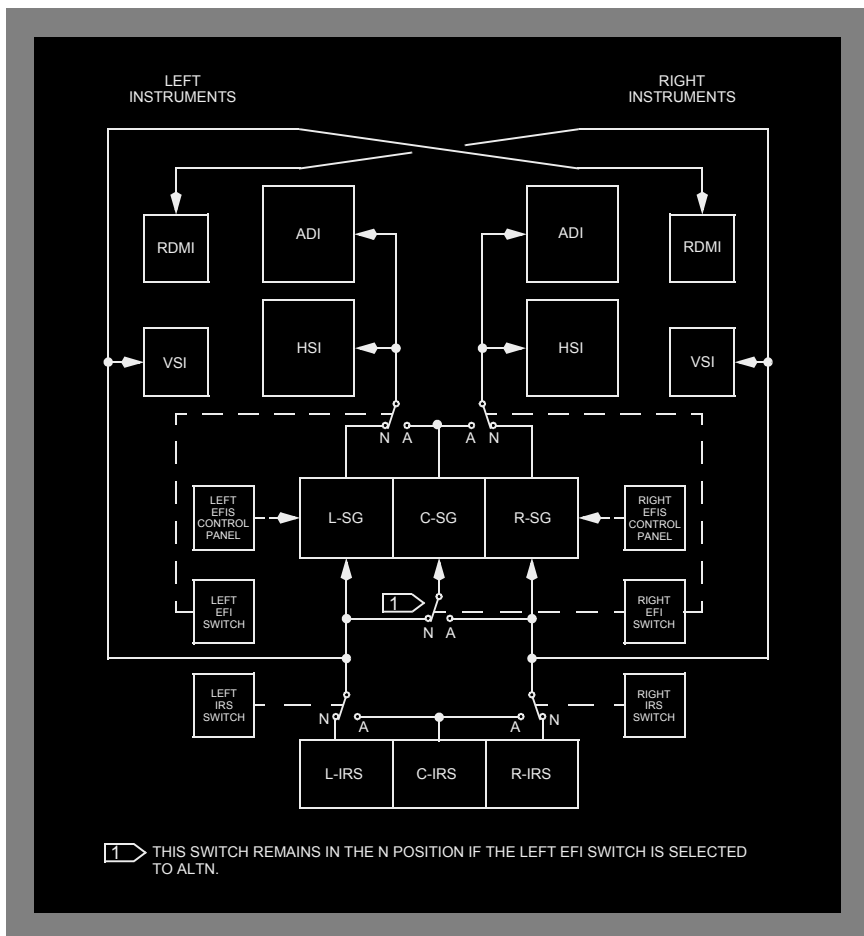

## Heading Reference Switch

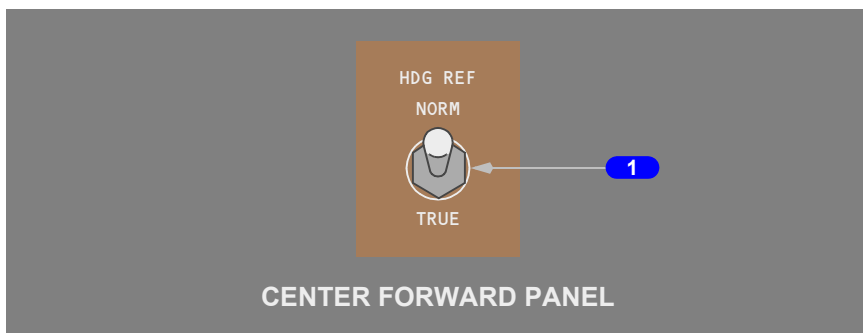

### 1 Heading Reference (HDG REF) Switch

NORM –

- references each compass card to magnetic north when operating outside polar regions
- references each HSI to true north and causes each RDMI heading flag to appear when operating within polar regions

TRUE – references each compass card to true north regardless of latitude.



## EFIS Control Panel

The left EFIS control panel controls the left ADI and HSI. The right EFIS control panel controls the right ADI and HSI.

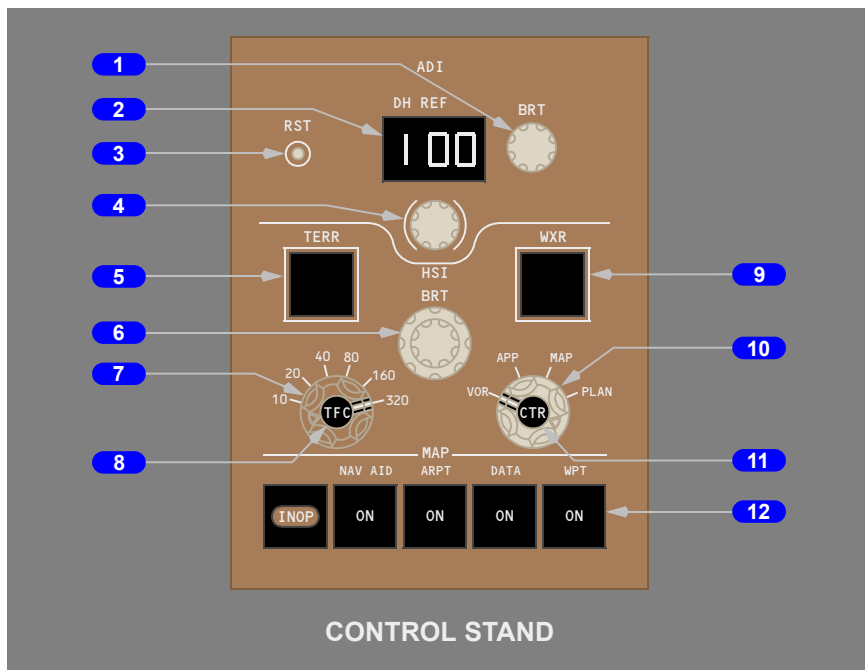

### 1 ADI Brightness (BRT) Control

Rotate – adjusts brightness of ADI display.

### 2 Decision Height Reference (DH REF) Window

- displays selected decision height
- displays on ADI (ADI blanks when a negative decision height is selected)

### 3 Decision Height Reset (RST) Switch

Push –

- resets DH alert on related ADI
- changes RA display from amber to white
- blanks height alert on related ADI

### 4 Decision Height Selector

Rotate – selects decision height for DH alerting.

## **5 Terrain (TERR) Switch**

Push –

- displays terrain data on the HSI in MAP, CTR MAP, VOR, and APP
- deselects the weather radar display regardless of the mode selector position

For a description of the ground proximity warning system, refer to Chapter 15, Warning Systems.

## **6 HSI Brightness (BRT) Control**

Rotate –

- outer control – adjusts overall brightness of HSI display
- inner control – adjusts brightness of weather radar or terrain display

## **7 HSI Range Selector**

Rotate –

- selects nautical mile range for MAP, CTR MAP, and PLAN displays
- when the WXR switch or TCAS TFC switch is ON, also selects the desired range for the VOR and APP mode displays

## **8 Traffic (TFC) Switch**

Push –

- displays TCAS traffic information on HSI
- second push removes traffic display

**Note:** TCAS must be activated on the Transponder Panel (refer to Chapter 11, Flight Management, Navigation).

## **9 Weather Radar (WXR) Switch**

Push –

- displays weather radar information (refer to Chapter 11, Flight Management, Navigation)
- second push disables weather radar display

## **10 HSI Mode Selector**

VOR, CTR VOR –

- displays VOR navigation information
- selects manual VOR and DME tuning on the VOR/DME panel (automatic tuning inhibited)

APP, CTR APP –

- displays ILS navigation information
- selects manual VOR and DME tuning on the VOR/DME panel (automatic tuning inhibited)

MAP, CTR MAP –

- displays a dynamic map
- allows selection of manual or automatic VOR and DME tuning on the VOR/DME panel
- allows remote manual VOR and DME tuning on the PROGRESS page

PLAN –

- displays static FMC map in true–north–up orientation
- displays heading information in heading–up form
- allows selection of manual or automatic VOR and DME tuning on the VOR/DME panel
- allows remote manual VOR and DME tuning on the PROGRESS page
- activates the MAP CTR STEP prompt on the LEGS page for stepping through the displayed route

### **11 Center (CTR) Switch**

Push –

- when the HSI Mode Selector is in the MAP, VOR, or APP positions, toggles between full and expanded rose displays
- does not affect display in PLAN mode

### **12 Map Switches**

NAV AID –

- displays only high altitude VHF navigation aids when HSI range is 80nm or greater
- displays all VHF navigation aids when HSI range is 40nm or less

Airport (ARPT) –

Displays all airports in the display range.

DATA –

Displays estimated time of arrival and any altitude constraint for each waypoint in the displayed flight path.

Waypoint (WPT) –

- displays all waypoints when HSI range is 40nm or less
- those waypoints associated with NDBs are displayed at any selected range as long as the NDBs are within 80nm of the airplane.

Intentionally  
Blank

---

**Introduction**

The electronic flight instrument system (EFIS) consists of three (L, C, R) symbol generators (SGs), two control panels (CPs), two attitude director indicators (ADIs), two horizontal situation indicators (HSIs), and ambient light sensing units. The EFIS uses information provided by a variety of aircraft systems to generate the appropriate visual presentations on the ADI and HSI. Data relating primarily to navigation is provided by aircraft systems such as the navigation radios, flight management computer (FMC), and the inertial reference systems. Data relating primarily to automatic flight is provided by the flight control computers (FCCs), the autothrottle (A/T), and the FMC.

Data which is used to display current aircraft state information is provided by the two air data computers (ADCs) and the three inertial reference systems (IRSs).

Automatic adjustment of the display intensity for each display unit is provided by the ambient light sensing units. Flight crew control of the EFIS displays is accomplished by positioning the various controls on the respective EFIS control panels to the desired settings. For information on EFIS/IRS interface, and instrument switching see Section 10, of this chapter.

**EFIS Symbol Generators**

Three symbol generators form the heart of the EFIS. The SGs receive inputs from various aircraft systems, then generate the proper visual displays for the related ADI and HSI. Each pilot's ADI and HSI displays are provided from the SG selected with their respective EFI switch. The left SG normally provides the captain's displays, and the right SG normally provides the first officer's displays. The center SG is available as an alternate source for either or both pilots.

**EFIS Control Panels**

The EFIS control panels control display options, modes, ranges and brightness for the respective ADIs and HSIs.

---

**Attitude Director Indicator**

The ADI presents conventional displays for attitude (pitch and roll), flight director commands, localizer deviation and glide slope deviation. In addition, the ADI displays information relating to autoflight system mode annunciations, airplane speed, pitch limit, radio altitude, and decision height.

The captain's attitude information is provided by the left IRS and the first officer's information is provided by the right IRS. The center IRS provides that data as an alternate source.

## **Attitude Display**

Airplane attitude data is provided by the IRSs. The IRSs' pitch and roll attitude information is valid throughout 360 degrees of rotation in each axis.

## **Mode Annunciations**

Mode annunciations for the A/T and the AFDS are displayed at the bottom of the ADI displays. For a detailed description of the various autoflight mode annunciations and their meanings, refer to Chapter 4, Automatic Flight.

Mode annunciations for the A/T and the AFDS are displayed at the top of the ADI displays. For a detailed description of the various autoflight mode annunciations and their meanings, refer to Chapter 4, Automatic Flight.

## **Flight Director Commands**

Flight director guidance commands from the selected FCC are displayed via the flight director symbol on the ADI. A flight director failure in either axis causes the respective command bar to disappear. If both axes become unreliable, both command bars disappear and the FD flag appears.

## **Glide Slope and Localizer Deviation Displays**

Conventional ILS information is provided from the ILS receiver selected with each pilot's EFI switch. All three ILS receivers are commonly tuned on the ILS panel.

## **Attitude Comparator**

The EICAS caution message ATT DISAGREE displays when a difference of more than 3 degrees between the captain's and first officer's pitch or roll displays is detected. An amber PITCH or ROLL alerting annunciation is displayed on both ADIs for the parameter that is out of tolerance. Attitude comparison monitoring is inhibited when both pilots are using the center symbol generator by selecting ALTN on the EFI switches.

## **Height Alert**

The height alert ALT is triggered when the airplane descends below 2,500 feet AGL. The alert is turned off when the airplane continues to descend below 500 feet AGL or climbs above 2,500 feet AGL, or after pressing the decision height reset switch on the EFIS control panel.

## Radio Altitude and Decision Height

When radio altitude is less than 2,500 feet AGL, a digital display is depicted on the ADI. At all other times, the digital radio altitude display is blanked.

When a positive decision height has been selected on the related EFIS control panel, the letters DH and the decision height are displayed just above the digital radio altitude display of the associated ADI.

When descending through the selected decision height, a decision height alert occurs. The display changes from green to amber, increases in size and DH flashes momentarily.

The decision height alert is reset if any one of the following occurs:

- the DH reset switch on the EFIS control panel is pressed
- the radio altitude increases to decision height +75 feet
- the radio altitude is equal to zero feet (i.e. during touchdown).

## Pitch Limit Indicator

The position of the pitch limit indicator is a function of the stall warning computer. It is programmed so that stick shaker activation will coincide with a pitch attitude equal to the pitch limit indication.

## Ground Speed Display

A digital presentation of the current ground speed is displayed. The ground speed data is received from the FMC or the IRS, with the FMC being the primary source.

## Airspeed Display

The Fast/Slow pointer is positioned by the thrust management computer. For additional details see Chapter 4, Automatic Flight.

Airspeed is displayed on a tape on the ADI. The current Mach number is digitally displayed below the airspeed tape when the current Mach number is greater than 0.40.

The selected airspeed, takeoff and landing reference speeds, and flap maneuvering speeds are shown on the airspeed tape. Maximum and minimum airspeeds are also displayed on the airspeed tape.

**CAUTION: Reduced maneuver capability exists when operating within the amber regions below the minimum maneuvering speed or above the maximum maneuvering speed. During non-normal conditions the target speed may be below the minimum maneuvering speed.**

## Horizontal Situation Indicator (HSI)

The HSI presents an electronically generated color display of navigational data. Each HSI is capable of showing the airplane's progress on a dynamic map display.

### Display Orientation

During normal operation, heading reference data is supplied to each HSI from the respective IRS.

The compass rose can be referenced to magnetic north or true north. The heading reference switch is used to manually select magnetic or true reference. The compass display is automatically referenced to true north when the airplane is operating within polar regions.

### Track

Airplane track data is supplied by the FMC during normal operation and by the CDU when in alternate navigation.

### MAP Mode

The MAP mode is recommended for most phases of flight.

Presented track up, this mode shows airplane position relative to the route of flight against a moving map background.

Presented heading up, this mode shows airplane position relative to the route of flight against a moving map background.

Displayed information can include:

- track
- heading
- wind
- routes
- position trend vector
- altitude range arc
- estimated time of arrival
- selected navigation data points programmed in the FMC

### VOR Mode

The VOR mode is presented heading up. The VOR mode displays track, heading, and wind speed and direction with VOR navigation information.

### APP Mode

The APP mode is presented heading up. The APP mode displays track, heading, and wind speed and direction with ILS approach information.



## **PLAN Mode**

The PLAN mode is presented true north up. The active route may be viewed using The STEP prompt on the LEGS pages.

## **Weather Radar Display**

Display of weather radar returns on the HSI is enabled or disabled by the WXR switch on the respective EFIS control panel. The weather radar system is described in Chapter 11, Flight Management, Navigation.

## **Traffic**

Traffic information from the TCAS can be displayed on the HSI. TCAS is described in Chapter 15, Warning Systems.

## **Terrain Display**

The HSI can display look ahead terrain alerting. For detailed information, refer to Chapter 15, Warning Systems.

## **Predictive Windshear**

The HSI can display predictive windshear warnings. For detailed information, refer to Chapter 15, Warning Systems.

## **EFIS Failures Flags and Annunciations**

In addition to the normal EFIS displays, various failure annunciations, flags, or indications may be displayed on the ADI or HSI.

The location of the different failure flags and annunciations is depicted in the ADI and HSI Failure Flags and Annunciations figures included in the EFIS Controls and Indicators, section 10 of this chapter.

Not all EFIS displays will be replaced by a failure flag or annunciation if the signal from the sending unit has failed. In these instances, failure is indicated by removal of the data or the affected portions of the display.

During preflight, heading/track data is unavailable until the associated IRS has completed alignment and entered the navigation mode. Heading flags do not appear in this case.

If an FMC FAIL message is observed on a CDU, a MAP flag will appear on the associated HSI when viewing the MAP mode. Selecting the opposite FMC with the NAV selector will restore the map display. If both FMCs fail, selecting CDU on the NAV selector will allow the CDU to provide limited map data to the HSI. For more detailed information on the alternate navigation system, refer to Chapter 11, Flight Management, Navigation.

Various fault messages can also be displayed on the HSIs. For example, a WXR/MAP RANGE DISAGREE message is displayed when the ranges for the FMC and weather radar disagree with the range selected on the HSI control panel.

An EXCESS DATA message is displayed if the quantity of information to the display exceeds the HSI's capability to provide a normal display. If in the MAP mode, deselecting the map switches may correct the condition and remove the message.

---

## **Light Sensing and Brightness Control**

Ambient light sensors automatically adjust the brightness of the EFIS displays. Once the desired brightness is set using the EFIS brightness controls, little or no adjustment is needed throughout a wide range of ambient light conditions both outside and inside the flight deck.



Display range:

- .400 to .999 Mach
- masked below .400 Mach
- flag in view – air data system is inoperative.

**6 Command Airspeed Inoperative Flag**

Flag in view – command airspeed bug is inoperative.

**7 Reference Airspeed Bugs**

Set at reference airspeeds.

**8 Airspeed Indicator and Flag**

- displays airspeed when above 30 knots
- flag in view – air data system is inoperative.

**Primary Altimeter (Electric)**



**1 Altitude Indicator**

Indicates altitude in increments of twenty feet.

OFF flag in view– the altimeter is inoperative

NEG flag in view – displays in the two left-hand windows when altitude below zero feet is displayed.

**2 Altitude Pointer**

Makes one revolution each one thousand feet.

**3 Barometric Setting Control**

Rotate – adjusts barometric settings.



## **2 Wide Bearing Pointer**

- indicates right VOR magnetic bearing to selected station
- maintains last known bearing on loss of right VOR signal
- right ADF portion placarded inoperative.

## **3 Narrow Bearing Pointer**

- indicates left ADF/VOR magnetic bearing to selected station
- maintains last known bearing on loss of left ADF/VOR signal.

## **4 VOR/ADF Selector (Left/Right)**

Rotate – selects related VOR or ADF for the bearing pointer.

## **5 Left/Right DME (DME –L/R) Indicators**

Displays distance to VOR–tuned station (VORTAC or VOR/DME) in nautical miles, except when APP is selected on the associated (L or R) EFIS control panel.

- displays distance to the ILS–tuned station when APP is selected on the associated (L or R) EFIS control panel (L is displayed when valid ILS/DME is available)
- displays dashes when no computed data is available
- displays blank when DME distance is unreliable, or when there are no DME nav aids within range for autotuning

## **6 Compass Card**

Indicates airplane heading under lubber line.

- Captain’s heading information as selected by the first officer’s IRS switch
- First officer’s heading information as selected by the captain’s IRS switch

## **7 Bearing Pointer Failure Flag (Left/Right)**

Selected VOR/ADF receiver has failed, or no computed data is available.

- may be in view with heading flag
- instrument failure.

## Vertical Speed Indicator

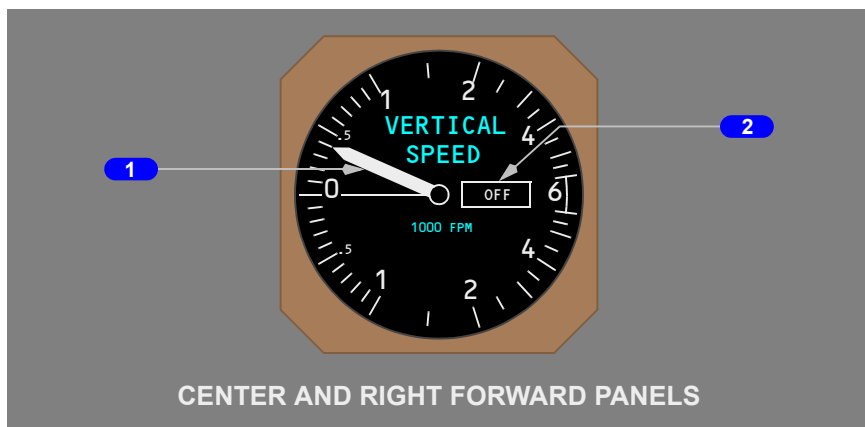

### 1 Vertical Speed Pointer

Indicates rate of climb or descent from 0 to 6,000 feet per minute.

### 2 OFF Flag

Flag in view – VSI is inoperative.

## Clock

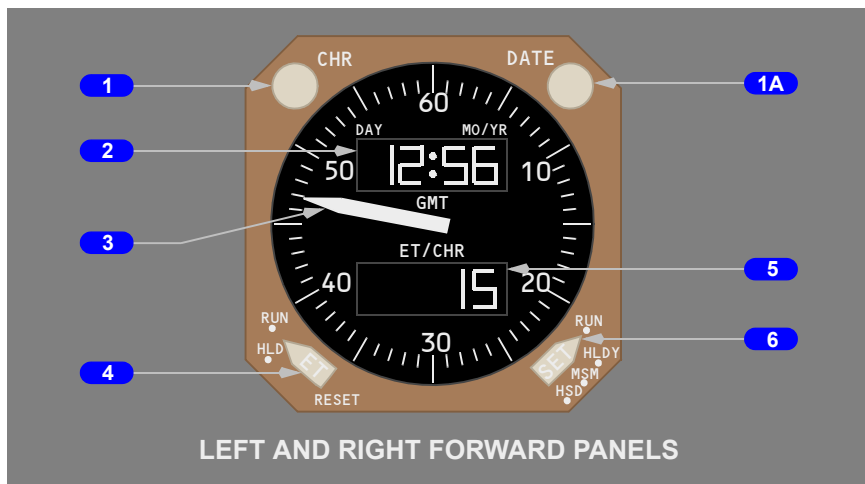

## **1 Chronograph (CHR) Switch**

Push – initiates start, stop and reset functions of the CHR display and second hand  
Subsequent pushes –

- override any existing ET display
- controls chronograph second hand.

### **1A DATE Switch**

Push – displays day and month, alternating with year.  
Subsequent push – returns display to time.

## **2 Time/Date Window**

Displays time (hours, minutes – 24 hour format) when time is selected with the date switch.

Alternately displays day–month and year when date is selected with the date switch.

## **3 Chronograph Second Hand**

Indicates seconds.

## **4 Elapsed Time (ET) Selector**

Controls the elapsed time function.

RUN – starts the elapsed time display.

HLD – stops the elapsed time display.

RESET – (spring-loaded to HLD) returns ET display to zero.

## **5 Elapsed Time/Chronograph (ET/CHR) Window**

Displays elapsed time in hours and minutes, or chronograph minutes.

- when selected, the chronograph display replaces the elapsed time display
- elapsed time continues to run in the background and displays after the chronograph is reset.

## **6 SET Selector**

Sets the time and date when the date switch is set to manual

RUN – starts the time indicator.

HLDY (hold, year) –

- stops the time indicator and sets the seconds to zero when time is selected with the date switch
- advances years when date is selected with the date switch.



MSM (minute slew, month) –

- advances minutes when time is selected with the date switch
- advances months when date is selected with the date switch.

HSD (hour slew, day) –

- advances hours when time is selected with the date switch
- advances days when date is selected with the date switch

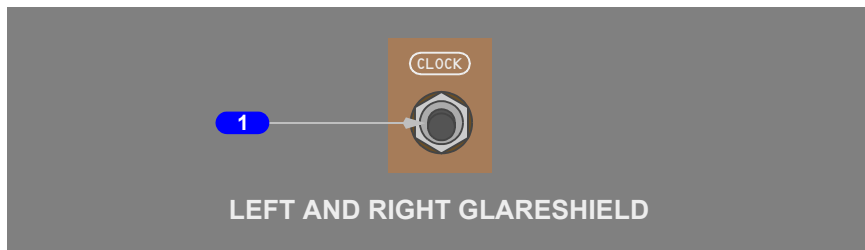

**1 CLOCK Switch**

Operates the same as the chronograph switch.

## Standby Flight Instruments

### Standby Attitude Director Indicator (Standby ADI)

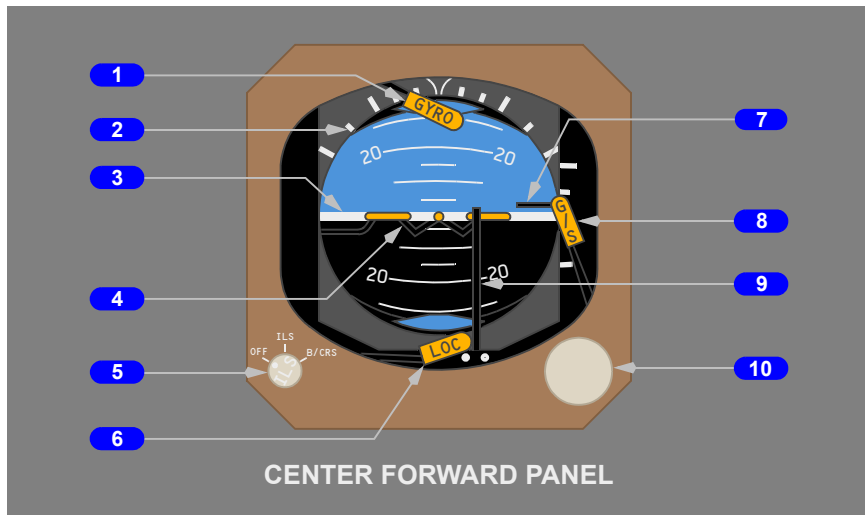

**1 GYRO Flag**

Flag in view – attitude is unreliable.

## **2 Bank Indicator and Scale**

Indicates bank in reference to the bank scale.

## **3 Horizon Line and Pitch Angle Scale**

Indicates horizon relative to the airplane symbol.

Pitch scale is in 5 degree increments.

## **4 Airplane Symbol**

Indicates airplane attitude with reference to the horizon.

## **5 ILS Selector**

OFF – deviation pointers and failure flags retracted from view.

ILS – pointers indicate deviation from localizer and glideslope.

B/CRS – reverses sensing for localizer deviation pointer.

## **6 Localizer (LOC) Flag**

Flag in view – center localizer receiver has failed.

## **7 Glideslope Pointer and Deviation Scale**

The glideslope pointer indicates glideslope position relative to the airplane.

- scale indicates deviation
- pointer is not displayed when ILS selector is OFF or no computed data exists.

## **8 Glideslope (G/S) Flag**

Flag in view – center glideslope receiver has failed.

## **9 Localizer Pointer and Deviation Scale**

The localizer pointer indicates position relative to the airplane.

- scale indicates localizer deviation
- expanded localizer scale not available
- pointer not displayed when ILS selector is OFF or no computed data exists.

## **10 Caging Control**

Pull – aligns horizon with the airplane symbol.

## Standby Airspeed Indicator (Pneumatic)

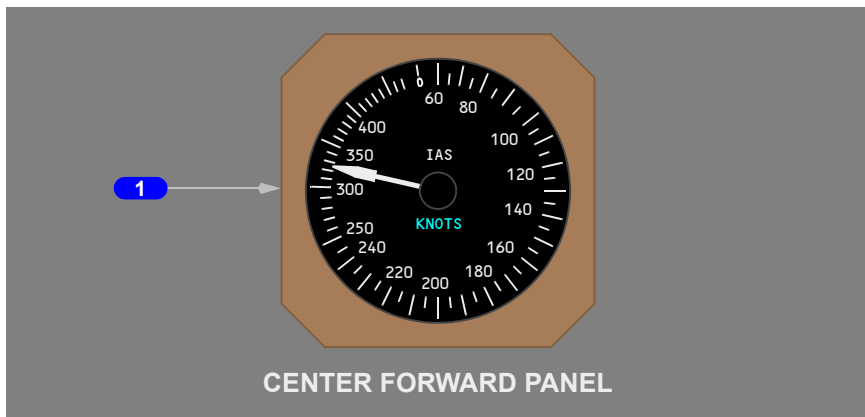

### 1 Standby Airspeed Indicator

Provides alternate airspeed information.

## Standby Altimeter (Pneumatic)

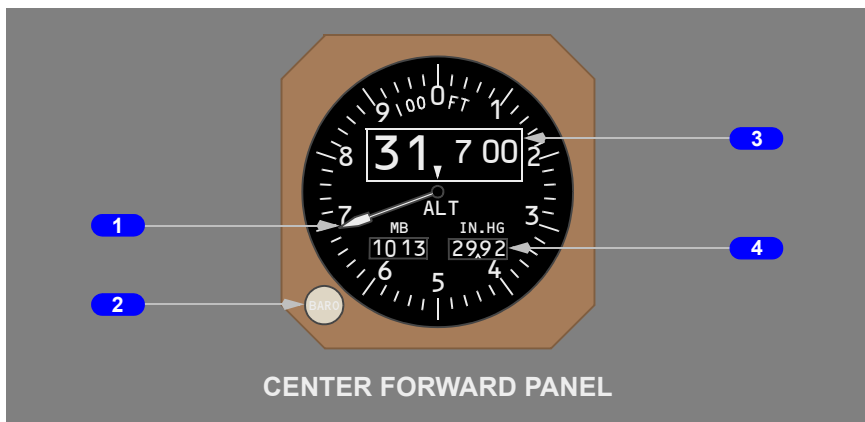

### 1 Altitude Pointer

Makes one revolution each one thousand feet.

### 2 Barometric Setting Control

Rotate – adjusts barometric settings.

### 3 Altitude Indicator

Indicates altitude in increments of twenty feet.

#### 4 Barometric Setting Window

Displays barometric correction (in millibars and inches of mercury) as set by the barometric setting control.

### Standby Magnetic Compass



#### 1 Standby Magnetic Compass

Displays magnetic heading.

### Flight Recorder

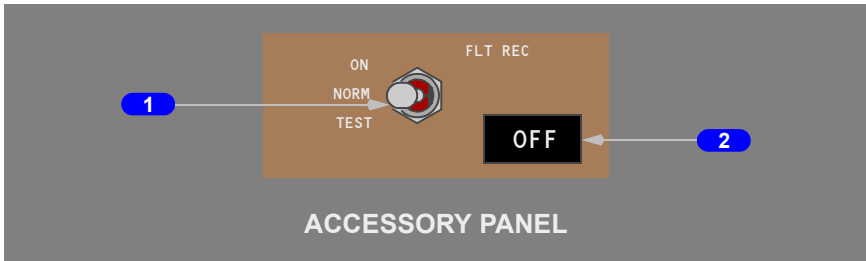

#### 1 Flight Recorder (FLT REC) Switch

ON – applies power to the flight recorder.

NORM –

- in flight – the recorder operates anytime electrical power is available
- on the ground – either engine must also be operating.

TEST – (Spring – loaded to NORM) initiates a flight recorder test.

#### 2 Flight Recorder OFF Light

Illuminated (white) – indicates the recorder is not operating or the test is invalid.

---

**Introduction**

The conventional instruments provide information in addition to the EFIS displays to aid pilots in controlling the airplane throughout its flight regime. This section includes a discussion of the primary instruments, standby instruments, and the pitot static system.

---

**Primary Flight Instruments****Mach/Airspeed Indicator**

Two electric mach/airspeed indicators display airspeed, mach, and V<sub>mo</sub> from the selected air data source. The V<sub>mo</sub> pointer indicates the maximum operating airspeed in knots or the equivalent to the maximum operating mach number. The command airspeed bug on each indicator can be automatically positioned from the FMC, or manually from the MCP IAS/MACH selector.

**Primary Altimeter**

Two electric altimeters indicate current altitude in feet. An altimeter altitude light is provided. Altitude alerting is described in Chapter 15, Warning Systems.

**Radio Distance Magnetic Indicator (RDMI)**

Two radio distance magnetic indicators are installed. Each displays magnetic heading or true heading, VOR or ADF bearing, and (VOR/ILS/DME, VORTAC) distance. The RDMI receives primary heading signals from the opposite side IRS and alternate heading signals from the C-IRS. The RDMI is inoperative until the associated IRS has completed alignment and entered the navigation mode.

With the heading reference switch in NORM, magnetic heading is displayed if the airplane is outside polar regions. In polar regions, a heading flag shows. When the switch is in TRUE, true heading is displayed regardless of latitude. For more information on polar regions refer to Chapter 11, Flight Management, Navigation.

When the RDMI is referenced to true north, positioning an ADF/VOR selector to VOR causes the associated pointer failure flag to appear.

---

## Vertical Speed Indicator

Two electrically-driven vertical speed indicators (VSI) are installed. The captain's VSI is connected to the left IRS and ADC, and the first officer's VSI is connected to the right IRS and ADC. The center IRS provides backup vertical speed data for either crew member when ALTN is selected with the respective IRS switch. The opposite ADC provides backup vertical speed data for either crewmember when ALTN is selected with the respective AIR DATA switch.

The VSI is inoperative until the associated IRS has completed alignment and entered the navigation mode.

## Clock

Two electronic clocks are installed, with two digital displays on each clock. Either coordinated universal time (UTC) or local time may be set on the upper time display. The lower ET/CHR display is used for either elapsed time or the chronograph. Separate controls are provided for each display.

In addition to UTC and local time, the date may be set on the upper time display.

---

## Standby Flight Instruments

### Standby Attitude Director Indicator (Standby ADI)

A self-contained standby attitude director indicator incorporating an ILS display is installed. In the event that all generator power is lost, the standby attitude director indicator will be supplied with electrical power from the standby DC bus. ILS information is provided from the C-ILS receiver.

### Standby Airspeed Indicator (Pneumatic)

The standby airspeed indicator provides current airspeed in knots. It is connected directly to the R AUX PITOT and the alternate static ports. (See pitot-static system schematic.)

### Standby Altimeter (Pneumatic)

A single indicator is installed for standby reference. Input for the indicator is from the alternate static ports. (See pitot-static system schematic.)

### Standby Magnetic Compass

A standard magnetic standby compass is provided. A card located near the compass provides heading correction factors.

## **Flight Recorder**

The flight recorder provides a permanent record of selected operational systems in a sealed, fire-resistant container. The recorder automatically turns on when either engine is operating or the airplane is in flight.

---

## **Air Data System**

The air data system consists of the pitot-static system, one temperature probe (TAT), two angle of attack probes, two air data computers (ADCs), and electric flight instruments. The system provides pitot and/or static pressure information to various flight instruments and airplane systems.

Standby airspeed and altimeter indicators are also provided.

The ADCs use air data information to provide input signals to certain flight instruments (mach/airspeed indicator, primary altimeter) and other using systems (AFDS, FMC, etc.). The left instruments use the left ADC and the right instruments use the right ADC. The opposite ADC is available as an alternate air data source. Warning flags indicate instrument failure or unreliable data. When a malfunction occurs in instruments with failure monitors, warning flags appear.

The EICAS caution messages ALT DISAGREE or IAS DISAGREE display when there is a significant difference between the left and right air data information. These messages are inhibited at low altitude or when both pilots have the same air data source selected.

**Pitot-Static System Schematic (ADCs)**

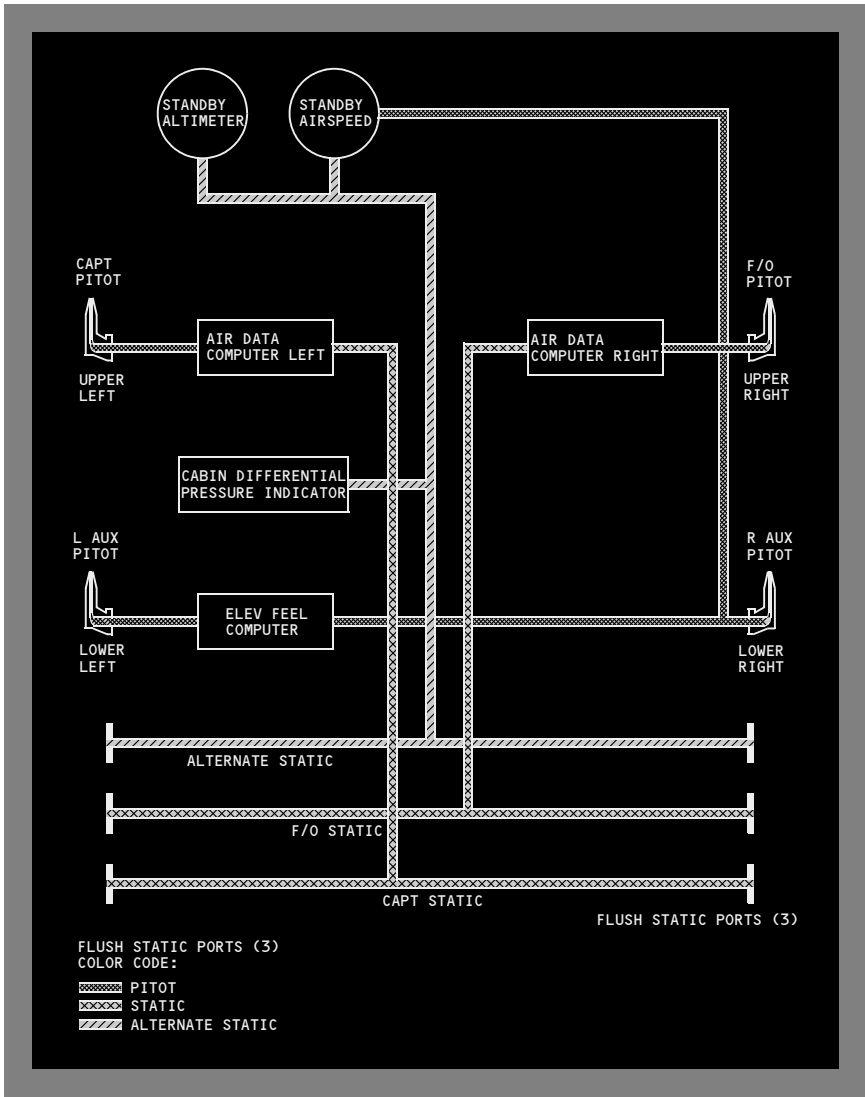

**Total Air Temperature (TAT)**

TAT appears on EICAS above the EPR display and is supplied by a thrust management or air data computer. The TAT indication is comprised of outside air temperature (OAT) plus ram rise. TAT indication on the ground will approximate OAT.



## **True Airspeed/Static Air Temperature (TAS/SAT)**

True airspeed (TAS) and static air temperature (SAT) are displayed on the PROGRESS page.

Intentionally  
Blank

**Flight Instruments, Displays EICAS Messages**

**Note:** The OVERSPEED warning and the ALTITUDE ALERT caution messages are covered in Chapter 15, Warning Systems.

The following EICAS messages can be displayed.

<b>Message</b>	<b>Level</b>	<b>Light</b>	<b>Aural</b>	<b>Condition</b>
ALT DISAGREE	Caution		Beeper	Captain's and first officer's altitude indications disagree.
ATT DISAGREE	Caution		Beeper	Captain's and first officer's attitude indications disagree.
IAS DISAGREE	Caution		Beeper	Captain's and first officer's airspeed indications disagree.
INSTR SWITCH	Caution		Beeper	Both EFI switches are in the ALTN position.

Intentionally  
Blank

**Controls and Indicators . . . . . 11.10**

- Flight Management System . . . . . 11.10.1
  - Control Display Unit (CDU) . . . . . 11.10.1
  - Function and Execute Keys . . . . . 11.10.2
  - Alpha/Numeric and Miscellaneous Keys . . . . . 11.10.4
  - CDU Page Components . . . . . 11.10.5
  - FMC Annunciator Light . . . . . 11.10.6
- Inertial System . . . . . 11.10.7
  - Inertial Reference System . . . . . 11.10.7
- Radio Navigation Systems . . . . . 11.10.10
  - Automatic Direction Finding (ADF) Control . . . . . 11.10.10
  - Transponder Panel . . . . . 11.10.11
  - ILS Control Panel . . . . . 11.10.12
  - VOR Control Panel . . . . . 11.10.13
  - Marker Beacon Lights . . . . . 11.10.14
- Weather Radar . . . . . 11.10.15
  - Weather Radar Panel . . . . . 11.10.15
  - Weather Radar Switch . . . . . 11.10.17

**Navigation Systems Description . . . . . 11.20**

- Introduction . . . . . 11.20.1
- Navigation Systems Flight Instrument Displays . . . . . 11.20.1
- Inertial Reference System . . . . . 11.20.1
  - Inertial Reference System Operation . . . . . 11.20.1
  - IRS Alignment . . . . . 11.20.1
  - IRS Attitude . . . . . 11.20.3
  - IRS Power . . . . . 11.20.3
- Radio Navigation Systems . . . . . 11.20.3
  - Automatic Direction Finding (ADF) . . . . . 11.20.3
  - Distance Measuring Equipment (DME) . . . . . 11.20.3
  - VOR . . . . . 11.20.4
  - Marker Beacon . . . . . 11.20.5

---

Multi-Mode Receiver . . . . .	11.20.5
Instrument Landing System (ILS). . . . .	11.20.5
Global Positioning System (GPS) . . . . .	11.20.5
GPS Displays . . . . .	11.20.5
GPS Data . . . . .	11.20.5
GPS System Schematic . . . . .	11.20.6
Transponder . . . . .	11.20.7
Weather Radar . . . . .	11.20.7
<b>Flight Management System Description . . . . .</b>	<b>11.30</b>
Introduction . . . . .	11.30.1
Flight Management Computer (FMC) . . . . .	11.30.1
Control Display Units (CDUs) . . . . .	11.30.2
<b>Flight Management System Operation . . . . .</b>	<b>11.31</b>
Introduction . . . . .	11.31.1
Preflight . . . . .	11.31.1
Takeoff . . . . .	11.31.2
Climb . . . . .	11.31.2
Cruise . . . . .	11.31.2
Descent . . . . .	11.31.2
Approach . . . . .	11.31.2
Flight Complete . . . . .	11.31.2
Operational Notes . . . . .	11.31.2
Terminology . . . . .	11.31.3
Navigation Position . . . . .	11.31.4
FMC Position Update . . . . .	11.31.5
FMC Polar Operations . . . . .	11.31.6
Navigation Performance . . . . .	11.31.7
Lateral Navigation (LNAV) . . . . .	11.31.8
Waypoints . . . . .	11.31.8
Engine Out SID . . . . .	11.31.14
HSI Map Displays . . . . .	11.31.15

---

Vertical Navigation (VNAV) . . . . .	11.31.15
Speed/Altitude Constraints . . . . .	11.31.15
Takeoff and Climb . . . . .	11.31.17
Cruise . . . . .	11.31.19
Mode Control Panel Speed Intervention . . . . .	11.31.20
Descent . . . . .	11.31.20
Approach . . . . .	11.31.25
Missed Approach . . . . .	11.31.26
Cruise and Descent Profile (Nonprecision Approach) . . . . .	11.31.27
VNAV Engine Out Operation . . . . .	11.31.29
Data Entry Rules . . . . .	11.31.31
Altitude Entry . . . . .	11.31.31
Airspeed Entry . . . . .	11.31.32
Data Pairs . . . . .	11.31.32
<b>Flight Management Computer . . . . .</b>	<b>11.32</b>
FMC Databases . . . . .	11.32.1
Thrust Management . . . . .	11.32.1
Fuel Monitoring . . . . .	11.32.2
Loss of FMC Electrical Power . . . . .	11.32.3
FMC Failure . . . . .	11.32.3
Single FMC Failure . . . . .	11.32.3
Dual FMC Failure . . . . .	11.32.3
FMC Resets . . . . .	11.32.4
<b>FMC Preflight . . . . .</b>	<b>11.40</b>
Introduction . . . . .	11.40.1
Preflight Page Sequence . . . . .	11.40.1
Minimum Preflight Sequence . . . . .	11.40.2
Supplementary Pages . . . . .	11.40.2
Preflight Pages – Part 1 . . . . .	11.40.3
Initialization/Reference Index Page . . . . .	11.40.3
Identification Page . . . . .	11.40.5
Position Initialization Page . . . . .	11.40.7

---

Position Reference Pages .....	11.40.10
Route Page .....	11.40.16
Preflight Pages – Part 2 .....	11.40.22
Departure/Arrival Index Page .....	11.40.22
Departures Page .....	11.40.23
Navigation Radio Page .....	11.40.26
Performance Initialization Page .....	11.40.27
Takeoff Reference Page .....	11.40.29
Menu Page .....	11.40.32
<b>FMC Takeoff and Climb .....</b>	<b>11.41</b>
Introduction .....	11.41.1
Takeoff Phase .....	11.41.1
Climb Phase .....	11.41.1
Climb Page .....	11.41.2
Engine Out Climb .....	11.41.5
Route Legs Page .....	11.41.6
Engine Out Departure .....	11.41.10
Air Turn–Back .....	11.41.10
Arrivals Page .....	11.41.10
<b>FMC Cruise .....</b>	<b>11.42</b>
Introduction .....	11.42.1
LNAV Modifications .....	11.42.1
RTE LEGS Page Modifications .....	11.42.1
Add Waypoints .....	11.42.2
Delete Waypoints .....	11.42.3
Change Waypoint Sequence .....	11.42.4
Remove Discontinuities .....	11.42.5
Direct To And Intercept Course To .....	11.42.7
Intercept Course From .....	11.42.8
SELECT DESIRED Waypoint (WPT) Page .....	11.42.11
Airway Intercept .....	11.42.13
Route Offset .....	11.42.15



---

Cruise Page . . . . .	11.42.16
All Engine Cruise . . . . .	11.42.16
Engine Out Cruise . . . . .	11.42.19
VNAV Modifications . . . . .	11.42.21
Cruise Climb. . . . .	11.42.21
Planned Step Climb . . . . .	11.42.22
Calculated Step Climb . . . . .	11.42.22
Cruise Descent . . . . .	11.42.25
Early Descent . . . . .	11.42.25
Navigation Data . . . . .	11.42.26
Reference Navigation Data Page . . . . .	11.42.26
Fix Information Page . . . . .	11.42.29
In-Flight Position Update . . . . .	11.42.31
Route and Waypoint Data . . . . .	11.42.32
Route Data Page . . . . .	11.42.32
Wind Data. . . . .	11.42.33
Wind Page. . . . .	11.42.34
Progress Pages . . . . .	11.42.36
Progress Page 1 . . . . .	11.42.36
Progress Page 2. . . . .	11.42.39
Position Report Page . . . . .	11.42.41
<b>FMC Descent and Approach . . . . .</b>	<b>11.43</b>
Introduction . . . . .	11.43.1
Early Descent . . . . .	11.43.1
Descent. . . . .	11.43.1
Descent Page. . . . .	11.43.1
Descent Forecast Page . . . . .	11.43.4
Offpath Descent Page . . . . .	11.43.6
Engine Out Descent . . . . .	11.43.8
Approach . . . . .	11.43.8
Arrivals Page – IFR Approaches . . . . .	11.43.8
Vertical Angle Display on the Route Legs Page . . . . .	11.43.10
Arrivals Page – VFR Approaches . . . . .	11.43.11

---

Approach Reference Page . . . . .	11.43.13
Alternate Airport Diversions . . . . .	11.43.15
Alternate Page . . . . .	11.43.15
XXXX Alternate Page . . . . .	11.43.18
Holding . . . . .	11.43.21
Hold Page (First Hold) . . . . .	11.43.22
Hold Page (Existing Hold) . . . . .	11.43.25
<b>FMS Alternate Navigation System Description . . . . .</b>	<b>11.50</b>
Introduction . . . . .	11.50.1
Alternate Navigation Waypoints . . . . .	11.50.1
Alternate Lateral Navigation . . . . .	11.50.1
Route Changes . . . . .	11.50.2
Course Reference . . . . .	11.50.2
Alternate Navigation CDU Pages . . . . .	11.50.2
Alternate Navigation Legs Page . . . . .	11.50.3
Alternate Navigation Progress Page . . . . .	11.50.4
<b>EICAS Messages . . . . .</b>	<b>11.60</b>
EICAS and CDU Messages . . . . .	11.60.1
FMC Messages . . . . .	11.60.2
FMC Alerting Messages . . . . .	11.60.2
FMC Advisory Messages . . . . .	11.60.4
CDU Annunciator Lights . . . . .	11.60.5

**Flight Management System**

**Control Display Unit (CDU)**

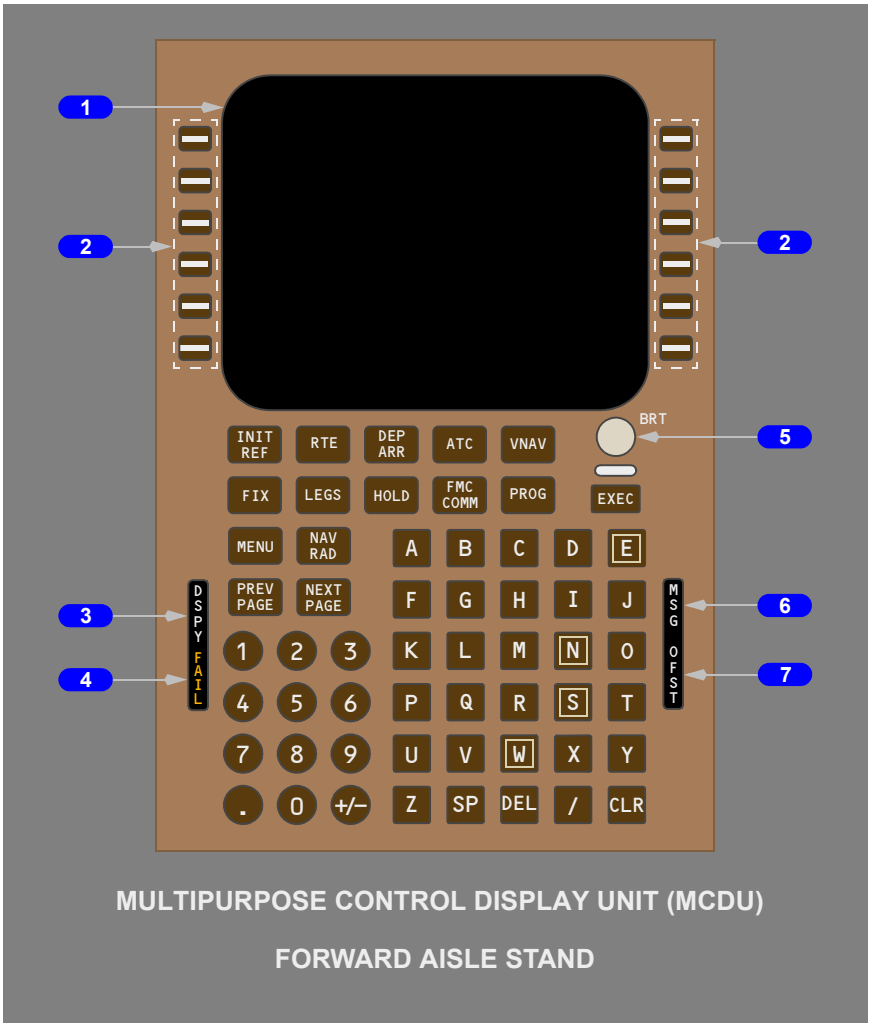

**MULTIPURPOSE CONTROL DISPLAY UNIT (MCDU)  
FORWARD AISLE STAND**

**1 Control Display Unit (CDU) Display**

Displays FMS data pages.

**2 Line Select Keys**

Push –

- moves data from scratchpad to selected line
- moves data from selected line to scratchpad
- selects page, procedure, or performance mode as applicable
- deletes data from selected line when DELETE is displayed in scratchpad.

**3 Display (DSPY) Light**

Illuminated (white) –

- when RTE page 3 or greater, RTE LEGS page 2 or greater, RTE DATA page 2 or greater is displayed
- when airplane is not in holding pattern displayed on HOLD page
- when modification is in progress, and any RTE, RTE LEGS, RTE DATA, HOLD, or VNAV page is displayed.

**4 FAIL Light**

Illuminated (amber) – fault detected in related FMC.

**5 Brightness Control**

Rotate – controls display brightness.

**6 Message (MSG) Light**

Illuminated (white) – scratchpad message is displayed.

**7 Offset (OFST) Light**

Illuminated (white) – LNAV gives guidance for lateral route offset.

**Function and Execute Keys**

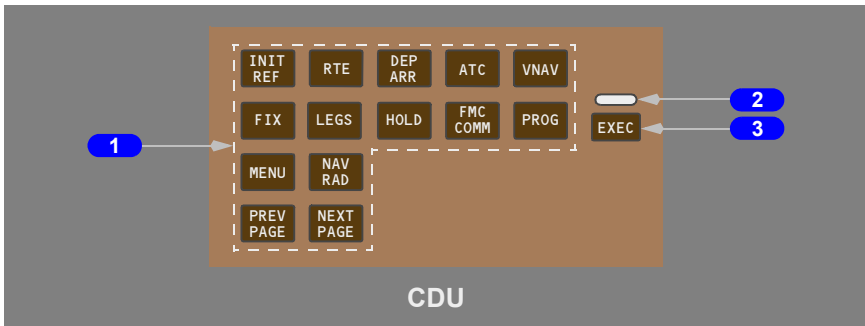

## **1** CDU Function Keys

Push –

- INIT REF – displays page for data initialization or for reference data
- RTE – displays page to input or change origin, destination, or route
- DEP ARR – displays page to input or change departure and arrival procedures
- ATC – displays ATC datalink pages (function inoperative)
- VNAV – displays page to view or change vertical navigation path data
- FIX – displays page to create reference points on HSI map
- LEGS –
  - displays page to evaluate or modify lateral and vertical route data
  - displays page to control HSI PLAN mode display
- HOLD – displays page to create holding patterns and show holding pattern data
- FMC COMM – displays FMC data link status page (function inoperative)
- PROG – displays page to view dynamic flight and navigation data, including waypoint and destination ETAs, fuel remaining, and arrival estimates
- MENU – displays page to choose subsystems controlled by CDU
- NAV RAD – displays page to monitor or control VOR tuning
- PREV PAGE – displays previous page of related pages (for example, LEGS pages)
- NEXT PAGE – displays next page of related pages.

## **2** Execute Light

Illuminated (white) – active data is modified but not executed.

## **3** Execute (EXEC) Key

Push –

- makes data modification(s) active
- extinguishes execute light.

## Alpha/Numeric and Miscellaneous Keys

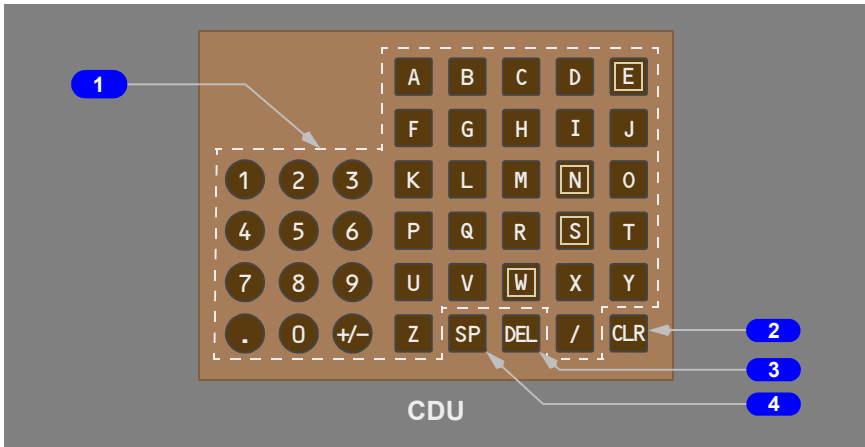

### 1 Alpha/Numeric Keys

Push –

- puts selected character in scratchpad
- Slash (/) key – puts "/" in scratchpad
- Plus Minus (+/-) key – first push puts "-" in scratchpad. Subsequent pushes alternate between "+" and "-".

### 2 Clear (CLR) Key

Push –

- clears last scratchpad character
- clears scratchpad message.

Push and hold – clears all scratchpad data.

### 3 Delete (DEL) Key

Push – puts "DELETE" in scratchpad.

### 4 Space (SP) Key

Push –

- puts space in scratchpad

**Note:** The SP key is normally used when keying in messages for datalink communications. If the SP key is inadvertently pressed while keying in data for FMC use, it will result in an INVALID ENTRY scratchpad message when attempting to select the data to the appropriate line. Should this occur, clear the scratchpad and begin again.

## CDU Page Components



### 1 Page Title

Subject or name of data displayed on page.

ACT (active) or MOD (modified) shows whether page contains active or modified data.

### 2 Line Title

Title of data on line below.

### 3 Line Data

Displays –

- data
- entry field
- prompts

### 4 Prompts

Caret "<" or ">" indicates a prompt.

Push – selects indicated information, mode, or page.

### 5 Page Number

Left number is page number. Right number is total number of related pages. Page number is blank when only one page exists.

**6 Boxes**

Data input is mandatory.

**7 Dashes**

Data input is optional. The data is not mandatory.

**8 Scratchpad**

Displays messages, alphanumeric entries or line selected data.

## FMC Annunciator Light

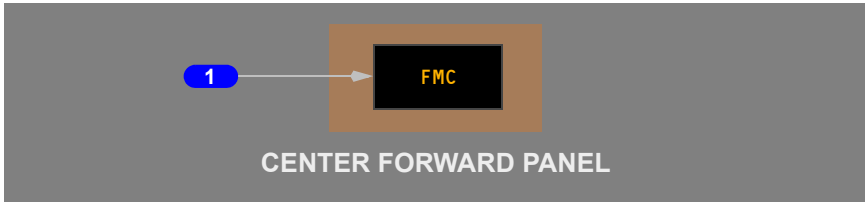

**1 FMC Annunciator Light**

Illuminated (amber) –

- CDU is displaying an operationally significant message in the scratchpad
- pushing CDU CLR key extinguishes the light and clears the scratchpad message



## Inertial System

### Inertial Reference System

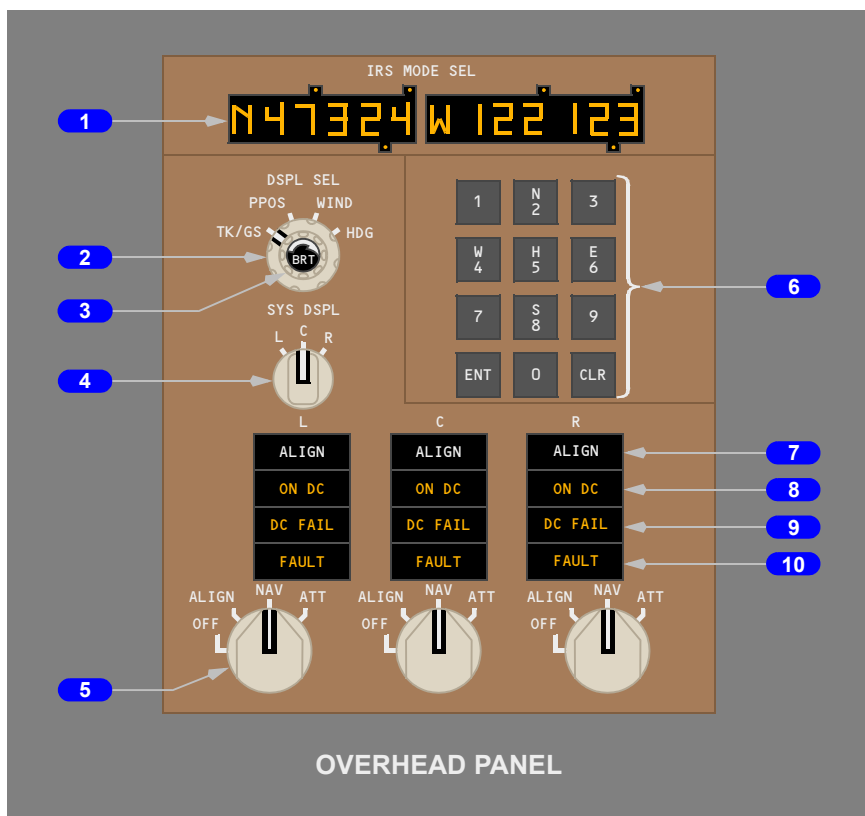

#### 1 IRS DISPLAY

Displays track, groundspeed, present position, wind or heading as controlled by display selectors or keyboard.

#### 2 IRS Display Selector

Selects data for display when keyboard not in control.

- TK/GS – displays present true track and groundspeed
- PPOS – displays present position
- WIND – displays present true wind when in-flight
- HDG – displays present true heading.

### **3 Brightness Control**

Rotate – controls display brightness.

### **4 IRS System Display Selector**

Selects system to display data when keyboard not in control.

### **5 IRS Mode Selectors**

Rotate – controls mode of related IRS.

Must be pulled out to move from NAV position.

OFF –

- alignment is lost
- ALIGN light illuminates for 30 seconds as system goes through a shutdown sequence
- realignment requires about 10 minutes parking and present position (latitude and longitude) entry.

ALIGN –

- initiates alignment when parked
- initiates a quick alignment if selected when the system is in the navigation mode.

NAV –

- normal operational mode
- permits system to enter NAV mode after completing alignment
- initiates a 10 minute alignment if selected from OFF.

ATT –

- provides only attitude and heading information
- position and ground speed information lost until system realigned on ground
- when selected airborne, ALIGN light illuminates for 30 seconds while system senses local level (requires level flight)
- magnetic heading input required to initialize heading output
- the selector must be cycled through OFF to re-enter ALIGN or NAV mode.

### **6 IRS Keyboard**

Push an alpha key to begin entry.

- pushing the N, S, E or W keys changes the IRS display to keyboard control and arms the keyboard for latitude or longitude entry
- pushing H changes the display to keyboard control and arms the keyboard for heading entry.

Enter (ENT) Key – push

- enters data from display into all three IRS systems
- restores display to the display selector setting

Clear (CLR) Key – push

- clears data keyed into display
- restores display to the display selector setting.

## **7** ALIGN Lights

Illuminated (white) –

- steady – the related IRS is operating in the ALIGN mode, the initial ATT mode, or the shutdown cycle
- flashing – alignment cannot be completed due to IRS detection of:
  - significant difference between previous and entered positions or an unreasonable present position entry.
  - no present position entry.

Extinguished –

- IRS not in ALIGN mode
- with mode selector in NAV, alignment is complete, and all IRS information is available
- with mode selector in ATT, attitude information is available. Heading information is available following entry of initial magnetic heading.

## **8** ON DC Lights

Illuminated (amber) –

- normal AC power for the related IRS has failed and the IRS is operating on DC backup power from the hot battery bus (AC power not normal)
- if on the ground, the ground-call horn in the nose wheel well sounds, providing an alert that a battery drain condition exists
- EICAS advisory message L, C or R IRS ON DC is displayed
- momentary illumination is normal during alignment self-test.

## **9** DC FAIL Lights

Illuminated (amber) –

- DC backup power for the related IRS has failed
- if the other lights are extinguished, the IRS is operating normally on AC power.
- EICAS advisory message L, C or R IRS DC FAIL is displayed

## 10 FAULT Lights

Illuminated (amber) – a system fault affecting the related IRS ATT and/or NAV modes has been detected. The EICAS advisory message L, C or R IRS FAULT is also displayed.

## Radio Navigation Systems

### Automatic Direction Finding (ADF) Control

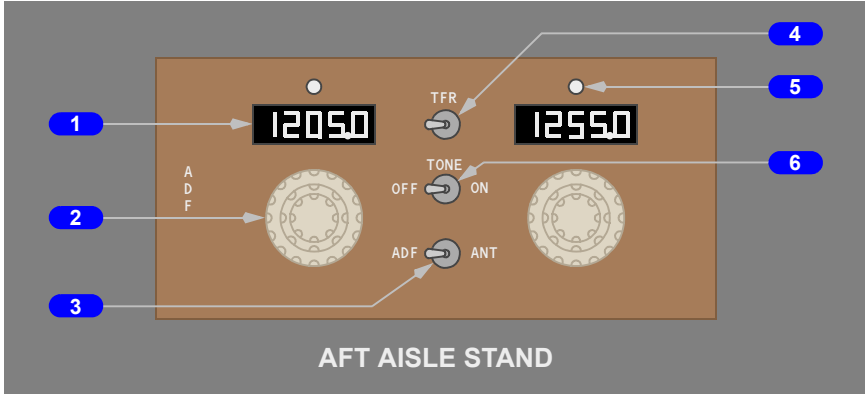

#### 1 Frequency Indicators

Display the frequency selected with the related frequency selector.

#### 2 Frequency Selectors

Rotate –

- outer knob sets the hundreds number
- middle knob sets the tens number
- inner knob sets the tenths and ones number.

#### 3 Mode Selector

ADF –

- audio reception possible
- ADF bearing data provided.

ANT –

- audio reception optimized
- no ADF bearing data provided.

#### 4 Transfer (TFR) Switch

Selects which frequency selector controls the ADF.

#### 5 ADF Transfer Lights

Illuminate to indicate which frequency is tuned.

#### 6 TONE Switch

ON – activates tone generator required for receiving audio from unmodulated stations.

OFF – deactivates tone generator.

### Transponder Panel

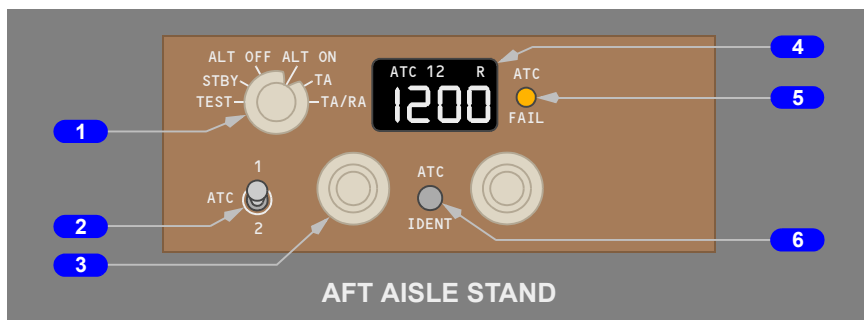

#### 1 TCAS Mode Selector

TEST – activates test.

STBY – deactivates transponder.

ALT OFF – activates transponder without altitude reporting if airplane is in-flight.

ALT ON – activates transponder with altitude reporting if airplane is in-flight.

TA (traffic advisory) – activates TCAS Traffic Advisory (TA) mode and altitude reporting. (refer to Chapter 15, Warning Systems)

TA/RA – activates TCAS TA and Resolution Advisory (RA) modes. (refer to Chapter 15, Warning Systems)

#### 2 Transponder Selector

1 – selects number 1 transponder for operation.

2 – selects number 2 transponder for operation.

### 3 Transponder Code Selectors

Sets transponder code in transponder code window and both transponders. Left selector sets the first two digits, the right selector sets the second two digits.

### 4 Transponder Code Window

Displays transponder code. The heading shows which transponder is selected (ATC 1 or 2) and when a reply is being sent (R).

### 5 ATC FAIL Light

Illuminated (amber) – selected transponder has failed.

### 6 Identification (IDENT) Switch

Push – transmits an identification signal.

## ILS Control Panel

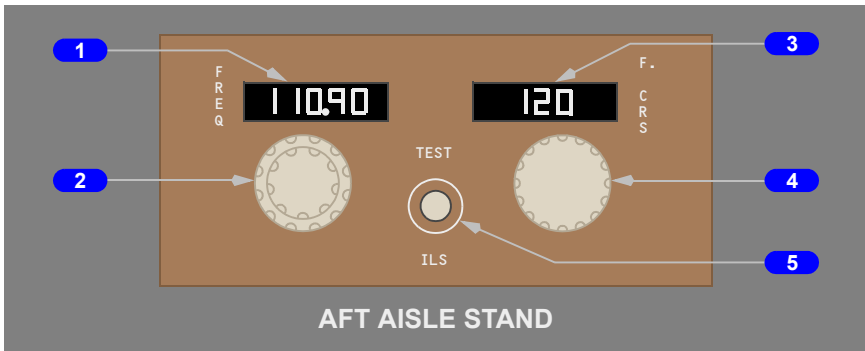

### 1 ILS Frequency (FREQ) Indicator

Displays frequency tuned in all three ILS receivers.

Displays dashes (----) if the selector is in the standby position. The display is generated by the center ILS receiver.

### 2 ILS Frequency Selector

Rotate – tunes all ILS receivers.

- tuned frequency displayed in frequency window
- received data is displayed on the ADI
- if selected, ILS data is displayed on the related HSI and the associated DME is tuned to the ILS frequency
- VOR frequencies cannot be tuned

**757 Flight Crew Operations Manual**

- frequency change is inhibited when all three autopilots are armed and either localizer or glideslope is captured
- dashes are displayed when turned to the standby position. ILS display symbology is removed from the ADI when dashes are displayed.

**3 ILS Front Course (F. CRS) Indicator**

Displays the selected front course.

**4 ILS Front Course Selector**

Rotate – selects the ILS front course.

**5 ILS Test Switch**

Push – sends a test signal to all ILS receivers except during multiple autopilot approaches after either localizer or glideslope capture.

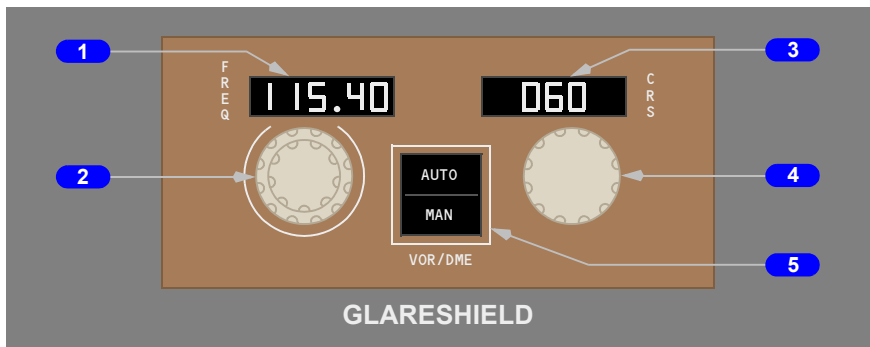
**VOR Control Panel****1 VOR Frequency (FREQ) Indicator**

Indicates the frequency selected by the frequency selector.

**2 VOR Frequency Selector**

Rotate –

- when MAN light illuminated, tunes related VOR and also tunes DME if HSI mode selector is not in an ILS position
- ILS frequencies cannot be tuned.

**3 VOR Course (CRS) Indicator**

Displays course set by VOR course selector.

#### 4 VOR Course Selector

Rotate – sets course in VOR course window and EFIS.

#### 5 VOR/DME Switch

Push –

- alternates VOR and DME tuning between the FMC automatic (AUTO) and VOR frequency selector manual (MAN) when the HSI mode selector is in MAP or PLAN.
- only MAN is available when the HSI is not in a MAP or PLAN mode.

AUTO light illuminated (white) –

- FMC is tuning related VOR and DME
- HSI Selector must be in a MAP or PLAN position.

MAN light illuminated (white) –

- VOR frequency selector is tuning VOR
- VOR frequency selector also tunes the DME if the HSI is not selected to an ILS display
- if the HSI is selected to an ILS display, the ILS frequency selector tunes the DME.

### Marker Beacon Lights

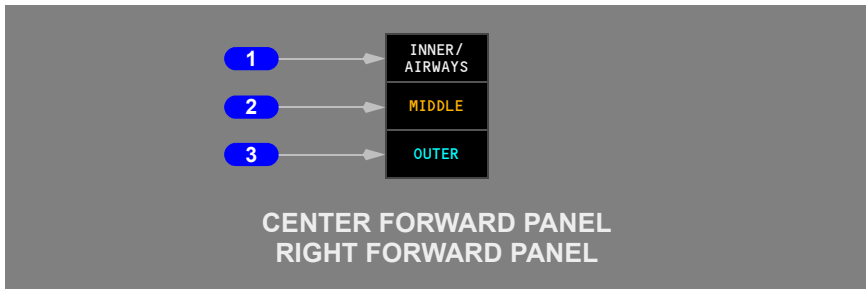

#### 1 INNER/AIRWAYS Marker Beacon Light

Illuminated (white) – over an inner or airways marker beacon.

#### 2 MIDDLE Marker Beacon Light

Illuminated (amber) – over a middle marker beacon.

#### 3 OUTER Marker Beacon Light

Illuminated (blue) – over an outer marker beacon.



## Weather Radar

### Weather Radar Panel

[Basic: Weather radar single R/T.]

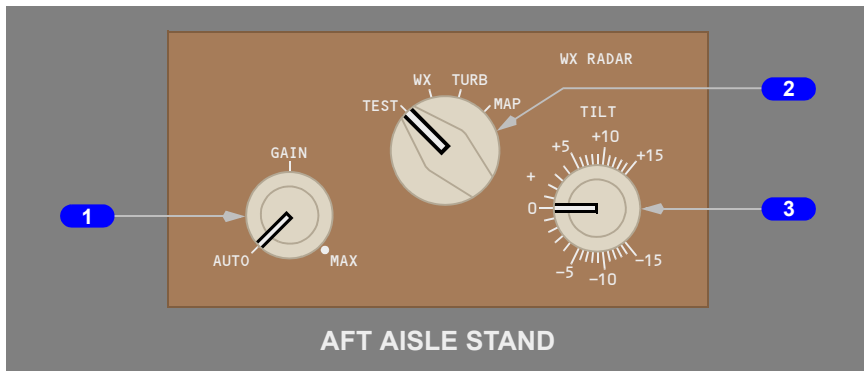

#### 1 GAIN Control

AUTO – normal operation, detent position provides automatic gain control calibrated for optimum return.

Rotate – provides manual control of radar gain. Gain increases as control is rotated clockwise toward MAX.

#### 2 Mode Selector

TEST – activates system test.

WX – displays weather radar returns at selected gain level.

TURB – displays weather radar returns plus turbulence. Turbulence is only shown on display ranges of 40 miles or less.

MAP – displays ground returns.

#### 3 TILT Control

Rotate clockwise – radar antenna tilts up to selected degrees from horizon.

Rotate counterclockwise – radar antenna tilts down to selected degrees from horizon.

[Option: Weather radar dual R/T.]

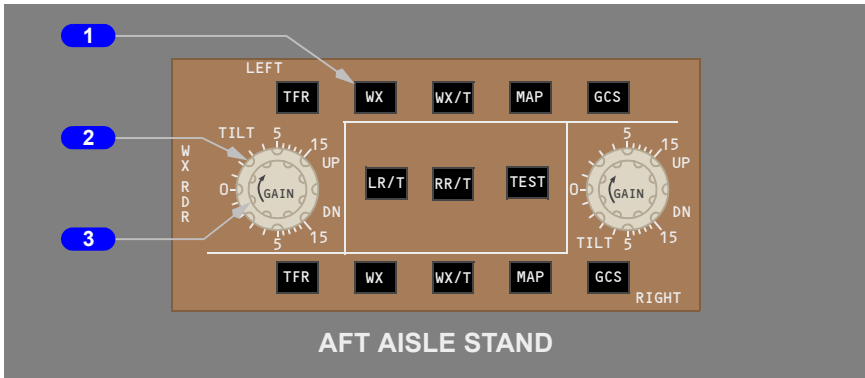

## 1 Mode Switches

The LEFT controls affect the captain's radar display and the RIGHT controls affect the first officer's display.

TFR – transfers control of the respective display to selections made on the opposite controls.

WX – displays weather radar returns at selected gain level.

WX/T – displays weather radar returns plus turbulence. Turbulence is only shown on display ranges of 40 miles or less.

MAP – displays ground returns at selected gain level.

GCS – activates ground clutter suppression mode.

- IN – ground clutter suppression active (reduces amount of ground returns)
- OUT – ground clutter suppression off

**Note:** Continuous operation is not recommended as weather return intensity may be reduced.

LR/T – selects left system for operation when radar is on.

RR/T – selects right system for operation when radar is on.

TEST – displays maintenance test pattern.

## 2 TILT Controls

Rotate clockwise – radar antenna tilts up to selected degrees from horizon.

Rotate counterclockwise – radar antenna tilts down to selected degrees from horizon.

### **3 GAIN Controls**

Rotate – provides manual control of radar gain to enhance returns in weather and ground mapping modes. The twelve o'clock detent sets receiver sensitivity at a preset calibrated level.

## **Weather Radar Switch**

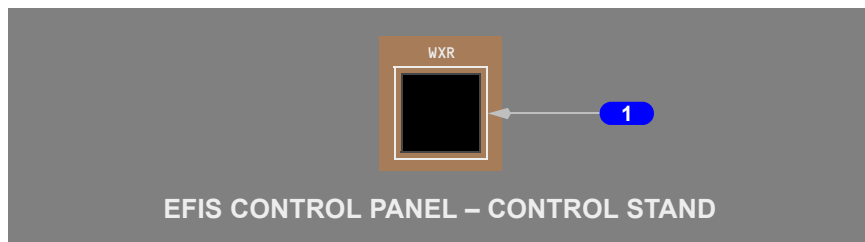

### **1 Weather Radar (WXR) Switch**

Push – alternately selects the HSI radar display on and off. The radar transmitter is activated when the radar is displayed on either HSI.

Intentionally  
Blank

---

## **Introduction**

Navigation systems include the global positioning system (GPS), inertial reference system (IRS), VOR, DME, ILS, ADF, ATC transponder, weather radar, and the flight management system (FMS). The FMS is described in the Flight Management System Description section of this chapter.

The FMC will provide navigation guidance and MAP display between 87° North and 87° South latitudes.

---

## **Navigation Systems Flight Instrument Displays**

Refer to Chapter 10, Flight Instruments, Displays for flight instrument display system operations and typical instrument displays.

---

## **Inertial Reference System**

The inertial reference system (IRS) calculates airplane position, acceleration, track, vertical speed, ground speed, true and magnetic heading, wind speed and direction. It also supplies attitude data for the displays, flight management system, flight controls, engine controls, and other systems.

The IRS consists of three Inertial Reference Units (IRUs) and the IRS mode selector panel.

## **Inertial Reference System Operation**

The Inertial Reference System is controlled by the IRS Mode Control Panel on the overhead panel. When operating in the navigation mode, the IRS provides attitude, acceleration, ground speed, track, true and magnetic heading, present latitude and longitude, and wind speed and direction to other systems. In normal operation, the FMC is used to input data to the IRS and to monitor system operation.

Magnetic heading and track are not available in polar regions. Magnetic reference is provided between N73° and S60° latitude. Above these latitudes only true headings are available.

## **IRS Alignment**

An IRS must be aligned before it can enter the NAV mode. Rotating the IRS mode selector from OFF to NAV begins the IRS alignment. The IRS performs a short power test, during which the ON DC light illuminates. When the ON DC light extinguishes the ALIGN light illuminates. Alignment requires approximately ten minutes.

Present position (latitude and longitude) must be entered on the CDU position initialization page to complete the alignment. If the present position cannot be entered through the CDU, it may be entered through the IRS mode selector keyboard.

If the latitude/longitude position is not near the origin airport, the CDU scratchpad message VERIFY POSITION is displayed. If the entered latitude/longitude position does not pass the IRS internal comparison tests, the scratchpad message ENTER IRS POSITION is displayed.

Alignment can be accomplished only when the airplane is parked. Alignment stops if an IRU detects motion during alignment. When the motion stops, some units restart the alignment automatically. Other units flash the ALIGN lights until the alignment is manually restarted.

The IRS is aligned when all IRUs enter the navigation mode. The latitude and longitude display on the SET IRS POS line of the CDU POS INIT page then blanks. Alignment is lost if the selector is moved out of the NAV position.

### **High Latitude Alignment**

High latitude (between 70° 12.0' and 78° 15.0') alignments requires an extended alignment time. This extended alignment is accomplished by rotating the Mode Selector from OFF to the ALIGN position and allowing the IRS to align for a minimum of 17 minutes. Present position is entered while in the align mode. After the extended alignment, navigation mode is entered by rotating the mode selector to the NAV position.

### **Fast Realignment**

Following operation in the navigation mode and with the airplane parked, performing a fast realignment removes accumulated track, ground speed, and attitude errors, levels the system, and updates present position. This is accomplished by positioning selectors to ALIGN, entering present position, and repositioning selectors to NAV. Fast realignment completes in approximately 30 seconds.

Fast realignment can be accomplished without entering present position. However, greater navigational accuracy is attained by entering present position.

A full alignment must be accomplished when the time from the last full alignment to the completion of the next flight exceeds 18 hours.

## **IRS Attitude**

If alignment is lost in flight, the navigation mode is inoperative for the remainder of the flight. Attitude information can be obtained by moving the selector to ATT. The IRU enters the Align mode for 30 seconds during which the airplane should stay in straight and level flight. This re-levels the system and provides attitude displays on the ADI. Some attitude errors may occur during acceleration. After acceleration, errors are slowly removed.

Heading information can be provided in the ATT Mode if a heading entry is made on the CDU POS INIT page or IRS mode selector panel. Magnetic heading must be updated periodically.

## **IRS Power**

Normally the IRSs operate on AC power from the left and right electrical systems. The main airplane battery is used as an alternate power source. The ON DC light illuminates and the EICAS message IRS ON DC is displayed when AC power is lost and DC power is being used. The DC FAIL light illuminates and the EICAS message IRS DC FAIL is displayed when DC power is lost and AC power is being used. Both lights extinguish if both AC and DC power are on or off.

If all AC power sources are lost the IRSs are powered by the Standby power system.

Standby power to the right IRS is limited to 5 minutes to save battery power.

---

## **Radio Navigation Systems**

### **Automatic Direction Finding (ADF)**

A single ADF system is installed with the control panel.

ADF bearings can be selected for display on the RDMIs.

### **Distance Measuring Equipment (DME).**

Two DME systems are installed and each can be automatically tuned by the FMC or manually tuned by the VOR or ILS control panel.

#### **DME Tuning**

When an ILS or VOR mode is displayed on the HSI, the related ILS or VOR control panel tunes the DME.

When the HSI selector is in a MAP or PLAN position automatic FMC tuning or manual VOR panel tuning can be selected with the MAN/AUTO switch on the VOR control panel.

The DME can also be remotely tuned on the CDU by entering a VOR frequency or identifier on the NAV RADIO page.

The FMC uses two DMEs for position updates. If only one DME is available the FMC can use that DME and the associated VOR for a VOR/DME update.

The NAVAID INHIBIT function on the REF NAV DATA page prevents the FMC from tuning navaids which have been entered by the flight crew.

When either or both VORs are being auto tuned by the FMCs the DME receivers are scanned through several frequencies. This provides the FMC with continuous DME–DME updating even when one VOR is being manually tuned or when both VORs are remotely tuned. If both VORs are manually tuned the scanning DME function is disabled.

### **DME Displays**

DME distance is displayed on the RDMI. When the DME is tuned by the ILS receiver the distance display is preceded by an L. DME distance is also displayed on the HSI when operating in the VOR or ILS mode.

POS REF page 2/4 displays the identifiers of the DME stations used for FMC position updates. The identifiers and associated VOR or ILS frequencies are also displayed on the NAV RADIO page.

### **VOR**

There are two VOR receivers and two control panels installed. The VORs are normally tuned by the FMC, but can be tuned manually.

### **VOR Tuning**

In normal operation the FMC tunes both VORs and the associated DMEs for radio position updates. The HSI must be in a MAP or Plan mode to allow FMC tuning of the VOR. Specific VOR/DME navaids can be inhibited on the REF NAV DATA page to prevent the FMC from using those navaids for position updating.

The crew can tune the VORs manually using the control panels, or remotely using the CDU. If the HSI selector is not in a MAP or PLAN mode, the associated VOR must be manually tuned using the control panel. If the HSI is in a MAP or Plan mode, the AUTO/MAN Switch on the control panel must be selected to MAN to manually tune the VOR.

The NAV RADIO page displays auto–tuned or manually–tuned VOR data and allows remote tuning if the VOR control panel is in AUTO.

### **VOR Displays**

Left and right VOR bearings can be displayed on the RDMIs. When the VOR display is selected on the HSI, the selected course, frequency and course deviation are displayed. If the HSI is in a MAP mode, symbols indicate the position of tuned VORs and the selected course of manually tuned VORs are displayed.



## Marker Beacon

Each pilot has a set of marker beacon lights that show outer, middle and inner/airways beacon passage. Both sets are operated by the marker beacon receiver that is part of the left VOR receiver.

## Multi-Mode Receiver

Three Multi-Mode Receivers (MMRs) are installed. Each MMR includes an ILS and GPS receiver. The GPS receiver in the center MMR is not used.

## Instrument Landing System (ILS)

Three ILS receivers are installed. They are controlled by a single control panel on the aft aisle stand. Frequency changes are inhibited after localizer or glideslope capture if three autopilots are armed for approach. The selected runway front course is locked to prevent changes when the localizer is captured.

## ILS Displays

Localizer and glideslope deviation are shown on the ADIs and can be selected on the Standby Attitude Indicator and HSI. The ILS display on the HSI includes the selected front course and frequency in addition to the localizer and glideslope deviation.

Front or back course deviation is determined from airplane heading.

---

## Global Positioning System (GPS)

Left and right GPS receivers are independent and supply very accurate position data to the FMC. The GPS receivers are contained in the left and right Multi-Mode Receivers (MMRs). All GPS tuning is automatic.

## GPS Displays

Position Reference, page 3 of 4 (POS REF 3/4) displays the left and right GPS position.

## GPS Data

The FMC uses GPS data to refine the FMC position if the GPS is enabled and the GPS data is valid. If GPS data is not available or is unreliable the FMC will use the navigation radio position or IRS position data.

The GPS NAV prompt on POS REF page 3/4 can be used to inhibit GPS navigation data. The EICAS message GPS alerts the crew when data from both GPS systems are unavailable or when both systems have failed.

GPS position updates are allowed for all United States National Airspace approach operations. Outside of this region, GPS position updates are allowed during approaches only if the FMC database and approach charts are referenced to the WGS-84 reference datum. GPS updates should be inhibited for all other approach operations unless other appropriate procedures are used.

### GPS System Schematic

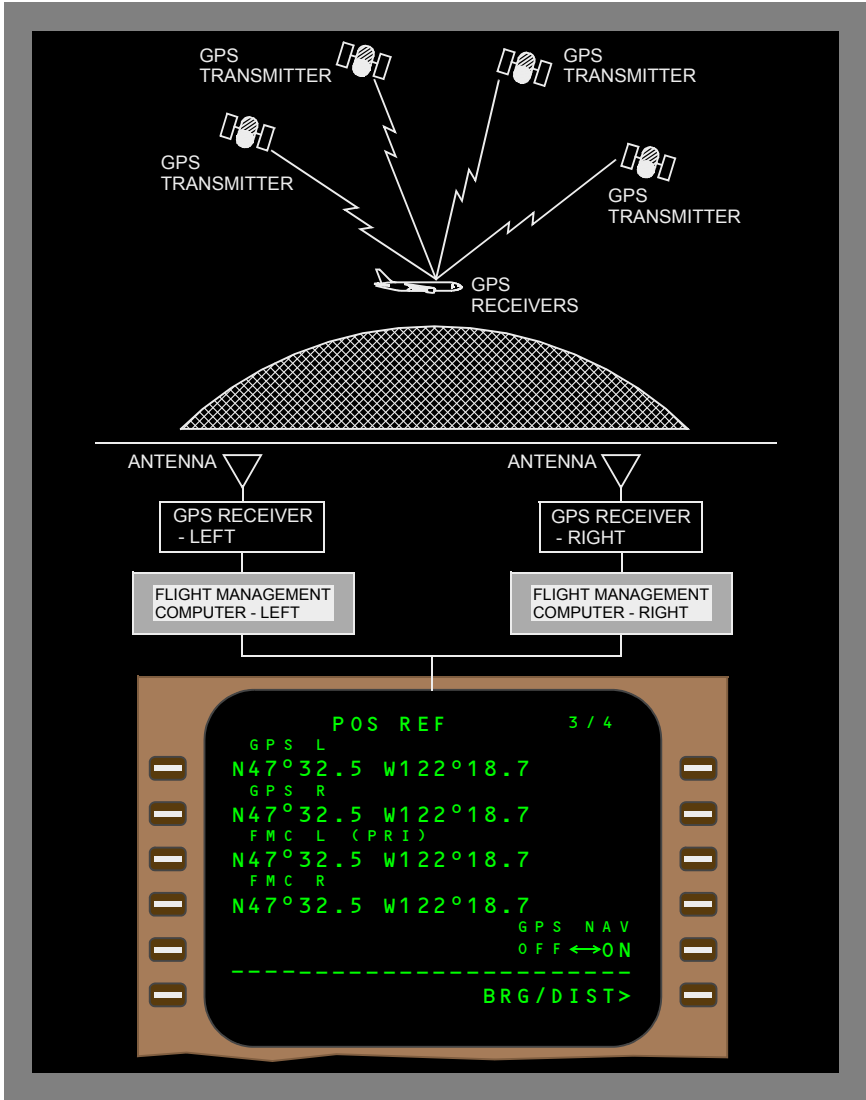

## **Transponder**

There are two ATC transponders installed. They are controlled by a single control panel and provide normal transponder functions and altitude reporting. The control panel is used to set the ATC code, operating mode, and to select which transponder is active.

The transponder is also capable of providing traffic alert and collision avoidance system (TCAS) indications. Select TA or TA/RA to enable traffic displays. Refer to Chapter 15, Warning systems, for a description of TCAS.

Failure of a transponder is indicated by the illumination of the amber ATC FAIL light on the control panel and the ATC FAULT advisory message on EICAS.

---

## **Weather Radar**

[Basic: [Weather radar single.](#)]

The weather radar system consists of a receiver–transmitter, an antenna, and a control panel.

[Option: [Weather radar dual.](#)]

The weather radar system consists of two receiver–transmitters, an antenna, and a control panel. A switch on the control panel selects which receiver–transmitter is used.

The EFIS control panel weather radar (WXR) switch controls power to the transmitter/receiver and selects the weather radar display on the respective HSI. The radar display range is set by the HSI range selected on the EFIS control panel. The receiver–transmitter is activated when either WXR switch is on.

Turbulence can be sensed by the weather radar only when there is sufficient precipitation. Clear air turbulence can not be sensed by radar.

The predictive windshear alerting system uses the weather radar to sense windshear. To provide windshear alerting the weather radar transmitter is activated on the ground when takeoff power is set and in flight when the airplane is below 2300 feet radio altitude. Radar returns are not displayed unless the WXR switch is ON.

Intentionally  
Blank

---

**Introduction**

The flight management system (FMS) aids the flight crew with navigation, in-flight performance optimization, automatic fuel monitoring, and flight deck displays. Automatic flight functions manage the airplane lateral flight path (LNAV) and vertical flight path (VNAV). The displays include a map for airplane orientation and command markers on the airspeed, altitude, and thrust indicators to help in flying efficient profiles.

The flight crew enters the applicable route and flight data into the CDUs. The FMS then uses the navigation database, airplane position, and supporting systems to calculate commands for manual and automatic flight path control.

The FMS tunes the navigation radios for position updating. The FMS navigation database supplies the necessary data to fly routes, SIDs, STARs, holding patterns, and procedure turns. Cruise altitudes and crossing altitude restrictions are used to calculate VNAV commands. Lateral offsets from the programmed route can be calculated and commanded.

---

**Flight Management Computer (FMC)**

The heart of the flight management system is the flight management computer. Under normal conditions, one FMC accomplishes the flight management tasks while the other FMC monitors. The second FMC is ready to replace the first FMC if system faults occur.

The FMC uses flight crew-entered flight plan data, airplane systems data, and data from the navigation database to calculate airplane present position and generate the pitch, roll, and thrust commands necessary to fly an optimum flight profile. The FMC sends these commands to the autothrottle, autopilot, and flight director. Map and route data are sent to the HSIs. The EFIS control panels are used to select the data to be displayed on the HSIs. The mode control panel selects the autothrottle, autopilot, and flight director operating modes. Refer to the following chapters for operation of these other systems:

- Chapter 4, Automatic Flight
- Chapter 10, Flight Instruments, Displays.

The FMC is certified for area navigation when used with navigation radio and/or GPS updating.

The FMC and CDU are used for enroute and terminal area navigation, RNAV approaches, and as a supplement to primary navigation means when conducting other types of nonprecision approaches.

## **Control Display Units (CDUs)**

Two CDUs are used to control the FMC.

The CDUs also provide alternate navigation capability if both FMCs fail (refer to the Alternate Navigation section of this chapter). The CDUs can also provide control of other systems which are accessed through the menu page.

## Introduction

When first powered, the FMS is in the preflight phase. As a phase is completed, the FMS changes to the next phase in this order:

- preflight
- takeoff
- climb
- cruise
- descent
- approach
- flight complete

## Preflight

During preflight, flight plan and load sheet data are manually entered into the CDU. The flight plan defines the route of flight from the origin to the destination and initializes LNAV. Flight plan and load sheet data provide performance data to initialize VNAV.

Required preflight data consists of:

- initial position
- route of flight
- performance data
- takeoff data

Optional preflight data includes:

- navigation database selection
- route 2
- alternate airport
- SID
- STAR
- wind

Each required or optional data item is entered on specific preflight pages.

Preflight starts with the IDENT page. If the IDENT page is not displayed, it can be selected with the IDENT prompt on the INIT/REF INDEX page. Visual prompts help the flight crew select necessary CDU preflight pages. Preflight pages can be manually selected in any order.

After the necessary data on each preflight page is entered and checked, push the lower right line select key to select the next preflight page. When ACTIVATE is selected on the ROUTE page, the execute (EXEC) light illuminates. Push the EXEC key to make the route active.

Use the departure/arrival (DEP/ARR) page to select a standard instrument departure (SID). Selection of the SID may cause a route discontinuity in the flight plan. The modification must be connected to the existing route and executed. This can be accomplished on the ROUTE or LEGS page.

When all required preflight entries are complete, PRE-FLT COMPLETE is displayed on the TAKEOFF REF page.

## Takeoff

The takeoff phase starts with engagement of takeoff thrust on the MCP and extends to the thrust reduction altitude where climb thrust is normally selected.

## Climb

The climb phase starts at the thrust reduction altitude and extends to the top of climb (T/C) point. The T/C is the position where the airplane reaches the cruise altitude entered on the PERF INIT page.

## Cruise

The cruise phase starts at the T/C point and extends to the top of descent (T/D) point. Cruise can include step climbs and en route descents.

## Descent

The descent phase starts at the T/D point or when the VNAV descent page becomes active. The descent phase extends to the start of the approach phase.

## Approach

The approach phase starts when intercepting the first leg of a published approach selected from the ARRIVALS page.

## Flight Complete

Thirty seconds after engine shutdown, the flight complete phase clears the active flight plan and load data. Some preflight data fields initialize to default values in preparation for the next flight.

---

## Operational Notes

When operating in the LNAV and VNAV modes, system operation must be monitored for unwanted pitch, roll, or thrust commands. If unwanted operation is noticed, roll and pitch modes other than LNAV and VNAV must be selected.

The system must be carefully monitored for errors following:

- activation of a new data base
- power interruption
- IRS failure.

When operating far off the route, the FMC may not sequence the active waypoint when the airplane passes abeam the waypoint.

LNAV can only capture the active leg. It cannot capture an inactive leg in the active route. The DIRECT TO or INTERCEPT COURSE TO procedures can be used to create an active leg for capture.



When a waypoint is in the route more than once, certain route modifications (such as DIRECT TO and HOLD) use the first waypoint in the route.

Some SIDs or STARS contain a heading vectors leg. VECTORS waypoints display on the HSI map as a magenta line without an end point leading away from the airplane symbol. If LNAV is engaged, the DIRECT TO or INTERCEPT COURSE TO procedure can be used to start waypoint sequencing beyond the vectors leg.

When entering airways in a route page, the start and end waypoints must be in the data base. Otherwise, the route segment must be entered as a DIRECT leg.

If the engines remain operating between flights, entering a new cruise altitude before the next flight recalculates the proper vertical profile.

If a climb to cruise altitude is necessary after completing a descent, a new cruise altitude entry must be made. Cruise altitude can be entered on the CLB page.

Direct-to courses are segments of a great circle route. When entering a direct-to waypoint on the LEGS page, the course above the waypoint before execution is the arrival course at the waypoint. However, after execution, the course is the current course to fly to the waypoint. These courses may not be the same.

---

## Terminology

The following paragraphs describe FMC and CDU terminology.

Active – flight plan data being used to calculate LNAV or VNAV guidance commands.

Activate – the procedure to change an inactive route to the active route for navigation. It is a two step procedure.

- select the ACTIVATE prompt
- push the execute (EXEC) key.

Altitude constraint – a crossing restriction at a waypoint.

Delete – using the delete (DEL) key to remove FMC data and revert to default values, dash or box prompts, or a blank entry.

Econ – a speed schedule calculated to minimize operating cost. The economy speed is based on the cost index. A low cost index causes a lower cruise speed. Maximum range cruise or the minimum fuel speed schedule may be obtained by entering a cost index of zero. This speed schedule ignores the cost of time.

A low cost index may be used when fuel costs are high compared to operating costs.

A minimum time speed schedule may be obtained by entering a cost index of 9999. This speed schedule calls for maximum flight envelope speeds.

---

Enter – put data in the CDU scratchpad and line select the data to the applicable location. New characters can be typed or existing data can be line selected to the scratchpad for entry.

Erase – remove entered data, which has resulted in a modification, by selecting the ERASE prompt.

Execute – push the illuminated EXEC key to make modified data active.

Inactive – data not being used to calculate LNAV or VNAV commands.

Initialize – entering data required to make the system operational.

Message – FMC information displayed in the scratchpad.

Modify – to change active data. When a modification is made to the active route or performance mode, MOD displays in the page title, ERASE displays next to line select key 6 left, and the EXEC key illuminates.

Prompt – CDU symbol that aids the flight crew in accomplishing a task. Prompts can be boxes, dashes, or symbols (< or >) to remind the flight crew to enter or select data.

Reset – a self protection function which causes an FMC to shutdown and restart when an error is detected. Current flight and performance data is automatically re-loaded from the other FMC during the reset.

Select – pushing a key to obtain the necessary data or action, or to copy selected data to the scratchpad.

Speed restriction – an airspeed limit associated with a specified altitude entered by the flight crew.

Speed transition – an airspeed limit associated with a specified altitude entered by the FMC.

Waypoint – a point on the route or in the navigation database. It can be a fixed point such as a latitude and longitude, VOR or ADF station, or an airway intersection. A conditional waypoint is not associated with a land reference; it is based on a time or altitude requirement. An example of a conditional waypoint is "when reaching 1000 feet".

---

## Navigation Position

The FMC determines present position from these navigation systems:

- IRS
- navigation radios
- GPS

The FMC uses its calculated present position to generate lateral steering commands along the active leg to the active waypoint. The FMC requires position data from the IRS. All other position sources are validated against the IRS position and increase the accuracy of the FMC position.

## **FMC Position Update**

On the ground, the FMC calculates present position based on IRS and/or the GPS data.

FMC position may be manually updated to any of the navigation system positions. This update is accomplished on POS REF page 2.

If GPS NAV is OFF, the FMC updates position to the takeoff runway threshold when the THR switch is pushed. The runway data is on the TAKEOFF REF page. When an intersection takeoff is made, the intersection displacement distance from the runway threshold must be entered on the TAKEOFF REF page. If GPS NAV is ON, the THR update is inhibited. GPS NAV is on POS REF page 3/4.

In flight, the FMC position is continually updated from the GPS, navigation radios, and the IRS. Updating priority is based on the availability of valid data from the supporting systems.

The FMC automatically tunes the VOR, DME, and ILS radios for position updates.

FMC position updates from navigation sensor positions follow this priority:

- one LOC and GPS (tuned for approach)
- one LOC and collocated DME (tuned for approach)
- one LOC and VOR with collocated DME (tuned for approach)
- LOC (tuned for approach)
- GPS
- two DME stations
- one VOR with a collocated DME
- IRS.

The station identifiers of the tuned radio navigation aids are displayed on the POS REF page 2.

Primary FMC Position Update Source	POS REF page 2/4
GPS	GPS
LOC, GPS valid*	LOC–GPS
LOC, DME DME valid; GPS invalid*	LOC–RADIO
LOC, VOR DME valid; GPS invalid*	LOC–RADIO
LOC valid; GPS, DME, VOR invalid*	LOC
DME DME valid; GPS invalid	RADIO
VOR DME valid; GPS invalid	RADIO
GPS, VOR, DME invalid	IRS
IRS invalid (no navigation capability)	blank
* The FMC changes to LOC updating when: <ul style="list-style-type: none"> <li>• the tuned localizer is associated with the destination runway</li> <li>• valid localizer signal is being received</li> <li>• the airplane is within the criteria to ensure accurate LOC updating.</li> </ul>	

## FMC Polar Operations

The FMC automatically starts polar operations when the calculated airplane position enters a polar region.

With the heading reference switch in normal, automatic switching of all flight display inputs to true north reference occurs when entering a polar region. The change to true heading reference is annunciated by a flashing white box around the word TRU on the HSI. TRUE heading reference can be manually selected when outside the polar region by placing the heading reference switch in the TRUE position. When changing back to magnetic reference, the HSI displays a green box around the word MAG to annunciate the change. If the heading reference is TRU in the descent phase, the HSI displays an amber box around the word TRU.

The navigation and display system does not support operations at latitudes greater than 87° North or South.

### FMC Polar Regions

Polar regions are all areas above 73° North or below 60° South. Magnetic headings are not available in these areas.

## Navigation Performance

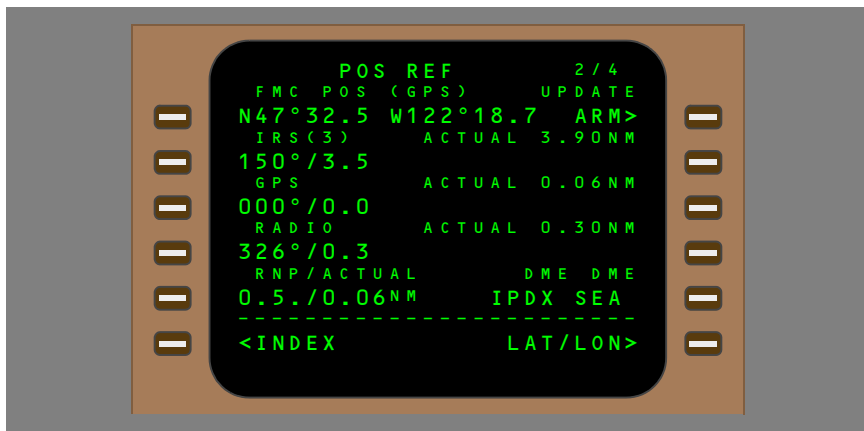

The FMC uses data from the navigation systems to accurately calculate the position of the airplane. The current FMC position is displayed on line 1 of POS REF page 2. The primary source of update is shown in parentheses above the FMC position. The positions of each of the navigation systems is shown in lines 2 through 4. The flight crew can change the display format from latitude/longitude to bearing/distance format. The bearing/distance is from the FMC position to the individual navigation system position.

### Actual Navigation Performance

Actual navigation performance (ANP) is the FMC's current computed position accuracy. It is shown on POS REF page 2 (line 5L) titled ACTUAL. ACTUAL navigation performance is expressed in nautical miles. It represents the radius of a circle centered at the FMC position which defines the limit of the potential error in that position. The smaller the ANP the more accurate the FMC position.

ACTUAL navigation performance is also computed for each of the navigation systems and those values are displayed on POS REF page 2 adjacent to the system name. The systems' ACTUAL navigation performance is equivalent to the one calculated for the FMC.

After a manual position update, the ACTUAL navigation performance of the FMC changes to the ACTUAL navigation performance of the selected navigation system. In the example above, a manual position update to the INERTIAL system would change the FMC ACTUAL navigation performance to 3.9 NM. The FMC then updates from the best available navigation system and eventually, the manual update has no effect on position calculation. Some automatic updates can be inhibited; GPS on POS REF page 3 and VOR/DME updates on the REF NAV DATA page. Inertial and DME/DME updates can not be inhibited.

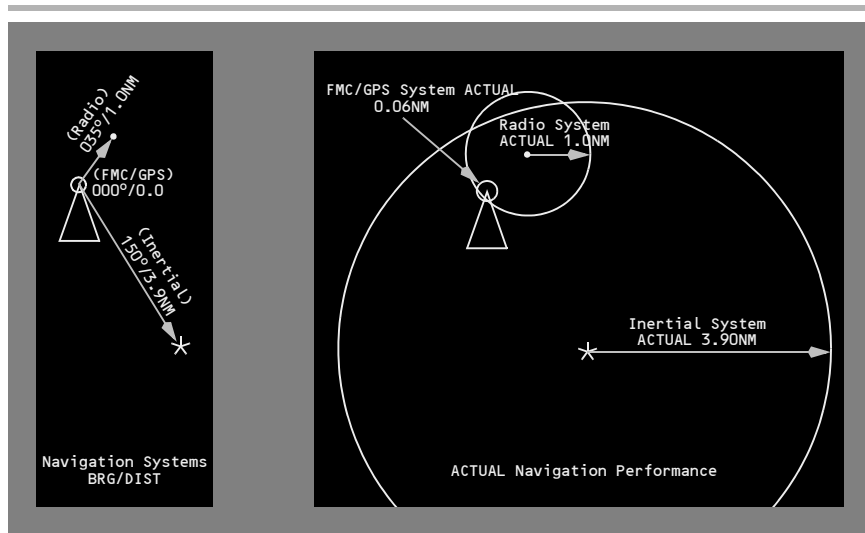

## Required Navigation Performance

Required navigation performance (RNP) values have been created and published for certain areas of operation and procedures. The RNP, expressed in nautical miles, defines the accuracy of the navigation equipment required to fly the route or procedure for which it is published. ACTUAL navigation performance should not exceed RNP. The FMC triggers the EICAS message UNABLE RNP to alert the flight crew if ANP exceeds RNP. The FMC supplies a default RNP value for takeoff, enroute, oceanic/remote, terminal, and approach phases of flight. RNP is displayed on POS REF page 2. The flight crew may enter an RNP value, if required.

## Lateral Navigation (LNAV)

LNAV provides steering commands to the next waypoint or the selected route intercept point. When armed on takeoff, LNAV engages at or above 50 feet when laterally within 2.5 nautical miles of the active route leg. FMC LNAV guidance normally provides great circle courses between waypoints. However, when an arrival or approach from the FMC data base is entered into the active route, the FMC commands a heading, track, or a DME arc to comply with the procedure.

## Waypoints

Waypoint (navigation fix) identifiers display on the CDU and HSI.

The CDU message NOT IN DATABASE is displayed if a manually entered waypoint identifier is not in the data base. The waypoint can still be entered as a latitude/longitude, place-bearing/distance or a place-bearing/place-bearing waypoint.

FMC-generated waypoints contain a maximum of five characters assigned according to the following rules.

### **Navaid Waypoints**

VHF – waypoints located at VHF nav aids (VOR/DME/LOC) are identified by one, two, three or four character facility identifier. Examples:

- Los Angeles VORTAC – LAX
- Tyndall TACAN – PAM
- Riga Engure, Latvia – AN.

NDB – waypoints located at NDBs are identified by use of the station identifier. Example: FORT NELSON, CAN – YE.

### **Fix Waypoints**

Waypoints located at fixes with names containing five or fewer characters are identified by the name. Examples:

- DOT
- ACRA
- ALPHA.

### **Long Waypoint Names**

Waypoints with more than five characters are abbreviated using the following rules sequentially until five characters remain. For double letters, one letter is deleted. Example:

- KIMMEL becomes KIMEL

Keep the first letter, first vowel and last letter. Delete other vowels starting from right to left. Example:

- BAILEY becomes BAILY

The next rule abbreviates names even further. Apply the previous rule, then delete consonants from right to left. Example:

- BRIDGEPORT becomes BRIDGPRT then BRIDT

Fixes with multiword names use the first letter of the first word and abbreviate the last word, using the above rules sequentially until a total of five characters remain. Examples:

- CLEAR LAKE becomes CLAKE
- ROUGH ROAD becomes RROAD.

---

## Unnamed Waypoints

If an unnamed turn point, intersection, or fix is collocated with a named waypoint or navaid on a different route structure (such as low altitude routes or an approach), the name or identifier of the collocated waypoint is used. Example:

- Unnamed turn point on J2 between the Lake Charles (LCH) and New Orleans (MSY) VORTACs is coincidental with the Lafayette (LFT) low altitude VORTAC. LFT is used as the identifier for the turn point.

Identifier codes for unnamed turn points not coincidental with named waypoints are constructed from the identifier of a navaid serving the point and the distance from the navaid to the point. If the distance is 99 nautical miles or less, the navaid identifier is placed first, followed by the distance. If the distance is 100 nautical miles or more, the last two digits are used and placed ahead of the navaid identifier. Examples (NAVAID – DISTANCE – IDENT):

- INW – 18 – INW18
- CSN – 106 – 06CSN

Waypoint located at unnamed flight information region (FIR), upper flight information region (UIR), and controlled airspace reporting points are identified by the three-letter airspace type identification followed by a two-digit sequence number. Example:

- FRA01

Unnamed oceanic control area reporting points in the northern hemisphere use the letters N and E, while points in the southern hemisphere use the letters S and W. Latitude always precedes longitude. For longitude, only the last two digits of the three digit value are used.

Placement of the designator in the five character set indicates whether the first longitude digit is 0 or 1. The letter is the last character if the longitude is less than 100° and is the third character if the longitude is 100° or greater.

N is used for north latitude, west longitude. E is used for north latitude, east longitude. S is used for south latitude, east longitude. W is used for south latitude, west longitude. Examples:

- |                            |                             |
|----------------------------|-----------------------------|
| • N50° W040° becomes 5040N | • S52° W075° becomes 5275W  |
| • N75° W170° becomes 75N70 | • S07° W120° becomes 07W20  |
| • N50° E020° becomes 5020E | • S50° E020° becomes 5020S  |
| • N06° E110° becomes 06E10 | • S06° E110° becomes 06S10. |

## Procedure Arc Fix Waypoint Names

Unnamed terminal area fixes along a DME arc procedure are identified with the first character D. Characters 2 through 4 indicate the radial on which the fix lies. The last character indicates the arc radius. The radius is expressed by a letter of the alphabet where A = 1 mile, B = 2 miles, C = 3 miles and so forth. Example:

- EPH252°/24 = D252X



An unnamed waypoint along a DME arc with a radius greater than 26 miles is identified by the station identifier and the DME radius. Example:

- CPR338°/29 = CPR29

When there are multiple unnamed waypoints along a DME arc with a radius greater than 26 miles, the station identifier is reduced to two characters, followed by the radius, and then a sequence character. Examples:

- CPR134°/29 = CP29A
- CPR190° /29 = CP29B

DME step down fixes are identified by the distance and a "D".

Examples: 138D, 106D, 56D, 3D.

### Procedure Fix Waypoints

Marker beacons are identified by the marker type identifier followed by the runway number. Examples:

- Outer Marker 13R = OM13R
- Middle Marker 21 = MM21.

Waypoints located at unnamed runway-related fixes are identified by adding a two-letter prefix to the runway number. The following list is used to determine the applicable prefix:

- |                                  |  |
|----------------------------------|--|
| • RX – runway extension fix      | • BM – back course marker                  |
| • FA – VFR final approach fix    | • MD – minimum descent altitude            |
| • CF – final approach course fix | • A – (+ an alpha) step down fix           |
| • FF – final approach fix        | • RW – runway threshold                    |
| • IF – initial approach fix      | • MA – missed approach point other than RW |
| • OM – outer marker              | • TD – touchdown point inboard of RW.      |
| • MM – middle marker             |  |
| • IM – inner marker              |  |

Examples: OM25L, MM09, IM23, RW04, RW18L.

For airports with more than one approach to the same runway, the two letter prefix may change to allow different identifiers for the same waypoint. The first letter identifies the type of fix and the second letter identifies the type approach as follows:

- |                                      |                             |
|--------------------------------------|-----------------------------|
| • C() – final approach course fix    | • ()L – localizer only      |
| • F() – final approach fix           | • ()B – backcourse ILS      |
| • P() – missed approach point        | • ()D – VOR/DME             |
| • I() – initial approach fix         | • ()V – VOR only            |
| • D() – minimum descent altitude     | • ()S – VOR with DME points |
| • T() – touch down point             | • ()N – NDB                 |
| • R() – runway centerline intercept. | • ()Q – NDB with DME points |
| • ()I – ILS                          | • ()M – MLS                 |
|                                      | • ()T – Tacan               |
|                                      | • ()R – RNAV                |

Examples: CI32R, PV15, FN24L.

Unnamed turn points that are part of a procedure are identified as a latitude and longitude waypoint. These include waypoints (except conditional waypoints) defined by flying a course or track from a waypoint (except conditional waypoints) to a radial or DME distance. These waypoints are automatically entered in a route by selection of a procedure using these waypoints, from the departures or arrivals page.

Airport reference points are identified by the ICAO identifier.

### **Duplicate Waypoints**

Application of the abbreviation rules may create identical identifiers for different waypoints. When a duplicate waypoint identifier is entered, the page changes to the SELECT DESIRED WPT page. The page lists the latitude, longitude, and the type of facility or waypoint of all the waypoints with the same identifier. Select the latitude/longitude of the correct waypoint to enter the correct waypoint on the original page.

### **Conditional Waypoints**

Conditional waypoints are automatically entered into a route as a result of selecting a procedure on the DEPARTURES or ARRIVALS page. Usually, conditional waypoints cannot be manually entered on a route or legs page. These waypoints indicate when an event occurs and are not at a geographically-fixed position. The types of conditions are:

- climb/descent through an altitude
- flying a heading to a radial or DME distance
- intercepting a course
- heading vectors to a course or fix.

Altitude and course intercept conditional waypoints display on the CDU inside (parenthesis) marks. The diagram below shows conditional waypoints.

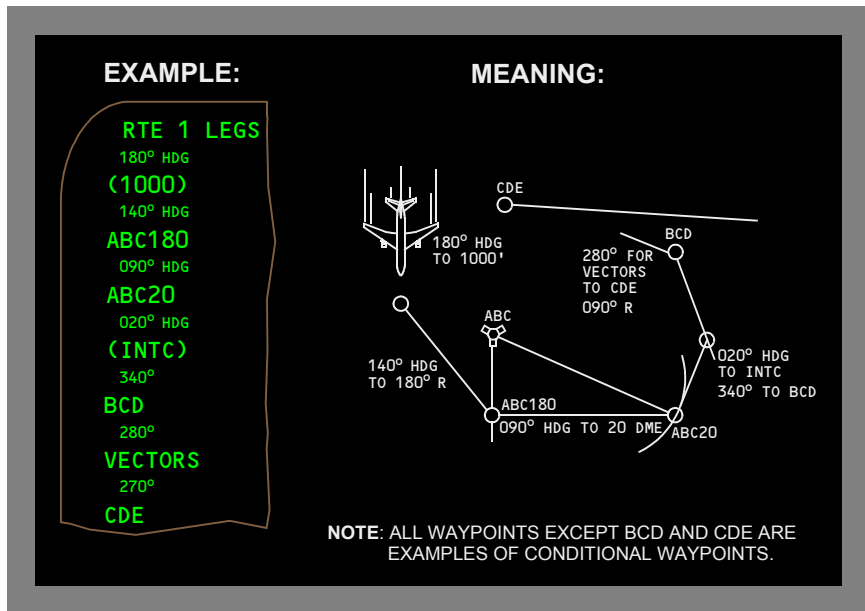

### Manually Entered Latitude/ Longitude Waypoints

Pilot defined waypoints entered as a latitude and longitude are shown in a seven-character format. Latitude and longitude waypoints are entered with no space or slash between the latitude and longitude entries. Leading zeroes must be entered. All digits and decimal points (to 1/10 minute) must be entered unless the latitude or longitude are full degrees. Examples:

- N47° W008° is entered as N47W008 and displays as N47W008
- N47° 15.4' W008° 3.4' is entered as N4715.4W00803.4 and displays as N47W008.

### Manually Entered Place-Bearing/Distance or Place-Bearing/Place-Bearing Waypoints

Waypoints entered as a place-bearing/distance or place-bearing/place-bearing are identified by the first three characters of the entry followed by a two-digit sequence number. Examples:

- SEA330/10 becomes SEA01
- SEA330/OLM020 becomes SEA02.

The two digit sequence numbers reserved for RTE1 are 01 through 49. The two digit sequence numbers reserved for RTE2 are 51 through 99.

---

## Manually Entered Airway Crossing Waypoints

Airway crossing fixes are entered as a five character waypoint name or by entering consecutive airways on the ROUTE page. In the latter case, the display is an X followed by the second airway name. Example: entering J70 on the VIA line of the ROUTE page causes box prompts to display opposite on the same line. Leaving the box prompts empty and entering J52 on the next VIA line, directly below J70, causes the FMC to calculate the intersection of the two airways and replace the boxes with the waypoint identifier, XJ52.

## Manually Entered Latitude or Longitude Reporting Point Waypoints

Latitude or longitude reporting waypoints are entered as the full latitude or longitude followed by a dash, then the increment chosen for the following multiple waypoints. Example:

- W060–10 adds waypoints starting at W060 in ten degree increments from that point to the destination
- the entry must be made on a LEGS page on any line before the first reporting point
- usually, this entry is made on the active waypoint line and proper sequencing is performed by the FMC.

## Manually Entered Along–Track Waypoints

Along–track waypoints are created on the active route and do not cause route discontinuities when they are created.

Along–track waypoints are entered using the waypoint name (the place), followed by a slash and minus sign, for points before the waypoint, or no sign for points after the waypoint, followed by the mileage offset for the newly defined waypoint. The created waypoint is then inserted over the original waypoint. The distance offset must be less than the distance between the originating waypoint and next (positive value) or preceding (negative value) waypoint. Latitude and longitude waypoints cannot be used to create along–track waypoints. Examples:

- VAMPS/25 is 25 miles after VAMPS on the present route and displays as VAM01
- ELN/-30 is 30 miles before ELN on the present route and displays as ELN01.

## Engine Out SID

An engine out SID is a procedure developed by an airline for a particular runway to provide unique routing if an engine fails on takeoff. If the database contains an EO SID for the takeoff runway and an engine fails while the flaps are extended, the active route is automatically modified to the engine out route. The modification may be either executed or erased.

## **HSI Map Displays**

The route is displayed on the HSI in MAP, and PLAN modes. The display color and format represent the following status:

- an inactive route is displayed as a cyan dashed line
- an activated, but not yet executed route, is displayed as a white dashed line
- the active route is displayed in magenta
- modifications to an active route are shown as dashed white lines
- modified waypoints are displayed in white
- executed route offsets are displayed as a dashed magenta line.

The HSI displays the FMC position at the apex of the airplane symbol. All HSI map data displays relative to this apex.

When adequate GPS or radio updating is not available, the HSI map may display a shift error.

This error results in the displayed position of the airplane, route, waypoints and navigation aids being shifted from their actual position. An undetected, across track map shift may result in the airplane flying a ground track that is offset from the desired track. An undetected, along track map shift may result in the flight crew initiating altitude changes earlier or later than desired. In either case, an undetected map shift may compromise terrain or traffic separation.

Map shift errors can be detected by comparing the position of the airplane on the HSI map with data from the ILS, VOR, DME, and ADF systems.

---

## **Vertical Navigation (VNAV)**

VNAV provides vertical profile guidance through the climb, cruise, and descent phases of flight.

### **Speed/Altitude Constraints**

VNAV controls the path and speed to comply with waypoint crossing constraints. Waypoint crossing constraints are entered on the LEGS page waypoint line by pushing the applicable key on the right side of the CDU. Barometric altitude constraints must be below the cruise altitude to be valid. Values entered as part of a procedure and manually entered constraints are shown in large font. FMC predicted values do not act as constraints, and are displayed in small font.

Waypoints can have altitude or airspeed/altitude constraints. Speed constraint entries require an altitude constraint at the same waypoint. All speed constraints are considered by the FMC as at or below constraints.

At or above altitude constraints are entered with a suffix letter A (example: 220A).  
At or below altitude constraints are entered with a suffix letter B (example: 240B).  
Mandatory altitude constraints are entered without any suffix letter (example: 270).

Altitude constraints with two altitudes may be entered in either order. The lower altitude constraint, followed by a suffix letter A, and the upper altitude constraint, followed by a suffix letter B (example: 220A240B or 240B220A).

## Takeoff and Climb

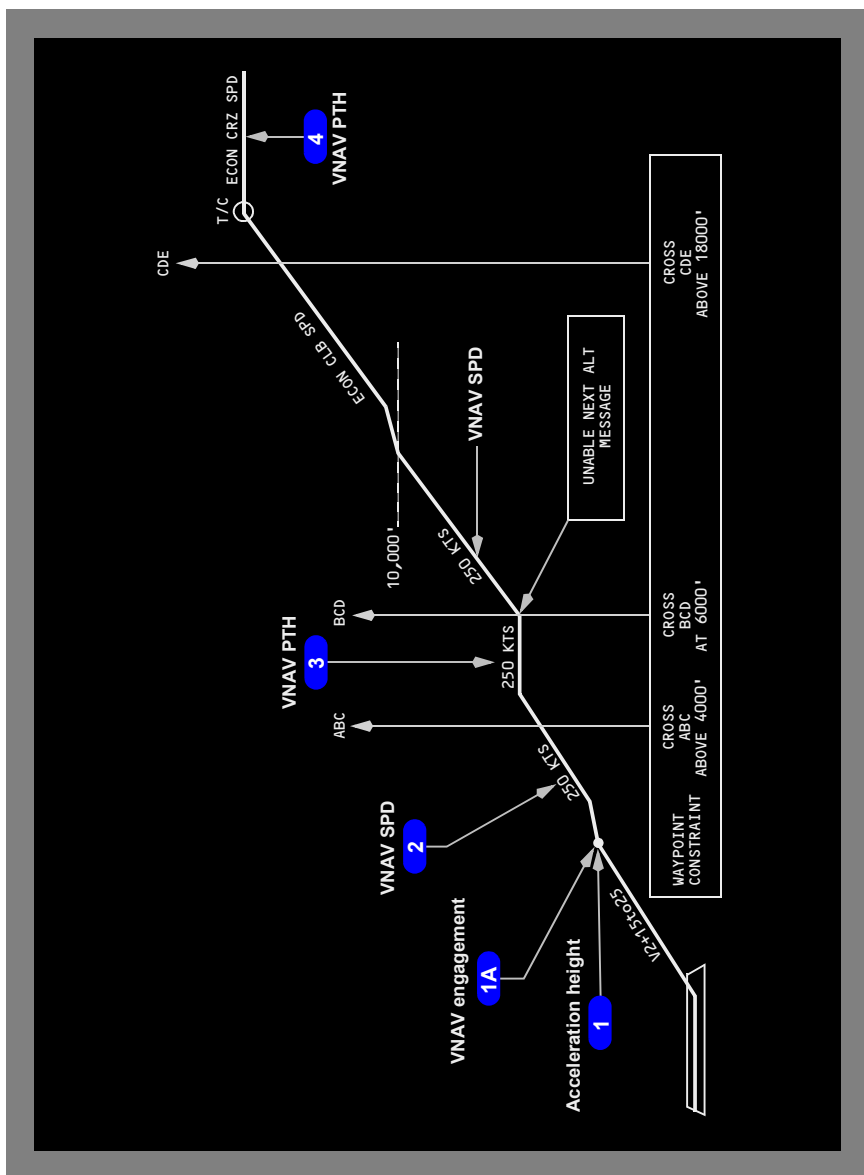

### 1 Acceleration Height

Height at which acceleration is initiated for flap retraction, normally 1000 feet. Takeoff (TO) pitch mode is used for takeoff and initial climb up to this point.

## **1A VNAV Engagement**

VNAV is normally engaged at acceleration height. Pitch guidance then commands:

- an airspeed increase to 250 knots, or
- the speed transition associated with the origin airport, or
- the takeoff target airspeed (between  $V_2 + 15$  and  $V_2 + 25$  knots) if the acceleration altitude entered on TAKEOFF REF page 2/2 has not been reached

Initial reduction of flaps after VNAV is engaged also initiates pitch guidance to accelerate to 250 knots.

When VNAV is engaged (above 400 feet) the thrust reference changes to climb.

## **2 VNAV Climb**

The VNAV climb profile uses VNAV SPD or VNAV PTH at the default climb speed or pilot selected climb speed to remain within all airspeed and altitude constraints that are part of the SID entered into the active route. Autothrottle uses selected climb thrust limit.

## **3 Climb Constraints**

VNAV enters the VNAV PTH mode to remain within departure or waypoint constraints. Speed maintained during this time can be:

- procedure based speed restriction
- waypoint speed restriction
- default VNAV climb speed
- manually entered climb speed.

If the FMC predicts the airplane will not reach an altitude constraint, the message UNABLE NEXT ALT is displayed on the CDU. Speed intervention can be used by pushing the IAS/MACH selector and manually setting a lower airspeed to provide a steeper climb or climb derates can be deleted.

## **4 Top Of Climb (T/C)**

The point where the climb phase meets the cruise altitude is called the top of climb. Approaching this point, the FMC changes from the climb phase to the cruise phase. The T/C is displayed any time the FMC calculates a change from a climb phase to a cruise phase, such as a step climb.

The T/C point is displayed on the map as a green open circle with the label T/C.



## Cruise

At cruise altitude, the FMC commands economy cruise speed or the pilot entered speed until reaching the top-of-descent (T/D) point. Alternate cruise speed options are:

- long range (LRC)
- engine out (ENG OUT), or
- flight crew entered speed.

If the cost index is set to zero the FMC commands maximum range cruise speed. Cost index modifications are allowed until within ten miles of the top of descent.

### Cruise Climb

When VNAV is engaged, resetting the MCP to an altitude higher than the current cruise altitude causes the new altitude to be displayed in the scratchpad of the CDU. The altitude can then be entered on the CRZ ALT line on the cruise page. When the modification is executed the airplane will climb to the new cruise altitude. The CRZ page displays ACT ECON CRZ CLB.

### Step Climb

Fuel and ETA predictions assume the airplane climbs at each predicted step climb point as airplane weight decreases. FMC predicted step climb increments are based on the step size entered on the CRZ page. Entering a step size of zero causes the FMC to assume a constant altitude cruise. Flight crew entry of a step altitude on the CRZ page overrides the FMC step climb predictions.

Entry of a planned step point and altitude on the RTE LEGS page overrides a "Step To" entry made on the CRZ page.

Predicted or planned step altitudes are displayed on the RTE LEGS page. The distance and ETA to the next step point is displayed on the CRZ and progress pages. Step points are displayed on the HSI map with a green circle and S/C label.

### Cruise Descent

Resetting the MCP to an altitude below the current cruise altitude causes the new altitude to be copied to the scratchpad if the altitude change is 4000 feet or less. The new cruise altitude can be entered on the cruise page. When the modification is executed the CRZ page displays ACT ECON CRZ DES. If the altitude set in the altitude window is below the speed transition (SPD TRANS) or restriction (SPD RESTR) altitude displayed on the DES page, those altitudes and speeds are deleted and the airplane will maintain cruise speed during the descent.

**Note:** A cruise descent will not provide speed adjustments to comply with speed restrictions or transition altitude speeds. Transition or speed restrictions must be maintained by flight crew action.

## Mode Control Panel Speed Intervention

With VNAV engaged, pushing the IAS MACH selector enables speed intervention. Speed intervention allows the flight crew to change airplane speed with the IAS/MACH selector.

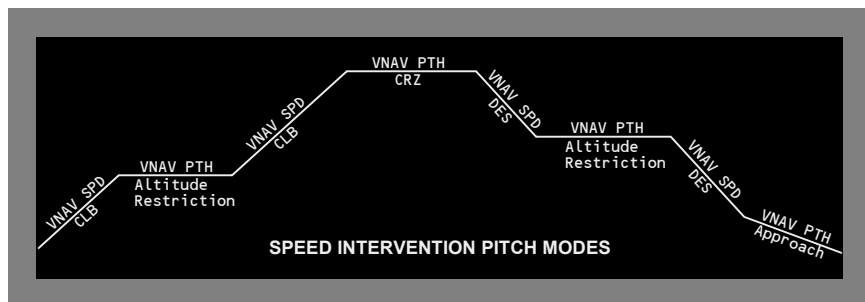

The above illustration shows VNAV mode for each phase of flight during speed intervention.

**Note:** The FMC does not use the speed set on the MCP for fuel or ETA predictions so FMC predictions are not accurate if speed intervention is used for an extended period.

In VNAV PTH mode, thrust controls speed; in VNAV SPD mode, pitch controls speed.

If speed intervention is selected during a VNAV PTH descent, VNAV PTH pitch mode changes to VNAV SPD and the airplane may depart the FMC calculated descent path. In all other phases of flight, the AFDS captured pitch mode remains unchanged when speed intervention is selected.

In approach phase (see Approach topic this chapter/section), during speed intervention, pitch mode remains in VNAV PTH and the vertical path is maintained regardless of IAS/MACH selector changes.

### Descent

The FMC calculates a descent path based on airspeed and altitude constraints and the end of descent (E/D) point. Dashes display on the LEGS page for speed and altitude descent waypoints. When an arrival or approach procedure is selected on the ARRIVALS page and incorporated into the flight plan, the FMC creates an E/D. The E/D is located 50 feet above the runway threshold (RW waypoint) for all approaches except VOR approaches. The E/D for VOR approaches is the missed approach point; which may be the VOR, runway waypoint (RWXXX), or a named waypoint. During cruise, an E/D is also created when an altitude constraint is entered on the LEGS page on a downstream waypoint.

The top of descent (T/D) point is the point where the cruise phase changes to the descent phase. It displays on the HSI as a green circle with the label T/D. The descent path starts at the T/D and includes any waypoint altitude constraints. The path to the first constraint is based on:

- idle thrust
- speedbrakes retracted
- FMC cruise wind
- wind entries on the DESCENT FORECAST page
- predicted use of anti-ice
- applicable target speed

The descent may be planned at economy Mach/CAS (based on Cost Index) or a manually entered Mach/CAS. VNAV will not command an economy target speed greater than VMO/MMO minus 16 knots or a pilot entered speed greater than VMO/MMO minus 11 knots.

The FMC creates the descent path with a deceleration at the speed transition altitude (typically 250 knots below 10,000 feet). VNAV plans a speed target 10 knots below the transition speed to allow for unknown tailwinds.

Descent path segments after the first altitude constraint waypoint are constructed as straight line point-to-point segments. If the VNAV path segment is too shallow to be flown satisfactorily at IDLE thrust, the FMC commands speed on thrust levers (SPD). Elevators control the shallow descent path.

If the airplane passes the T/D point and the window altitude has not been set lower, or if the airplane levels at an MCP altitude not in the FMC descent profile, ALT HOLD annunciates. The MCP altitude must be reset and VNAV re-engaged to initiate/continue the descent.

If flight plan modifications or unknown winds occur when above the first speed constraint, VNAV varies speed to maintain the path up to the following limits:

- with greater than 15 knots below the target speed, the autothrottle changes from IDLE/HOLD to SPD to provide thrust to accelerate to the target speed. If the autothrottle is not active, the scratchpad message THRUST REQUIRED displays. The airspeed may decrease to minimum maneuvering speed. Subsequently, VNAV commands the airplane to fly below the path to stop the deceleration. If VNAV can no longer maintain the airplane within 150 feet of the path without further deceleration, speed reversion occurs, the pitch mode annunciation changes from VNAV PTH to VNAV SPD, VNAV resets the target speed to 5 knots above the greater of best holding speed or minimum maneuvering speed, and the scratchpad message THRUST REQUIRED displays again
- with greater than VMO/MMO minus 16 knots, the scratchpad message DRAG REQUIRED displays. The airplane may accelerate up to VMO/MMO minus 11 knots to maintain the path. If further correction is required, VNAV may allow the airplane to rise up to 150 feet above the path. If VNAV can no longer maintain the airplane within 150 feet of the path without further acceleration, speed reversion occurs, the pitch mode annunciation changes from VNAV PTH to VNAV SPD, VNAV resets the target speed to VMO/MMO minus 16 knots, and the scratchpad message DRAG REQUIRED displays again

If flight plan modifications or unknown winds occur when below the first speed constraint, VNAV varies speed to maintain the path up to the following limits:

- with greater than 10 knots below the target speed, the autothrottle changes from IDLE/HOLD to SPD to provide thrust to accelerate to the target speed. If the autothrottle is not active, the scratchpad message THRUST REQUIRED displays. The airspeed may decrease to minimum maneuvering speed. Subsequently, VNAV commands the airplane to fly below the path to stop the deceleration. If VNAV can no longer maintain the airplane within 150 feet of the path without further deceleration, speed reversion occurs, the pitch mode annunciation changes from VNAV PTH to VNAV SPD, VNAV commands a speed 10 knots less than the transition speed for the destination airport (not less than minimum maneuvering speed), and the scratchpad message THRUST REQUIRED displays again
- with greater than 10 knots above target speed, the scratchpad message DRAG REQUIRED displays. The airplane may accelerate up to 15 knots above target speed to maintain the path. The maximum speed excursion allowed is 5 knots above the transition speed after the airplane is below transition altitude for the destination airport or 5 knots below the flaps placard speed if flaps are extended. If further correction is required, VNAV may allow the airplane to rise up to 150 feet above the path to stop the acceleration. If VNAV can no longer maintain the airplane within 150 feet of the path without further acceleration, speed reversion occurs, the pitch mode annunciation changes from VNAV PTH to VNAV SPD, VNAV commands a speed 10 knots less than the transition speed for the destination airport, and the scratchpad message DRAG REQUIRED displays again.

### Early Descent

When a descent is started before the T/D, VNAV commands a descent at a reduced descent rate until the idle descent path is intercepted.

Start an early descent by resetting the MCP altitude, then selecting the DES NOW prompt on the DES page. In an early descent, the autothrottle mode annunciation is initially THR, followed by HOLD, allowing the pilot to adjust the rate of descent. The pitch mode is VNAV SPD.

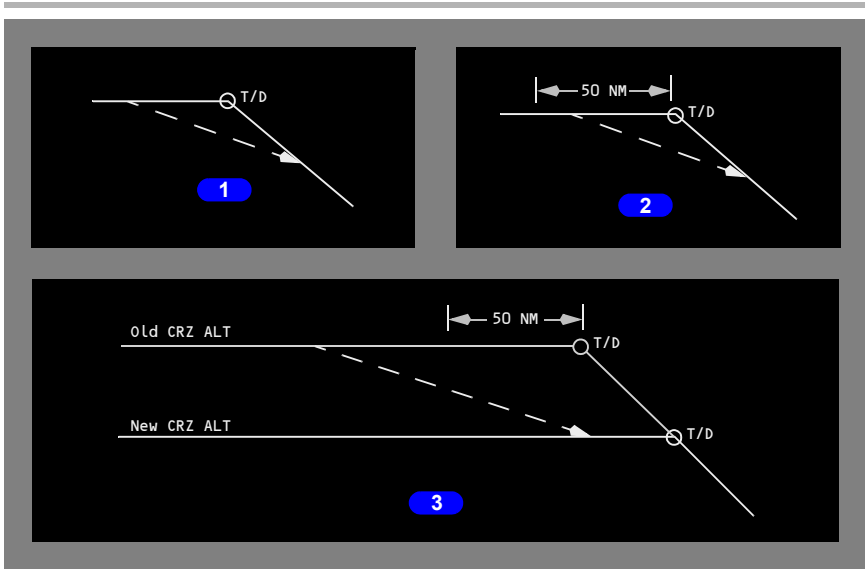

**1 DES NOW**

Use the DES NOW prompt on the DES page. VNAV starts an early descent and captures the idle descent path.

**Note:** When more than 50 NM from the top of descent point, perform a cruise descent rather than a descend now for descent to intermediate altitudes. During cruise descent the FMC computes a new top of descent for the new cruise altitude and accurate destination fuel predictions. Using DES NOW more than 50 NM from the top of descent point can cause a fuel computation error.

**2 Within 50 NM of Top of Descent Point**

Use the MCP altitude selector to start an early descent. Within 50 NM of the top of descent point, VNAV starts an early descent and captures the idle descent path.

**3 More than 50 NM from Top of Descent Point**

Use the MCP altitude selector to start a cruise descent. If the distance from the top of descent is more than 50 NM, VNAV begins a cruise descent to the new cruise altitude and the new T/D is displayed. Monitor the descent profile to ensure the new cruise altitude is reached before T/D.

## Approach

For VFR and nonprecision approaches, VNAV will fly the computed descent path to the E/D point altitude if the MCP altitude is set at or below the E/D point altitude. However, it is the responsibility of the flight crew not to descend below the MDA of the approach being flown until adequate visual contact is achieved.

### "On Approach" Mode

The FMC transitions to "on approach" mode for any of the following conditions:

- an approach procedure selected into the active route from the destination airport ARRIVALS page becomes the active procedure on page 2 of the active Route Page.
- distance to the destination airport is less than 12 nm and the active leg is not part of a procedure
- the MAP (or last waypoint on the approach procedure) is the active waypoint and the distance to that waypoint is less than 25 nm

Transition to the "on approach" FMC mode may be delayed if the flight crew manually inserts, bypasses, or deletes an approach waypoint on the LEGS page.

When the FMC is "on approach", the following features are available:

- the IAS/MACH window can be opened and the command speed can be set while VNAV remains in VNAV PTH descent; VNAV commands the set speed
- the MCP altitude can be set above the airplane altitude for the missed approach. When the MCP altitude setting is at least 300 feet above the current airplane altitude, VNAV continues to command a descent
- VNAV remains in VNAV PTH and follows the descent path unless the airplane accelerates to within 5 knots of the current flap placard and the airplane rises more than 150 feet above the path. In this case, VNAV PTH changes to VNAV SPD

The FMC transitions out of approach under the following conditions:

- the airplane lands
- selecting GA
- the airplane flies beyond the missed approach waypoint

A side step to another approach can be accomplished by selection of a new approach on the ARRIVALS page. An along-course intercept to the next logical approach waypoint in the new approach can be selected on the "INTC CRS TO" line on the LEGS page or by selecting the "XXXXXX INTC>" prompt on the ARRIVALS page.

## Missed Approach

A missed approach is accomplished by selection of either GA switch. The following features are available:

- VNAV (and LNAV) can only be activated when the airplane climbs above 400 feet radio altitude
- all descent altitude constraints below the current airplane altitude are deleted; the waypoints are retained in the active flight plan
- the higher of the altitude in the MCP altitude window or the highest altitude in the missed approach procedure becomes the new cruise altitude
- the FMC transitions from active descent to active climb
- AFDS guidance to fly the published missed approach procedure to the new cruise altitude is active when VNAV (and LNAV) are selected
- when cruise phase is active, the speed target is the most restrictive of 250 knots (below speed transition altitude), best hold speed, or ECON cruise (above speed transition altitude)



## Cruise and Descent Profile (Nonprecision Approach)

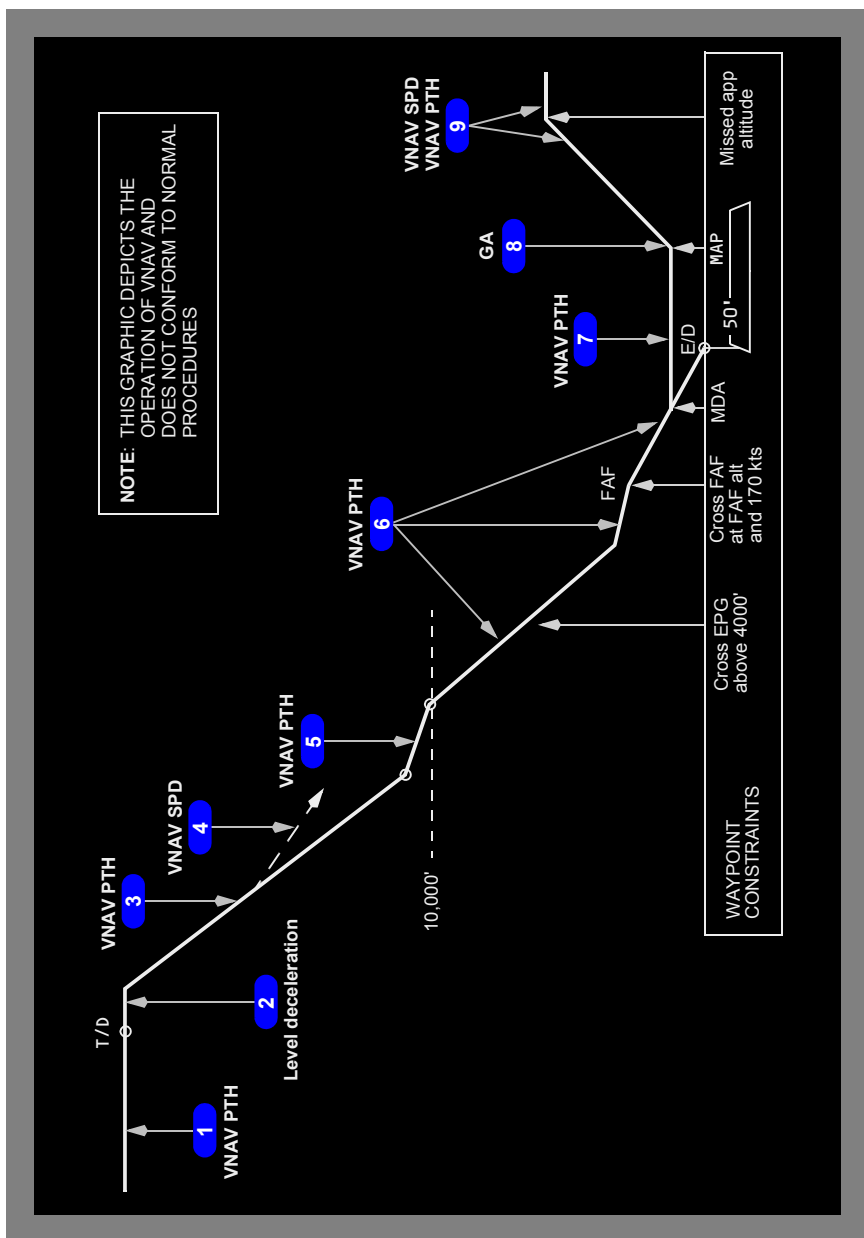

## **1 Cruise**

Before the top of descent, FMC is in cruise mode and uses VNAV PTH and ECON cruise speed.

## **2 Level Descent Phase**

After top of descent, FMC is in descent mode, VNAV decreases airspeed to ECON descent speed, maintains altitude in VNAV PTH.

## **3 Descent**

Upon reaching descent speed, VNAV descends in VNAV PTH at ECON descent speed.

## **4 Speed Limit Protection**

If a tailwind which was not entered on the descent forecast page causes the airplane to accelerate the DRAG REQUIRED scratchpad message will be displayed. If the speedbrakes are not deployed, the pitch mode will change to VNAV SPD and depart the path before the speed reaches the limit.

## **5 Speed Restriction Deceleration**

Before the speed restriction altitude, VNAV decelerates to commanded speed using VNAV PTH.

## **6 Descent and Approach**

When at restricted speed, VNAV descends and starts approach in VNAV PTH at commanded speed.

## **7 Minimum Descent Altitude**

When the MDA is reached with VNAV engaged the airplane will maintain the MDA altitude in VNAV PTH.

If the missed approach point is crossed without selecting GA, VNAV will maintain the missed approach point altitude until GA is selected.

## **8 Go-Around (GA)**

The missed approach go-around is commenced by pushing a Go-Around switch.

Pushing a Go-Around switch

- starts a missed approach
- sets go-around thrust
- and deletes altitude constraints between the airplane and the missed approach waypoint.

## **9 Missed Approach Level Off**

If VNAV is selected during missed approach, VNAV engages in VNAV SPD. At the missed approach altitude the pitch mode changes to VNAV PTH.

## **VNAV Engine Out Operation**

The FMC provides single engine performance guidance which is accessed with the ENG OUT prompt on the CLB or CRZ page. After the engine out page is selected the execute key must be pushed to activate the single engine guidance.

The autothrottle system does not have a single engine capability and the autothrottle must be disconnected after an engine failure. VNAV thrust settings and thrust reference modes must be manually set when operating single engine.

### **Climb (Engine Out Above Engine Out Max Alt)**

When the airplane is above the engine out maximum altitude, selection of the ENG OUT> prompt on the VNAV CLB page creates a modification and displays the applicable engine out driftdown (D/D) performance data to enable the airplane to descend to the engine out maximum altitude. Execution of the modification activates the engine out driftdown function.

### **Cruise (Engine Out Above Engine Out Max Alt)**

Selection of ENG OUT> may also be selected on the CRZ page. If the current altitude is above the engine out maximum altitude, the FMC will command a cruise drift down.

Selection of ENG OUT> may also be accomplished on the XXXX ALTN page in conjunction with a diversion modification.

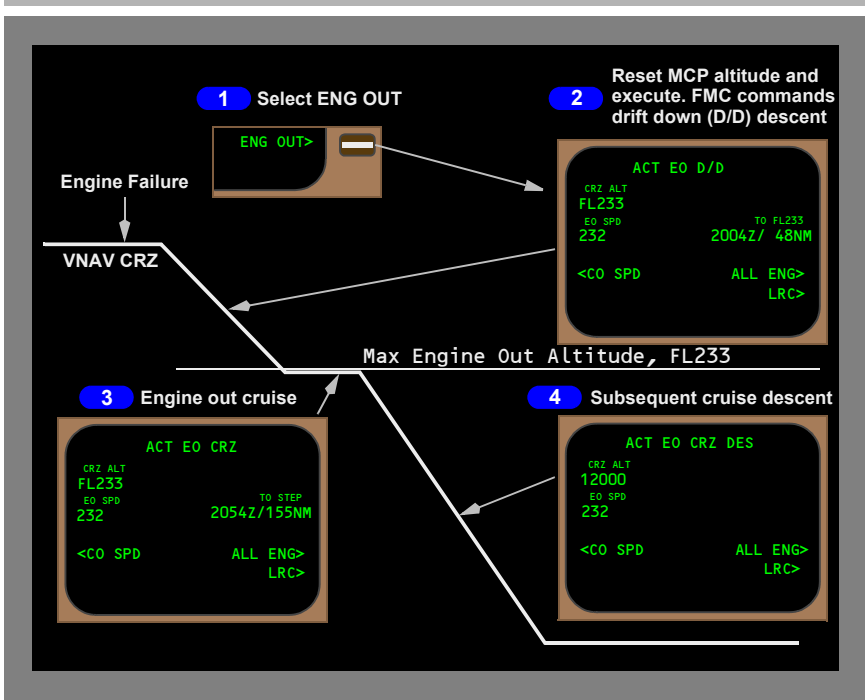

**1 Engine Out Modification**

Select the ENG OUT> prompt on the VNAV CRZ page. Disconnect the autothrottle and set maximum continuous thrust on the operating engine.

Result: The FMC creates a modification and displays the applicable engine out driftdown (D/D) performance data to enable the airplane to descend to the engine out maximum altitude.

**2 Drift Down Execution**

Set the MCP altitude at or below engine out maximum altitude and execute the FMC modification. This assumes clearance is approved to descend slowly to a non-standard altitude; for example, FL233.

Result: VNAV commands a driftdown, and the engine out MAX altitude becomes the cruise altitude at 1L. The descent rate is controlled to maintain at least 300 feet per minute (fpm). Time and distance for the D/D to engine out MAX altitude are displayed at 2R.

The initial drift down speed defaults to EO (minimum drag) speed. Prompts for LRC (long range cruise) and CO SPD (company speed) are displayed or a manual speed entry may be made.

### **3 Engine Out Cruise**

When VNAV captures the engine out maximum altitude, the page changes to the engine out cruise page and the pitch annunciation is VNAV PTH. Predictions for engine out step climb are displayed at 2R.

The VNAV single engine speed can be adjusted to LRC speed, company speed, or a speed entered by the crew. Any change in the single engine speed will change the maximum altitude.

### **4 Subsequent Cruise Descent**

With the FMC in engine out mode more than 50 nm from T/D, set a lower MCP altitude, select the entered altitude from the CDU scratchpad to the CRZ ALT line on the CRZ page and execute.

Result: VNAV cruise descent at approximately 1,250 fpm at the current speed.

When the engine out cruise descent intersects the planned descent profile, descent mode becomes active.

---

## **Data Entry Rules**

### **Altitude Entry**

Altitudes can be entered into the FMC as three digit (XXX), four digit (XXXX), five digit (XXXXX), or flight level (FLXXX) numbers. The FMC displays altitude or flight level entries in the proper form based on the transition altitude. Some data lines further restrict the valid entry forms.

Three digit entries represent altitude or flight levels in increments of 100 feet. Leading zeros are required.

Examples of three digit (XXX, FLXXX) entries with transition altitude = 10,000 feet:

- 800 feet is entered as 008 or FL008; displays as 800
- 1,500 feet is entered as 015 or FL015; displays as 1500
- 11,500 feet is entered as 115 or FL115; displays as FL115
- 25,000 feet is entered as 250 or FL250; displays as FL250.

Four digit entries represent feet, rounded to the nearest ten feet. Leading zeros are required. This form is used when the altitude does not exceed 9,994 feet.

Examples of four digit (XXXX) entries with transition altitude = 18,000 feet:

- 50 feet is entered as 0050; displays as 50
- 835 feet is entered as 0835; displays as 840
- 1,500 feet is entered as 1500; displays as 1500
- 8,500 feet is entered as 8500; displays as 8500
- 9,994 feet is entered as 9994; displays as 9990.

Five digit entries represent feet, rounded to the nearest ten feet. This form is used when the altitude exceeds 9,994 feet

Examples of five (XXXXX) digit entries with transition altitude = 4,000 feet:

- 50 feet is entered as 00050; displays as 50
- 835 feet is entered as 00835; displays as 840
- 1,500 feet is entered as 01500; displays as 1500
- 8,500 feet is entered as 08500; displays as FL085
- 9,995 feet is entered as 09995; displays as FL100
- 11,500 feet is entered as 11500; displays as FL115
- 25,000 feet is entered as 25000; displays as FL250.

Negative altitude entries are allowed to -1000 feet.

## Airspeed Entry

Airspeeds can be entered into the FMC as calibrated airspeed (CAS) or Mach number (M). CAS is entered as three digits (XXX) in knots. Mach numbers are entered as one, two, or three digits following a decimal point.

## Data Pairs

Many CDU pages display data in pairs separated by a slash "/" Examples of these pairs include wind direction/speed and waypoint airspeed/altitude constraints. When entering both values in a pair, the slash is inserted between the values. When it is possible to enter only one value of the pair, the slash may not be required. When entering only the outboard value of a pair, the trailing or leading slash may be entered, but is not required before transferring to the data line. When entering the inboard value of a pair, the trailing or leading slash must be entered before transferring to the data line. Omission of the required slash normally results in an INVALID ENTRY message.

---

**FMC Databases**

The FMC contains three databases:

- performance database
- navigation database
- Airline Modifiable Information (AMI).

The performance database supplies all the necessary performance data to the flight crew. It supplies the FMC with the necessary data to calculate pitch and thrust commands. All necessary data can be shown on the CDU. The database includes:

- airplane drag and engine characteristics
- maximum and optimum altitudes
- maximum and minimum speeds.

The navigation database includes most data usually found on navigation charts. This data can be shown on the CDU or HSI. The database contains:

- the location of VHF navigation aids
- airports
- runways
- other airline selected data, such as SIDs, STARs, approaches, and company routes
- transition altitudes.

The FMC contains two sets of navigation data, each valid for 28 days. Each set corresponds to the usual navigation chart revision cycle. The FMC uses the active data for navigation calculations. The contents of the navigation database are periodically updated and are transferred to the FMC before the expiration date of the active data.

The Airline Modifiable Information (AMI) file contains airline specified data. If the FMC senses a conflict in an AMI value after a new AMI data load, the scratchpad shows the message CHECK AIRLINE POLICY.

---

**Thrust Management**

The autothrottle is controlled by the thrust management computer. When VNAV is engaged, the FMC controls the autothrottle by setting the command speeds and thrust reference modes on the thrust management computer.

When VNAV is not engaged, the thrust management is controlled by the flight crew as part of the AFDS system.

---

---

## Fuel Monitoring

The FMC receives fuel data from the fuel quantity system or from manual entries. Fuel quantity values are shown on the PERF INIT page as calculated (CALC), MANUAL, or SENSED. They are shown on PROGRESS page 2 as TOTALIZER and CALCULATED. TOTALIZER and SENSED values are the same data with different names.

The FMC usually uses the calculated value for performance computations. Before engine start, the calculated value is set to agree with the fuel quantity indicating system value. When the FMC receives a positive fuel flow signal at engine start, the calculated value is independent of the fuel quantity system and decreases at the fuel flow rate.

The FMC will accept a manual entry of the fuel quantity on the PERF INIT page. If a manual fuel quantity is entered, the source of the fuel value on the PERF INIT page changes to MANUAL and the manual value then decreases at the fuel flow rate. When the fuel quantity calculations are based on a manual entry, the FUEL QUANTITY DISAGREE message is inhibited. Deleting a manual entry returns the fuel source on the PERF INIT page to CALC, and the fuel value then becomes the totalizer value at the instant the manual value was deleted, minus the fuel flow.

The calculated value is invalid if fuel flow data is invalid. The FMC uses the fuel quantity indicating system quantity for performance computations. The line title on the PERF INIT page changes to SENSED and is shown as TOTALIZER on PROGRESS page 2. The fuel used by each engine is calculated with its related fuel flow signal. FUEL USED is also shown on PROGRESS page 2.

Fuel used is reset to zero on the ground after flight when electrical power is removed or when the FMC receives a positive fuel flow at the next engine start.

The scratchpad shows the message FUEL DISAGREE–PROG 2 (or FUEL DISAGREE–PROG 2/2) if the FMC calculates a large difference between the total fuel value determined by the fuel quantity indicating system and the total fuel value calculated by the FMC. When the fuel disagree message appears, PROGRESS page 2 is used to select one of those two values for use by the FMC for its fuel calculations for the remainder of the flight.

**Note:** The FUEL DISAGREE message is inhibited if the fuel quantity on the PERF INIT page is entered manually. Deleting a manual entry sets the fuel quantity back to the totalizer value, changes the line title back to CALC and enables the FUEL DISAGREE message.



The FMC continually estimates the fuel at the destination airport if the active route is flown. The CDU message INSUFFICIENT FUEL is shown if the estimate is less than the fuel reserve value entered on the PERF INIT page.

**Note:** FMC calculated fuel predictions assume a clean configuration. Flight with gear or flaps extended cause fuel prediction errors. Fuel predictions are accurate after the gear and flaps are retracted.

---

## Loss of FMC Electrical Power

The FMC must have continuous electrical power to operate. When the electrical power is interrupted and returns, the FMC automatically restarts.

After the restart, the performance data shown on the PERF INIT page must be re-entered. The route previously in use is available but must be reactivated.

The flight crew must modify the active waypoint to engage LNAV. Select the applicable active waypoint and proceed direct or intercept a course to the waypoint.

---

## FMC Failure

### Single FMC Failure

The scratchpad shows the message SINGLE FMC OPERATION after loss of a single FMC. The EICAS advisory message L (or R) FMC FAIL is displayed and the HSI MAP flag is displayed on the side with the failed FMC.

The crew member on the side with the failed FMC selects the opposite FMC with the NAV selector to regain CDU access to the operating FMC and HSI map displays. LNAV and VNAV, if engaged, stay engaged and all flight plan and performance data is kept.

**Note:** If the MENU page and the scratchpad message TIMEOUT RESELECT is shown, the FMC is no longer connected to the CDU. Use the <FMC prompt on the MENU page to connect the CDU to the FMC.

### Dual FMC Failure

In the unlikely event that both FMCs fail the EICAS advisory messages L FMC FAIL and R FMC FAIL are displayed. LNAV and VNAV are not available.

Selecting CDU-L or CDU-R with the NAV selector on the instrument select panel provides route data to the HSIs. Alternate navigation using the CDUs is discussed in Section 50 of this chapter.

**Note:** The CDUs display the MENU page but the <FMC prompt is not shown in line 1. Push the LEGS function key to show the IRS LEGS page and the PROG key to show the IRS PROGRESS page.

## **FMC Resets**

A software reset may occur in dual or single FMC operation. When a software reset occurs, the active route becomes inactive, the performance data is erased, and LNAV and VNAV modes (if engaged) fail. There is not an EICAS message or an FMC scratchpad message to alert the crew of a reset condition. To regain FMC operation, activate and execute the flight plan, reenter the necessary performance data, and reengage LNAV and VNAV.

---

**Introduction**

FMC preflight is required before flight.

Completion of the FMC preflight requires data entry in all minimum required data locations. Additional entry of optional preflight data optimizes FMC accuracy.

---

**Preflight Page Sequence**

The usual FMC power-up page is the identification page. Preflight flow continues in this sequence:

- identification (IDENT) page
- position initialization (POS INIT) page
- ROUTE page
- DEPARTURES page (no automatic prompt)
- performance initialization (PERF INIT) page
- takeoff reference (TAKEOFF REF) page.

Some of these pages are also used in flight.



Route discontinuities are removed and the route is modified on the ROUTE and RTE LEGS pages. Speed/altitude restrictions are entered and removed on the RTE LEGS page. The RTE LEGS page is described in the FMC Cruise section of this chapter.

Alternate airports are added on the ALTN page. The ALTN page is described in the FMC Descent/Approach section of this chapter.

Waypoint, navaid, airport, and runway data is referenced on the REF NAV DATA page. The REF NAV DATA page is described in the FMC Cruise section of this chapter.

VNAV performance is improved if forecast winds and temperatures are entered during the preflight.

Wind and temperature data for specific waypoints is entered on the WIND page. The WIND page is described in the FMC Cruise section of this chapter.

### Preflight Pages – Part 1

The preflight pages are presented in the sequence used during a typical preflight.

#### Initialization/Reference Index Page

The initialization/reference index page allows manual selection of several FMC pages. It gives access to most of the pages used during preflight.

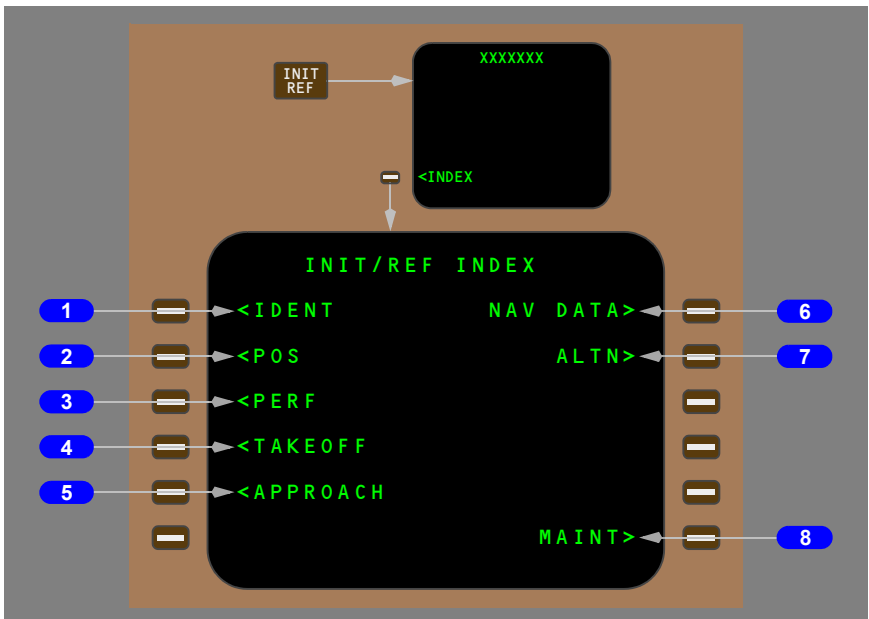

**1 Identification (IDENT)**

The IDENT page is the first page in the preflight sequence.

**2 Position (POS)**

The POS INIT page is used for input of reference position for inertial alignment.

**3 Performance (PERF)**

The PERF INIT page is used for initialization of data required for VNAV operations and performance predictions.

**4 TAKEOFF**

The TAKEOFF REF page is used to enter takeoff reference data and V speeds.

**5 APPROACH**

The APPROACH REF page is used for entry of the approach VREF speed.

**6 Navigation (NAV) DATA**

The REF NAV DATA page is used to access data on waypoints, navaids, airports, and runways. The REF NAV DATA page is accessible only from this page.

**7 Alternate (ALTN)**

The ALTN page is used for alternate airport planning and diversions.

**8 Maintenance (MAINT)**

For maintenance use only; displays maintenance pages.

## Identification Page

Most of the data on this page is for flight crew verification. The active navigation database can be selected.

The flight crew verifies FMC data, selects the current navigation database, and checks drag and fuel flow factors on the identification page.

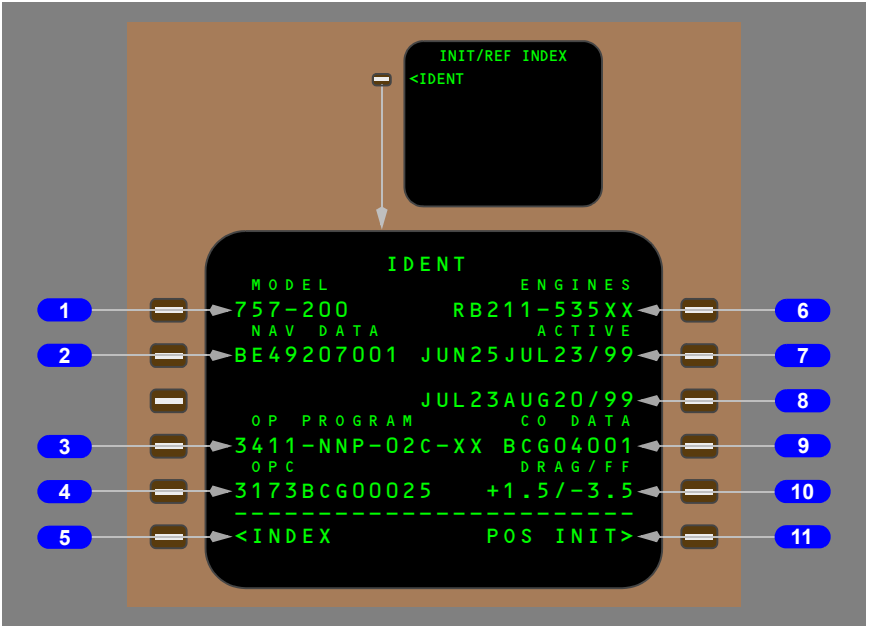

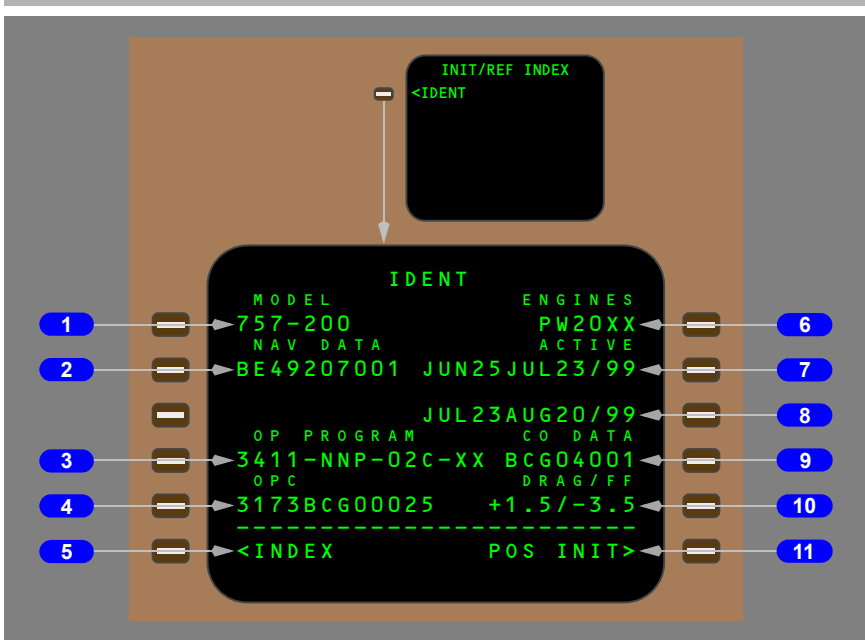

**1 MODEL**

Displays the airplane model from the FMC performance database.

**2 Navigation (NAV) DATA**

Displays the navigation database identifier.

**3 Operating (OP) PROGRAM**

Displays the operating program identifier.

**4 Operating Program Configuration (OPC) Part Number**

Displays the Operational Program Configuration part number.

**5 INDEX**

Push – displays the INIT/REF INDEX page.

**6 ENGINES**

Displays the engine model from the FMC performance database.



**7 ACTIVE**

Displays range of effective dates for the active navigation database.

The active navigation database can be replaced with the inactive database while on the ground. Changing the navigation database removes all previously entered route data.

**8 Inactive Date Range**

Displays range of effective dates for the inactive navigation database. May be line selected to the scratchpad and inserted to the ACTIVE line while on the ground.

**9 Company (CO) DATA**

Displays the last eight characters of the Airline Modifiable Information (AMI) part number.

**10 DRAG/Fuel Flow (FF) Factors**

Displays the airplane drag and fuel flow correction factors.

For maintenance use only.

**11 Position Initialization (POS INIT)**

Push – displays the POS INIT page.

### **Position Initialization Page**

The position initialization page allows entry of airplane present position for IRS alignment. This page is also used to enter the heading when an IRS is in the ATT mode.

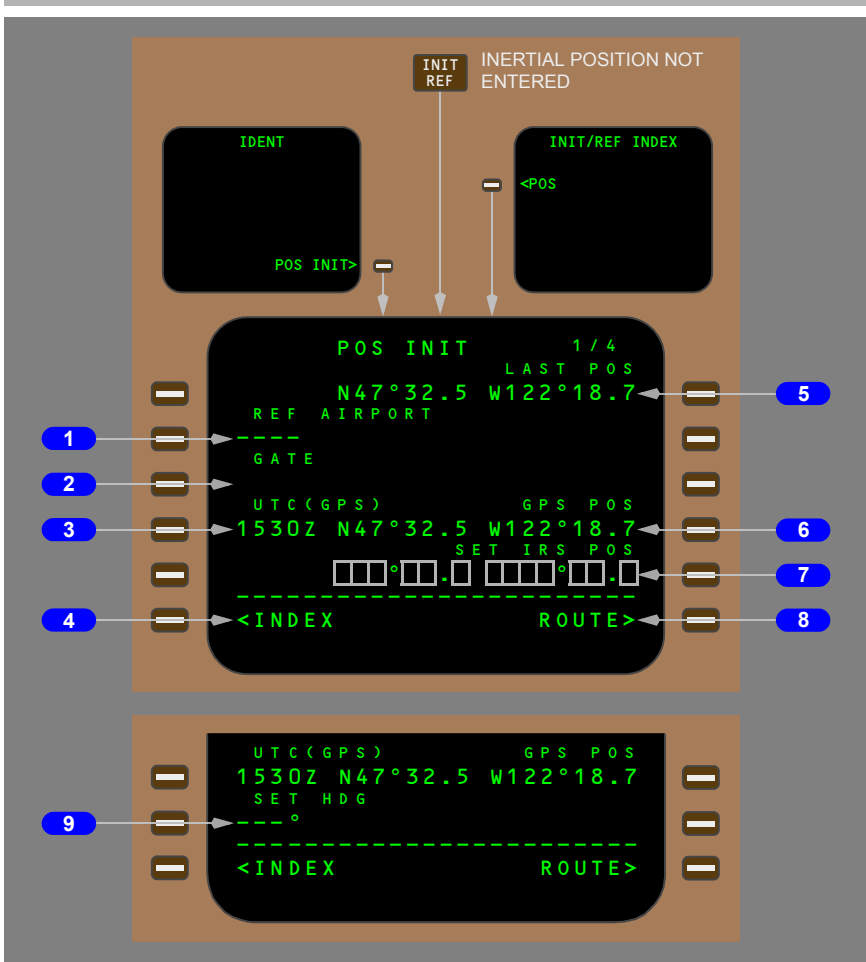

**1 Reference Airport (REF AIRPORT)**

Entry of the reference airport displays the airport latitude/longitude.

Optional entry.

Valid entries are ICAO four letter airport identifiers.

Removes previous GATE entry.

Entry blanks when airborne.

**2 GATE**

The gate entry allows further refinement of the latitude/longitude position.

Optional entry after reference airport entered.

Valid entry is a gate number at the reference airport.

Displays the latitude and longitude of the reference airport gate.

Changes to dashes when a new reference airport is entered.

Entry blanks when airborne.

### **3 Coordinated Universal Time (UTC)**

UTC (GPS) – displays time from GPS.

UTC (MAN) –

- displays time from captain's clock when operative; otherwise, displays time from first officer's clock
- hours set by entering desired hour reference
- minutes set by resetting appropriate pilot's clock.

### **4 INDEX**

Push – displays the INIT/REF INDEX page.

### **5 Last Position (LAST POS)**

Displays the last FMC calculated position.

### **6 GPS Position (GPS POS)**

Displays the GPS present position. During preflight, the GPS POS may not display due to satellite availability, performance, or unfavorable geometry.

### **7 Set IRS Position (SET IRS POS)**

The set inertial position entry is required to initialize the IRS. Select the most accurate latitude/longitude from LAST POS, REF AIRPORT, GATE, GPS POS, or a manual entry to initialize the IRS.

If an entry is not made before the IRS completes the initial alignment, the scratchpad message ENTER IRS POSITION is displayed.

If the manually entered position fails the IRS internal check, the scratchpad message ENTER IRS POSITION is displayed.

The manually entered position is also compared with the FMC origin airport position. If the entered position is not within 6 NM of the FMC origin airport position, the scratchpad message IRS POS/ORIGIN DISAGREE is displayed.

Boxes display within one minute of IRS power-up.

Blanks when the IRS changes from the alignment to the navigation mode.

**8 ROUTE**

Push – displays the ROUTE page.

**9 Set Heading (SET HDG)**

Dashes display when an IRS selector is placed in the ATT position.

Enter magnetic heading to initialize the IRS in the ATT mode to provide headings. Heading should be updated regularly if extended operation in ATT is necessary.

Valid entry is 0 to 360 (0 or 360 displays as 0°).

## **Position Reference Pages**

The three position reference pages are not part of a normal preflight. They are presented here in a logical sequence because they are accessed from the position initialization page.

### **Position Reference Page 2/4**

Position reference page 2 displays positions calculated by the FMC, IRS, GPS, and radio navigation receivers. The FMC position can be updated to IRS, GPS, or radio position on this page.

Positions are displayed as the latitude/longitude calculated by the individual systems. When BRG/DIST is selected the IRS, GPS, and radio positions are shown as bearing and distance from the FMC position.

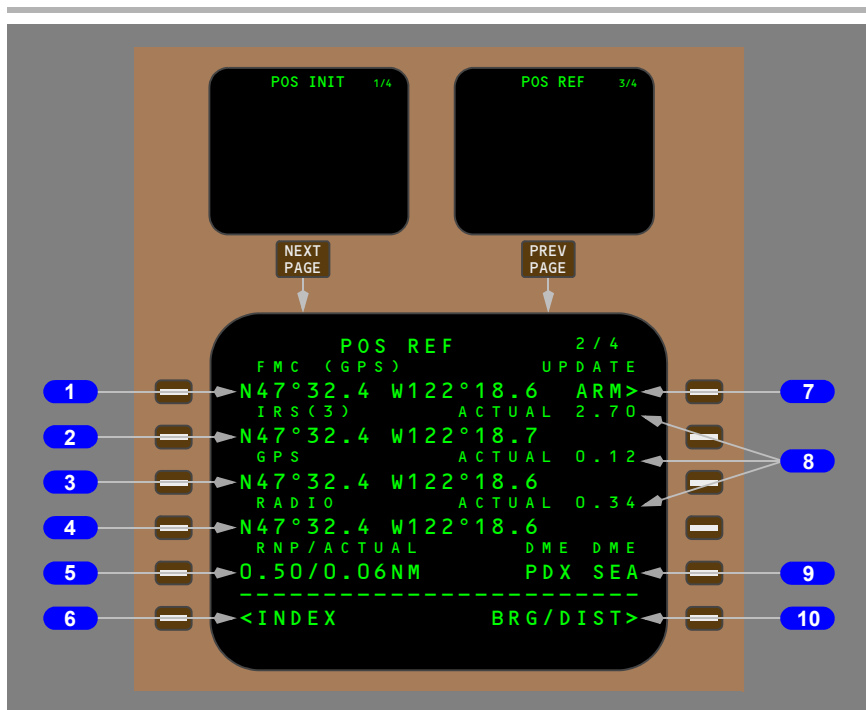

### 1 FMC Position and Source

The source used by the active FMC for position data is displayed next to the FMC line title. In the example, the FMC uses LGPS for position data.

Displays the FMC calculated latitude/longitude.

Identifies the source for calculating the FMC position:

- GPS – position calculated from GPS and inertial position data
- IRS – position calculated from inertial position data only
- RADIO – position calculated from navigation radio and inertial position data
- LOC–GPS – position is calculated from localizer, GPS and inertial data
- LOC–RADIO – position is calculated from localizer, navigation radio and inertial data
- LOC – position is calculated from localizer and inertial data.

## 2 IRS

Displays latitude/longitude position or the bearing and distance from the FMC position determined by the IRS. If the displayed position is derived from all three IRSs, (3) is displayed. If the position is from a single IRS then (L), (C), or (R) is displayed to indicate which IRS position is displayed.

## 3 GPS

Displays latitude/longitude position or the bearing and distance from the FMC position determined by the GPS.

## 4 RADIO

After airborne, displays latitude/longitude position or the bearing and distance from the FMC position determined by navigation radios.

## 5 Required Navigation Performance and Actual Navigation Performance (RNP /ACTUAL)

Displays the RNP and actual navigational performance (ACTUAL) of the FMC. Default RNP is in small font.

Valid RNP entries are in the range 0.01 to 99.9. ACTUAL entry not allowed.

When ACTUAL exceeds RNP, EICAS displays the UNABLE RNP message.

**Note:** The FMC stops GPS updating if GPS data accuracy degrades due to satellite availability or unfavorable geometry. Subsequently, the FMC receives updates from another system.

## 6 INDEX

Push – displays the INIT/REF INDEX page.

## 7 UPDATE ARM

Push –

- arms FMC position update function
- changes prompt to ARMED
- adds NOW prompts to right side of INERTIAL, GPS, and RADIO lines.

Push a NOW prompt key to update FMC position to the selected source.

## 8 ACTUAL

Displays actual navigation performance (ANP) of the IRS, GPS and navigation radios.

**9 Radio Update Station(s)/Mode**

Displays radio station identifiers.

Position update mode is indicated in the line title:

- DME DME
- VOR DME

Line and title are blank when no radio position is computed.

**10 Bearing/Distance (BRG/DIST) or Latitude/Longitude (LAT/LON)**

Push – alternates position data format between bearing/distance or latitude/longitude.

The page illustration is shown in the latitude/longitude display format.

Latitude/longitude format displays are actual position. Bearing/distance display is relative to the FMC position.

**Position Reference Page 3/4**

On position reference page 3, the flight crew can observe the calculated positions from the left and right GPS receivers and the left and right FMC calculations. This page also allows the flight crew to enable or disable GPS position updates.

This page can display the bearing/distance or latitude/longitude format. The bearing/distance format displays the positions relative to the active FMC position on the POS REF 2/4 page.

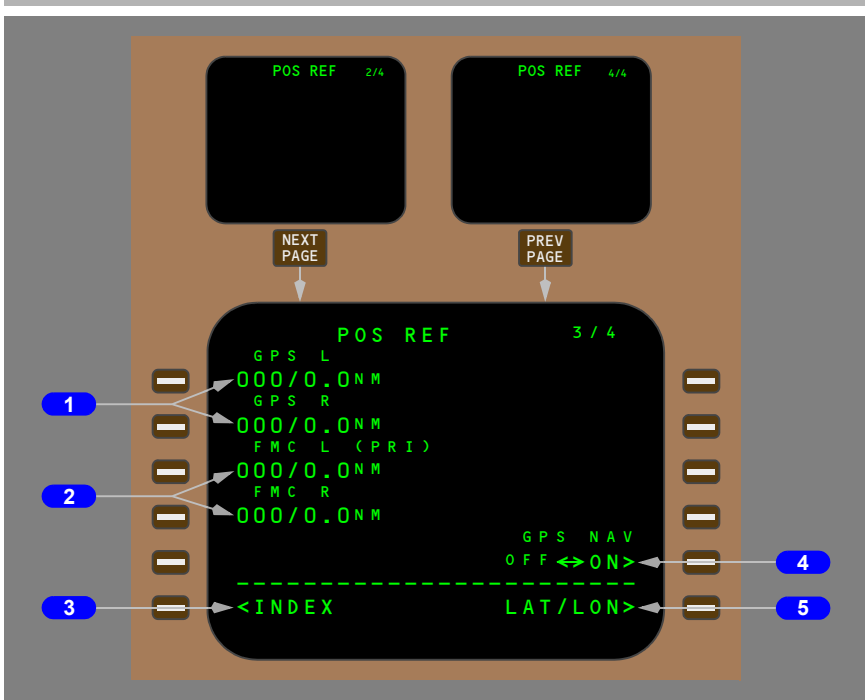

**1 GPS Left (L) and GPS Right (R)**

Displays the left and right GPS positions.

**2 FMC Left (L) and FMC Right (R)**

Displays the left and right FMC calculated position.

Primary (PRI) is displayed in line title of the FMC that is the navigation master.

**3 INDEX**

Push – displays the INIT/REF INDEX page.

**4 GPS Navigation (NAV)**

Push – alternately selects GPS NAV ON (enabled) and OFF (disabled).

OFF – GPS position data is not available to the FMC. OFF displays in large letters; ON displays in small letters.

ON – GPS position data is available to the FMC. ON displays in large letters; OFF displays in small letters.

**Note:** When the engines are shut down after flight GPS NAV is set to ON.



**5 Latitude/Longitude (LAT/LON) or Bearing/Distance (BRG/DIST)**

Push – alternately changes the display of position data on POS REF 2/4, 3/4, and 4/4 to latitude/longitude format or bearing/distance format.

The page illustration is shown in the bearing/distance display mode.

**Position Reference Page 4/4**

On position reference page 4, the calculated positions and ground speeds from the left, center and right IRS are displayed. Positions can be displayed in the bearing/distance or latitude/longitude format.

**1 IRS L, C, and R**

Displays the position of the Left, Center, and Right IRS. Positions can be displayed in latitude longitude or as bearing and distances from the FMC position.

**2 INDEX**

Push – displays the INIT/REF INDEX page.

**3 Ground Speed (GS)**

Displays the ground speed calculated by each IRS. The displayed values are frozen when the engines are shut down after flight until power is removed.

**4 Latitude/Longitude (LAT/LON) or Bearing/Distance (BRG/DIST)**

Push – alternately changes the displayed position between latitude/longitude format and bearing/distance format. When the display is in the bearing/distance format the prompt displays LAT/LON>.

**Route Page**

Two routes (RTE 1 and RTE 2) can be stored and displayed in air traffic control format. The first route page displays origin and destination data. Subsequent route pages display route segments between waypoints or fixes. Having two routes allows management of alternate or future routes while leaving the active route unmodified. RTE 2 has an identical page structure as RTE 1.

**Route Page 1/X**

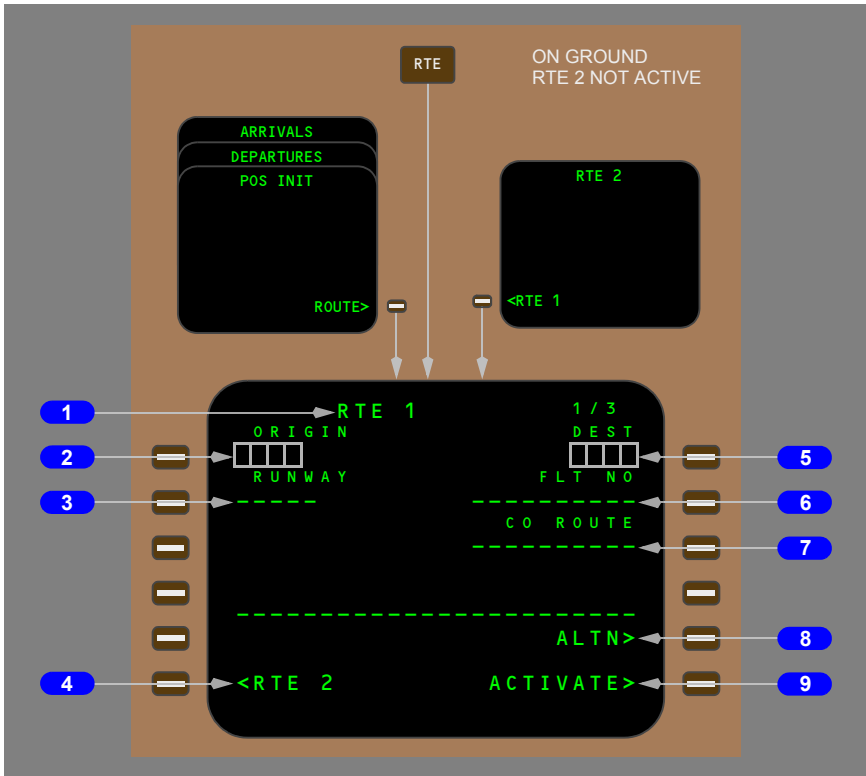

**1 Page Title**

Preceded by ACT when the route is active, and by MOD when the route is modified and the change is not executed.

Multiple route pages are indicated by the page sequence number to the right of the title. The minimum number of route pages is 2.

## **2 ORIGIN**

Entry:

- must be a valid ICAO identifier in the navigation database
- made automatically when a company route is entered
- enables direct selection of departure and arrival procedures
- required for route activation
- inhibited in-flight for active route.

Entry on the ground deletes existing route.

## **3 RUNWAY**

Enter the applicable runway for the origin airport. Runway must be in the navigation database.

Entry:

- is optional
- causes MOD to display in the title if route is active
- can be selected on the DEPARTURES page
- can be included in company route.

The runway is deleted after the first waypoint is crossed.

## **4 Route (RTE) 2**

Push – displays the RTE 2 page 1/x.

Allows access to an inactive route for entry, modification or activation.

Inactive route modifications:

- do not alter the active route
- do not change the inactive RTE page title.

Prompt changes to RTE 1 when RTE 2 is displayed.

## **5 Destination (DEST)**

Entry:

- must be a valid ICAO identifier in the navigation database
- made automatically when a company route is entered
- required for route activation
- displays MOD in page title if entered in an active route.

## **6 Flight Number (FLT NO)**

Enter the company flight number.

Entry:

- optional for activation of the route
- limited to 10 characters
- may be entered by the flight crew or uplinked
- included in the PROGRESS page title
- propagated to RTE 2 page
- deleted at flight completion.

## **7 Company Route (CO ROUTE)**

A company route can be called from the navigation database by entering the route identifier. The data supplied with a company route can include origin and destination airports, departure runway, SID and STAR, and the route of flight. All company route data is automatically entered when the route identifier is entered.

An entry is optional for activation of the route.

Valid entry is any company route name. If the name is not contained in the navigation database, the entry is allowed and the scratchpad message NOT IN DATABASE is displayed.

Entry of a new company route replaces the previous route.

In-flight entry is inhibited for the active route.

## **8 Alternate (ALTN)**

Push – displays the ALTN page.

## **9 ACTIVATE**

Push the ACTIVATE key to arm the route and illuminate the execute light. When the EXEC key is pushed, the route becomes active, ACT is displayed in the title, and the ACTIVATE prompt is replaced with the next required preflight page prompt.

Activation of a route is required for completion of the preflight.

ACTIVATE is always displayed on the inactive route pages.

After route activation, the ACTIVATE prompt is replaced by:

- PERF INIT, when the required performance data is incomplete, or
- TAKEOFF when the required performance data is complete.

**More Route Page Prompts for an Active Route****1 PRINT**

Push – prints the active route if printer is available.

**2 Route Copy (RTE COPY)**

Push – copies the entire active route into the inactive route.

Displayed only on the active route page.

Displays COMPLETE after the route is copied.

**Route Page 2/X**

The subsequent route pages 2/X through X/X, display route segments in air traffic control format. Route segments are defined as direct routing, airways, or procedures with start and end points such as waypoints, fixes, nav aids, airports, or runways. More waypoints for each route segment are shown on the RTE LEGS page.



## 1 VIA

The VIA column displays the route segment to the waypoint or termination in the TO column. Enter the path which describes the route segment between the previous waypoint and the segment termination.

Enter an airway in the VIA column and boxes display in the TO column.

Valid entries can also include procedures or DIRECT. Procedures are usually entered through selections on DEPARTURES and ARRIVALS pages. DIRECT is usually entered as a result of entering a TO waypoint first.

Valid airways must:

- contain the previous TO waypoint, or
- intersect the previous VIA route segment.

Dashes change to DIRECT if the TO waypoint is entered first.

Dashes are displayed for the first VIA beyond the end of the route.

Invalid VIA entries result in the scratchpad message INVALID ENTRY.

Invalid VIA entries are:

- airways routes which do not contain the TO waypoint of the previous line or
- airways that do not intersect the previous airway
- airways or company routes that are not in the navigation database.

The start and end waypoints determine whether the entered airway is valid. The route segment must contain the waypoint entered in the TO position. The TO waypoint of the previous route segment must be the same as the start point of the next route segment or a route discontinuity is created between the segments.

Entry of a SID or transition enters the VIA and TO data for the route segments of the SID. A SID links to the next route segment if the final SID waypoint is part of the route segment.

Entering an airway on the first VIA line of page 2 initiates an airway intercept and boxes are displayed in the first TO line. When a waypoint is entered in the boxes the airway and waypoint are moved down to the second line. The FMC enters a waypoint in the first TO line which is the first waypoint on the airway segment closest to the airplane position.

Entering two intersecting airways in successive VIA lines without a TO waypoint causes the FMC to create an airway intersection waypoint to change from one airway to the next. The FMC created waypoint is displayed as the TO waypoint for the first airway.

LACRE3.VAMPS is an example of a SID selection made on the DEPARTURES page.

V2 and V336 are examples of airway entries.

APP TRANS is an example of a STAR selection made on the APPROACH page.

ILS32R is an example of an approach selection made on the APPROACH page.

## **2 TO**

Enter the end point of the route segment specified by the VIA entry.

Entry of a waypoint in the TO column without first entering a VIA airway displays DIRECT in the VIA column.

Boxes indicate data input is required to complete the route segment definition.

Valid waypoint entries for a DIRECT route segment are any valid waypoint, fix, navaid, airport, or runway.

Valid waypoint entries for airways are waypoints or fixes on the airway.

Dashes display on the first TO waypoint after the end of the route.

## Preflight Pages – Part 2

### Departure/Arrival Index Page

The departure and arrival index page is used to select the departure or arrival page for the origin and destination airports for each route. The index also allows reference to departure or arrival data for any other airport in the navigation database.

Departure and arrival prompts are available for the origin airport. Destination airports have only arrival prompts.

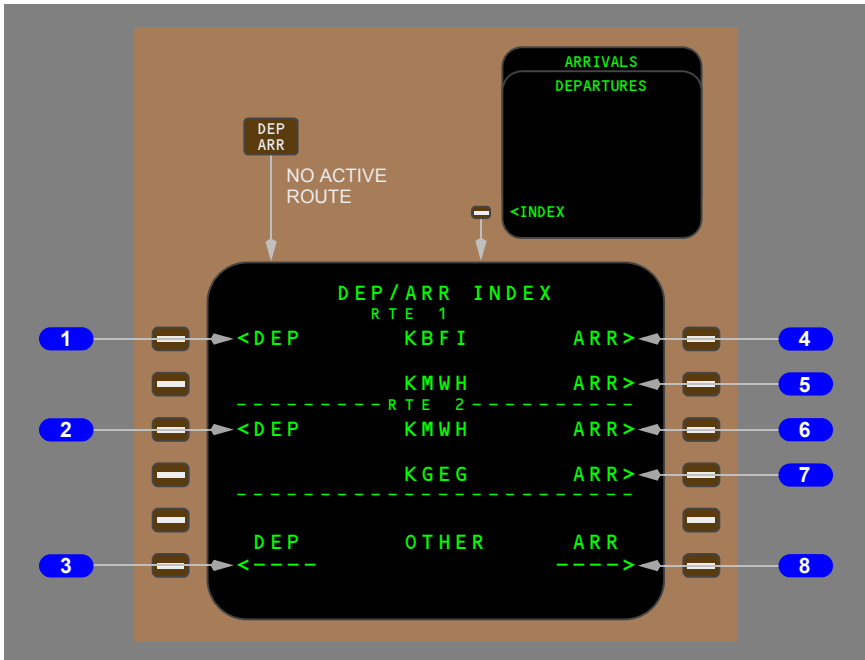

#### 1 Departure (DEP) – Route 1

Push – displays the departure page for route 1 origin airport.

#### 2 Departure (DEP) – Route 2

Push – displays the departure page for route 2 origin airport.

#### 3 Departure (DEP) – Other

Displays the departure page for the airport entered into this line through the scratchpad.



DEP prompt for OTHER allow display of departure data about airports that are not an origin or destination. The data can be viewed but cannot be selected because the airport is not on the route.

**4 Arrival (ARR) – Route 1 Origin**

Push – displays the arrival page for route 1 origin airport. Origin airport arrivals selection is used during a turn-back situation.

**5 Arrival (ARR) – Route 1 Destination**

Push – displays the arrival page for route 1 destination airport.

**6 Arrival (ARR) – Route 2 Origin**

Push – displays the arrival page for route 2 origin airport. Origin airport arrivals selection is used during a turn-back situation.

**7 Arrival (ARR) – Route 2 Destination**

Push – displays the arrival page for route 2 destination airport.

**8 Arrival (ARR) – Other**

Displays the arrival page for the airport entered in this line through the scratchpad. ARR prompt for OTHER allow display of arrival data about airports that are not an origin or destination. The data can be viewed but cannot be selected because the airport is not on the route.

## Departures Page

The departures page is used to select the departure runway, SID, and transition for the route origin airport.

The departures page for the inactive route displays when the DEP ARR function key is pushed with an inactive RTE or RTE LEGS page is displayed.

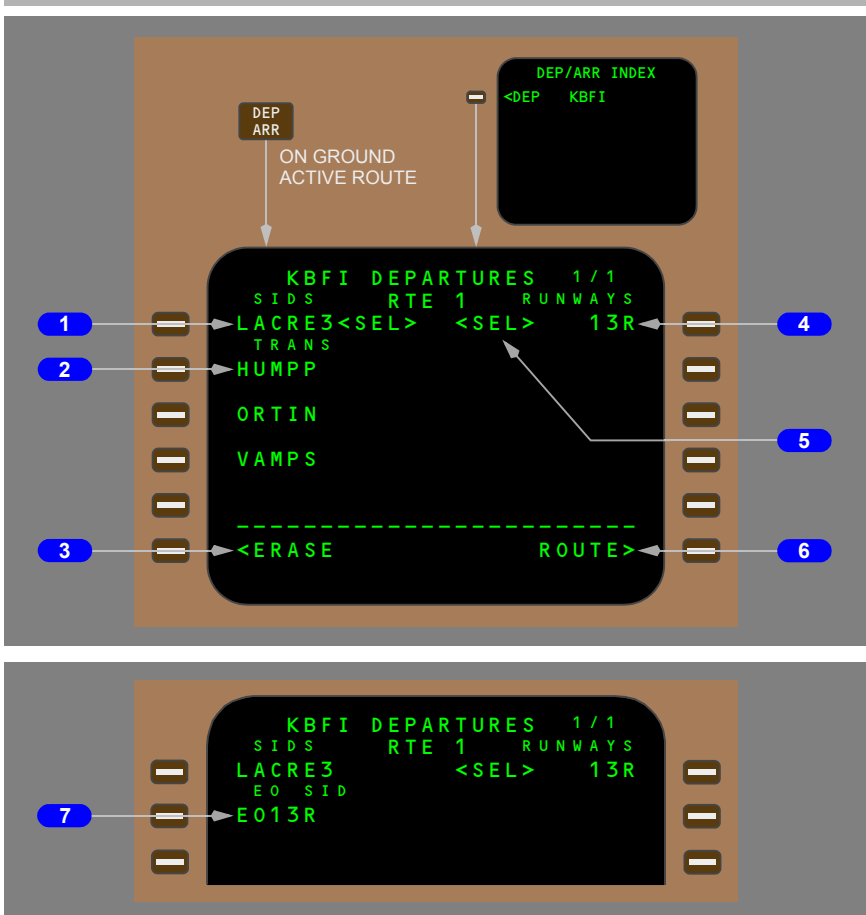

**1 Standard Instrument Departures (SIDS)**

Displays a list of SIDS for the airport.

Push –

- selects SID for use in the route
- other SIDS no longer display and transitions for the selected SID display
- runways for selected SID remain and others no longer display.

**2 Transitions (TRANS)**

Displays transitions compatible with the selected SID.

Push –

- selects transition for entry in the route
- other transitions no longer display.

### **3 ERASE or INDEX**

Erase displays when a route modification is pending. INDEX displays when no route modification is pending.

ERASE push – removes selections not executed and displays the entire departure page. Other vertical or lateral modifications will be erased also.

INDEX push – displays the DEP/ARR INDEX page.

### **4 RUNWAYS**

Displays a list of runways for the selected airport.

The runway selected on the RTE 1/X page displays as <SEL> or <ACT>.

Push –

- selects runway for use in the route. All other runways no longer display
- SID's associated with selected runway remain, all others no longer display
- subsequent change of a runway deletes departure procedures previously selected.

### **5 <SEL>, <ACT>**

Selecting an option displays <SEL> inboard of the option and creates a route modification. After executing the modification, <SEL> becomes <ACT>.

Executing a modification or leaving the page and returning displays all options and the <SEL> or <ACT> prompts.

### **6 ROUTE**

Push – displays the related RTE page.

### **7 Engine Out Standard Instrument Departure (EO SID)**

EO SID's are airline designed procedures for specific runways. When a runway is selected the EO SID is listed after the other SID's associated with that runway. If no EO SID exists for the selected runway, NONE is displayed.

PUSH – on the ground, selects the EO SID as a route modification for review. The modification should be erased after the review is complete.

If an engine failure occurs after takeoff before the flaps are retracted, the EO SID will be automatically loaded as a route modification to be executed or erased.

## Navigation Radio Page

VOR navigation radios are normally autotuned by the FMC. The NAV RADIO page displays the tuned VOR frequencies, identifiers, tuning status and current radial for both VOR receivers. The VORs can be remotely tuned from this page.

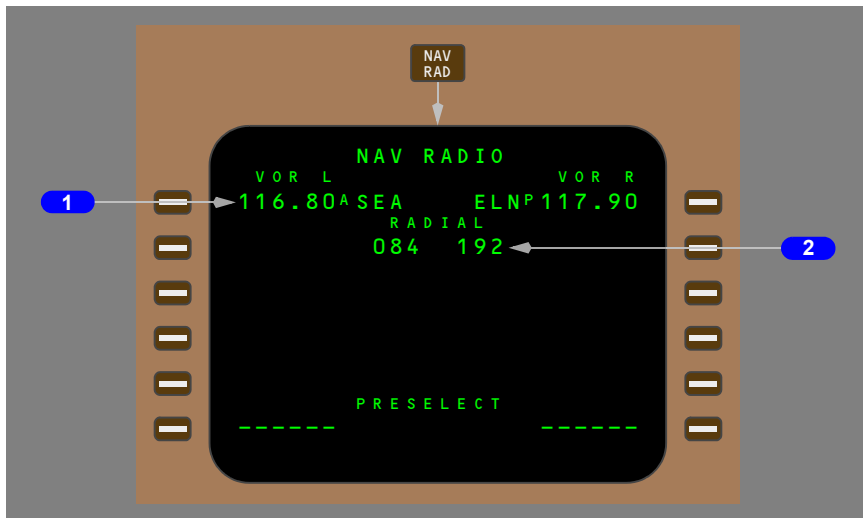

### 1 VOR Frequency and Tune Status

The tuning status is displayed adjacent to left and right VOR frequencies. Entry of a frequency or identifier remotely tunes a VOR. The FMC autotunes VORs and their related DMEs for procedure flying and radio positions. The tuning status displays are:

- A (autotuning) – FMC selects a navaid for best position orientation
- P (procedure autotuning) – FMC selects navaids for approach or departure procedure guidance
- R (remote tuning) – VOR frequency or identifier has been entered by the flight crew on the NAV RADIO page.
- M (manual) – VOR is manual-tuned using the VOR control panels on the glareshield. Manual-tuning takes priority over FMC autotuning.

Valid entries:

- VOR or non-ILS DME identifier
- VOR frequency (XXX.X or XXX.XX)

The identifier and frequencies are green and tuning status is white.

### 2 RADIAL

Displays the current radial from the left and right VOR stations to the airplane.

## Performance Initialization Page

The performance initialization page allows the entry of airplane and route data to initialize performance calculations. This data is required for VNAV operation.

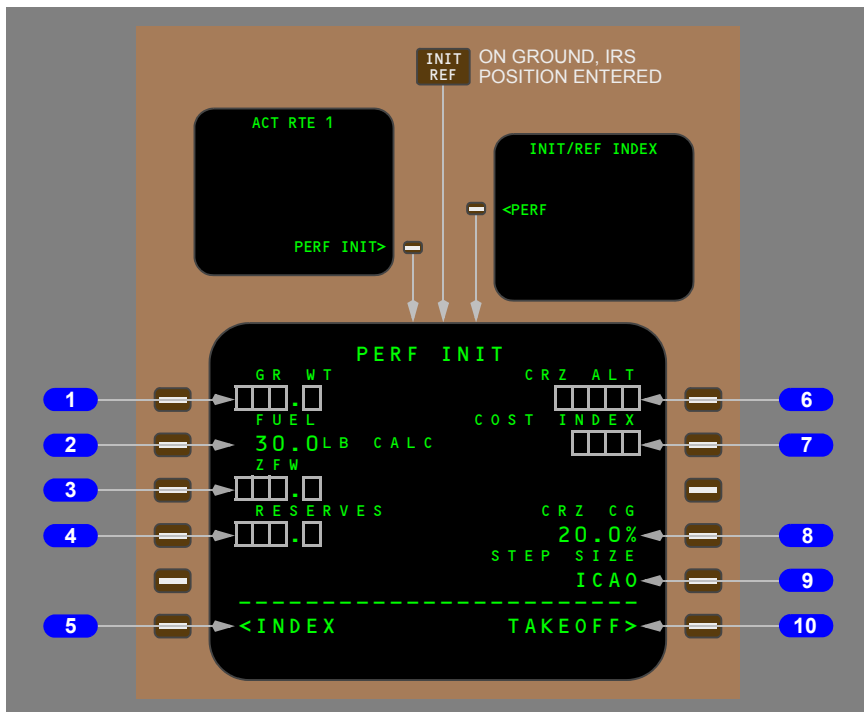

### 1 Gross Weight (GR WT)

Airplane gross weight can be entered by the flight crew or calculated by the FMC after entry of zero fuel weight.

Valid entry is thousands of pounds with a decimal (hundreds) optional.

Entering the zero fuel weight first displays calculated gross weight.

Entry of a value after takeoff speeds are selected removes the speeds and displays the scratchpad message TAKEOFF SPEEDS DELETED.

## **2 FUEL**

Fuel on board displays when the fuel totalizer calculations are valid. The source for the display is included in the line:

- SENSED – fuel quantity is from the totalizer.
- CALC (calculated) – fuel quantity is from FMC calculations. Manual entry is possible
- MANUAL – fuel quantity has been manually entered. Manual entries blank the totalizer display on PROGRESS page 2.

Valid entry is thousands of pounds with a decimal (hundreds) optional.

Only manual entries can be deleted. Deleting the manual entry resets the fuel value to the existing totalizer value, which then decreases at the fuel flow rate, and the fuel source returns to CALC.

## **3 Zero Fuel Weight (ZFW)**

Normally, ZFW is entered from the airplane dispatch papers and the FMC calculates the airplane gross weight.

Valid entry is thousands of pounds with a decimal (hundreds) optional.

Calculated zero fuel weight displays when airplane gross weight is entered first and fuel on board is valid.

Entry of a value after takeoff speeds are selected removes the speeds and displays the scratchpad message TAKEOFF SPEEDS DELETED.

## **4 RESERVES**

Valid entry is thousands of pounds with a decimal (hundreds) optional.

## **5 INDEX**

Push – displays the INIT/REF INDEX page.

## **6 Cruise Altitude (CRZ ALT)**

Cruise altitude can be entered by the flight crew or from a company route.

Entered value is displayed on the CLB and CRZ pages.

## **7 COST INDEX**

Cost index is used to calculate ECON climb, cruise, and descent speeds. Larger values increase the ECON cruise speed. Entering zero results in maximum range airspeed and minimum trip fuel. Cost index can be entered by the flight crew or from a company route.

Valid entries are 0 to 9999.

**8 Cruise Center of Gravity (CRZ CG)**

Used by FMC to compute maximum altitude and maneuver margin to buffet.

Displays default center of gravity in small font.

A flight crew entered value displays in large font.

**9 STEP SIZE**

Displays the climb altitude increment used for planning the optimum climb profile.

Default value is ICAO which provides a 2000 foot step below FL290 and a 4000 foot step above FL290.

Valid manual entries are 0 to 9000 in 1000 foot increments.

In-flight entries are inhibited. In-flight step size changes are made on the CRZ page.

For a non-zero entry, performance predictions are based on step climbs at optimum points. For a zero entry, performance predictions are based on a constant CRZ ALT.

**10 TAKEOFF**

Push – displays the TAKEOFF REF page.

**Takeoff Reference Page**

The takeoff reference page allows the input of the final performance data required for takeoff. Entries on the takeoff reference page complete the normal FMC preflight. If any required preflight data has been omitted, prompts are displayed to access the page where data is missing.

Takeoff Reference Page

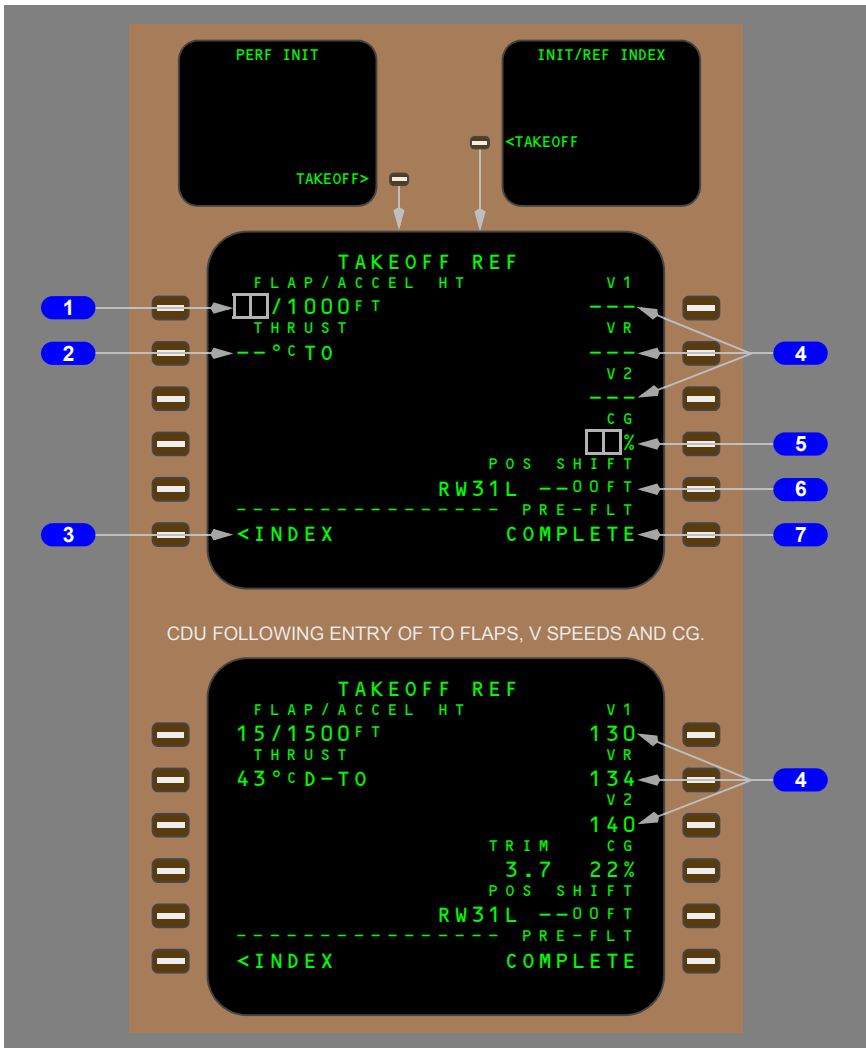

**1 Flap/Acceleration Height (FLAP/ACCEL HT)**

Enter a valid takeoff flap setting.

Entry of a value after takeoff speeds are entered removes the speeds and displays the scratchpad message TAKEOFF SPEEDS DELETED.

ACCEL HT displays the acceleration height in feet above the origin airport. VNAV commands acceleration at this altitude or at first flap retraction.



Default value is from the AMI.

Valid flight crew entries are from 400 to 9999 feet above the origin airport elevation.

## **2 THRUST**

Initially displays dashes and the thrust reference mode.

If an assumed temperature value is entered on the thrust mode select panel (TMSP), the selected temperature is displayed here.

Valid flight crew entries are from 0 to 99 (°C) or 32F to 210F (°F). The entered value is displayed on EICAS.

Entry of a value after takeoff speeds are entered removes the speeds and displays the scratchpad message TAKEOFF SPEEDS DELETED.

## **3 INDEX**

Push – displays the INIT/REF INDEX page.

## **4 V Speeds**

Dashes are displayed before speeds are entered and when speeds have been deleted.

Flight crew entered speeds are displayed in large font. V1 and VR are displayed on the ADI speedtape.

If performance data is changed after speeds are entered, the speeds are deleted, dashes are displayed, and the scratchpad message TAKEOFF SPEEDS DELETED is displayed.

## **5 TRIM, Center of Gravity (CG)**

Valid entry is CG within the valid range.

After the CG is entered, the FMC calculates and displays the stabilizer takeoff trim setting to the left of the CG entry

## **6 Position Shift (POS SHIFT)**

Displays the departure runway from the active RTE page and allows entry of a distance between departure runway threshold and where the autothrottle will be engaged for takeoff.

The FMC updates its position to the departure runway threshold when the autothrottle is engaged for takeoff. If a position shift distance is entered, upon autothrottle engagement the FMC updates its position to that entered distance from the departure runway threshold.

If an intersection takeoff is planned, the intersection identifier or a positive value should be entered. If a displaced threshold takeoff is planned a negative value should be entered.

Valid position shift entries are -99 to +99 in hundreds of feet (9 or 09 is 900 feet beyond the runway threshold).

Entry of a value after takeoff speeds are selected removes the speeds and displays the scratchpad message TAKEOFF SPEEDS DELETED.

POS SHIFT update inhibited when GPS is primary FMC navigation source (i.e. GPS NAV is ON).

## 7 Pre-Flight (PRE-FLT) Status

Displays COMPLETE if all required pre-flight entries have been made.

Displays a prompt to access a pre-flight page where further entries are required if pre-flight is not complete.

## Menu Page

The MENU page allows access to other airplane systems which are controlled with the CDU.

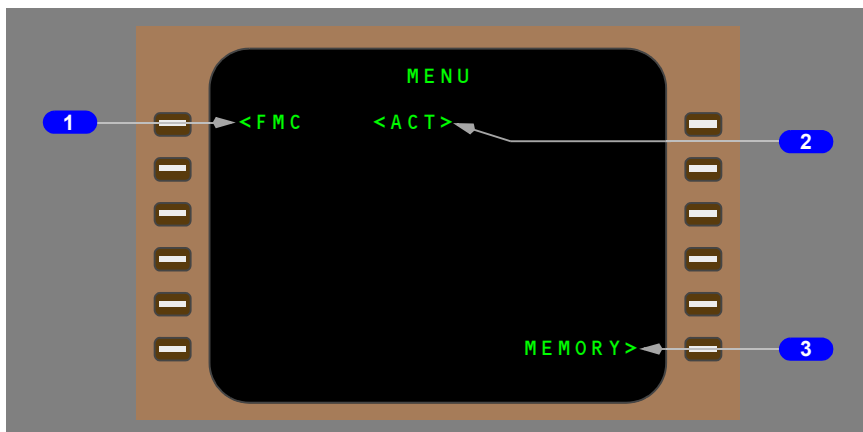

### 1 FMC

Push – connects FMC to CDU

### 2 CDU Status

- <ACT> – indicates system currently controlling CDU
- <REQ> – indicates inactive CDU function requiring pilot action
- blank – indicates function is not selected or requiring action

**3 MEMORY (not displayed while airborne)**

Push – displays maintenance memory page, providing access to computer memory for maintenance while the airplane is on the ground

Intentionally  
Blank

---

## Introduction

The takeoff phase of flight starts with the selection of takeoff thrust at the start of the takeoff roll.

If GPS is not available, the FMC position is updated to the takeoff runway position when the autothrottle is engaged for takeoff.

The takeoff mode of the autoflight system provides flight director guidance until LNAV and VNAV are engaged after takeoff. Preparation for this phase starts in the preflight phase and includes entry of the TAKEOFF REF page data.

The takeoff phase changes to the climb phase when climb thrust and VNAV are engaged. The climb phase continues to the top of climb point, where the cruise phase starts.

---

## Takeoff Phase

When changes are made to the departure runway and SID, the DEPARTURES and TAKEOFF REF pages must be modified to agree. The modified data are entered the same as during preflight.

During takeoff, the autothrottle commands the selected thrust and the autoflight system provides pitch and roll commands through the flight director.

When armed before takeoff, LNAV engages at 50 feet radio altitude. When engaged, FMC roll commands fly the active route leg.

---

## Climb Phase

When climb thrust and VNAV are engaged the FMC provides pitch commands to maintain the climb speed until the acceleration height is reached. At the acceleration height the FMC commands acceleration to 250 knots.

The VNAV commanded speed is limited by the airplane configuration. At acceleration height, VNAV commands a speed 5 knots below the flap placard speed.

Passing 10,000 feet, VNAV commands an acceleration to the economy climb speed, which is maintained until reaching the cruise altitude unless the climb profile contains other constraints.

During the climb, VNAV complies with the LEGS page waypoint altitude and speed constraints. A temporary level-off for a crossing altitude restriction is accomplished at the commanded speed.

When the climb speed profile causes an anticipated violation of a waypoint altitude constraint, the FMC shows the CDU scratchpad message UNABLE NEXT ALT. A different speed profile that gives a steeper climb angle must be manually selected.

A decrease in airspeed may be observed during VNAV level off to cruise altitude if the rate of climb is high at the level off capture point. VNAV will continue a smooth level off and eventually accelerate to the selected cruise speed. During level off under these conditions, VNAV will not allow the airspeed to decrease below the best hold speed for that altitude, which is above the minimum maneuvering speed.

## Climb Page

The climb page is selected by pushing the CDU VNAV function key while on the ground, during takeoff, or in climb.

The climb page is used to evaluate, monitor, and modify the climb path. The data on the climb page comes from preflight entries made on the route and performance pages, and from the FMC data bases.

When the airplane reaches the top of climb, the FMC changes to the cruise mode, the cruise page is displayed and the climb page data is blanked.

The FMC provides speed control in the climb mode to provided the best economy, a fixed speed, or the engine out speed. In each mode, the same type of data is shown on the page.

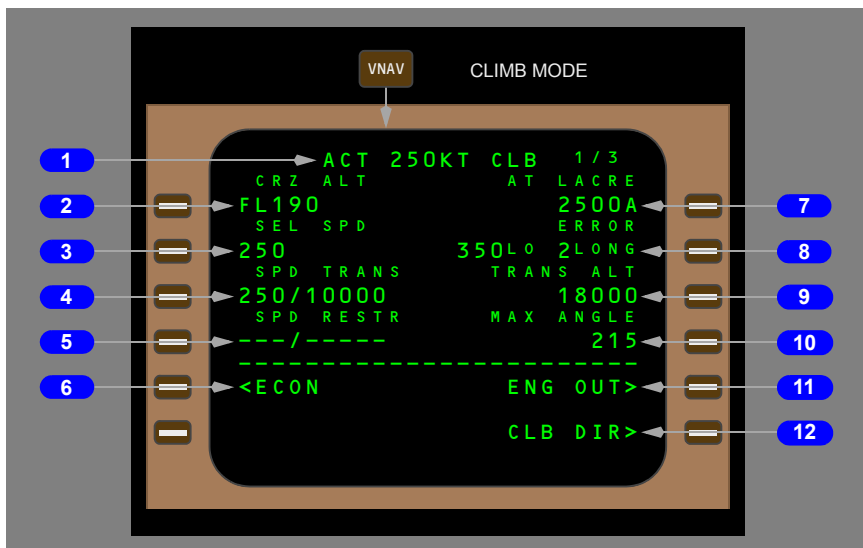

## **1 Page Title**

ACT is displayed when the climb phase is active.

The page title displays the type of climb:

- ECON – speed based on the cost index
- LIM SPD – speed based on airplane configuration limiting speed
- MCP SPD – MCP speed intervention selected
- EO – engine out mode selected
- XXXKT – fixed CAS climb speed profile
- M.XXX – fixed Mach climb speed profile

Fixed climb speeds are for:

- climb segment constraints
- waypoint speed constraints
- an altitude constraint associated with a speed constraint
- a speed transition
- a flight crew selected speed.

## **2 Cruise Altitude (CRZ ALT)**

Displays cruise altitude entered on PERF INIT page.

Valid entries are: XXX, XXXX, XXXXX, or FLXXX. Altitude displays in feet or flight level depending on transition altitude.

## **3 Economy Speed (ECON SPD), Selected Speed (SEL SPD)**

ECON SPD

- economy speed based on cost index
- shows CAS and Mach values.

SEL SPD

- shows when intermediate level off required below an existing speed constraint
- shows when flight crew enters speed
- CAS or Mach value may be entered.

## **4 Speed Transition (SPD TRANS)**

The speed transition line shows the transition speed/altitude from one of these sources:

- the navigation database value for the origin airport
- a default speed of 250 knots and 10,000 feet.

Not displayed above the transition altitude.

Can be deleted.

### **5 Speed Restriction (SPD RESTR)**

Speed restrictions not associated with specific waypoints are manually entered on this line.

Dashes before entry by flight crew.

Valid entry is a CAS and altitude (example 240/8000).

### **6 Economy (ECON)**

Push – changes climb speed to ECON. Must be executed.

Prompt is shown on line 5L when the climb mode is not ECON.

### **7 Waypoint Constraint (AT XXXXX)**

Displays next airspeed and/or altitude constraint at waypoint XXXXX.

FMC commands the slower of constraint speed or performance speed.

Constraints are entered on RTE LEGS page or are inserted as part of a SID.

Delete here or on RTE LEGS page.

Blank if no constraint exists.

### **8 ERROR at Waypoint**

Displays altitude discrepancy and distance past waypoint where altitude will be reached.

Blank if no error exists.

### **9 Transition Altitude (TRANS ALT)**

Transition altitude for origin airport contained in navigation database. FMC uses 18,000 feet if transition altitude is not available.

Manually change transition altitude here or on DESCENT FORECAST page.

Valid entries are XXX, XXXX, XXXXX, or FLXXX.

Altitude information displayed on the CDU changes from altitudes to flight levels above the transition altitude.

### **10 Maximum Angle (MAX ANGLE)**

FMC calculated speed to provide maximum angle climb.

Entry not allowed.

### **11 Engine Out (ENG OUT)**

Push – modifies page to show engine out (ENG OUT) performance data.



## 12 Climb Direct (CLB DIR)

Push – deletes all waypoint altitude constraints between the airplane altitude and the MCP altitude. FMC cruise altitude is not affected.

Blank if no constraints exist.

## Engine Out Climb

Engine out VNAV climb guidance is displayed on the engine out climb page. The engine out climb page must be selected and executed by the flight crew. Engine out data is available with all engines operating. Engine out climb changes to engine out cruise at the top of climb.

## Engine Out Climb Page

The modified page displays engine out performance limitations. Manual entries are allowed. After the modification is executed VNAV gives single engine guidance in the climb.



## 1 Cruise Altitude (CRZ ALT)

Displays cruise altitude if less than MAX ALT.

Displays MAX ALT if less than cruise altitude.

Manual entry is allowed.

**2 Speed Line (EO SPD)**

Displays engine out best gradient climb speed (EO SPD) when page first selected. Any valid speed can be entered.

Valid entry is XXX for CAS.

Valid entry is 0.XXX for Mach. Trailing zeros can be omitted.

A manual entry changes the line heading to SEL SPD and may cause MAX ALT to change.

**3 EO SPD**

Push - resets command speed to best gradient speed and may cause MAX ALT to change. Blank when EO SPD is displayed on the speed line.

**4 Maximum Altitude (MAX ALT)**

Lower of maximum altitude at engine out climb speed or cruise speed.

Entry not allowed.

**5 All Engine (ALL ENG)**

Push – modifies page to display all engine (ALL ENG) performance data.

## Route Legs Page

The RTE LEGS page is used to evaluate and modify the planned route of flight during the climb and to add or delete waypoint constraints to comply with the ATC clearance. The data on the RTE LEGS page comes from preflight entries made on the route and departure pages, and from the FMC data bases.

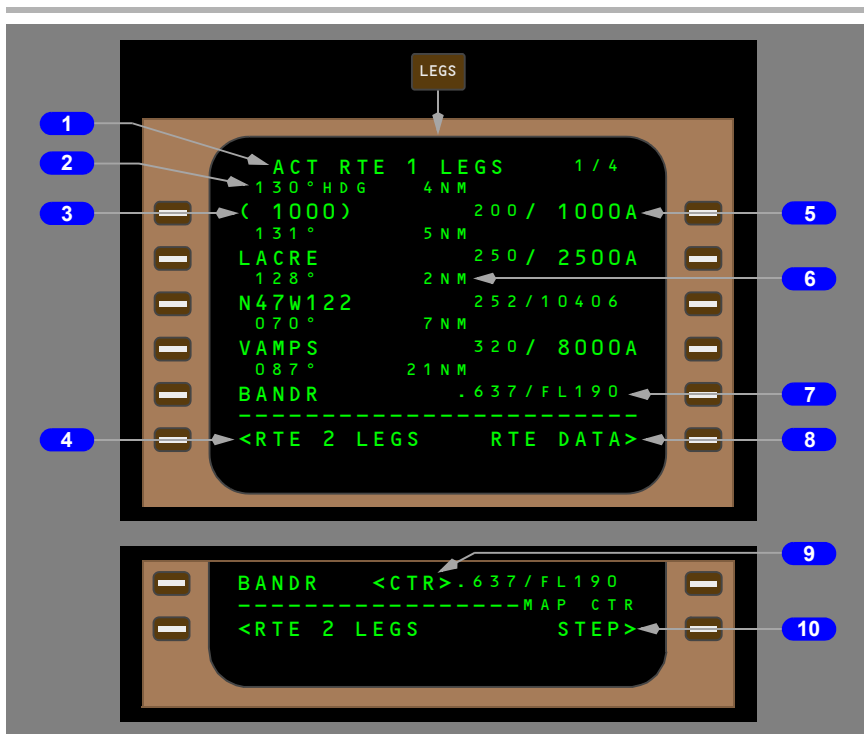

**1 Page Title**

Title format shows route status:

- RTE X LEGS – inactive route
- ACT RTE X LEGS – active route
- MOD RTE X LEGS – modified active route.

**2 Leg Direction**

Leg segment data in line title:

- courses – magnetic (xxx°) or true (xxx° T)
- arcs – distance in miles, ARC, turn direction (example: 24 ARC L)
- heading leg segments – xxx° HDG
- track leg segments – xxx° TRK
- special procedural instructions from database - HOLD AT, PROC TURN.

Calculated great circle route leg directions may be different than chart values.

Dashes are shown for an undefined course.

### **3** Waypoint Identifier

Shows waypoints by name or condition.

Active leg is always the first line of the first active RTE X LEGS page.

All route waypoints are shown in flight sequence. Waypoints on an airway are included on the route legs page.

Waypoints can be modified. Examples:

- add waypoints
- delete waypoints
- change waypoint sequence
- connect route discontinuities.

Boxes are shown for route discontinuities.

Dashes are displayed on the line following the last waypoint on the route.

### **4** Route 2 Legs (RTE 2 LEGS)

Push –

- shows the RTE 2 LEGS
- when RTE 2 LEGS page is shown, prompt changes to RTE 1 LEGS.

### **5** Waypoint Speed/Altitude Constraints

Waypoint speed or altitude constraint in large font.

Manual entry allowed in climb or descent phase. Entered by FMC when constraints are part of a procedure.

Speed constraint is assumed to be at or below the displayed speed.

Valid entries are:

- speed – airspeed or Mach – requires an altitude constraint at the same waypoint
- altitude in thousands of feet or flight level (19000, 190)
- XXX/XXXXX – airspeed/altitude entered simultaneously
- XXX/ – airspeed only
- XXXXX or /XXXXX – altitude only.

Altitude constraint suffixes:

- blank – cross at altitude
- A – cross at or above altitude
- B – cross at or below altitude
- both – altitude block. Example: 220A240B

**6 Distance to Waypoint**

Distance between the waypoints displayed in nautical miles.

The first line displays the distance from the airplane to the active waypoint.

**7 Waypoint Speed/Altitude Predictions**

Waypoint speed and altitude predictions are displayed in small font.

Dashes are displayed in the descent region prior to descent path calculation.

Descent path calculation requires altitude constraint below cruise altitude.

**8 ACTIVATE, Route Data (RTE DATA)**

Push – three possible prompts

- ACTIVATE – activates inactive flight plan; shows RTE DATA prompt
- RTE DATA – shows route data page
- STEP – changes the center point on the HSI map in the PLAN mode.

**9 Center (<CTR>)**

Displays when PLAN mode selected.

Displays adjacent to the waypoint around which HSI plan mode is centered.

**10 MAP Center (CTR) STEP**

Replaces ACTIVATE or RTE DATA when PLAN mode selected.

Push – steps <CTR> to next waypoint. HSI plan mode recenters.

## Engine Out Departure



### 1 Engine Out Standard Instrument Departure (EO SID)

Engine out SIDs can be created by the airline for specific runways. If there is an EO SID in the database for the departure runway it will be listed on the departures page after the runway is selected.

The FMC puts the EO SID into the route as a modification if:

- an engine failure is sensed
- flaps are extended
- and the navigation database has an EO SID for the departure runway.

The modification can be executed or erased.

## Air Turn-Back

### Arrivals Page

During a turn-back situation, the flight crew requires quick access to the arrivals data for the origin airport. The arrivals page allows access without changing the destination on the route page.

During climb if the airplane is less than 400 miles from the origin and less than half way to the destination, push the DEP ARR key to show the ARRIVALS page for the origin airport.

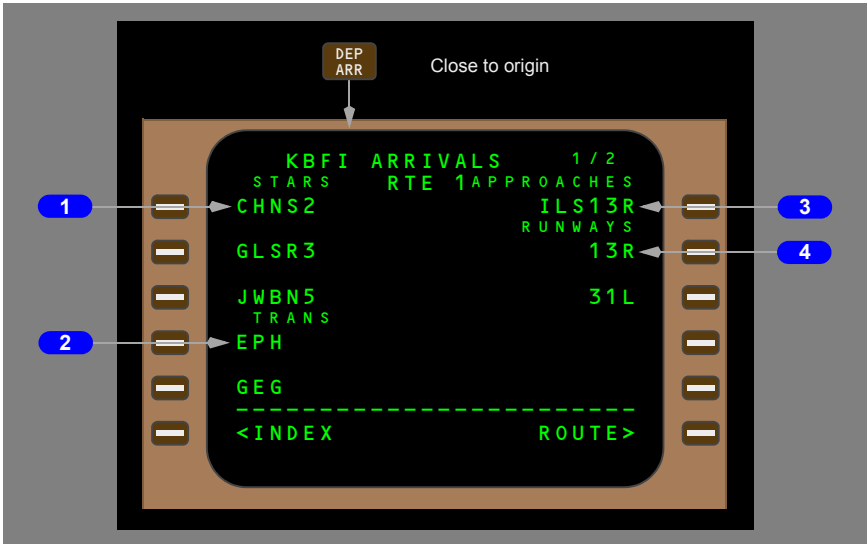

### 1 Standard Terminal Arrivals (STARS)

Shows STARS for origin airport.

### 2 Transitions (TRANS)

Shows transitions for origin airport.

### 3 APPROACHES

Shows approaches for origin airport.

### 4 RUNWAYS

Shows runways for origin airport.

The arrivals page is discussed in more detail in the Descent and Approach Section (11.43) of this chapter.

Intentionally  
Blank



---

**Introduction**

The cruise phase starts at the top of climb.

During cruise, the primary FMC pages are:

- RTE X LEGS
- CRZ
- PROGRESS.

The RTE LEGS pages are used to modify the route. The CRZ pages display VNAV related data. The PROGRESS pages display flight progress data. During cruise, the specific page listed below is used to:

- POS REF page – verify the FMC position
- RTE DATA page – display progress data for each waypoint on the RTE LEGS page
- WINDS page – enter forecast wind and temperature
- REF NAV DATA page – display data about waypoints, nav aids, airports, or runways, and can be used to inhibit nav aids
- RTE page – select a route offset
- FIX INFO page – display position data about waypoints. Position data can be transferred to other pages to create new waypoints and fixes
- SELECT DESIRED WAYPOINT page – shows a list of duplicate waypoints from the navigation database. The flight crew selects the correct waypoint from the list
- POS REPORT page – display data for a position report.

The CLB page changes to CRZ at the top of climb. The CRZ CLB and CRZ DES pages change to CRZ when a new cruise altitude is reached. The CRZ page changes to DES at top of descent.

---

**LNAV Modifications**

This section shows typical techniques to modify the route. The modifications include:

- add and delete waypoints
- connect discontinuities
- change waypoint's sequence
- intercept a course.

**RTE LEGS Page Modifications**

Modifications to the LNAV route are usually made on the RTE LEGS page. When the route is modified, MOD is displayed in the title and the execute light is illuminated.

## Add Waypoints

Waypoints can be added to the route at any point. Added waypoints are followed by route discontinuities.

First, enter the waypoint name in the scratchpad.

Second, locate the correct line in the flight plan and push the adjacent line select key. The scratchpad waypoint name is put into the selected line. The entered waypoint is connected to the waypoint above it via a direct route. A route discontinuity follows the waypoint.

For example, OED is typed into the scratchpad. Push line select key 2L to put OED into line 2. The FMC assumes BTG direct OED. RBL and the rest of the flight plan are kept but, are put after the route discontinuity.

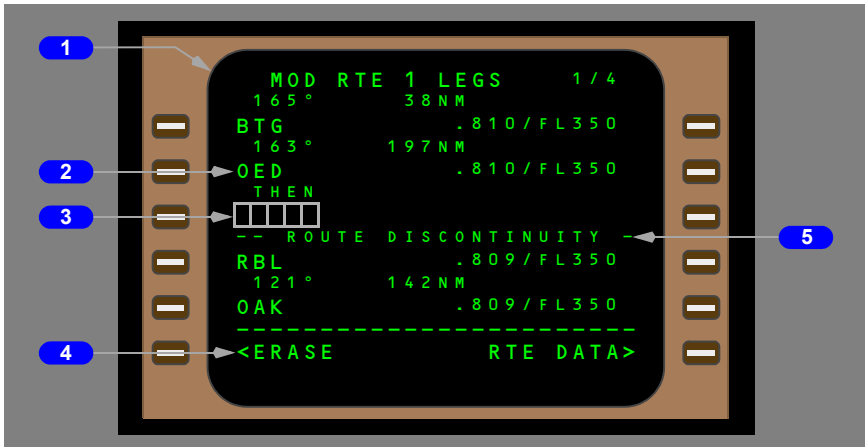

### 1 Page Title

MOD – replaces ACT when modification is in progress.

ACT – replaces MOD when ERASE is selected or execute key is pushed.

### 2 Modified Waypoint

OED waypoint entered into the route after BTG. Modification creates a route discontinuity because OED was not in the active route. The FMC now requires routing beyond OED.

### 3 Discontinuity

Discontinuity is corrected when applicable waypoint is entered in boxes.

---

**4 ERASE**

Push – removes all modifications and shows active data.

Displayed when the FMC contains modified data.

Removed when the modifications are executed.

**5 ROUTE DISCONTINUITY**

Line title separates route segments when there is a discontinuity.

**Note:** Performance predictions to destination on the PROGRESS page are calculated assuming the route of flight is direct between waypoints on either side of a route discontinuity.

### **Delete Waypoints**

Use the RTE LEGS page to remove waypoints from the route. The active waypoint can not be deleted. Two methods to remove a waypoint are:

- delete the waypoint with the DEL function key
- change the sequence of other waypoints.

The data in the route before the deleted waypoint does not change. A discontinuity is put in the route when the DEL function key is used to remove a waypoint.

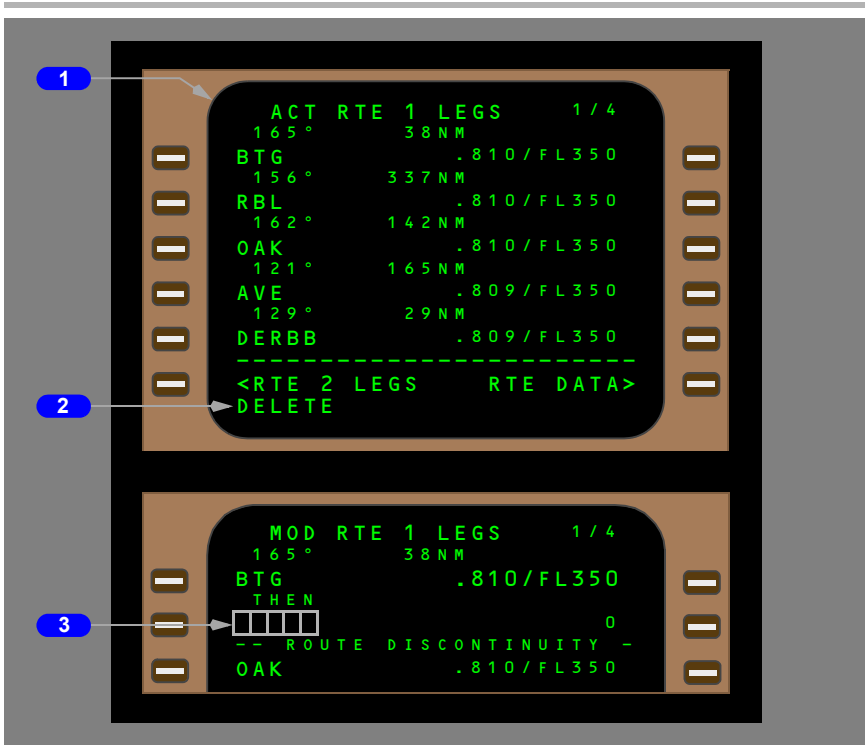

**1 Active Route**

The active route shows RBL followed by OAK and AVE.

**2 DELETE Entry**

Pushing the DEL function key arms the delete function and selects DELETE to the scratchpad.

**3 Discontinuity**

With DELETE in the scratchpad, pushing the line select key for RBL deletes the waypoint. Boxes replace RBL and a route discontinuity is displayed.

### Change Waypoint Sequence

Waypoints moved from one position in the flight plan to another do not cause route discontinuities.

The waypoint may be manually typed or copied from any of the RTE LEGS pages. To copy the waypoint, push the line select key adjacent to the waypoint.

**757 Flight Crew Operations Manual**

The example below shows the flight plan being modified to fly from BTG direct OAK. Push the line select key adjacent to OAK to put OAK in the scratchpad. Push the line select key adjacent to RBL. RBL is removed from the flight plan and the routing is direct from BTG to OAK to AVE. The modification does not cause a route discontinuity. Several waypoints can be removed from the flight plan at a time with this method.

**1 Active Route**

The active route shows RBL followed by OAK and AVE. The clearance is to fly from BTG direct OAK. The OAK waypoint is selected to the scratchpad.

**2 Change OAK's Sequence**

OAK is selected to the waypoint after BTG. RBL is removed with no discontinuity.

**Remove Discontinuities**

A discontinuity exists when two waypoints are not connected by a route segment. To remove a discontinuity, copy the subsequent waypoint from the route into the scratchpad and enter it into the discontinuity.



### 1 Discontinuity

The active route has a discontinuity after BTG. The example shows how to fly direct from BTG to OAK. Copy OAK to the scratchpad. Any subsequent waypoint in the route can be selected to the scratchpad to remove the discontinuity.

### 2 Continuous Route

Select OAK to the boxes to remove the discontinuity.

If a waypoint which does not already exist on the route is entered into the boxes the discontinuity moves one waypoint further down the route.

## Direct To And Intercept Course To

If the airplane is not on the active leg segment, LNAV may deactivate or it may not activate when armed. This happens after the airplane crosses a discontinuity, or is not on an intercept heading to the active leg segment. Here are three ways to arm or activate LNAV:

- When the airplane is within 2.5 miles of the active leg, push the LNAV switch. LNAV activates and intercepts the active route leg.
- When more than 2.5 miles from the active leg, push the LNAV switch when the airplane is on an intercept heading to the active route leg. Initially, LNAV arms and then activates as the airplane approaches the active leg. An intercept heading must intersect the active leg inbound before the active waypoint.
- Fly direct to a waypoint or intercept a course to a waypoint. Enter a waypoint in the RTE LEGS page active waypoint line to fly direct. Use the INTC CRS TO prompt in line 6R to create an intercept course to the waypoint. Push the LNAV switch and LNAV arms or activates, depending on the distance from the active leg.

### Modification of the Active Waypoint

The example below depicts the airplane being off course to the right, followed by a modification to fly direct to BTG.

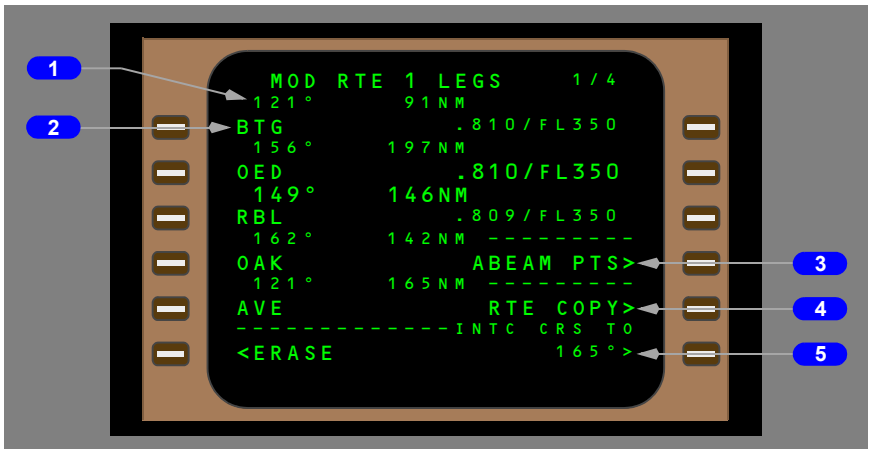

#### 1 Course to Active Waypoint

Prior to execution, displays direct-to inbound course at waypoint; changed by entry in INTC CRS line or by selecting intercept course.

After execution, displays current required track to fly inbound course to waypoint.

## **2 Active Waypoint**

Displays crew entered direct/intercept waypoint. If entered waypoint is not part of the active route it will be followed by a discontinuity.

## **3 ABEAM Points (PTS)**

Push -

- creates abeam points on new route to indicate waypoints bypassed by direct to function
- abeam points are perpendicular to the waypoints bypassed
- line title displays ABEAM PTS, line data displays SELECTED
- subsequent route modifications remove ABEAM PTS prompt.

## **4 Route (RTE) COPY**

Push -

- copies active unmodified route into inactive route
- erases previous inactive route
- line title displays RTE COPY, line data displays COMPLETE
- subsequent route modifications remove RTE COPY prompt.

## **5 Intercept Course To (INTC CRS TO)**

Displays boxes if entered waypoint not in the active route.

Displays current route course and prompt caret if entered waypoint in the active route. Allows entry of a different inbound course via the scratchpad.

When boxes displayed, valid entry is intercept course from 000 to 360.

Push -

- when course displayed, selects current route course as intercept course to active waypoint
- when course is displayed and a different course has been entered in the scratchpad, the scratchpad value is entered as the intercept course to the active waypoint
- selection or entry displays as course to active waypoint
- selection or entry removes ABEAM PTS and RTE COPY prompts.

## **Intercept Course From**

The steps to create an intercept course from a waypoint are nearly the same as the steps for an intercept course to. The waypoint name in the scratchpad is suffixed with the outbound course.



An intercept course can be created outbound from a waypoint in the navigation data base or from present position. The waypoint does not have to be in the route. Entering a waypoint and course pair in the active waypoint line displays the INTC CRS FROM prompt. The FMC calculates a route leg with the waypoint as the origin of the entered course.

The example shows a 160° course from BTG, entered as BTG160. When this course intercept is line selected to the active waypoint line, the waypoint displays as a conditional waypoint consisting of a course intercept (160°).

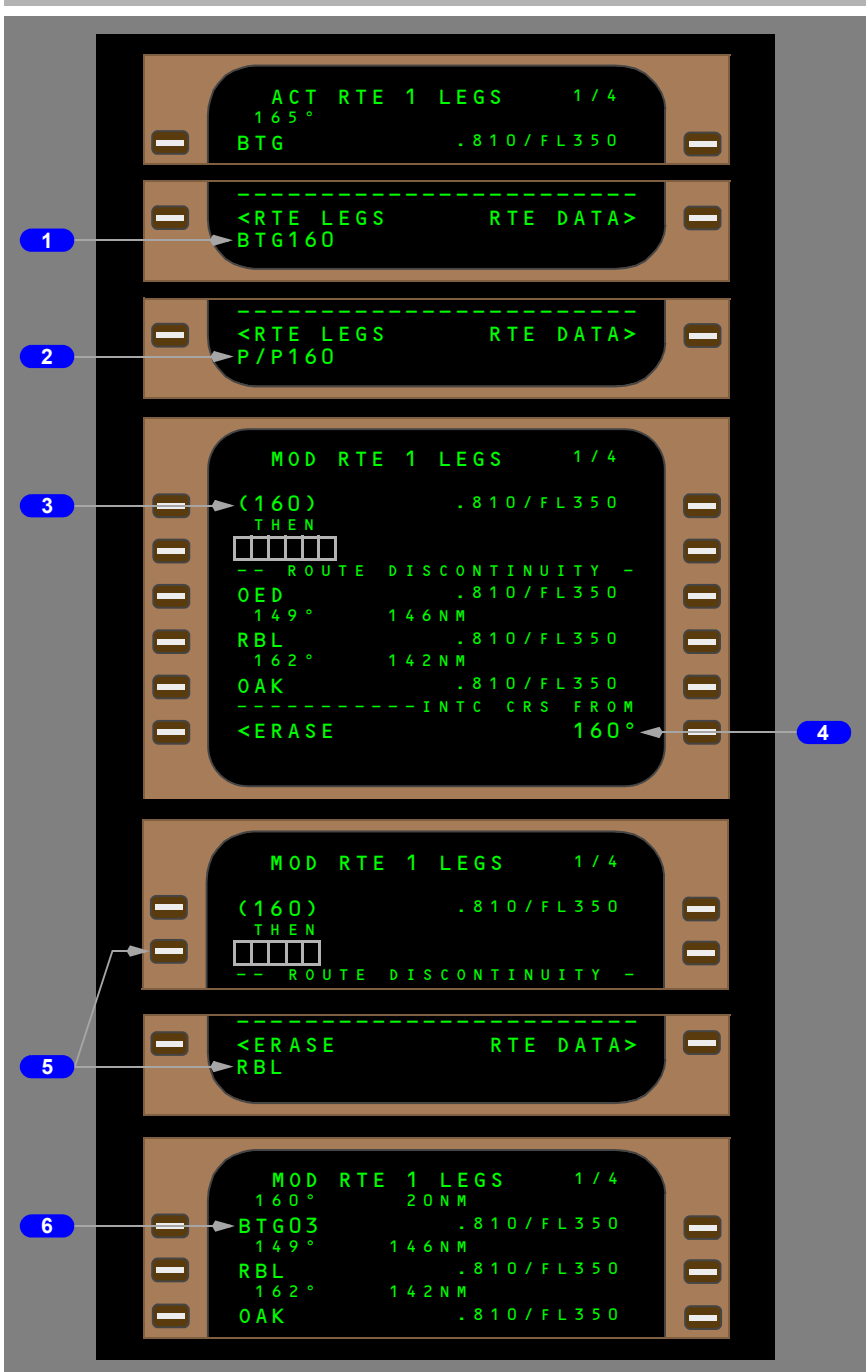

**1 Waypoint and Outbound Course**

Enter the waypoint name and outbound course in the scratchpad.

**2 Present Position and Outbound Course**

Enter P/P and outbound course in the scratchpad.

**3 Active Outbound Course Entry**

After the active waypoint line is selected, the outbound course is displayed. The waypoint name is not used.

For example, BTG160 is entered into the active waypoint line. The FMC calculates a new route leg with BTG as the origin on a outbound course of 160°.

**4 Intercept Course From (INTC CRS FROM)**

Displays outbound course from entered waypoint.

Shows the active waypoint name is modified with P/P or waypoint outbound entry.

Valid input is any course from 000° through 360°. May be changed until executed.

**5 Next Waypoint**

Enter a down track waypoint into the boxes. To resolve the discontinuity the waypoint must be part of the active route and the inbound course to that waypoint must be intersected by the entered course.

**6 Created Waypoint**

If the 160° course intercepts the course inbound to the entered waypoint, a new waypoint is created at the intercept point. Line selecting the new waypoint results in a place, bearing, distance format in the scratchpad.

**SELECT DESIRED Waypoint (WPT) Page**

The SELECT DESIRED WPT page is displayed when a waypoint identifier or name is entered and the navigation database contains more than one location for the same waypoint name. Selection of a waypoint returns the display to the previous page.



### 1 Identifier

Displays a list of the waypoints in the navigation database that have the same identifier as entered.

Up to 48 waypoints (8 pages) can be listed.

Waypoints are sorted as follows:

- when page is accessed as a result of a flight plan entry or modification, sort is based on proximity to the waypoint preceding the entered waypoint
- when page is accessed as a result of a DIR/INTC, FIX INFO, or REF NAV DATA entry, sort is based on proximity to current aircraft position.

Select the desired waypoint by pushing either the left or right line select key adjacent to the waypoint. The CDU page where the waypoint identifier was entered is then displayed with the selected waypoint inserted.

### 2 Frequency

Displays frequency of the waypoint if it is a navaid. Blank if the waypoint is not a navaid.

### 3 Type

Displays the type of waypoint for each duplicate name.

### 4 Latitude/Longitude

Displays the latitude/longitude for each duplicate name.

## Airway Intercept

Just as in intercept to/from, LNAV can be used to intercept an airway. An airway intercept changes the active waypoint on the RTE and LEGS pages.

Enter the airway identifier under VIA on line 1 of the RTE page. Boxes display under TO. Enter the desired airway exit waypoint in the boxes. For this open-ended airway intercept, the FMC selects the waypoint preceding the closest abeam location as the starting waypoint of the airway. This waypoint displays on line 1. The entered airway and the desired exit point display on line 2. Executing the modification makes the leg to the FMC selected airway start waypoint the active leg segment.

If the clearance heading intercepts the active leg segment, LNAV can be armed and the intercept will occur. In most airway intercept situations, the commanded heading will not intercept the active leg.

If the clearance heading does not intercept the active leg segment, use the intercept–course–to procedure to make the course inbound to the waypoint after the crossing location the active leg segment.

### Example

The active route is direct to EPH, then direct to MWH. ATC clears the airplane to:

- turn right heading 110°
- intercept V2 to MWH.

Following the V2 modification to MWH and execution, the LEGS page displays this waypoint sequence:

- BANDR
- BEEZR
- ELN
- PLUSS
- MWH.

Modify the LEGS page using a course intercept to the waypoint after the crossing location. In this case, it would be PLUSS. PLUSS becomes the active waypoint on the V2 airway. The LEGS page now displays:

- PLUSS
- MWH



**1 Active RTE 1 Page**

The route page before the ATC clearance.

**2 Input Airway**

Enter the airway in the first VIA position on the RTE page. Boxes display in the TO position. A route discontinuity follows on the next line.

**3 Airway Exit**

Enter desired airway exit point in the boxes.



#### 4 Start Airway Waypoint

After entering MWH in the boxes:

- the FMC selects BANDR as the airway start waypoint
- the airway line moves down one line
- dashes are shown in the VIA to the start airway waypoint.

#### 5 New Active Waypoint

Following modification and execution of the course intercept procedure to PLUSS, the LEGS page displays PLUSS as the active waypoint. LNAV can be armed and the airway intercept can be completed.

### Route Offset

Route offsets are selected on the RTE page. The OFFSET prompt displays on the RTE page when the airplane is not on a SID, STAR, or transition. Entering a distance value into the OFFSET dashes creates the selected offset. An offset propagates along the route from the active waypoint until a discontinuity, approach, approach transition, holding pattern, course change of greater than 135°, or end of route is reached. An offset can be removed by deleting the offset waypoints, proceeding direct, or entering an offset value of zero.

The offset is shown as a white dashed line on the HSI until the offset modification is executed or erased.

After execution, the offset route is shown as a dashed magenta line on the HSI. The original route remains a solid magenta line.

If LNAV is engaged when the offset is executed, the airplane turns to an intercept heading to capture the offset course.



## **1** OFFSET

Enter the necessary offset. When executed, the CDU OFST light illuminates.

Valid entries are L (left) or R (right) followed by a distance from 0 to 99 in nautical miles.

## Cruise Page

### All Engine Cruise

The cruise page is used to monitor and change cruise altitude and speed. Speed changes can be manually selected or automatically selected with the selection of other VNAV modes. Cruise climbs, cruise descents, and step climbs can be accomplished from the cruise page.

When using the economy mode, page data is based on operating at ECON SPD. Economy cruise speed is based on cost index. When the flight crew enters a selected speed, page data changes. When the FMC is in the engine out mode, the data changes to include the airplane capabilities with one engine inoperative. The long range cruise (LRC) mode calculates speeds to maximize airplane range.



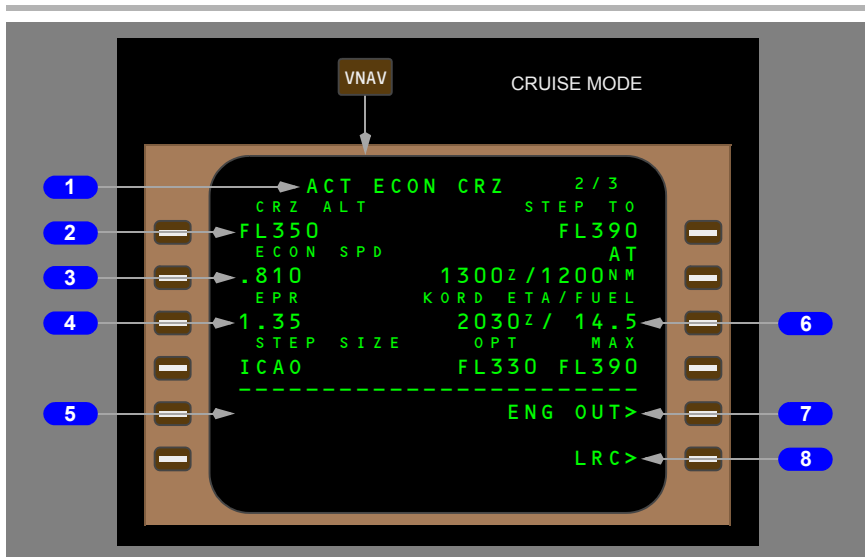

### 1 Page Title

The page title displays active (ACT) or modified (MOD) cruise. Usually, the title contains ECON for economy cruise. Fixed speed, engine out, and long range cruise modify the title.

Page titles include:

- CO – engine out mode and Company specified speed selected
- CRZ CLB or CRZ DES – cruise climb or descent
- ECON – speed based on cost index
- EO – engine out mode selected
- EO D/D – engine out drift down displayed when EO selected and the airplane altitude is above the maximum altitude for engine out performance
- LIM SPD – based on an airplane configuration limiting speed
- LRC – long range cruise selected
- MCP SPD – speed intervention applied from the MCP
- M.XXX – fixed Mach cruise speed
- XXXKT – fixed CAS cruise speed.

Fixed cruise speeds are for:

- waypoint speed constraints
- an altitude constraint associated with a speed constraint
- a flight crew selected speed (SEL SPD).

## **2 Cruise Altitude (CRZ ALT)**

Displays cruise altitude entered on PERF INIT page.

Valid entries are: XXX, XXXX, XXXXX, OR FLXXX. Altitude displays in feet or flight level depending on the transition altitude. Changing the MCP altitude enters the new altitude in the scratchpad for entry. Entry creates a modification.

When the modification is executed the page title changes to CRZ CLB or CRZ DES.

## **3 Economy Speed (ECON SPD), Selected Speed (SEL SPD)**

Displays target speed or Mach.

MOD displays in the page title until the modification is erased or executed.

A manually entered speed changes the line title to SEL SPD.

ECON can be replaced with LRC or company (CO SPD), depending on the VNAV mode.

## **4 EPR**

Displays EPR necessary for level flight at the target airspeed.

## **5 Economy (ECON)**

Blank when ECON is the active speed. Displays a prompt when ECON is not the active speed.

Push – selects economy cruise speed.

## **6 Destination ETA/FUEL**

Estimated time of arrival and calculated fuel remaining at the destination.

Displays the same data for the alternate airport when a DIVERT NOW modification is selected from the ALTN page.

Calculations are based on optimum step climbs and cruise altitudes.

## **7 Engine Out (ENG OUT)**

Push –

- displays engine out cruise page
- commands engine out performance calculations
- changes CRZ ALT if above maximum engine out altitude
- changes target speed to engine out LRC speed
- upon execution, thrust reference mode changes to CON.

## 8 Long Range Cruise (LRC)

Push –

- displays long range cruise page
- changes target speed to LRC speed.

## Engine Out Cruise

Engine out VNAV cruise guidance is displayed on the engine out cruise page. Engine out data is also available with both engines operating.

The initial page data includes engine out performance limitations. Manual entries are allowed. When above the maximum engine out cruise altitude, VNAV calculates engine out guidance for drift down (D/D). The engine out drift down page changes to the engine out cruise page when reaching the engine out cruise altitude. Subsequent engine out cruise climb or descent is accomplished the same as two engine cruise climb or descent.

As the airplane gross weight decreases, maximum altitude increases. A step climb may be possible under these conditions.

The example is based on a cruise altitude above the maximum engine out altitude.



### 1 Page Title

Displays ACT EO D/D (for this example, airplane is above MAX altitude).

---

Displays ACT MCP SPD D/D when controlling to speed entered on the MCP during the driftdown.

Displays ACT LRC (long range cruise) D/D when LRC selected during driftdown.

Displays ACT M.XXX or XXXKT D/D when a selected speed is entered on the speed line.

Displays ACT EO LRC when in level cruise flight and the LRC speed is selected.

Displays ACT EO CRZ CLB or ACT EO CRZ DES during engine out cruise climbs or descents and the airplane is below the engine out maximum altitude.

## **2 Cruise Altitude (CRZ ALT)**

Displays altitude from MAX ALT line when current CRZ ALT above MAX ALT.

Manual entry of an altitude above maximum engine out altitude results in the scratchpad message, "MAX ALT FLXXX".

Valid entries are the same as all engine cruise page.

## **3 Selected Speed (SEL SPD)**

Displays the target speed or Mach. The default display when the page is first selected is engine out speed (EO SPD).

A manually entered speed changes the line title to SEL SPD. Valid entries are the same as all engine cruise page.

SEL SPD can be replaced with long range cruise (LRC), company (CO SPD), or engine out (EO SPD) speed using prompts at the bottom of the page.

Manual entries may change MAX altitude.

## **4 Company Speed (CO SPD)**

Push – Modifies the page with company speed, engine out data from the Airline Policy page.

## **5 Engine Out (EO SPD)**

Push – enables execution of engine out minimum drag speed profile.

Prompt is not displayed when the EO SPD is active.

## **6 Optimum Altitude and Maximum Altitude (OPT MAX)**

OPT – displays the most economical altitude based on airplane gross weight.

MAX – displays the maximum cruise altitude based on:

- engine out operation
- selected speed option
- without any altitude or speed constraints, and
- capable of a 100 feet per minute climb rate.

### 7 ALL Engine (ENG)

Push – displays a MOD XXX CRZ page with performance based on both engines operating.

Selection and execution allows subsequent selection of two engine economy VNAV modes.

### 8 Long Range Cruise (LRC)

Push – enables execution of engine out long range cruise.

Displayed when EO or SEL SPD is the active mode.

## VNAV Modifications

During the cruise phase, VNAV can calculate two types of climbs: cruise climbs and step climbs. Cruise climbs can be entered by the flight crew. Optimum step climbs are calculated by the FMC. In all cases, the new climb altitude must be selected in the MCP altitude window before VNAV commands the climb.

### Cruise Climb

To initiate a cruise climb set the higher altitude on the MCP, then enter the altitude in the CRZ ALT line and execute. When the CRZ page is displayed, the new MCP altitude is automatically copied to the scratchpad to be line selected to the CRZ ALT line.

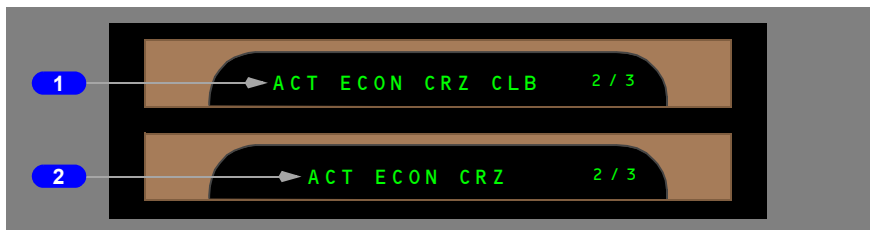

### 1 During Cruise Climb

VNAV page title displays ACT ECON CRZ CLB in a climb to a new cruise altitude. ECON is replaced by the selected speed if other than ECON.

## 2 End of Cruise Climb

VNAV page title returns to ECON CRZ after level off at cruise altitude.

### Planned Step Climb

When a step climb is planned to start at a waypoint, the data can be entered on the RTE LEGS page. The FMC performance predictions assume the airplane will start the climb at the identified waypoint.

The FMC displays the distance and ETA to the step point on the CRZ and PROGRESS page. The corresponding altitude profile point and identifier is shown on the HSI.

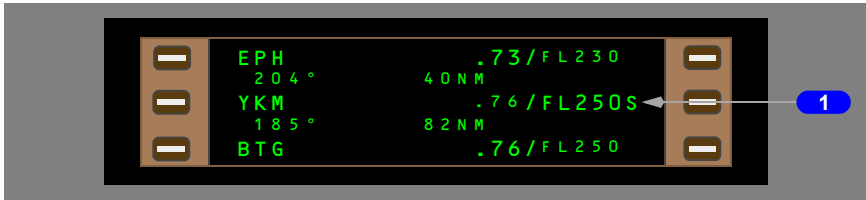

## 1 Step Climb Altitude

Enter the new cruise altitude as an altitude constraint and the letter S. The FMC assumes the step climb starts at the waypoint. Accomplish the step climb at the waypoint with the steps described in cruise climb.

### Calculated Step Climb

When a non-zero value is entered into the STEP SIZE line on the PERF INIT or CRZ page, the FMC calculates optimum points for step climbs as the airplane performance permits. The climb altitude is determined by the value in STEP SIZE. Multiple step climbs are possible based on performance and route length. VNAV commands the step climbs if the MCP altitude and the FMC CRZ ALT are set to the new altitude.

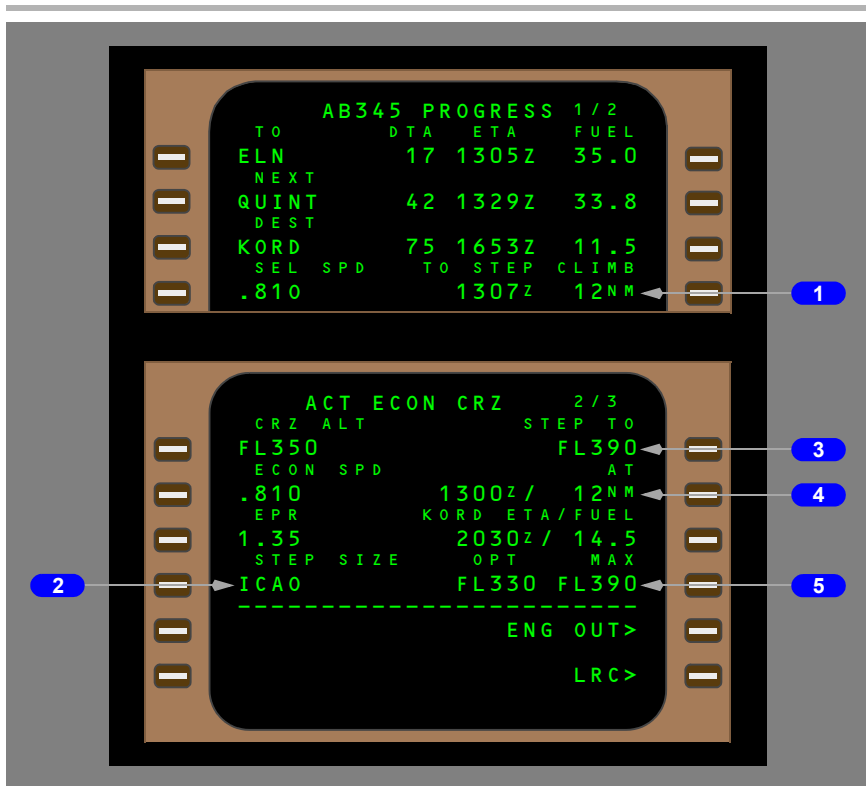

### 1 TO STEP CLIMB

When the step climb start point is the next VNAV event, the line title changes to TO STEP CLIMB.

Displays the ETA and DTG to the point where the step climb starts.

If the airplane passes the step climb point and has not started to climb, the ETA and DTG are replaced with the word NOW.

When the FMC calculates that a step climb is not advised, the ETA and DTG are replaced with the word NONE.

### 2 STEP SIZE

Displays the default step climb size of ICAO.

Valid entries are altitudes from 0 to 9000 in 1000 foot increments.

Used for calculation of optimum step point and step climb predictions.

Deletion of a manual entry defaults back to ICAO.

### 3 STEP TO

An altitude can be entered for a step climb evaluation. The FMC calculates the predicted step climb data and displays the results on this page and the PROGRESS page.

Entering a zero value for STEP SIZE causes the FMC to calculate performance based on a constant altitude flight at the CRZ ALT. Entering a valid, non-zero increment or ICAO step size causes the FMC to calculate performance based on accomplishing step climbs at calculated step climb points.

Step climb altitudes entered on the RTE LEGS page can be higher or lower than the CRZ ALT. These step climb altitudes cannot be overwritten on the CRZ page.

When using the ICAO step size, the STEP TO altitude is the next higher altitude above the OPT altitude corresponding to the direction of flight, based on the CRZ ALT entered before takeoff. Changes to CRZ ALT while in flight do not affect calculation of STEP TO altitudes using ICAO step sizes. However, if an alternate route (for example, Route 2) is activated in flight, the hemispheric altitude will be calculated using the current CRZ ALT.

When using an altitude increment step size, the STEP TO altitude is the next higher altitude above OPT calculated by adding the STEP SIZE increment to the FMC CRZ ALT.

When entering a cruise altitude above maximum altitude, the scratchpad message MAX ALT FLXXX is displayed.

Displays:

- the STEP TO altitude from the RTE LEGS page
- a calculated step climb altitude based on the step size.

Manual entry is allowed.

Blank when:

- there is no active flight plan
- less than 200 NM from the T/D point
- less than 500NM from the destination
- step size is zero
- in the EO D/D phase.

### 4 AT

Displays the ETA and DTG to the step climb point.

Displays NOW when past the calculated step climb point.

Line title changes to AVAIL AT when the climb is restricted by thrust or buffet.

Line title displays AT XXXXX where XXXXX is the waypoint where a planned step climb has been entered on the RTE LEGS page.



Line title changes to TO T/D when within 200 NM of the top of descent point. ETA and DTG are relative to the T/D point.

The data is the same as displayed on the PROGRESS page.

### 5 Optimum Altitude and Maximum Altitude (OPT MAX)

OPT – displays the most economical altitude to fly based on gross weight and the active cruise speed.

MAX – displays the two engine maximum altitude based on gross weight, climb and cruise speeds within the speed envelope, and sufficient excess thrust to provide a specified residual rate of climb capability.

## Cruise Descent

Cruise descents can be started in the cruise phase when the airplane is more than 50 miles from the T/D point.

A cruise descent can be started by selecting a lower altitude on the MCP, entering the new altitude in the CRZ ALT line and executing. A VNAV cruise descent is commanded at the current cruise speed and approximately 1250 feet per minute rate of descent.

The autothrottles adjust thrust to maintain the target descent rate; pitch maintains the commanded speed. Thrust levers can be manually positioned to adjust the descent rate.

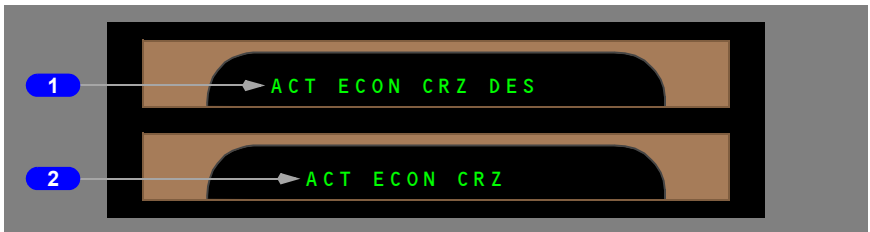

### 1 During Cruise Descent

VNAV page title shows cruise phase in a descent to a new cruise altitude.

### 2 End of Cruise Descent

VNAV page title shows cruise phase after level off at new cruise altitude.

## Early Descent

An early descent starts when the descent for landing is commenced prior to the FMC calculated top of descent (T/D) point. Early descents should not be started when the distance to the T/D is greater than 50 nautical miles. When further from the top of descent point, the cruise descent function should be used.

Early descents are started on the DES page. Once an early descent is started, VNAV changes to the descent phase and cruise features are no longer available.

The autothrottle adjusts thrust to maintain the target descent rate; pitch maintains the commanded speed. Thrust levers can be manually positioned to adjust the descent rate.

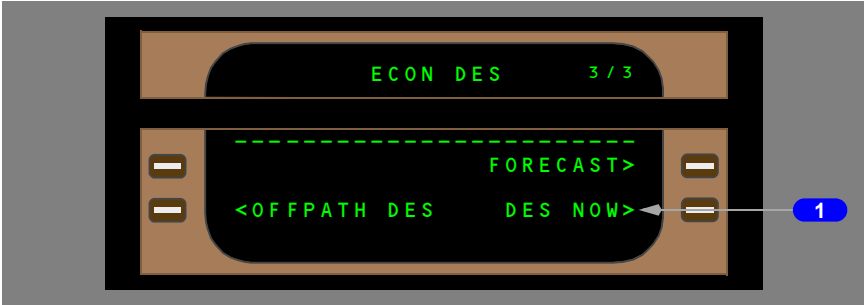

### **1 Descend Now (DES NOW)**

The DES NOW prompt is shown on the descent page when the cruise phase is active. Reset the MCP altitude and select the DES NOW prompt and execute to start an early descent. The descent page becomes active and the airplane starts a VNAV ECON descent of approximately 1250 feet per minute at ECON descent speed.

Once the descent is established the autothrottle mode changes to THR HLD to allow the pilot to adjust the rate of descent with power changes.

Upon reaching the planned descent path, VNAV commands pitch to maintain the planned descent path and ECON speed.

## **Navigation Data**

### **Reference Navigation Data Page**

The reference navigation data page displays data about waypoints, nav aids, airports, and runways. Use this page to inhibit FMC position updates from radio nav aids.



### 1 Identifier (IDENT)

Valid entries are any waypoint, navaid, airport, or runway from the navigation database. Only runways at the destination airport can be entered.

Entry changes to dashes when page is exited and then reselected.

### 2 LATITUDE

Displays latitude of entered identifier. When the identifier is a runway the latitude displayed is for the threshold of the runway.

### 3 Magnetic Variation (MAG VAR), LENGTH

MAG VAR – displays magnetic variation when entered identifier is a navaid.

LENGTH – displays runway length when entered identifier is a runway.

### 4 NAVAID INHIBIT

When a navigation radio is known to provide erroneous position information, the FMC must be inhibited from automatically tuning that navaid.

Enter the identifier of up to two VOR, VOR/DME, VORTAC, or DME stations that must not be used for FMC position updates.

---

Entries are blanked at flight completion. Deleting or overwriting removes a previous inhibit.

### **5 VOR ONLY INHIBIT**

Use this line when only the VOR portion of a VOR/DME or VORTAC navaid must be inhibited. ALL is displayed if VOR/DME NAV prompt is selected to OFF.

Enter the identifier of up to two VORs that should not be used for FMC position updates. Only the VOR portion of the navaid is inhibited, the FMC will still tune the DME for DME–DME updating.

Entries are blanked at flight completion. Deleting or overwriting removes a previous inhibit.

### **6 INDEX**

Push – displays the INIT/REF INDEX page.

### **7 Frequency (FREQ)**

Displays frequency of entered identifier when it is a navaid.

### **8 LONGITUDE**

Displays longitude of entered identifier. When the identifier is a runway the longitude displayed is for the threshold of the runway.

### **9 ELEVATION**

Displays elevation of entered identifier when it is a navaid, airport, or runway.

### **10 VOR/DME NAV**

Alternately switches VOR/DME NAV updating between OFF and ON.

Push – when ON is displayed in large font:

- changes OFF to large font and ON to small font
- inhibits VOR/DME updates to the FMC by inhibiting all VORs. DME-DME updating is not inhibited.
- displays ALL in both locations of the VOR ONLY INHIBIT line.

Push – when OFF is displayed in large font:

- changes ON to large font and OFF to small font
- enables VOR/DME updating to the FMC
- deletes the ALL from the VOR ONLY INHIBIT line.

### Fix Information Page

Two identical fix information pages are used to create fixes and waypoints for the HSI. Some of the created waypoints can be copied into the route.

The bearing information is presented in magnetic or true depending on the position of the heading reference switch or airplane location. Refer to FMC Polar Operations, Flight Management Navigation, section 31.

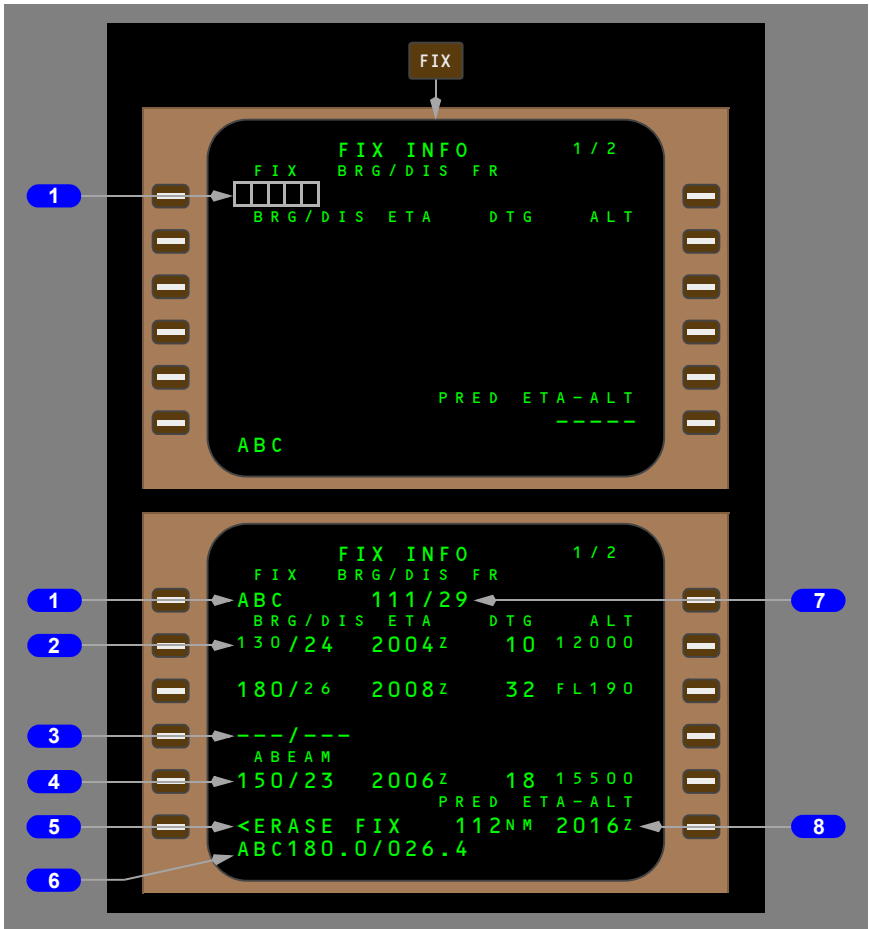

#### 1 FIX

Before entry of a name or identifier, boxes displayed and most data lines are blank. Valid entries are airports, nav aids, and waypoints from the navigation database. The selected fix displays on the HSI and is highlighted by a green circle.

---

## **2 Bearing/Distance (BRG/DIS), ETA, DTG, ALT**

Valid entries are XXX/YYYY.Y:

- decimal values can be omitted
- leading zeros can be omitted for distance entries
- distance only entries must start with a slash (/).

Distances from the fix display on the HSI as a circle around the fix. When the circle intersects the active route, the ETA, DTG, and predicted altitude at the intersection display for the closest of the two intersections.

Bearings from the fix display on the HSI as radial lines from the fix.

When the bearing intersects the active route, the ETA, DTG, and predicted altitude at the intersection display.

ETA – displays the estimated time of arrival to the intersection point.

DTG – displays the distance to go to the intersection point.

ALT – displays the predicted altitude at the intersection point.

Push – copies the fix place/bearing/distance into the scratchpad. This fix can be placed in the route on a LEGS or RTE page as a waypoint.

## **3 Bearing/Distance (BRG/DIS) – Dashes**

Enter a bearing, distance, or both bearing and distance from the fix. A bearing and distance from the fix displays on the HSI as a waypoint fix point. ETA, DTG, and predicted do not display.

## **4 ABEAM**

Displays ABEAM prompt.

Push – displays bearing and distance from the fix perpendicular to the nearest segment of the flight plan path, and ETA, DTG, and altitude at the intersection point.

Second push – copies the fix place/bearing/distance into the scratchpad. This fix can be placed in the route on a LEGS or RTE page as a waypoint.

## **5 ERASE FIX**

Push – removes all fix data from the page and the HSI.

## **6 Route Intersection Point Copied**

Pushing the line select key for one of the BRG/DIS entries copies the fix place/bearing/distance definition into the scratchpad. This fix can be placed into the route on a LEGS page as a waypoint.

### 7 Bearing/Distance From (BRG/DIS FR)

Displays the bearing and distance of the airplane from the fix.

### 8 Predicted Distance to ETA or Altitude (PRED ETA-ALT)

Valid entry is altitude, flight level, or time. Time entry must be followed by "Z".

Entering an altitude or flight level displays the predicted along track distance and altitude or flight level on this line. The predicted airplane position displays on the HSI route line as a green circle with the entered altitude/flight level or time.

## In-Flight Position Update

FMC position update can be accomplished on the POS REF 2/4 page in flight.



### 1 UPDATE ARMED

Pushing the ARM prompt arms the position update function. ARM changes to ARMED. Each of the position update sources have a NOW prompt.

**2 NOW**

Push – to update the FMC position from the desired source. The FMC position is changed to the position of the selected system. If a valid source with a more accurate position (smaller ACTUAL) exists, the FMC position will quickly return to the most accurate position source.

## Route and Waypoint Data

### Route Data Page

The route data page displays progress data for each waypoint on the ACT RTE X LEGS page. This page is available only for the active route.

The ETA and calculated fuel remaining are displayed for each waypoint. Manual entry is not possible. This page also allows access to the WIND page.

One page shows data for five waypoints.



**1 Waypoint (WPT)**

Displays identifier for waypoint.



**2** ETA

Displays ETA for waypoint.

**3** FUEL

Displays the FMC calculated fuel remaining at the waypoint.

**Note:** ETA and estimated fuel calculations assume a direct flight across route discontinuities.

**4** WIND Page Prompts

Push – selects WIND page for the selected waypoint.

A "W" next to the prompt indicates that wind data has been entered on the wind page for that waypoint.

**5** LEGS

Push – displays RTE LEGS page.

**Wind Data**

The FMC uses wind data to improve performance calculation accuracy.

The FMC applies the first entered wind to all waypoints in the flight plan. Wind data includes altitude and direction/speed.

Wind data entered at another waypoint changes the wind only for the waypoints down track from that waypoint either to the end of the track, or to the next entered wind. Therefore, enter winds for waypoints closest to the airplane first, then enter winds for waypoints further down track.

For example: at FL 350, 100°/085 is entered at waypoint OED. All waypoints in the route have the OED wind data. Then, additional wind data entered at OAK changes the wind data at OAK and through the end of the route.

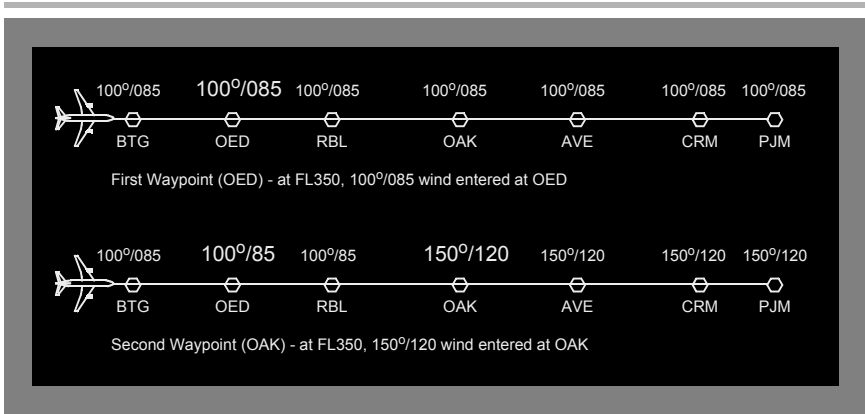

Entered winds are mixed with sensed winds for performance calculations. The FMC uses entered winds for predictions far ahead of the airplane and sensed winds close to the airplane. The FMC mixes these winds for predictions in between. Sensed winds are displayed on the HSI and on progress page 2.

## Wind Page

The wind page is used to enter forecast winds and temperatures at specific altitudes for specific waypoints to enhance VNAV performance. The FMC calculates step climb points based on the wind effect.

The wind page displays waypoint wind data for one to four altitudes per waypoint. This data can be uplinked or manually entered.

The altitudes are entered first. The altitudes can be entered in any order and are sorted and displayed in ascending order.

Wind speed and direction are entered for the specific altitudes.

OAT can be entered for any one altitude. The FMC calculates the temperature for the entered altitudes using the standard lapse rate.



**1 Page Title**

Displays ACT XXXXX, where XXXXX is the waypoint for which the wind page was selected.

When a route is being modified, MOD is shown in the page title. If ACT is displayed when the wind page is first accessed, entry of wind data caused MOD to be displayed. Wind entries must be executed.

**2 Altitude (ALT)**

Enter altitude or flight level for wind entries. Altitude data entry is possible only on line 1L.

After altitude entry, data is sorted in ascending order in lines 1 through 4. Dashes display on right side of line for wind direction and speed entry.

When all four lines have data, one must be deleted before new data can be entered. Entered altitudes are propagated to all wind pages.

**3 Altitude/Flight Level Data**

Displays the altitude or flight level for wind entries. Data entered on 1L is displayed on lines 1 through 4 in ascending order. Altitude entry is not possible in lines 2L through 4L.

Calculated OAT based on standard lapse rate from the entry made on the ALT/OAT line are display in small font.

**4 ERASE**

Push – removes modified data.

**5 Direction and Speed (DIR/SPD)**

Displays dashes after altitude/flight level entry in the ALT line. Enter predicted wind direction and speed for the altitude.

Values propagate to other waypoint winds. Propagated values display in small font.

Manual entries display in large font.

**6 Altitude/Outside Air Temperature (ALT/OAT)**

Enter altitude and OAT. The altitude for OAT does not have to be one of the wind altitudes. The FMC uses standard lapse rate to calculate the temperature at the other altitudes.

Entries must be executed.

**7 Route Data (RTE DATA)**

Push – displays the RTE DATA page.

---

## Progress Pages

The progress page displays general flight progress data.

### Progress Page 1

Page one of the progress pages displays general data about:

- waypoints (active and next)
- FMC speed
- destination
- next VNAV profile point.

The page title displays the company flight number entered on the RTE page.

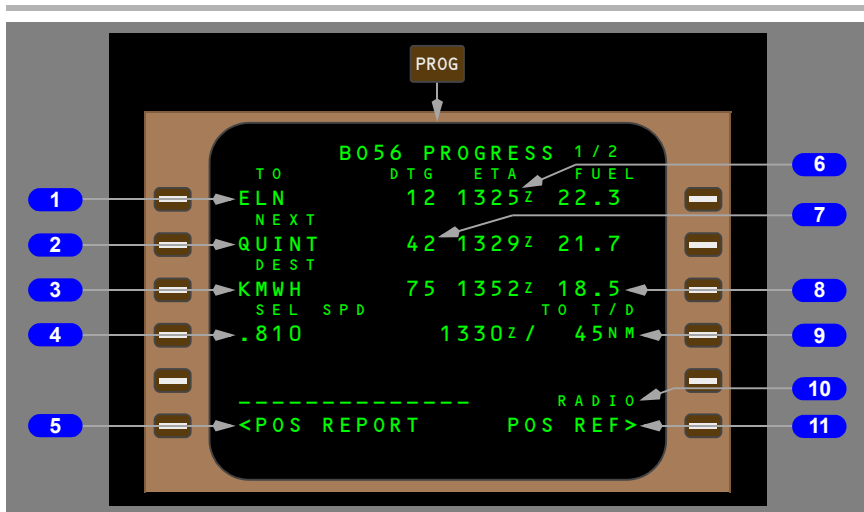

**1 TO**

Active waypoint is displayed.

Can not be modified.

**2 NEXT**

Waypoint after TO waypoint is displayed.

Can not be modified.

**3 Destination (DEST)**

When the page is selected the active route destination is displayed. Any waypoint or airport in navigation database can be entered over the destination.

The line titles are:

- DEST – performance predictions to destination. Default display.
- DIR TO FIX – when entered waypoint is not in flight plan. Data is based on flying present position direct to the waypoint.
- EN ROUTE WPT – when entered waypoint is in flight plan. Line data are based on flying the flight plan route to the waypoint.
- MOD – a modification has been made on another page. Performance predictions include modification.

Entries do not modify the active route and are deleted when all CDUs are changed to a different page.

#### **4 Selected Speed (SEL SPD)**

Displays the FMC active command speed.

The active speed mode is the same as on the performance page, unless changed by the MCP or a limit. The speed modes are:

- LRC SPD – long range cruise speed
- ECON SPD – economy speed
- SEL SPD – selected speed manually entered on the CDU
- LIM SPD – speed is limited by VMO, MMO, flap limit, or buffet limit
- MCP SPD – MCP speed entered on the MCP IAS/MACH indicator
- EO SPD – engine out speed
- CO SPD – engine out operations at airline specified engine out company speed

#### **5 Position Report (POS REPORT)**

Push – displays the POS REPORT page.

#### **6 ETA**

Estimated time of arrival at waypoint or destination.

#### **7 Distance To Go (DTG)**

Distance to go to waypoint or destination.

#### **8 FUEL**

Estimated fuel remaining at waypoint or destination.

#### **9 TO Top Of Descent (T/D)**

ETA and DTG to next VNAV profile point.

The line title and data change for other phases of flight. Other line titles:

- TO T/C – top of climb data
- TO STEP CLIMB – step climb data
- TO E/D – end of descent data
- LEVEL AT – time and distance to level off in engine out mode.

#### **10 Navigation Updating Mode**

Displays the current FMC position updating source. Possible displays are:

- GPS
- RADIO
- IRS
- LOC–GPS
- LOC–RADIO
- LOC

### 11 Position Reference (POS REF)

Push – displays the position reference page.

### Progress Page 2

Progress page two contains:

- wind data
- true airspeed
- fuel data
- track error data.
- static air temperature.

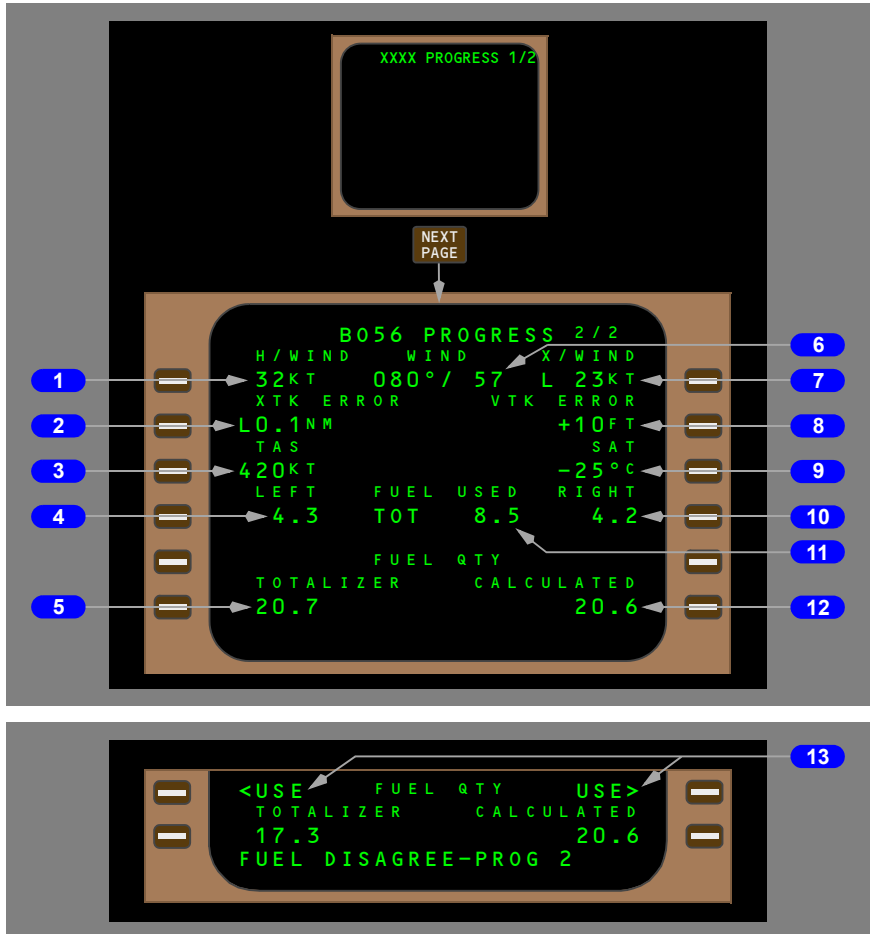

### 1 Headwind (H/WIND), Tailwind (T/WIND)

Displays headwind (H/WIND) or tailwind (T/WIND) component relative to the airplane heading.

**2 Crosstrack Error (XTK ERROR)**

Displays crosstrack (XTK) error in nautical miles left or right of the active route.

**3 TAS**

Displays airplane true airspeed.

**4 LEFT FUEL USED**

Displays fuel used by left engine sensed by fuel flow meters.

**5 Fuel Quantity (QTY) TOTALIZER**

Displays total fuel quantity from the fuel system quantity processor.

The fuel remaining line displays two independent fuel remaining values, TOTALIZER and CALCULATED. They can be compared to validate FMC calculations.

**6 WIND**

Displays current wind direction and speed referenced to true north.

**7 Crosswind (X/WIND)**

Displays left (L) or right (R) crosswind component relative to airplane heading.

**8 Vertical Track Error (VTK ERROR)**

Displays vertical path (VTK) error above (+) or below (–) vertical path.

**9 Static Air Temperature (SAT)**

Displays outside static air temperature.

**10 RIGHT FUEL USED**

Displays fuel used by right engine sensed by fuel flow meters.

**11 FUEL USED Total (TOT)**

Displays sum of the LEFT and RIGHT fuel used values.



**12 FUEL Quantity (QTY) CALCULATED**

Displays fuel remaining as calculated by the FMC with these methods:

- before engine start, fuel quantity calculated by fuel quantity system totalizer
- after engine start, fuel quantity at engine start decreased by EICAS engine fuel flow rate
- after erasing a manually entered fuel quantity (PERF INIT page), resets to totalizer
- after all engines are shutdown, resets to fuel quantity system totalizer.

The fuel remaining line displays two independent fuel remaining values, TOTALIZER and CALCULATED. They can be compared to validate FMC calculations.

**13 USE**

USE prompts display when TOTALIZER and CALCULATED values disagree by a significant amount. The scratchpad message FUEL DISAGREE-PROG 2 is also displayed.

Push – selects method to calculate fuel quantity, either TOTALIZER or CALCULATED.

When one is selected:

- it is used for remainder of flight
- the other fuel calculation method blanks
- scratchpad clears.

---

**Position Report Page**

The position report page displays data for a position report. A data linked position report can be initiated from the page.

The page contains reference data only. Manual entries are inhibited.



**1 Position (POS)**

Waypoint used to report position. This is the previous active waypoint.

The actual time of arrival (ATA) and altitude (ALT) at the waypoint follow the waypoint name.

**2 Estimate (EST)**

The active waypoint is displayed with the ETA to that waypoint.

**3 NEXT**

The waypoint following the active waypoint.

**4 Temperature and Wind (TEMP WIND)**

TEMP displays the OAT in degrees C.

WIND displays the wind direction and speed. Wind direction is shown in degrees true.

**5 Destination ETA (DEST ETA)**

The FMC calculated ETA for the destination is displayed.

**6 Speed (SPD)**

Displays the target FMC speed.

**7 Position Fuel (POS FUEL)**

Displays the fuel on board at the POS waypoint.

Intentionally  
Blank

---

**Introduction**

The descent phase starts at the top of descent point and continues to the end of descent point. Planning for the descent phase starts during cruise.

The approach phase starts at the end of descent point and continues to touchdown or go-around. When a go-around is accomplished, the FMC enters a modified cruise or approach phase, depending on the route and cruise conditions.

Alternates can be selected at any time. Alternates are available from preflight through all phases of flight and can be updated at any time. Diversion to an alternate can be accomplished during cruise, descent, or approach.

The only automatic page change in the descent/approach phases is the VNAV selected page change, from cruise to descent, at the top of descent.

**Early Descent**

Early descent is commenced before reaching the top of descent. The description of early descent options and functions is in Section 42, FMC Cruise.

---

**Descent**

During descent, LNAV progress is managed using the RTE LEGS page, as in the cruise phase. VNAV descent management is accomplished primarily on the DES page.

Other pages which support descent are:

- DESCENT FORECAST page – to enter forecast wind data to aid descent planning
- OFFPATH DES page – to analyze descent performance with and without the use of speedbrakes
- ALTN page – to manage the selection of alternate airports and diversions.

**Descent Page**

The descent page is used to monitor and revise the descent path. Descent speed modes are economy (ECON) and fixed speed (SEL). The default VNAV descent mode is ECON. A fixed speed descent is flown when speed intervention is used or a speed is entered on the DES page. The descent page is no longer available after the end of descent.

The page title includes the VNAV speed mode. The ECON mode controls descent speed at the economy speed until reaching a lower speed restriction. The fixed speed mode controls descent speed until a lower speed restriction is reached.

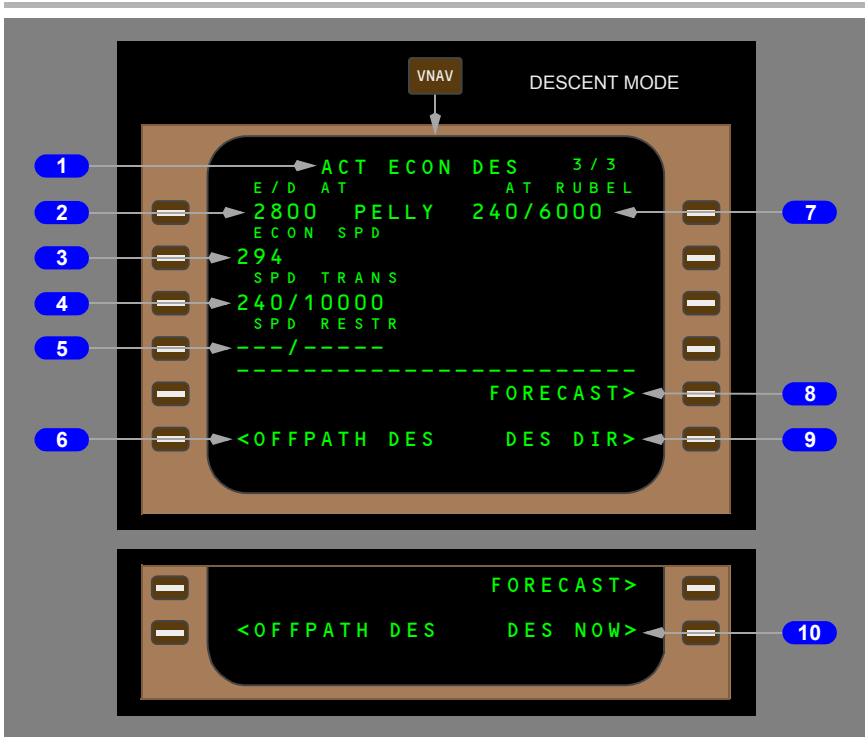

## 1 Page Title

The title usually shows ECON during descent. Fixed speed descents modify the title.

The page title shows the type of descent:

- ECON – speed based on a cost index
- LIM SPD – speed based on airplane configuration limiting speed
- MCP SPD – MCP speed intervention is selected
- XXXKT – fixed CAS descent speed profile
- M.XXX – fixed Mach descent speed profile
- ACT – prefix shown when descent phase is active
- MOD – prefix shown when descent phase is active and the flight plan is modified.

Reasons for fixed descent speeds are:

- waypoint speed constraints
- an altitude constraint associated with a speed constraint
- a speed transition
- a flight crew entered selected speed (SEL SPD).

## **2 End Of Descent At (E/D AT)**

Shows the end of descent altitude and waypoint.

The end of descent point is a waypoint in the descent phase with the lowest altitude constraint.

Blank if no E/D point exists.

## **3 Economy Speed (ECON SPD), Selected Speed (SEL SPD)**

Shows the current target descent speed.

ECON SPD –

- economy speed based on cost index
- shows CAS or Mach.

SEL SPD –

- shows when intermediate level off required below an existing speed constraint
- shows when flight crew enters speed
- CAS or Mach value may be entered.
- page title changes to ACT XXXKT DES or ACT M.XXX DES
- <ECON prompt appears at line 5L to allow selection of economy descent speed

## **4 Speed Transition (SPD TRANS)**

The transition speed is usually 10 knots less than the destination airport limiting speed from the navigation database. When no airport limit speed exists, the default speed of 240 knots is shown. The transition altitude is the point that the transition speed is active for the destination airport. When no altitude exists in the navigation database, the default of 10,000 feet is shown.

Blanks when the transition has occurred.

Can be deleted.

## **5 Speed Restriction (SPD RESTR)**

Speed restrictions not associated with specific waypoints are manually entered on this line.

Dashes before entry by flight crew.

Valid entry is a CAS and altitude (example 240/8000).

An entry creates a modification.

## **6 Off Path Descent (OFFPATH DES)**

Push – shows the OFFPATH DES page.

**7 AT XXXXX**

Shows the next waypoint constraint from the RTE LEGS page.

Line title shows:

- AT XXXXX (the waypoint identifier)
- HOLD AT XXXXX
- AT VECTORS
- AT (INTC).

The constraint is speed/altitude. Blank when no constraint exists.

Can be deleted on this page.

VNAV commands the lesser of constraint speed or present performance speed.

**8 FORECAST**

Push – shows the DESCENT FORECAST page.

**9 Descend Direct (DES DIR)**

Push – deletes all waypoint altitude constraints between the airplane altitude and the MCP altitude.

Shown in descent phase with altitude constraint between airplane and E/D.

**10 Descend Now (DES NOW)**

Shown when the descent phase is not active.

Push –

- starts a 1250 feet per minute descent schedule until intercepting the planned descent path
- activates the FMC descent phase.

## **Descent Forecast Page**

The descent forecast page is used to enter wind data for descent, and the altitude at which anti-ice use is anticipated for more accurate descent path calculation.

The primary entries are wind direction and speed for up to four descent altitudes, and the altitude that anti-ice is turned on.





### 1 Transition Level (TRANS LVL)

Shows the transition level.

The transition level can be specified by the arrival procedure. The default transition level is FL 180.

Above transition level, altitudes are in flight levels. Below transition level, altitudes are in thousands of feet.

Valid entry is an altitude or flight level.

### 2 Altitude (ALT)

Enter altitude of forecast wind data.

Altitudes and flight levels can be entered in any order. Entries are not sorted.

Execute not necessary.

### 3 Thermal Anti-Ice On Altitude (TAI/ON ALT)

Enter the altitude where anti-ice is first turned on during the descent. The FMC calculates the descent profile based on the higher thrust caused by thermal anti-ice operation below this altitude.

**4 Wind Direction/Speed (WIND DIR/SPD)**

Enter the wind direction/speed for the specified altitude. Initial entry must have wind direction and speed, subsequent entries may have one or the other.

Execute not necessary.

**5 Descent (DES)**

Push – shows the DES page.

**Offpath Descent Page**

The offpath descent page allows the analysis of descent performance off the present route of flight, direct to a selected waypoint. Data entered on the page shows clean and drag descent ranges on the page and on the HSI. The ranges are based on an entered waypoint and altitude constraint. The range can be used to determine if the altitude constraint can be met in a direct descent to the waypoint.

The FMC puts the last descent waypoint with an altitude constraint into DES TO.

The ECON SPD, SPD TRANS, SPD RESTR, and DES data are the same as the DES page.



## **1 Descend To (DES TO)**

The waypoint for a direct-to descent. Usually, this is the E/D waypoint from the active route. Manual entry of waypoints on or off of the route are allowed. The DTG calculations are for a descent direct to the selected waypoint.

When within 150 feet of the DES TO altitude for a waypoint other than the E/D waypoint, the display automatically changes the DES TO waypoint to the E/D waypoint from the DES page.

A waypoint is entered for direct-to analysis.

## **2 Distance To Go (DTG)**

Shows the straight line distance to the entered waypoint.

## **3 Speed/Altitude (SPD/ALT)**

Shows the speed/altitude constraint for the entered waypoint.

A manual waypoint entry shows boxes for manual speed and altitude entry.

## **4 TO CLEAN**

Distance to the clean descent circle. The distance is negative when a clean descent is no longer possible.

A clean circle assumes no drag devices are used for descent.

A direct descent to the DES TO waypoint at a SPD/ALT constraint is possible when the airplane is outside the clean circle. The clean circle is shown on the HSI when the DISPLAY prompt is ON.

## **5 TO DRAG**

Distance to the drag descent circle. The distance is negative when a drag descent is no longer possible.

A drag circle assumes speedbrakes are UP for descent.

A direct descent to the DES TO waypoint at a SPD/ALT constraint is possible when the airplane is outside the drag circle. The drag circle is shown on the HSI when the DISPLAY prompt is ON and the airplane is inside the clean circle.

## **6 DISPLAY**

Push – alternates between ON and OFF. The current condition of the display is indicated by the large font.

ON – when ON is displayed in large font, shows the clean and drag circles on the HSI. The drag circle is not shown until the airplane position is inside the clean circle.

OFF – when OFF is displayed in large font, removes the clean and drag circles from the HSI.

Automatically changes to OFF within 150 feet of the waypoint constraint altitude.

## **Engine Out Descent**

There are no specific engine out pages for descent. Use the all engine descent planning features and pages.

---

## **Approach**

During approach, roll and pitch modes usually change to the approach guidance supplied by navigation radios. The FMC continues to calculate and show present position and can supply LNAV and VNAV approach guidance for certain types of approaches when radio navigation is not used.

The RTE LEGS and DESCENT pages are used to manage the airplane until other approach guidance becomes active. Other pages which support approaches are:

- APPROACH REF page – to specify approach flap settings and set the approach VREF speed
- ARRIVALS page – to select arrival and approach procedures
- HOLD page – to manage holding patterns.

Holding is described in this section but it can be used during any phase of flight.

## **Arrivals Page – IFR Approaches**

The arrivals page allows selection of an approach, standard terminal arrival route (STAR), and an arrival transition to the destination airport. This page can also be used to view data about a selected airport that is not the destination. Route 1 and route 2 have separate arrival pages.

The approaches, STARS/profile descents, and transitions are shown and selected on this page.

### **Selecting Options**

Selecting a runway, approach, approach transition, STAR/profile descent, or descent transition option shows <SEL> inboard of the selection, and makes a route modification. The other options within the same category are removed from the list. When the modification is executed, <SEL> changes to <ACT>. Select another page and return to ARRIVALS to show all options; the applicable <SEL> or <ACT> prompts are shown.

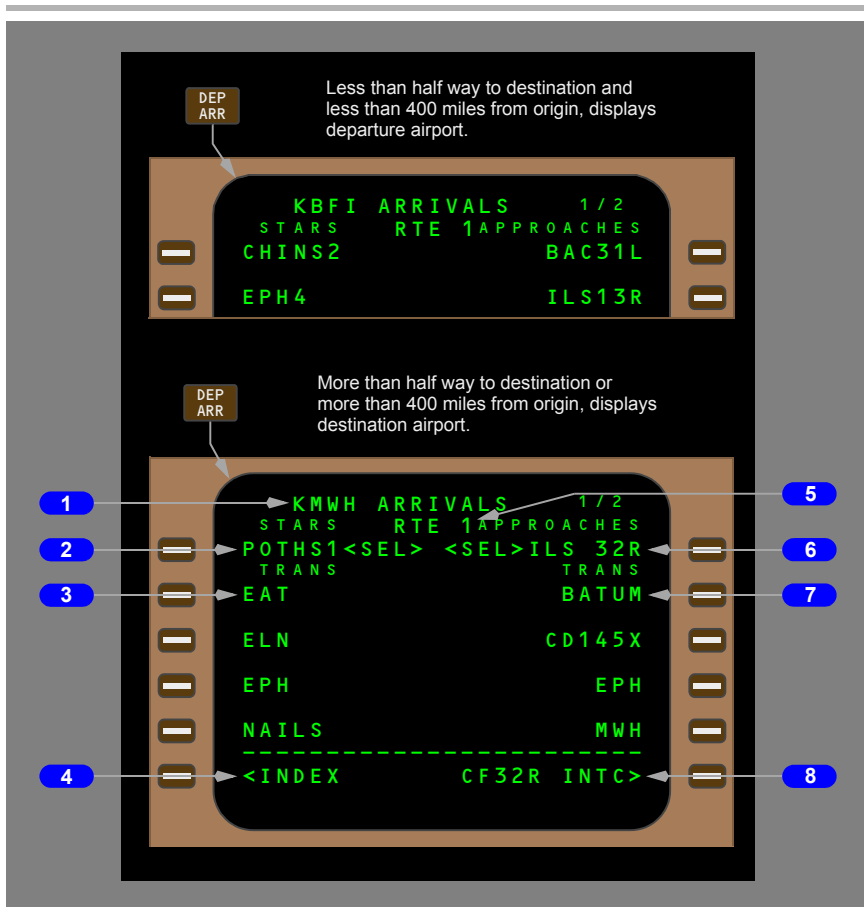

**1 Page Title**

The airport identifier is shown in the title.

Airports with more than 5 runways or STARS produce multiple arrivals pages.

**2 Standard Terminal Arrivals (STARS)**

Lists the STARS and PROFILE DESCENTS for the airport.

STARS are shown first in a list under the STAR line title. Profile descents are listed after the STARS under the PROF DES line title.

When a selection is made the procedures not selected are removed from the page. The selected procedure is listed with <SEL> and a list of compatible transitions is shown.

---

### **3 Standard Terminal Arrivals Transitions (STARS TRANS)**

Lists all the transitions for the selected STAR.

When a selection is made the transitions not selected are removed from the page. The selected transition is listed and marked <SEL>.

### **4 INDEX**

Push – shows the DEP/ARR INDEX page.

### **5 Route 1 (RTE 1)**

Shows the selected route number (RTE 1 or RTE 2).

### **6 APPROACHES**

Lists available approaches and runways for the destination airport.

When a selection is made, other approaches and runways are removed from the page and compatible transitions are listed. The list of STARS and profile descents is reduced to those compatible with the selected approach.

An INTC prompt for the runway of the selected approach also becomes available (see callout #8).

### **7 Approach Transitions (TRANS)**

Transitions are listed when an approach is selected. Shows a list of available transitions to the selected approach.

Approach transitions include:

- IAF
- feeder fix
- fixes which define routing to the FAF.

Selecting an approach without a transition makes a straight-in approach which starts at:

- a charted fix or CFXXX, where XXX is the runway number
- a waypoint 4–8 miles outside the final approach fix.

### **8 Final Approach Fix Intercept (XXXXX INTC)**

Selecting the prompt shows a modified RTE LEGS page with an intercept course to the approach transition fix (usually the IAF) for the selected approach.

## **Vertical Angle Display on the Route Legs Page**

When a runway is selected as part of the active route the vertical angle of the flight path approaching the runway is displayed on the RTE LEGS page.



**1 Glide Path (GP) Angle**

Displays the vertical angle for use by VNAV on the final approach to the runway. If the runway was selected as part of a published approach, the displayed angle will be close to the published glide path angle but may differ slightly.

**Arrivals Page – VFR Approaches**

The arrivals page also allows selection of a VFR approach if the navigation database contains a VFR approach for the selected runway.



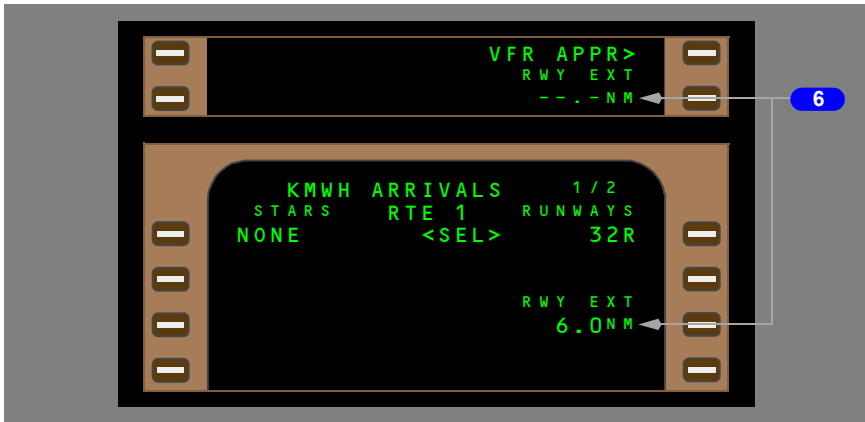
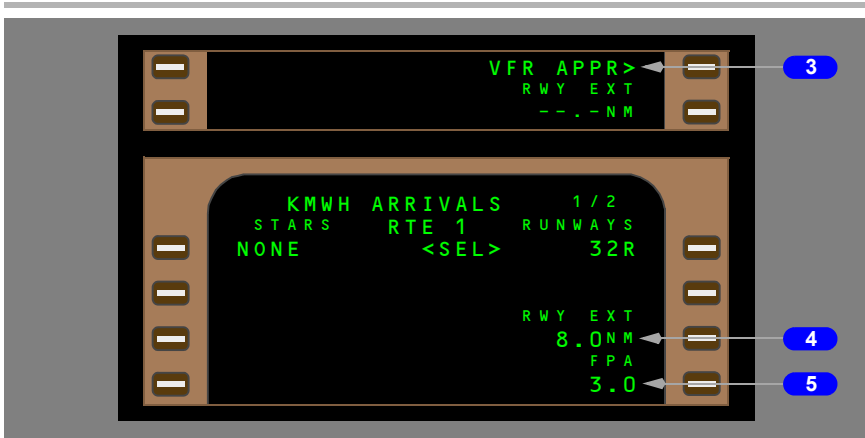

### 1 RUNWAYS

Push – removes approach list and other runways. Displays RWY EXT prompt and VFR APPR prompt in line 2 if a VFR approach is in the navigation database.

The RUNWAYS list for other runways is shown if a runway is not selected.

Example shows runway 32R selected. Change CDU to another page and return to ARRIVALS page to show all arrival procedures.

### 2 ROUTE

Push – shows the active route page.

### 3 VFR Approach (VFR APPR)

Push – makes a transition waypoint, FAXXX at 8 NM and 2000 feet above the runway.



Shown when a VFR approach is in navigation data base for selected runway.  
LNAV and VNAV guidance to the runway is available.

**4 Runway Extension (RWY EXT)**

After VFR APPR is selected, RWY EXT can not be modified.

**5 Flight Path Angle (FPA)**

Shows flight path angle. Shown only after VFR APPR is selected.

Default is 3.0 degrees. Valid entries are from 2.4 to 3.7 degrees.

**6 Runway Extension (RWY EXT)**

Valid entries are from 1.0 to 25.0 miles from the runway threshold.

Entry allowed if VFR APPR is not selected. Entry removes VFR APPR prompt.  
Example shows 6 NM entered.

Makes waypoint RXYYY, where YYY is the runway; example: RX32R. Makes a route discontinuity before and after the waypoint.

**VFR Approach Path**

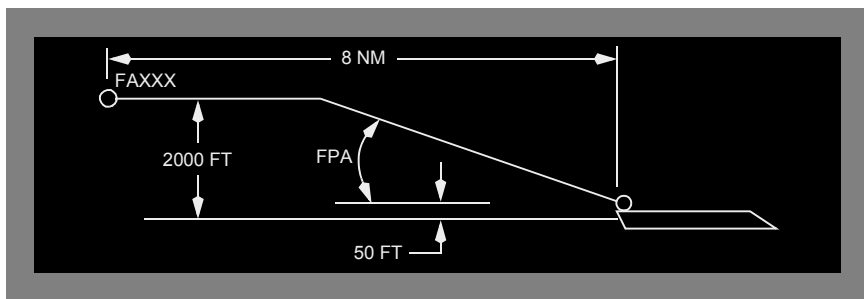

The VFR approach is a level path until the FPA is intercepted. The FPA goes from the FAXXX waypoint altitude to the runway threshold at 50 feet and 170 knots. Default values are shown in RWY EXT and FPA.

**Approach Reference Page**

The approach reference page shows approach planning data and approach reference speed (VREF) selection.

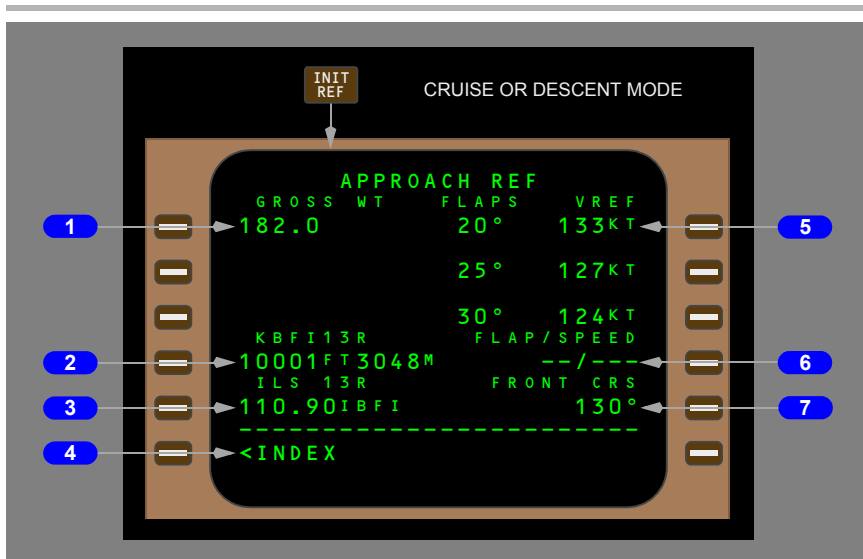

### 1 Gross Weight (GROSS WT)

FMC calculated airplane gross weight is usually shown.

Manual entry is allowed in case the FMC calculated gross weight is unavailable or invalid, or to allow previewing recommended approach speeds at other than the calculated FMC gross weight. The manually entered gross weight is for reference only and is deleted when a different page is selected. Permanent changes to gross weight may only be made on the PERF INIT page.

Shows boxes when gross weight is not available from the FMC.

Valid entry is XXX.X.

### 2 Runway Length

The shown runway reference changes based on route progress. The destination runway is the reference when the present position is more than halfway to the destination or more than 400 NM from the origin airport. The origin airport runway is the reference when less than halfway or less than 400 NM from the origin airport.

Shows the length in feet and meters of the referenced runway.

### 3 ILS

Display is blank prior to entering a destination runway in the active route.

Displays the runway, corresponding ILS frequency and facility identifier from the navigation database for the runway shown.

#### **4 INDEX**

Push – shows the INT/REF INDEX page.

#### **5 FLAPS VREF**

Shows the calculated reference speed for flaps 20°, 25°, and 30°. A gross weight is necessary for VREF speed calculation.

Push the applicable line select key to select the correct VREF speed and enter it into the FLAP/SPEED line to display the correct reference speed on the ADI speedtape.

The display is blank until a gross weight is shown.

#### **6 FLAP/SPEED**

Enter the flap position and VREF speed for landing. The value is normally entered from the scratchpad after selection from the desired FLAPS VREF line.

The VREF speed is shown on the ADI speedtape.

Deletion of the data removes VREF from the ADI speedtape.

#### **7 FRONT Course (CRS)**

Displays the front course for the ILS and runway shown to the left.

---

### **Alternate Airport Diversions**

Alternate page helps the flight crew find the best alternate airport. The page has four airports shown in an ETA sequence. There is a prompt for each airport on the list to select the ALTN XXXX page which has more information and routing options for the airport. (XXXX is the identifier for the airport).

#### **Alternate Page**

The alternate page displays a list of alternate airports. An alternate airport can be selected from this page to change the flight plan destination.

The page displays a list of up to four alternate airports sorted in order of the ETA to the airport while airborne. The source of alternate airports can be:

- automatic selection from the navigation database
- manual entry.

Alternate airports automatically selected from the navigation database are displayed in small font. The presently selected alternate airport is shown on the HSI map in normal airport symbology. All four alternate airports are shown on the HSI in the plan mode.

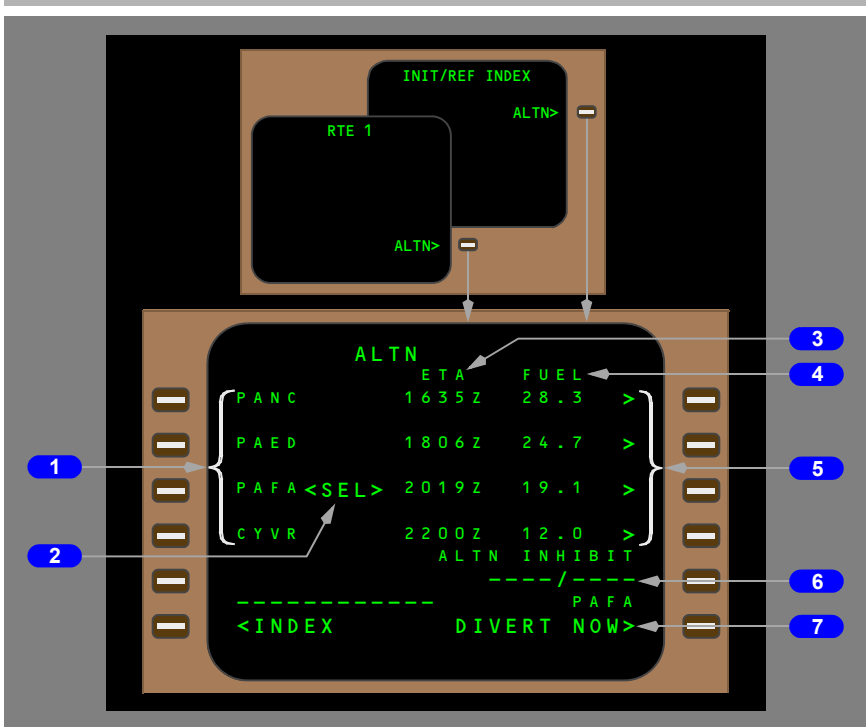

**1 Alternate Airports**

Displays the identifier of four alternate airports in ETA order when airborne.  
 Displays the identifier of four alternate airports in distance order when on the ground.

Valid manual entry is an airport from the navigation database. A manual entry replaces the alternate where the entry is made and is shown in large font. After entry, the airports are resequenced according to ETA and the FMC selected airport with the last ETA is removed.

Use the DELETE function or overwrite a manually entered alternate to remove it. Manually entered airports will not be removed by the FMC.

**2 Selected (<SEL>), Automatically Selected (<A>)**

<SEL> indicates a manually selected alternate airport.

A manual selection of an alternate airport is made by pushing the line select key left of the airport identifier with nothing in the scratchpad.

When there is no manually selected alternate the FMC automatically selects the alternate airport with the earliest ETA. Automatically selected alternates are indicated by <A> next to the airport identifier.

The selected alternate identifier is shown in the line title of the DIVERT NOW prompt.

Entering a new airport into the list deletes the last airport in the list. After entry, the airports are rearranged in ETA sequence. Manually entered airports are shown in large font and can be removed using the DELETE function.

Use the DELETE function to remove the <SEL> from a manually selected alternate. The automatic selection function selects a new alternate.

### **3** **ETA**

Displays the alternate airport ETA.

ETA is calculated based on the routing, altitude, and speed shown on the XXXX ALTN page. ETA is blank when the airplane is on the ground.

### **4** **FUEL**

Displays the alternate airport predicted arrival fuel.

Predicted arrival fuel is calculated based on the routing, altitude, and speed shown on the XXXX ALTN page. The message UNABLE FUEL is shown in the FUEL column if the predicted arrival fuel is less than zero.

Fuel values are blank when the airplane is on the ground.

### **5** **Alternate Select**

Selects the XXXX ALTN page, which contains more data about the specific airport.

### **6** **Alternate Inhibit (ALTN INHIBIT)**

An airport will not be one of the four alternate airports if entered into the alternate inhibit line.

One or two airports can be manually entered.

Valid entries are airports from the navigation database.

### **7** **DIVERT NOW**

The DIVERT NOW selection modifies the route to go from the present position to the selected alternate using the route shown on the XXXX ALTN page.

Push –

- makes an LNAV route modification for a divert to the selected alternate
- automatically displays the MOD XXXX ALTN page for the selected alternate
- displays SELECTED in this position on the CDUs not involved with the modification
- blank on ground
- blank in the air when a diversion is not permitted.

The DIVERT NOW selection changes the display to the XXXX ALTN page for the diversion airport. The details of the route can be confirmed or modified before the diversion is executed.

Execution of the diversion:

- changes the route destination airport
- includes the route modification into the active flight plan
- deletes all parts of the original route that are not part of the diversion
- if a descent path exists, deletes all descent constraints (the scratchpad message DESCENT PATH DELETED is shown when DIVERT NOW is selected).

After a divert is executed the XXXX ALTN page is not updated until all CDUs are selected off of the XXXX ALTN page.

## **XXXX Alternate Page**

Each of the four alternate airports shown on the ALTN page 1/2 have a related XXXX ALTN page. The XXXX ALTN pages show specific data about alternate airports, the route used for a diversion, and the conditions upon which the ETA and fuel calculations are based. All data on the page is related to the alternate airport shown in the page title.

Three route options to the airport can be selected:

- DIRECT TO – direct to alternate
- OFFSET – flight plan route with an offset
- OVERHEAD – flight plan route to a waypoint then direct to alternate.

The selected route option is identified by <SEL>. ETA and fuel remaining are calculated based on the selected option. Selection of a route option for one alternate selects the same route option for the other three alternates.

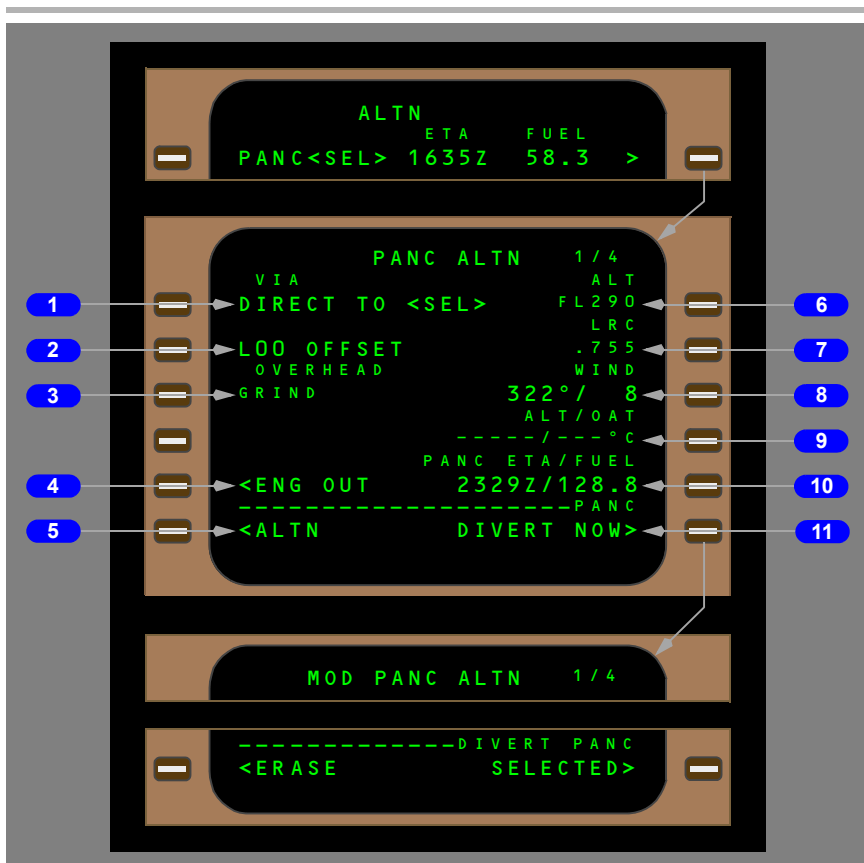

### 1 VIA DIRECT TO

Push – selects present position DIRECT TO alternate route option.  
 All flight plan waypoints are deleted.

### 2 VIA OFFSET

Push –

- with scratchpad empty, selects OFFSET route option
- with offset data in scratchpad, enters offset data. Does not select option.

Entry and exit to the offset is the same as for the RTE page offset. All flight plan waypoints are kept.

### **3 VIA OVERHEAD**

Push –

- with scratchpad empty, selects OVERHEAD option
- with overhead data in scratchpad, enters overhead data. Does not select route option.

Displays active waypoint in flight plan.

The waypoints up to the selected or entered overhead waypoint are kept, then routing is direct to the alternate airport. All waypoints after overhead waypoint are deleted.

Enter any waypoint in the active or modified route.

### **4 Engine Out (ENG OUT)**

This prompt performs the same function as described on the cruise page in the FMC Cruise section. It can be selected before or after the diversion is selected.

### **5 Alternate (ALTN)**

Push – displays the ALTN 1/2 page.

### **6 Altitude (ALT)**

Entry of any valid altitude or flight level into this line causes a recomputation of ETA and arrival fuel. Altitude entries do not become part of the diversion modification. Altitude entries apply to all four alternates.

Displays the altitude for which ETA and arrival fuel are calculated.

The scratchpad displays the message UNABLE ALT, if the entry is above maximum altitude or the top of climb point for divert is after top of descent point for divert.

### **7 Speed**

Entry of speed or Mach number into this line causes a recomputation of ETA and arrival fuel. Speed entries do not become part of the diversion modification. Speed entries apply to all four alternates.

Speed modes available are:

- ECON (economy)
- LRC (long range cruise)
- EO (engine out)
- EO LRC (engine out long range cruise)
- CO (company speed)
- any CAS or Mach.



**8 WIND**

Entry of data into these lines causes a recomputation of ETA and arrival fuel. A separate wind entry may be made for each of the four alternates.

Displays the estimated average wind for the divert route.

Valid entry is a direction in degrees true/speed in knots from 1 to 999.

**9 Altitude/Outside Air Temperature (ALT/OAT)**

Entry of data into these lines causes a recomputation of ETA and arrival fuel. A separate ALT/OAT entry may be made for each of the four alternates.

Displays the OAT for a specific altitude.

Valid entry is an altitude/temperature in degrees C.

**10 Alternate Airport ETA/Fuel (XXXX ETA/FUEL)**

Displays the calculated airport ETA and arrival fuel based on the selected route, altitude, and speed shown on this page.

**11 XXXX DIVERT NOW**

This prompt performs the same function as described on the ALTN 1/2 page.

**Note:** After a divert is executed, the XXXX ALTN page data is not updated until all CDUs change to a page other than the XXXX ALTN page.

---

## **Holding**

The FMC computes holding patterns with constant radius turns based on current wind and FMC commanded airspeed. The pattern size is limited to FAA or ICAO protected airspace. In LNAV, the AFDS tracks the holding pattern using up to a 30 degree bank angle. Strong winds or airspeed in excess of FAA or ICAO entry speeds may result in the airplane flying outside the protected airspace.

With LNAV active before sequencing the holding fix, holding pattern entries are determined by the following:

The entry method used (parallel, teardrop, or direct) is determined by

- airplane track, not heading or direction from which the active route approaches the holding pattern.
- the airplane flies the initial outbound leg a computed distance from the holding fix, rather than a specific time. The computed distance is a function of the command airspeed and computed wind at the time the holding pattern becomes active

- teardrop entries use a 40 degree offset angle
- parallel and teardrop entries may cause the airplane to fly beyond the displayed holding pattern; however, the airplane remains in protected FAA or ICAO limits.

## Hold Page (First Hold)

The hold page is used to enter a holding pattern into the route.

When the flight plan does not have a holding pattern, push the HOLD function key to show the RTE X LEGS page with the HOLD AT line.

Two versions of the hold page are possible:

- an airway or procedure holding pattern
- a flight crew–entered holding pattern.

The holding page displays actual or default data about the holding pattern.

Entries make route modifications, which can be erased or executed.

Active holding patterns are magenta on the HSI.



## **1 HOLD AT**

When the HOLD function key is pushed and no holding pattern exists in the route, the RTE LEGS page displays prompts to enter the holding fix. Enter the holding fix to show the RTE X HOLD page.

Normally a route waypoint is entered as the holding fix. If a waypoint that is not part of the active route is entered the scratchpad message HOLD AT XXX appears where XXX is the entered waypoint. The holding fix can then be inserted in the route in the proper sequence.

## **2 HOLD AT Present Position (PPOS)**

Selects the airplane present position as the holding fix.

## **3 Holding FIX**

Displays the holding fix.

## **4 Quadrant/Radial (QUAD/RADIAL)**

The holding quadrant and radial are entered.

Valid entry is X/XXX, XX/XXX, or /XXX (example NE/040).

Automatically changes INBD CRS/DIR to agree.

## **5 Inbound Course/Direction (INBD CRS/DIR)**

Displays the holding inbound course and turn direction.

Valid entry is XXX (inbound course), XXX/X (inbound course/turn direction), /X or X (turn direction).

Automatically changes QUAD/RADIAL to agree.

## **6 LEG TIME**

Default display is 1.0 MIN (minute) at or below 14,000 feet or 1.5 MIN above 14,000 feet.

Displays — if a LEG DIST is entered.

Valid entry is X, X.X, or .X in minutes from 0.1 to 9.9.

When climbing/descending through 14,000 feet with VNAV engaged and the SPD/TGT ALT on line 1R displayed in large font, the FMC adjusts leg time (1.0 MIN at or below 14, 000 feet; 1.5 MIN above 14, 000 feet).

## **7 Leg Distance (LEG DIST)**

Default display is —. — NM if no leg distance has been entered or if a LEG TIME is entered

Valid entry is X.X, XX.X, or .X.

**8 ERASE**

Erases all FMC modifications.

**9 Speed/Target Altitude (SPD/TGT ALT)**

Waypoint holding fix speed/altitude constraint from the RTE LEGS page.

Manual entries are in large font.

During cruise, an altitude entry below cruise altitude activates the descent page, unless a new cruise altitude is entered. Altitude entry must be at or below cruise altitude.

A speed entry requires an altitude constraint.

**10 FIX ETA**

Displays the ETA to the next passing of the holding fix.

**11 Expect Further Clearance Time (EFC TIME)**

Enter the expect further clearance time to enable accurate fuel and ETA predictions after the hold.

**12 Hold Available (HOLD AVAIL)**

Displays calculated holding time available before requiring reserve fuel to reach the destination.

**13 BEST SPEED**

Displays the best holding speed for the airplane gross weight, altitude, and flap setting.

**Note:** May exceed ICAO limit speed.

## Hold Page (Existing Hold)

When one or more holding patterns are already in the route, push the HOLD key to show the hold page for the first holding pattern. Holding parameters can be monitored and changed on this page. New holding patterns are added using the NEXT HOLD prompt.



### 1 NEXT HOLD

Push = displays a new hold page for a new holding pattern entry.

### 2 EXIT HOLD

Push =

- arms a return to the holding fix via the inbound course for holding pattern exit
- EXIT ARMED displayed
- EXEC light illuminated.

When the EXEC key is pushed, the airplane will cross the holding fix and exit holding. If executed when outbound in the holding pattern the airplane will immediately turn inbound and exit holding when the fix is crossed.

Intentionally  
Blank

---

**Introduction**

The CDUs can be used as an alternate navigation system if both FMCs fail. The CDUs perform lateral navigation computations. LNAV and VNAV are not available.

During normal FMC operation, all system capabilities are contained within the FMCs. During alternate navigation operation, the CDUs use their own internal memory and computing capability.

Each CDU performs its calculations based on inputs from its own IRS and provides information for display independent of the other CDU. Each CDU can display its route on its respective HSI in the map mode without database symbology.

---

**Alternate Navigation Waypoints**

The CDUs do not have a performance or navigation database. The CDUs continuously load the active route from the FMC. If both FMCs fail, the CDUs keep flight plan waypoints except for conditional waypoints, offsets, and holding patterns. Waypoints which are part of the route when the FMCs fail can be referenced by either their identifier, or latitude and longitude.

New waypoints can only be entered as latitude and longitude. This includes waypoints the flight crew has deleted from the CDU. Complete departure or arrival/approach procedures cannot be manually entered.

**Waypoint Operations**

Waypoint operations include:

- add new waypoints (latitude/longitude entry only)
- remove existing waypoints
- change the sequence of existing waypoints
- connect discontinuities.

---

**Alternate Lateral Navigation**

All CDU calculations are based on a great-circle course between waypoints.

## Route Changes

Route changes are made on IRS LEGS page in almost the same manner as normal FMC operations. All courses between waypoints are direct routes. When the active waypoint is modified, the only navigational choice is present position direct to the modified active waypoint.

The two CDUs operate independently. A route change to one CDU does not change the other one. The route entered in the left CDU can be displayed on the captain's HSI using his NAV source select switch. The route entered in the right CDU can be displayed on the first officer's HSI using his NAV source select switch.

## Course Reference

Each CDU uses its associated IRS for navigation data. The IRS supplies magnetic variation only for the present position. Therefore only the active waypoint course can be referenced to magnetic north. All subsequent courses are referenced to true north.

---

## Alternate Navigation CDU Pages

The alternate navigation system provides two CDU pages:

- IRS LEGS
- IRS PROGRESS

Failure of a single FMC causes the related CDU to display the MENU page. Selecting the operable FMC on the NAV selector switch restores the CDU displays to normal.

If the other FMC fails, the IRS LEGS and IRS PROGRESS pages are available on either CDU via the LEGS and PROG mode select keys. Selecting CDU on the NAV source selectors provides a CDU generated map on the HSI.



## Alternate Navigation Legs Page

This page displays data about each leg of the route. The route can be modified. Waypoint speed and altitude restrictions are not displayed because performance data is not available.

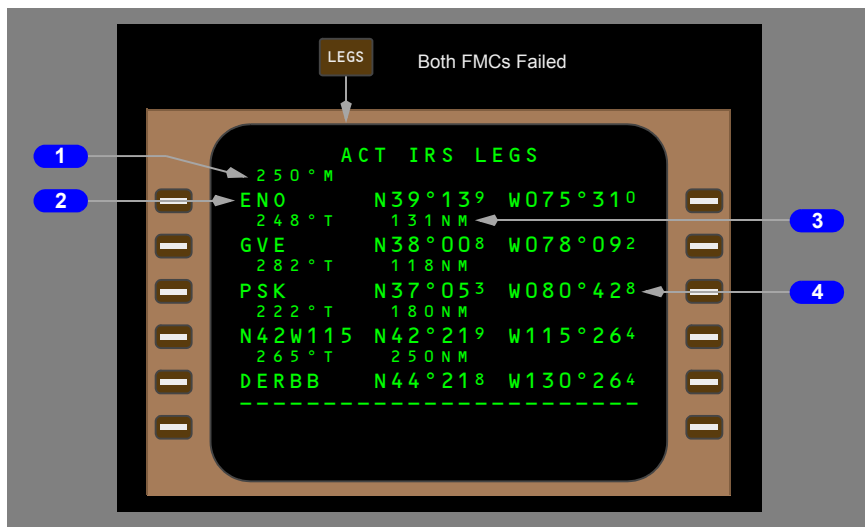

### 1 Leg Direction

Displays course to the waypoint.

Course reference is M for magnetic, T for true.

Active waypoint leg direction can be magnetic or true. Subsequent waypoint leg directions are true.

### 2 Waypoint Identifier

Displays the waypoint by name or latitude/longitude.

Valid entries are waypoint names that were in the route when the FMCs failed, or latitude/longitude for new waypoints.

### 3 Distance to Waypoint

Displays the great circle distance between waypoints.

### 4 Waypoint Coordinates

Displays the waypoint coordinates.

## Alternate Navigation Progress Page

This page shows general data about flight progress.

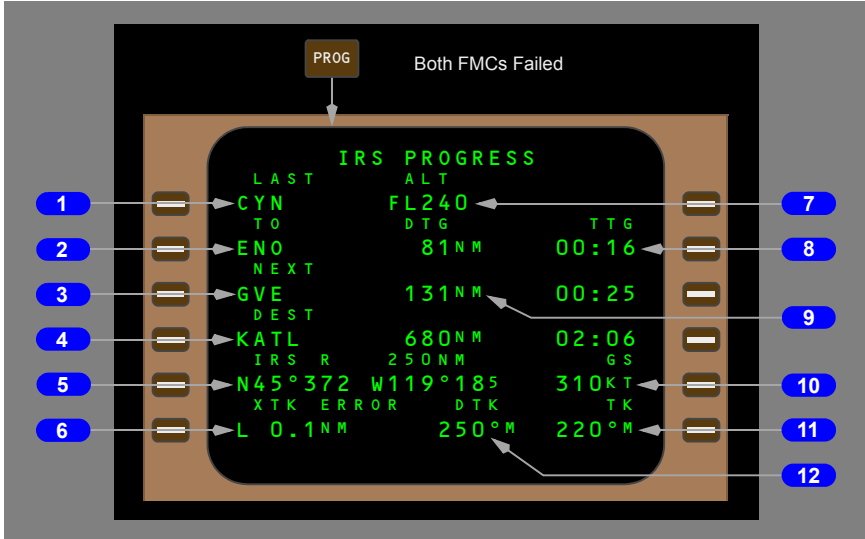

### 1 LAST

Displays the identifier of the last waypoint.

### 2 TO

Displays the active waypoint.

### 3 NEXT

Displays the waypoint after the TO waypoint.

### 4 Destination (DEST)

Displays identifier for route destination waypoint or airport. Any waypoint on or off the route can be entered. Time and distance data temporarily displays for that waypoint.

Display options:

- destination airport identifier; distance and time to go along track to the destination airport
- entry of an existing flight plan waypoint (identifier or latitude/longitude) causes the line title to change to ENROUTE WPT. Time and distance to go are from the present position direct to the new waypoint
- entry of a waypoint not in the flight plan causes the line title to change to DIR TO ALTERNATE. Time and distance to go are from the present position direct to the new waypoint.

**5 Inertial Position (INERTIAL POS)**

Displays IRU present position.

Line title displays IRU source for position.

**6 Cross Track Error (XTK ERROR)**

Displays airplane left or right cross-track error in nautical miles from the active route track.

**7 Altitude (ALT)**

Displays airplane altitude when the LAST waypoint was crossed.

**8 Time to Go (TTG)**

Displays time to go to waypoint or destination.

**9 Distance to Go (DTG)**

Displays distance to go to waypoint or destination.

**10 Ground Speed (GS)**

Displays IRU groundspeed.

**11 Track (TK)**

Displays airplane track angle relative to the true or magnetic reference selected on the HEADING REFERENCE switch.

**12 Desired Track (DTK)**

Displays desired track angle relative to the true or magnetic reference selected on the HEADING REFERENCE switch.

Intentionally  
Blank

# DO NOT USE FOR FLIGHT

## 757 Flight Crew Operations Manual

### Flight Management, Navigation EICAS Messages

### Chapter 11 Section 60

#### EICAS and CDU Messages

The following EICAS messages can be displayed.

Message	Level	Light	Aural	Condition
ATC FAULT	Advisory	ATC FAIL		Selected transponder has failed.
L FMC FAIL R FMC FAIL	Advisory	FAIL		FMC has failed.
FMC MESSAGE	Advisory	FMC		A message is in the FMC scratchpad.
L GPS R GPS	Advisory			Indicated GPS has failed.
GPS	Advisory			GPS system has failed.
L IRS DC FAIL C IRS DC FAIL R IRS DC FAIL	Advisory	DC FAIL		IRS DC backup power has failed and the IRS AC normal power is being used.
L IRS FAULT C IRS FAULT R IRS FAULT	Advisory	FAULT		An IRS fault is detected.
L IRS ON DC C IRS ON DC R IRS ON DC	Advisory	ON DC		Indicated IRS AC normal power has failed and the IRS DC backup power is being used.
UNABLE RNP	Caution  Advisory	FMC  FMC	Beeper	Navigation performance not meeting required accuracy.  Message is a caution if fault occurs when the airplane is in "on approach" mode. Message is an advisory if fault occurs when the airplane is not in "on approach" mode.

---

---

## FMC Messages

FMC messages alert the flight crew to conditions that could degrade the system operation and advise the crew of input errors.

The messages are categorized as:

- alerting messages
- advisory messages

The scratchpad messages display according to their level of importance. A less important message replaces another message in the scratchpad when the CLEAR key is pushed or the condition is corrected.

The FMC light illuminates and the EICAS advisory message FMC MESSAGE displays when there is an FMC alerting message.

Scratchpad advisory messages appear in the scratchpad without an EICAS message or FMC light. All FMC messages illuminate the CDU message (MSG) light. Clear the message or correct the condition to cancel the message.

The message is temporarily removed from the scratchpad when manually entering data. The message returns when the data is removed from the scratchpad.

## FMC Alerting Messages

FMC alerting messages:

- display in the CDU scratchpad
- illuminate the amber FMC light on the instrument panel
- cause the EICAS advisory message FMC MESSAGE to display
- illuminate the CDU message light (MSG).

Use the CLEAR key or correct the condition responsible for the message to remove the message.

CHECK AIRLINE POLICY – after loading a new airline modifiable information file, the FMC determines a parameter is invalid. The FMC uses the default value. This is a maintenance function.

CHECK ALT TGT – VNAV active and the airplane is between the MCP and FMC altitudes. VNAV maintains level flight.

CYCLE IRS OFF – NAV – with the airplane on the ground any IRS has detected a condition that requires cycling inertial power off and back to NAV.

DESCENT PATH DELETED – VNAV active and all waypoint altitude constraints defining the descent profile deleted.

**Note:** This message displays before execution of the modification which deletes the descent path.

DISCONTINUITY – LNAV active and the airplane has passed the last waypoint prior to a route discontinuity (except on a manually terminated leg, such as a VECTORS legs).

DRAG REQUIRED – VNAV active and additional drag required or autothrottle off and less thrust required to maintain the VNAV descent path.

END OF OFFSET – LNAV active and two minutes prior to end of active route offset. AFDS maintains last heading if active route offset overflow.

END OF ROUTE – LNAV active and end of active route overflow. AFDS maintains last heading.

ENTER IRS POSITION – the flight crew–entered present position did not pass one of the IRS comparison checks, or the IRS is ready to change to navigate mode and has not received a present position entry. Use the CLEAR key to remove this message.

FMC L (or R) OUTPUT LOSS – data output or discreet signals from indicated FMC are lost.

FUEL DISAGREE – PROG 2 – totalizer fuel quantity and FMC calculated fuel quantity disagree by a significant amount.

INSUFFICIENT FUEL – estimated fuel at destination less than entered RESERVES value.

IRS MOTION – an IRS has detected motion while in ALIGN.

IRS NAV ONLY – the FMC has been without radio or GPS updating for a predetermined time.

IRS POS/ORIGIN DISAGREE – valid inertial position differs from active origin airport.

LIMIT ALT FLXXX – the flight crew– or FMC–selected altitude is greater than the VNAV limit altitude.

NAV DATA OUT OF DATE – the clock calendar date is after the active navigation database valid calendar cycle.

NAV INVALID–TUNE XXXX – RNAV or VOR approach procedures must have a specific navaid tuned. It is either not tuned or a valid signal is not being received.

NO ACTIVE ROUTE – LNAV selected and no active route activated.

PERF/VNAV UNAVAILABLE – VNAV selected and gross weight, cost index, or cruise altitude are not entered.

RESET MCP ALT – 2 minutes prior to the top of descent point with VNAV active and MCP not set to altitude below cruise altitude.

RW/ILS CRS ERROR – LOC mode armed and the selected ILS course is incorrect for the active route runway.

RW/ILS FREQ ERROR – the selected ILS frequency does not match frequency for runway in active route.

SET CLOCK TO UTC TIME – the UTC time from the GPS disagrees with the captain's clock by more than 12 seconds.

SINGLE FMC L (or R) OPERATION – only the indicated FMC is operating.

SPLIT IRS OPERATION – a fault exists on an IRS making only two IRSs available for navigation.

TAKEOFF SPEEDS DELETED – selected V speeds have been deleted due to changes in takeoff performance or configuration data.

THRUST REQUIRED – VNAV active, autothrottle disconnected, and additional thrust required to track VNAV descent path and maintain speed.

UNABLE NEXT ALT – VNAV active and climb not sufficient to comply with waypoint altitude constraint.

VERIFY POSITION – the difference between the FMC position and other position data exceeds a comparison threshold. The possible conflicts are:

- the left FMC position differs from the right FMC position
- the radio position, with radio updating, differs from the FMC position
- the GPS position, with GPS updating, differs from the FMC position

VERIFY RNP – POS REF 2 – the default RNP has changed due to a change in flight phase and the flight crew entered RNP value exceeds the new default RNP value.

VIA OFFSET INVALID – flight conditions invalidate the modification with a divert to an alternate airport via OFFSET.

## **FMC Advisory Messages**

FMC advisory messages are displayed on the CDU scratchpad and illuminate the CDU message light (MSG). There are no EICAS messages associated with these messages and they do not cause the FMC light to illuminate.

Those messages which are caused by an entry error must be cleared before the entry can continue.

CRS REVERSAL AT FA FIX – a conflict exists between the default final approach (FA) waypoint (result of a runway or VFR approach selection) and the flight plan before it.

DELETE – DEL key pushed.

ENG OUT SID MOD – an engine failure is sensed after takeoff before the flaps are fully retracted; the FMC has automatically loaded an available engine out standard instrument departure as a route modification to the active route.



**HOLD AT XXXX** – a waypoint not contained in the active route is entered into the HOLD AT box on the RTE LEGS page, after selection of the HOLD function key. Selection of HOLD AT XXXX into a RTE LEGS page waypoint line makes a holding fix at the XXXX waypoint.

**INVALID DELETE** – deletion of selected data is not allowed.

**INVALID ENTRY** – entry format or range is incorrect for the selected field or the entered airway or TO waypoint does not coincide with the navigation database.

**INVALID TUNE REQUEST** – attempt to remotely tune a VOR is not valid.

**KEY/FUNCTION INOP** – selected mode key is inoperative.

**MANUALLY TUNED** – attempt to remotely tune a VOR that is manually tuned.

**MAX ALT FLXXX** – the altitude entry on any CDU page is above the performance calculated maximum altitude.

**NOT IN DATABASE** – data is not in the route or the navigation database.

**NOT ON INTERCEPT HEADING** – LNAV selected and the airplane is outside active capture criteria and the present heading will not intercept the active leg.

**ROUTE FULL** – the route is filled to the allowable capacity.

**RUNWAY N/A FOR SID** – selected runway not compatible with SID.

**STANDBY ONE** – the FMC temporarily prevents further CDU inputs.

**TIMEOUT–RESELECT** – communication between the FMC and the CDU has failed. The flight crew must reselect FMC on the CDU MENU page.

**UNABLE CRZ ALT** – performance predicts a zero cruise time at the entered cruise altitude.

**VERIFY RNP ENTRY** – the entered RNP value is greater than the default RNP value for the present flight phase or, less than the present Actual Navigation Performance.

**VOR AAA INVALID** – signal is lost from remotely tuned VOR (AAA is the identifier for the VOR).

**XXXXXX** – altitude set in the MCP window when VNAV is engaged, the CLB or CRZ page is displayed, and the altitude is above, within 4000 feet below, and not equal to the CRZ ALT.

---

## **CDU Annunciator Lights**

These annunciator lights illuminate when certain conditions exist.

**DSPY** – a flight plan modification is pending and the RTE, RTE LEGS, RTE DATA, or RTE HOLD page not containing the active leg or route segment is displayed, or a VNAV page (CLB, CRZ, or DES) not corresponding to the active VNAV mode is displayed.

FAIL – the associated FMC has failed.

OFST – an offset path has been entered and executed.

MSG – an FMC message is waiting to display or is displayed.

**Controls and Indicators . . . . . 12.10**

Fuel System . . . . . 12.10.1

Fuel Indications . . . . . 12.10.2

    Fuel Quantity Indicator . . . . . 12.10.2

Fuel Quantity Test . . . . . 12.10.3

**System Description . . . . . 12.20**

Introduction . . . . . 12.20.1

Fuel Quantity . . . . . 12.20.1

Fuel Temperature . . . . . 12.20.1

Fuel Pumps . . . . . 12.20.1

Fuel Crossfeed . . . . . 12.20.2

Suction Feed . . . . . 12.20.3

Fuel Configuration Light . . . . . 12.20.3

Fuel Imbalance . . . . . 12.20.3

Fuel Tank Locations and Capacities . . . . . 12.20.4

    Fuel Tank Locations . . . . . 12.20.4

    Fuel Tank Capacities . . . . . 12.20.4

Fuel System Schematic . . . . . 12.20.5

APU Fuel Feed . . . . . 12.20.5

Fuel System FMS CDU Messages . . . . . 12.20.6

**EICAS Messages . . . . . 12.30**

Fuel System EICAS Messages . . . . . 12.30.1

Intentionally  
Blank

#### Fuel System

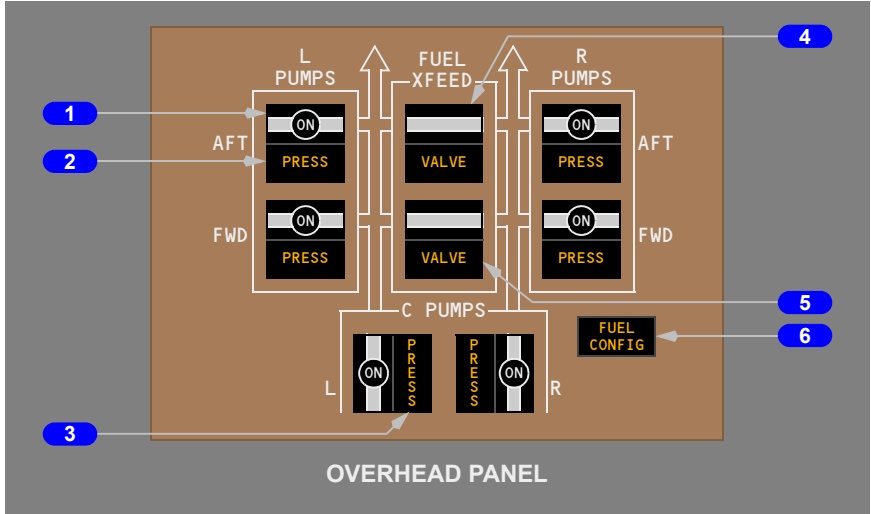

#### 1 Left/Center/Right (L/C/R PUMPS) Switches

ON – the fuel pump is selected ON

Off (ON not visible) – the fuel pump is selected off

#### 2 Left/Right Pump Pressure (PRESS) Lights

Illuminated (amber) – fuel pump output pressure is low

#### 3 Center Pump Pressure (PRESS) Lights

Illuminated (amber) –

- fuel pump output pressure is low with the pump selected ON
- associated N3 below 50% with pump switch ON
- associated N2 below 50% with pump switch ON

#### 4 Fuel Crossfeed (FUEL XFEED) Switches

On (bar visible) – the crossfeed valve is selected open

Off (bar not visible) – the crossfeed valve is selected closed

**5 Crossfeed VALVE Light**

Illuminated (amber) – the crossfeed valve is not in the selected position

**6 Fuel Configuration (FUEL CONFIG) Light**

Illuminated (amber) –

- low fuel quantity
- imbalance between left and right main tanks
- center tank fuel pumps off with fuel in center tanks

---

## Fuel Indications

### Fuel Quantity Indicator

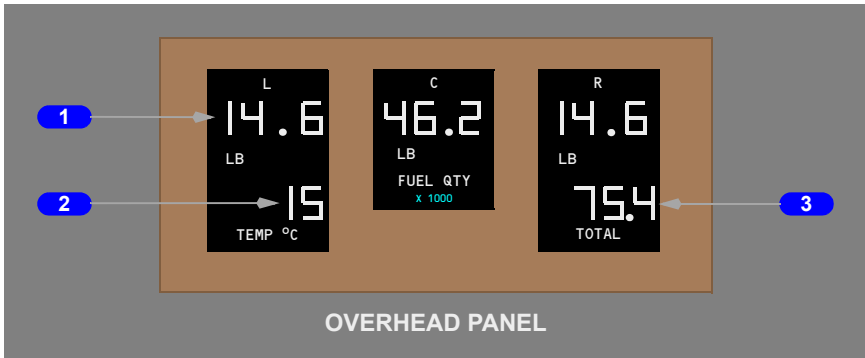

**1 Fuel Quantity (L/C/R FUEL QTY) Indication**

Displays usable fuel quantity in the left main, center, and right main tank (pounds x 1000)

**2 Fuel Temperature (TEMP) Indication**

Displays temperature of fuel in the right main tank (degrees celsius)

**3 TOTAL Fuel Quantity Indication**

Displays total usable fuel quantity in all tanks (pounds x 1000)

## Fuel Quantity Test

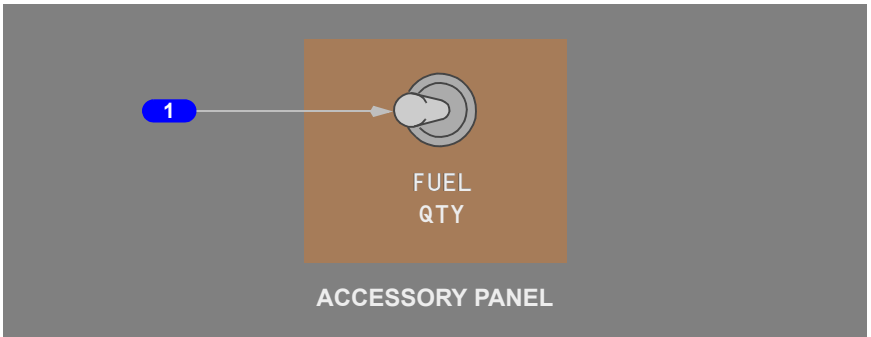

- 1 Fuel Quantity (FUEL QTY) Test Switch –**  
Spring-loaded to center  
Initiates fuel quantity test

Intentionally  
Blank



---

**Introduction**

The fuel system supplies fuel to the engines and the APU. The fuel is contained in a center tank, and left and right main tanks.

Refer to Chapter 7, Engines, APU, for an additional description of the engine and APU fuel systems.

---

**Fuel Quantity**

Fuel quantity data, measured by probes in each tank, is fed to the fuel quantity processor where it is corrected for density then displayed on a fuel quantity indicator for each tank. Total fuel quantity, from a separate calculation, is shown on the total fuel quantity indicator and is also provided to the FMC.

When total usable fuel in either the left or right main tank drops below approximately 2200 pounds, the FUEL CONFIG light illuminates and the LOW FUEL caution message is displayed.

---

**Fuel Temperature**

Temperature of the fuel in the right main tank is displayed on the fuel temperature indicator.

---

**Fuel Pumps**

Each fuel tank contains two AC-powered fuel pumps. A single pump can supply sufficient fuel to operate one engine under all conditions.

The two center tank fuel pumps have greater output pressure than the left and right main tank fuel pumps. When all six pumps are operating, the center tank pumps override the left and right main tank pumps so that center tank fuel is used before left or right main tank fuel.

If any pump has low output pressure, the appropriate switch PRESS light illuminates and the pump pressure EICAS message is displayed. If the left or right main tank pump switches are OFF, the low pressure lights are illuminated and EICAS messages for the pumps are displayed. When the center pump switches are OFF, the low pressure lights and EICAS messages for the center pumps are inhibited.

To reduce electrical loads, the center tank pumps are inhibited when the associated N3 is less than 50% RPM. Thus both center tank pumps are inhibited when the engines are shutdown. As an engine is started and N3 RPM increases above 50%, the inhibit is removed for the associated center tank pump.

To reduce electrical loads, the center tank pumps are inhibited when the associated N2 is less than 50% RPM. Thus both center tank pumps are inhibited when the engines are shutdown. As an engine is started and N2 RPM increases above 50%, the inhibit is removed for the associated center tank pump.

The EICAS caution messages, L or R FUEL SYS PRESS, displays when all fuel pumps have low output pressure or all fuel pumps on one side have low output pressure and the crossfeed switches are off.

The fuel pump low pressure messages are inhibited by the corresponding L or R FUEL SYS PRESS messages.

During normal operation, the EICAS advisory messages CTR L FUEL PUMP and CTR R FUEL PUMP display to indicate depletion of center tank fuel.

With either messages displayed, a small amount of center tank fuel maybe indicated. A scavenge system will operate automatically to transfer any remaining center tank fuel to the left main tank. Fuel scavenge begins when the left main tank is approximately half empty.

The left main tank contains a DC-powered fuel pump. It has no controls or indicators. The DC pump operates automatically to provide fuel to the APU when AC power is not available and the APU selector is ON.

---

## Fuel Crossfeed

The fuel manifolds are arranged so that any fuel tank pump can supply either engine. Two crossfeed valves isolate the left fuel manifold from the right. These valves are normally closed providing fuel feed from tank to engine. Both valves are opened any time it becomes necessary to feed an engine from an opposite fuel tank. Only one open crossfeed valve is required for successful crossfeed operation. A VALVE disagreement light illuminates and the EICAS advisory message FWD FUEL X-FEED or AFT FUEL X-FEED displays if a valve position does not agree with its switch position. The L or R FUEL SYS PRESS messages are inhibited with either crossfeed valve open.

---

## Suction Feed

When main tank fuel pump pressure is low, each engine can draw fuel from its corresponding main tank through a suction feed line that bypasses the pumps. As the airplane climbs, dissolved air is released from the fuel in the tank due to the decrease in air pressure. This air may collect in the suction feed line and restrict fuel flow. At high altitude, thrust deterioration or engine flameout may occur as a result of the fuel flow reduction.

Fuel pressure can be provided from a main tank with operating fuel pumps to both engines by opening the fuel crossfeed valves. Continued crossfeed use will result in a progressive fuel imbalance.

The dissolved air in the fuel tank will eventually deplete after reaching cruise altitude. The depletion time is dependent upon airplane altitude, fuel temperature, and type of fuel. Once the dissolved air is depleted, the engine may be capable of suction feed operation at cruise power.

---

## Fuel Configuration Light

When the fuel quantity in left and right main tanks differ by 1800 pounds or center fuel pump switches are OFF with more than 1200 pounds in the center tank, the FUEL CONFIG light illuminates and the EICAS advisory message FUEL CONFIG is displayed.

The FUEL CONFIG light also illuminates when the LOW FUEL EICAS message is displayed.

---

## Fuel Imbalance

Fuel balancing is accomplished by opening the crossfeed valves and turning off the fuel pump switches for the left or right main fuel tank that has the lowest quantity. Fuel balancing may be done in any phase of flight.

---

---

## Fuel Tank Locations and Capacities

### Fuel Tank Locations

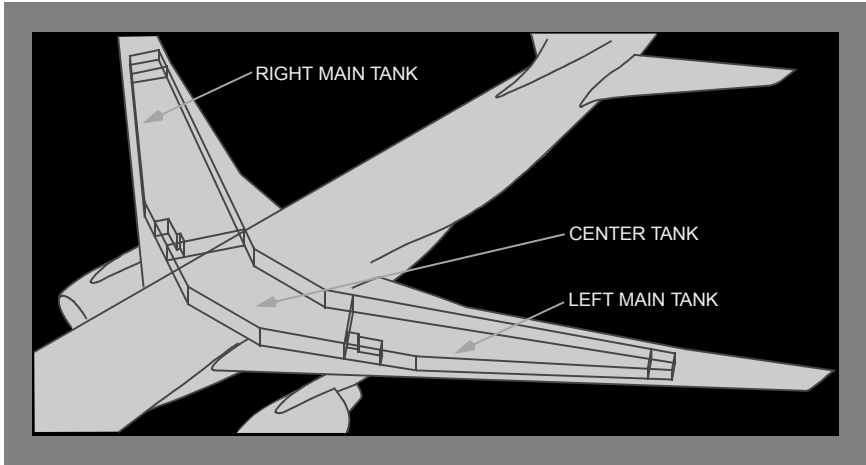

### Fuel Tank Capacities

Tank	U.S. Gallons	Pounds *
Left main	2,176	14,579
Right main	2,176	14,579
Center	6,924	46,391
Total	11,276	75,549

\* Usable fuel at level attitude, fuel density = 6.7 LB/U.S. Gallon

## Fuel System Schematic

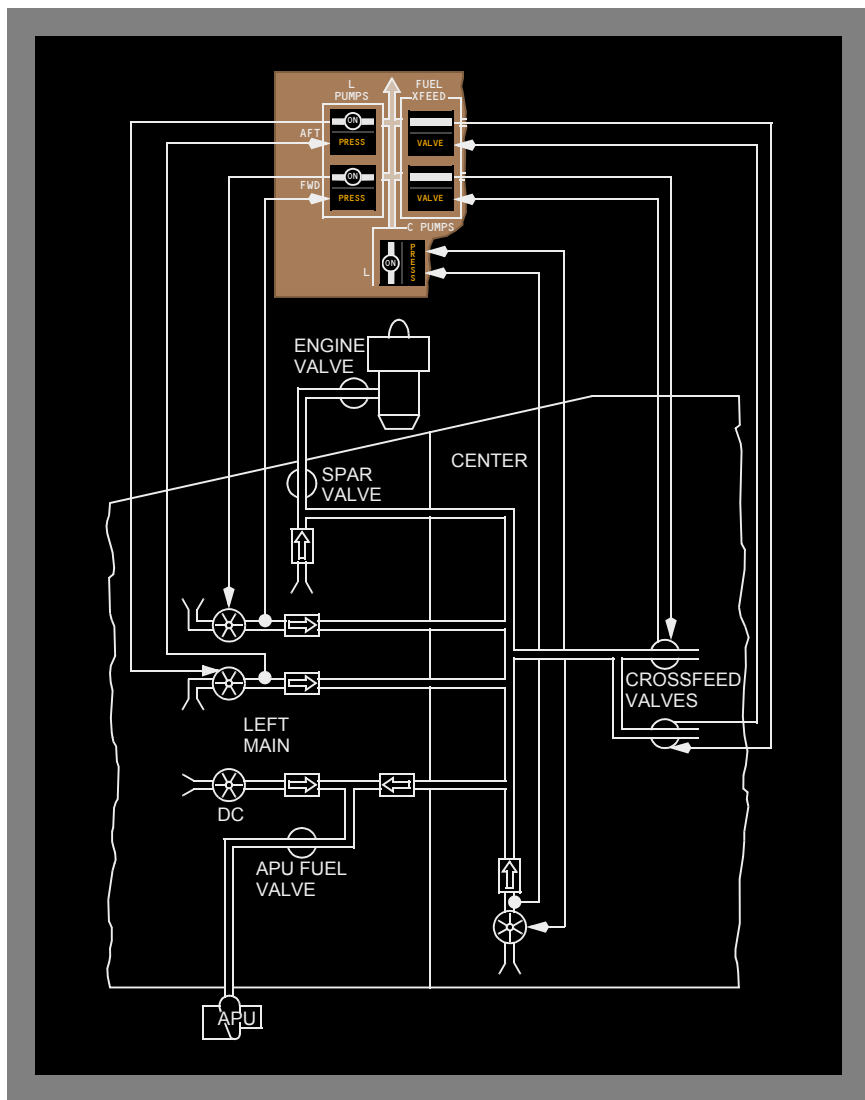

### APU Fuel Feed

APU fuel is supplied from the left fuel manifold. APU fuel can be provided by any AC fuel pump supplying fuel to the left fuel manifold or by the left main tank DC fuel pump.

On the ground, with the APU selector ON and no AC power available, the DC pump runs automatically. With AC power available, the left forward AC fuel pump operates automatically, regardless of fuel pump switch position, and the DC fuel pump turns off. In flight, the left forward AC fuel pump can be turned off with the fuel pump switch.

---

### **Fuel System FMS CDU Messages**

The CDU can display the following messages:

INSUFFICIENT FUEL – Predicted fuel at destination is less than the FMC reserves

FUEL DISAGREE–PROG 2 – The fuel totalizer and calculated fuel quantity disagree

**Fuel System EICAS Messages**

The following EICAS messages can be displayed.

<b>Message</b>	<b>Level</b>	<b>Light</b>	<b>Aural</b>	<b>Condition</b>
FUEL CONFIG	Advisory	FUEL CONFIG		Both center pump switches are OFF with fuel in the center tank, or a fuel imbalance between left and right main tanks
AFT FUEL X-FEED FWD FUEL X-FEED	Advisory	VALVE		The crossfeed valve position disagrees with the commanded position
CTR L FUEL PUMP CTR R FUEL PUMP L AFT FUEL PUMP R AFT FUEL PUMP L FWD FUEL PUMP R FWD FUEL PUMP	Advisory	PRESS		Fuel pump output pressure is low
L FUEL SYS PRESS R FUEL SYS PRESS	Caution		Beeper	All fuel pumps have low output pressure or all fuel pumps on one side have low output pressure and the crossfeed switches are off
LOW FUEL	Caution	FUEL CONFIG	Beeper	Fuel quantity is low in either left or right main tank

Intentionally  
Blank



**Controls and Indicators . . . . . 13.10**

- Hydraulic Panel . . . . . 13.10.1
  - Status Display . . . . . 13.10.2
- Miscellaneous Hydraulic System Controls . . . . . 13.10.3
  - Power Transfer Unit . . . . . 13.10.3
  - Ram Air Turbine . . . . . 13.10.3

**System Description . . . . . 13.20**

- Introduction . . . . . 13.20.1
  - Hydraulic Systems Schematic . . . . . 13.20.2
- Left Hydraulic System . . . . . 13.20.3
  - Fluid Supply . . . . . 13.20.3
  - Engine-driven Pump . . . . . 13.20.3
  - Electric Motor-driven Pumps . . . . . 13.20.3
  - Power Transfer Unit (PTU) . . . . . 13.20.4
  - System Pressure Indications . . . . . 13.20.4
- Right Hydraulic System . . . . . 13.20.4
  - Fluid Supply . . . . . 13.20.4
  - Engine-driven Pump . . . . . 13.20.4
  - Electric Motor-driven Pump . . . . . 13.20.5
  - System Pressure Indications . . . . . 13.20.5
  - Reserve Brakes System . . . . . 13.20.5
- Center Hydraulic System . . . . . 13.20.5
  - Fluid Supply . . . . . 13.20.5
  - Electric Motor-driven Pump . . . . . 13.20.5
  - System Pressure Indications . . . . . 13.20.5
- Ram Air Turbine (RAT) Pump . . . . . 13.20.6

**EICAS Messages . . . . . 13.30**

- Hydraulics EICAS Messages . . . . . 13.30.1

Intentionally  
Blank

#### Hydraulic Panel

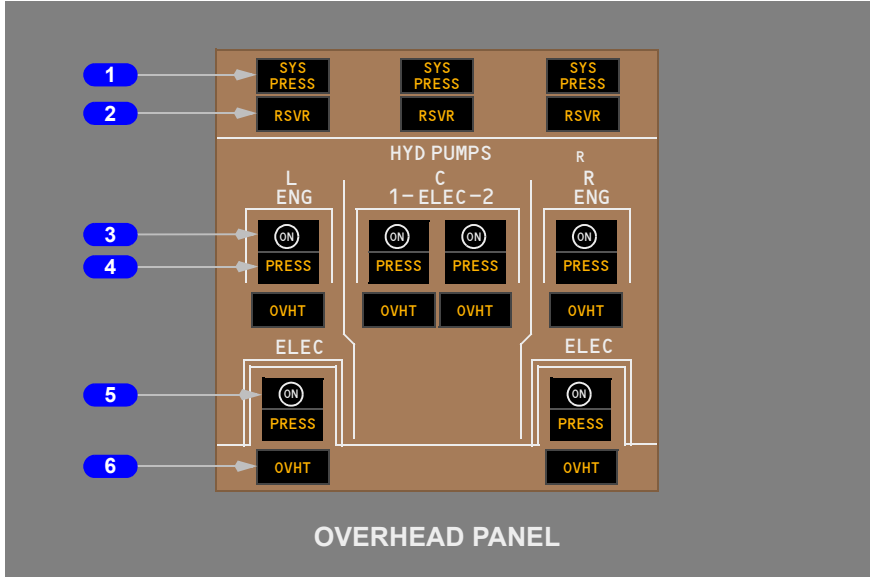

#### **1** System Pressure (SYS PRESS) Lights

Illuminated (amber) – system pressure is low.

#### **2** Reservoir Low Quantity (RSVR) Lights

Illuminated (amber) –reservoir quantity is low, or reservoir pressure is low.

#### **3** Left/Right Engine (L/R ENG) Pump Switches

ON – the engine–driven hydraulic pump pressurizes when engine rotates.

Off (ON not visible) – the engine–driven hydraulic pump is turned off and depressurized.

#### **4** Pump Pressure (PRESS) Lights

Illuminated (amber) – pump output pressure is low.

**5 Left/Right and Center 1/2 Electric (L/R ELEC and C1/2 ELEC) Pump Switches**

ON – the electric motor–driven pump pressurizes the left, center or right hydraulic system.

Off (ON not visible) – the electric motor–driven hydraulic pump is turned off and depressurized.

**6 Pump Overheat (OVHT) Lights**

Illuminated (amber) – pump temperature is high.

**Status Display**

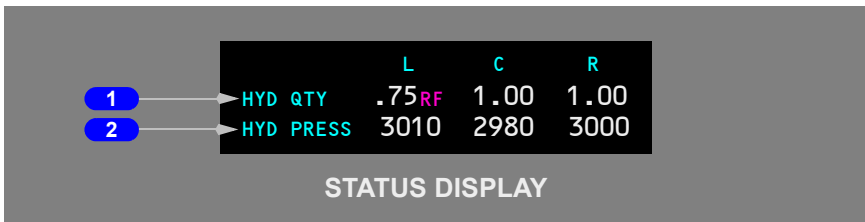

**1 Hydraulic Fluid Quantities (HYD QTY)**

- displays system reservoir quantity (1.00 is the normal service level)
- RF (magenta) – displayed when the reservoir requires refilling

**2 Hydraulic System Pressures (HYD PRESS)**

Displays hydraulic pressure in pounds per square inch of the pump with the highest pressure.

## Miscellaneous Hydraulic System Controls

### Power Transfer Unit

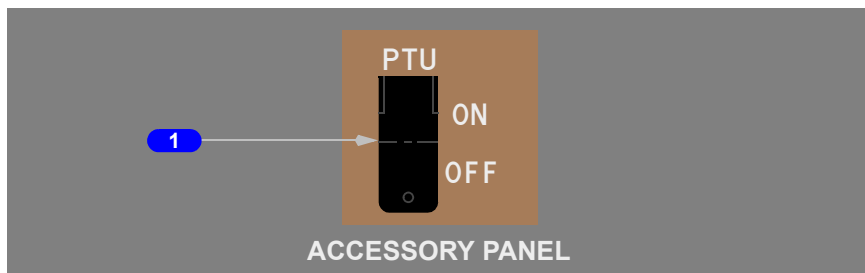

#### 1 Power Transfer Unit (PTU) Switch

ON – PTU operates if right engine operating.

OFF – PTU operates only when automatically activated.

### Ram Air Turbine

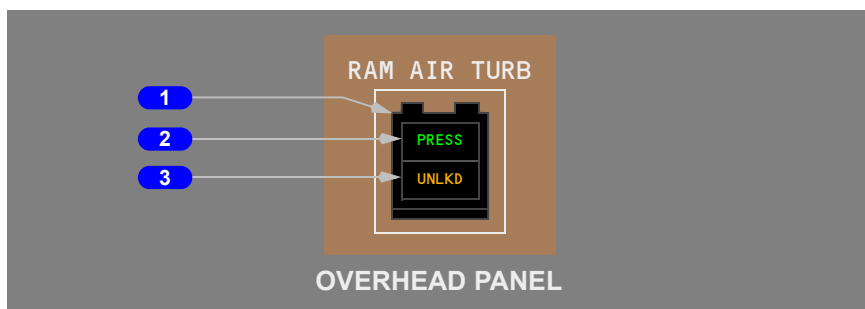

#### 1 RAM AIR Turbine (TURB) Switch

Push – deploys the RAT.

#### 2 Ram Air Turbine Pressure (PRESS) Light

Illuminated (green) –

- the RAT is deployed
- the RAT is producing hydraulic pressure

#### 3 Ram Air Turbine Unlocked (UNLKD) Light

Illuminated (amber) – the RAT is not stowed and locked.

Intentionally  
Blank

**Introduction**

The airplane has three independent hydraulic systems: left, right, and center. The hydraulic systems power the:

- flight controls
- leading edge slats
- trailing edge flaps
- landing gear
- wheel brakes
- nose wheel steering
- thrust reversers
- autopilot servos

Flight control system components are distributed so that any one hydraulic system can provide adequate airplane controllability.

Hydraulic fluid is supplied to each hydraulic pump from the associated system reservoir. The reservoirs are pressurized by the bleed air system.

### Hydraulic Systems Schematic

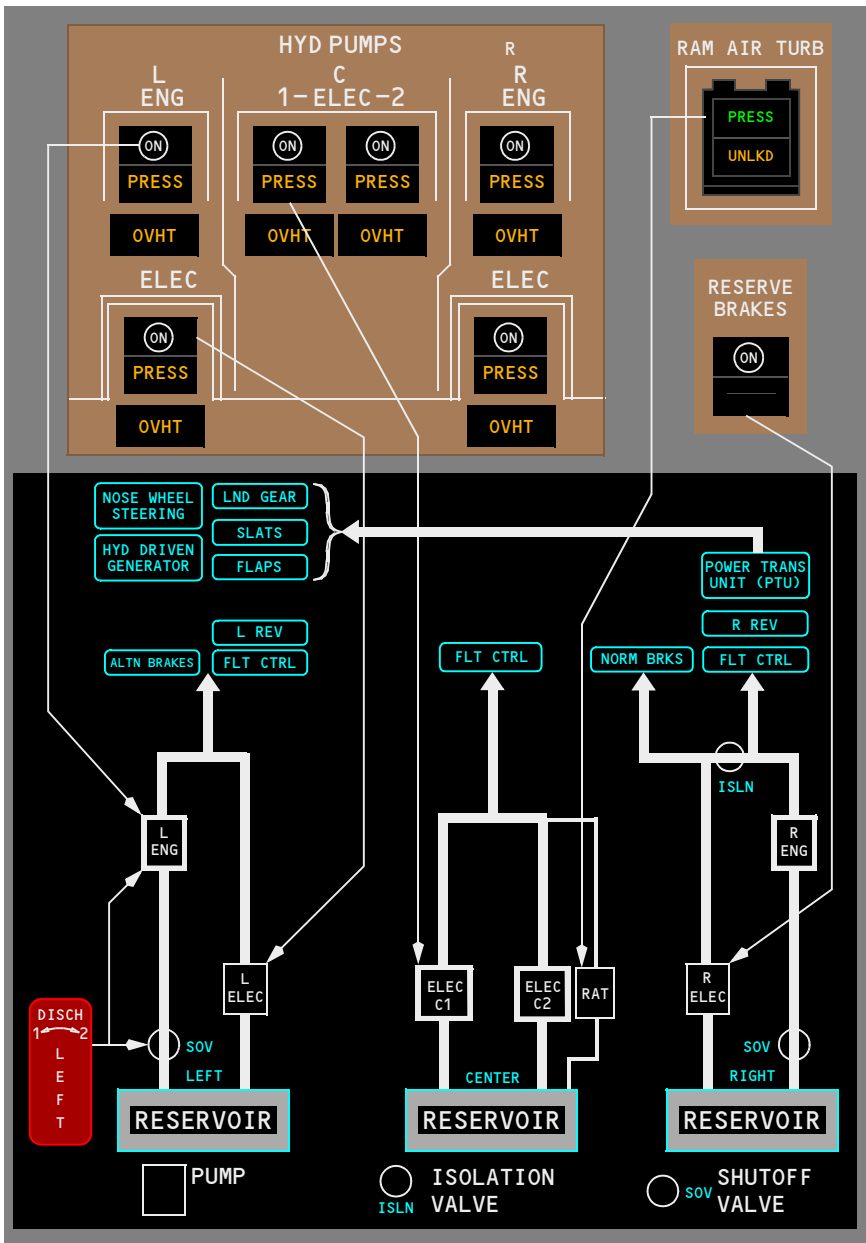



---

---

## Left Hydraulic System

The left hydraulic system powers:

- flight controls
- flaps and slats
- landing gear
- alternate brakes
- nose wheel steering
- left engine thrust reverser
- hydraulic driven generator

The system consists of a reservoir, engine-driven pump, electric motor-driven pump, and a power transfer unit (PTU) pump.

### Fluid Supply

Hydraulic fluid is supplied to each hydraulic pump from a reservoir. The reservoir is pressurized by the bleed air system. A quantity measuring system provides information to the EICAS status display. RF displays when a reservoir requires refilling prior to dispatch. The RSVR light illuminates and the EICAS advisory message L HYD QTY displays when the reservoir quantity is low. The RSVR light also illuminates and the EICAS advisory message L HYD RSVR PRESS displays when the reservoir air pressure is low.

The reservoir maintains reserve hydraulic fluid for use by the PTU in the event of a left system hydraulic leak.

Fluid for the engine-driven pump flows through a shutoff valve controlled by the engine fire switch. Pulling the fire switch shuts off the flow of fluid to the engine pump and depressurizes the pump.

### Engine-driven Pump

The primary hydraulic system pump is an engine-driven pump.

The pump PRESS light illuminates and the EICAS advisory message L HYD ENG PUMP displays when the pump output pressure is low. The pump OVHT light illuminates and the EICAS advisory message L ENG HYD OVHT displays when the pump temperature is high.

### Electric Motor-driven Pumps

An electric motor-driven pump provides additional hydraulic power.

The pump PRESS light illuminates and the EICAS advisory message L HYD ELEC PUMP displays when the pump output pressure is low. The pump OVHT light illuminates and the EICAS advisory message L ELEC HYD OVHT displays when the pump temperature is high.

## **Power Transfer Unit (PTU)**

The PTU is a hydraulic motor pump which transfers hydraulic power from the right system to the left system. The PTU is automatically activated if the left engine fails or the left engine-driven pump pressure is low. When activated, the PTU supplements the left hydraulic system electric motor-driven pump to operate the following:

- flaps and slats
- landing gear
- nose wheel steering
- hydraulic driven generator

PTU operation is inhibited if the right engine is not operating.

## **System Pressure Indications**

The SYS PRESS light illuminates and the EICAS caution message L HYD SYS PRESS displays when the hydraulic system pressure is low.

Hydraulic system pressure displays on the EICAS status page. When the engine-driven and electric motor-driven pumps are inoperative, the EICAS status page displays the PTU output pressure.

---

## **Right Hydraulic System**

The right hydraulic system is similar to the left system. The right system powers:

- flight controls
- normal brakes
- reserve brakes
- right engine thrust reverser
- power transfer unit (PTU)

The system consists of a reservoir, engine-driven pump, and an electric motor-driven pump.

## **Fluid Supply**

The right reservoir is similar to the left system. The associated EICAS messages for low reservoir quantity or low reservoir air pressure are R HYD QTY and R HYD RSVR PRESS.

The reservoir maintains a reserve hydraulic fluid for use by the reserve brakes in the event of a right system hydraulic leak.

## **Engine-driven Pump**

The right engine-driven pump is identical to the left system. The associated EICAS messages for low pump output pressure or high pump temperature are R HYD ENG PUMP and R ENG HYD OVHT.

---

## Electric Motor–driven Pump

The right electric motor–driven pump is identical to the left system. The associated EICAS messages for low pump output pressure or high pump temperature are R HYD ELEC PUMP and R ELEC HYD OVHT.

## System Pressure Indications

The right system pressure indications are similar to the left system. The associated message for low system pressure is R HYD SYS PRESS.

## Reserve Brakes System

Pushing the RESERVE BRAKES switch configures the hydraulic system to use the reservoir’s reserve fluid, activates the electric motor–driven pump regardless of the pump switch position and isolates the pump output power to only the normal brakes.

---

## Center Hydraulic System

The center system powers only flight controls.

The system consists of a reservoir, two electric motor–driven pumps, and a ram air turbine (RAT) pump.

## Fluid Supply

The center reservoir is similar to the left system. The associated EICAS messages for low reservoir quantity or low reservoir air pressure are C HYD QTY and C HYD RSVR PRESS.

The reservoir maintains reserve hydraulic fluid for use by the ram air turbine in the event of a center system hydraulic leak.

## Electric Motor–driven Pump

The two center electric motor–driven pumps are similar to the left system pump. The C2 pump may be load shed automatically to reduce electrical loads. The associated EICAS messages for low pump output pressure or high pump temperature are C HYD ELEC 1, C HYD ELEC 2, C HYD 1 OVHT, and C HYD 2 OVHT.

## System Pressure Indications

The center system pressure indications are similar to the left system. The associated message for low system pressure is C HYD SYS PRESS.

## **Ram Air Turbine (RAT) Pump**

The RAT, when deployed provides hydraulic power to the flight controls portion of the center hydraulic system. The RAT provides adequate hydraulic power at speeds above 130 knots. In flight, the RAT deploys automatically when both engines fail.

The RAT can be deployed manually by pushing the RAM AIR TURB switch. The UNLKD light illuminates and the EICAS advisory message RAT UNLOCKED displays when the RAT is not stowed and locked. When the RAT is producing pressure the ram air turbine PRESS light illuminates. Once deployed, the RAT cannot be stowed in flight.

**Hydraulics EICAS Messages**

The following EICAS messages can be displayed.

<b>Message</b>	<b>Level</b>	<b>Light</b>	<b>Aural</b>	<b>Condition</b>
L ELEC HYD OVHT R ELEC HYD OVHT L ENG HYD OVHT R ENG HYD OVHT C HYD 1 OVHT C HYD 2 OVHT	Advisory	OVHT		Pump temperature is high.
L HYD ELEC PUMP R HYD ELEC PUMP L HYD ENG PUMP R HYD ENG PUMP C HYD ELEC 1 C HYD ELEC 2	Advisory	PRESS		Pump output pressure is low.
C HYD QTY L HYD QTY R HYD QTY	Advisory	RSVR		Hydraulic quantity is low.
C HYD RSVR PRESS L HYD RSVR PRESS R HYD RSVR PRESS	Advisory	RSVR		Reservoir air pressure is low.
C HYD SYS PRESS L HYD SYS PRESS R HYD SYS PRESS	Caution	SYS PRESS	Beeper	Hydraulic system pressure is low.
RAT UNLOCKED	Advisory	UNLKD		The ram air turbine is not stowed and locked.

Intentionally  
Blank

**Controls and Indicators . . . . . 14.10**

- Landing Gear Panel . . . . . 14.10.1
  - Gear Indications . . . . . 14.10.1
  - Gear Extension/Retraction . . . . . 14.10.2
- Nose Wheel Steering Tiller . . . . . 14.10.3
- Brake System . . . . . 14.10.3
  - Rudder/Brake Pedals . . . . . 14.10.3
  - Auto Brakes Selector . . . . . 14.10.4
  - Parking Brake Handle . . . . . 14.10.4
  - Brake Accumulator Pressure Indicator . . . . . 14.10.5
  - Brake Source Light . . . . . 14.10.5
  - Reserve Brakes . . . . . 14.10.5
- Antiskid Light . . . . . 14.10.6
- Brake Temperature . . . . . 14.10.6

**System Description . . . . . 14.20**

- Introduction . . . . . 14.20.1
- Air/Ground Sensing System . . . . . 14.20.1
- Landing Gear Operation . . . . . 14.20.1
  - Landing Gear Retraction . . . . . 14.20.2
  - Landing Gear Extension . . . . . 14.20.2
  - Landing Gear Alternate Extension . . . . . 14.20.2
- Nose Wheel Steering . . . . . 14.20.3
- Brake System . . . . . 14.20.3
  - Normal Brake Hydraulic System . . . . . 14.20.3
  - Alternate Brake Hydraulic System . . . . . 14.20.3
  - Reserve Brakes . . . . . 14.20.4
  - Brake Accumulator . . . . . 14.20.4
  - Antiskid Protection . . . . . 14.20.4
  - Autobrake System . . . . . 14.20.4
  - Parking Brake . . . . . 14.20.5

---

Brake Temperature Indication. . . . .	14.20.6
<b>EICAS Messages . . . . .</b>	<b>14.30</b>
Landing Gear EICAS Messages. . . . .	14.30.1



## Landing Gear Panel

### Gear Indications

[Option-Gear panel without Brake Temp light]

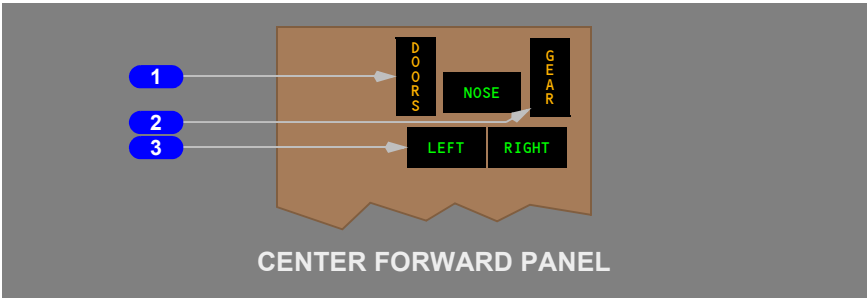

[Option-Gear panel with Brake Temp light]

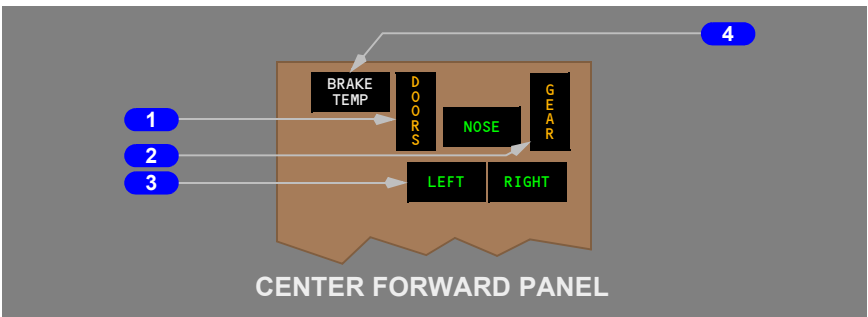

#### **1 DOORS Light**

Illuminated (amber) – a door is not closed.

#### **2 Landing GEAR Disagree Light**

Illuminated (amber) – the gear position disagrees with the lever position.

#### **3 Landing Gear Down Lights (NOSE, LEFT, and RIGHT)**

Illuminated (green) – the associated landing gear is down and locked.

**4 Brake Temperature (BRAKE TEMP) Light**

**[Option-Gear panel with Brake Temp light]**

Illuminated (white) – a wheel brake temperature is in high range (a value of 5 or above on the status page).

**Gear Extension/Retraction**

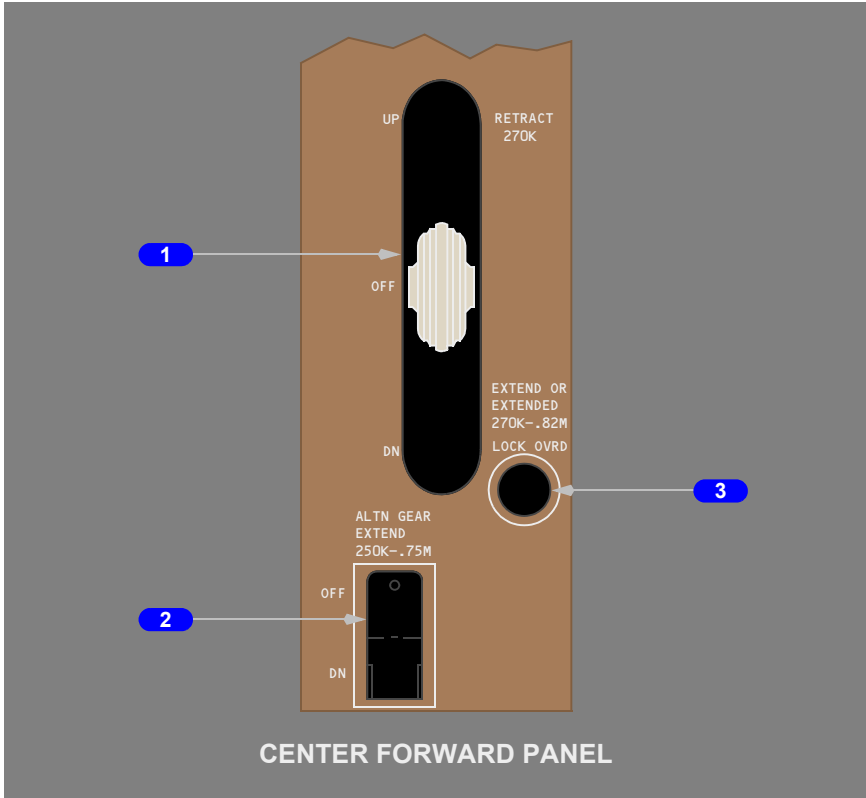

**1 Landing Gear Lever**

UP – the landing gear retracts.

OFF – hydraulic pressure is removed from landing gear system.

DN – the landing gear extends.

**2 Alternate Gear Extend (ALTN GEAR EXTEND) Switch**

OFF – the landing gear lever operates normally.

DN (down) – the landing gear extends by the alternate extension system.

---

**3 Landing Gear Lever Lock Override (LOCK OVRD) Switch**

Push – releases the landing gear lever lock.

---

## Nose Wheel Steering Tiller

A nose wheel steering tiller is installed on the left sidewall.

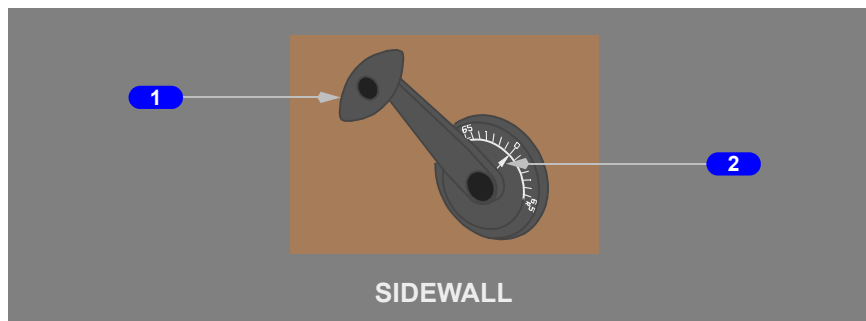

**1 Nose Wheel Steering Tiller**

Rotate –

- turns the nose wheels up to 65 degrees in either direction
- overrides rudder pedal steering

**2 Tiller Position Indicator**

Shows tiller displacement from the straight-ahead, neutral position.

---

## Brake System

### Rudder/Brake Pedals

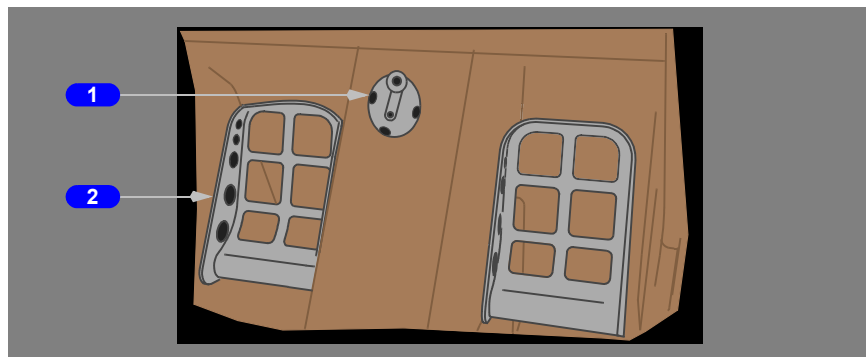

**1 Rudder Pedal Adjust Crank**

Pull and Rotate – adjusts the rudder pedals forward or aft.

**2 Rudder/Brake Pedals**

Push the full pedal – turns the nose wheel up to seven degrees in either direction.

Push the top of the pedals – actuates the wheel brakes.

Refer to Chapter 9, Flight Controls for the description of rudder operation.

**Auto Brakes Selector**

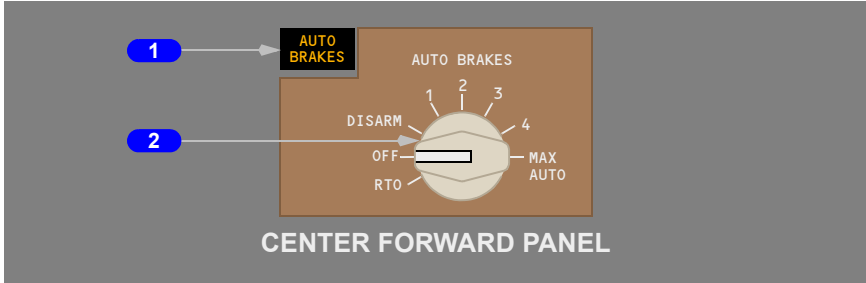

**1 AUTO BRAKES Light**

Illuminated (amber) – the autobrake is disarmed or inoperative.

**2 AUTO BRAKES Selector**

OFF – deactivates the autobrake system.

DISARM –

- disengages the autobrake system
- releases brake pressure

1,2,3,4, MAX AUTO – selects the desired deceleration rate.

RTO – automatically applies maximum brake pressure when the thrust levers are retarded to idle above 85 knots.

**Parking Brake Handle**

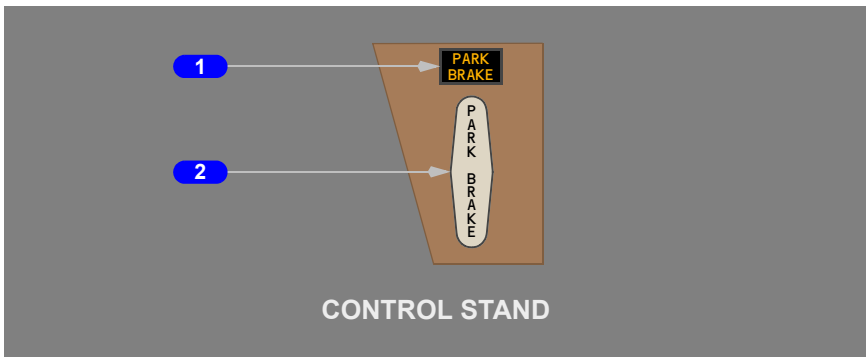

**1 Parking Brake (PARK BRAKE) Light**

Illuminated (amber) – the parking brake is set.

**2 Parking Brake (PARK BRAKE) Handle**

Pull – sets the parking brake when both brake pedals are simultaneously depressed.

Release – simultaneously depress both brake pedals.

**Brake Accumulator Pressure Indicator**

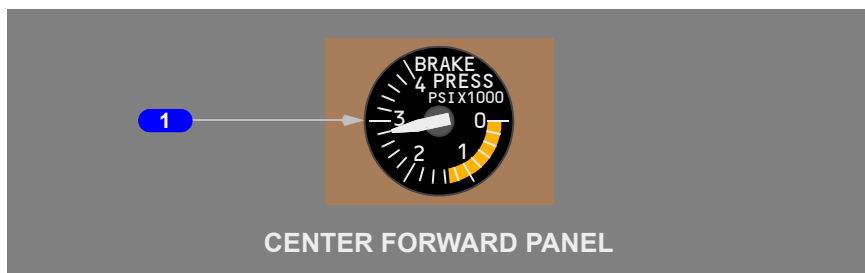

**1 Brake Accumulator Pressure (BRAKE PRESS) Indicator**

Indicates brake accumulator pressure (psi x 1000).

**Brake Source Light**

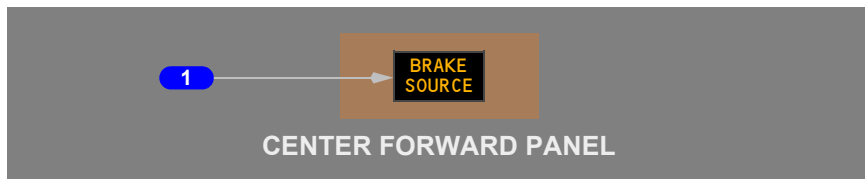

**1 BRAKE SOURCE Light**

Illuminated (amber) – both normal and alternate brake system pressures are low.

**Reserve Brakes**

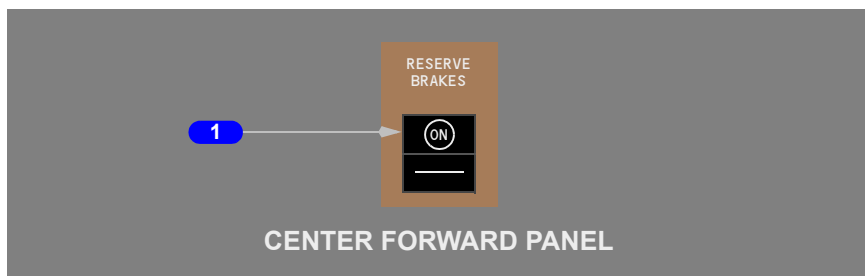

---

**1 RESERVE BRAKES Switch**

ON –

- allows use of reserve hydraulic fluid
- activates right electric hydraulic pump
- isolates the right electric hydraulic pump power to the normal brake system

OFF (ON not visible) –

- allows the right electric hydraulic pump switch to control the pump
- does not allow use of the reserve hydraulic fluid
- removes isolation of the right electric hydraulic pump power to only the normal brakes

---

**Antiskid Light**

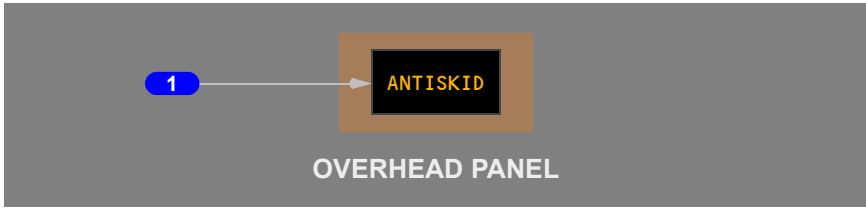

**1 ANTISKID Light**

Illuminated (amber) – a fault is detected in the antiskid system.

---

**Brake Temperature**

[Option-EICAS Display Brake Temp]

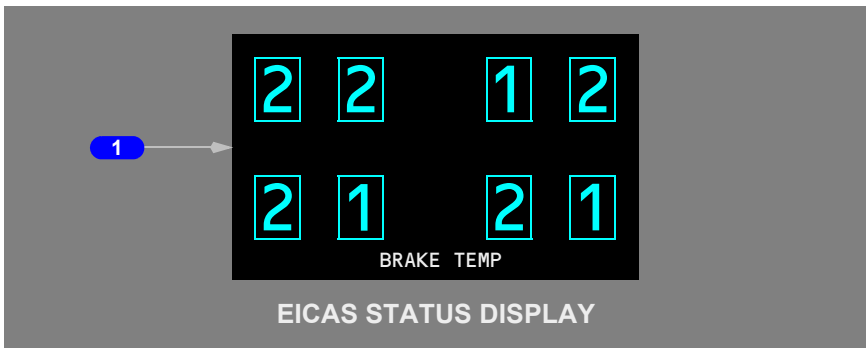

---

**1 Brake Temperature (BRAKE TEMP)**

Indicates a relative value of wheel brake temperature.

- values range from 0 to 9
- 0 to 2 – initial range, box and number are cyan
- 3 and 4 – normal range, box is white for the first brake per truck that exceeds the value of two and number cyan
- 5 to 9 – high range, box and number are white for each brake with a value of 5 or above

Intentionally  
Blank



---

**Introduction**

The airplane has two main landing gear and a single nose gear. The nose gear is a conventional steerable two-wheel unit. Each main gear has four wheels in tandem pairs.

Hydraulic power for retraction, extension, and steering is supplied by the left hydraulic system. An alternate extension system is also provided.

The normal/reserve brake hydraulic system is powered by the right hydraulic system. The alternate brake hydraulic system is powered by the left hydraulic system. Antiskid protection is provided with both systems, but the autobrake system is available only through the normal system.

**[Option - with Brake Temp EICAS display]**

A brake temperature monitor system displays each brake temperature on the EICAS status display.

---

**Air/Ground Sensing System**

In-flight and ground operation of various airplane systems are controlled by the air/ground sensing system and the nose air/ground sensing system.

The air/ground sensing system receives air/ground logic signals from tilt sensors located on each main landing gear. These signals are used to configure the airplane systems to the appropriate air or ground status.

A nose air/ground sensing system receives air/ground logic signals from nose gear strut compression sensors. These signals are for controlling stall warning and portions of the caution and warning system.

An EICAS advisory message AIR/GND SYS or NOSE A/G SYS indicates that some portion of the sensing system failed. Affected equipment and systems will not operate normally and therefore takeoff is not allowed.

---

**Landing Gear Operation**

The landing gear are normally controlled by the landing gear lever. On the ground, the lever is prevented from moving to the UP position by an automatic lever lock controlled by the main gear tilt sensors. When the gear is not tilted (aircraft on the ground) the lock is engaged. The lever lock can be manually overridden by pushing and holding the landing gear lever LOCK OVRD switch. In flight, the lever lock is automatically released through air/ground sensing of main gear tilt sensor.

---

## Landing Gear Retraction

After takeoff both main gear tilt, releasing the lever lock. When the landing gear lever is positioned to UP, the landing gear begins to retract. The gear down green lights extinguish, the GEAR and DOORS lights illuminate showing gear is in transit (gear, doors and lever position disagree). The landing gear doors open and the tilted main gear and nose gear move to the retract position. Automatic wheel braking occurs during gear retraction. After retraction, all three landing gear and their doors are held up by uplocks. The GEAR and DOORS lights extinguish. The landing gear lever is placed in the OFF position to depressurize the landing gear system.

The GEAR light remains illuminated and the EICAS caution message GEAR DISAGREE display if any gear is not up and locked up after the normal transit time. The affected gear's, gear down light, remains illuminated if the gear never unlocked from the down position. The DOORS light remains illuminated and the EICAS advisory message GEAR DOORS display if any hydraulically actuated door is not closed after normal transit time.

## Landing Gear Extension

When the landing gear lever is moved to DN, the landing gear doors open, the gear are unlocked, and the GEAR and DOORS lights illuminate.

The gear are hydraulically powered to the down and locked position. The downlocks are powered to the locked position, all hydraulically actuated gear doors close, and the main gear trucks hydraulically tilt to the flight position. When all gear are down and locked, the gear down lights illuminate and the GEAR and DOORS lights extinguish.

The GEAR light remains illuminated and the EICAS caution message GEAR DISAGREE display if any gear is not locked down after the normal transit time. The extinguished gear down light indicates the affected gear. The DOORS light remains illuminated and the EICAS advisory message GEAR DOORS display if any hydraulically actuated door is not closed after the normal transit time.

## Landing Gear Alternate Extension

The alternate landing gear extension system uses a dedicated DC powered electric hydraulic pump. Fluid within the supply line to the pump is sufficient for alternate gear extension operation. This fluid is isolated from the left hydraulic system. Selecting the ALTN GEAR EXTEND switch releases all door and gear uplocks. The landing gear free-fall to the down and locked position.

---

When all gear are down and locked, the gear down lights illuminate and the GEAR light extinguishes. During alternate extension, the DOORS light remains illuminated and the EICAS advisory message GEAR DOORS display because all the hydraulically powered gear doors remain open.

---

## **Nose Wheel Steering**

Nose wheel steering is powered by the left hydraulic system.

Primary steering control is provided by the left sidewall nose wheel steering tiller. Limited steering control is available through the rudder pedals. The tiller can turn the nose wheel up to 65 degrees in either direction. A pointer on the tiller assembly shows tiller position relative to the neutral setting. The rudder pedals can be used to turn the nose wheels up to seven degrees in either direction. Tiller inputs override rudder pedal inputs.

---

## **Brake System**

Each main gear wheel has a multiple disc brake. The nose wheels have no brakes. The brake system includes:

- normal/reserve brake hydraulic system
- alternate brake hydraulic system
- brake accumulator
- antiskid protection
- autobrake system
- parking brake

### **Normal Brake Hydraulic System**

The normal brake hydraulic system is powered by the right hydraulic system. The brake pedals provide independent control of the left and right brakes.

### **Alternate Brake Hydraulic System**

Alternate brake hydraulic system selection is automatic. If the right hydraulic system pressure is low, the left hydraulic system automatically supplies pressure to the alternate brake system. Pushing a brake pedal then sends hydraulic pressure through the alternate antiskid valves to the brakes.

The BRAKE SOURCE light illuminates and the EICAS advisory message BRAKE SOURCE displays if both the normal and the alternate brake system pressures are low.

## Reserve Brakes

Pressing the RESERVE BRAKES switch provides reserve hydraulic fluid to the right system electric pump. Pump pressure is then supplied exclusively to the normal brakes system. The BRAKE SOURCE light extinguishes when pressure is available.

## Brake Accumulator

If right/reserve, and alternate brake hydraulic power is lost, the brake accumulator can provide several braking applications or parking brake application.

## Antiskid Protection

Antiskid protection is provided in the normal/reserve and alternate brake hydraulic systems.

The normal/reserve brake hydraulic system provides each main gear wheel with individual antiskid protection. When a wheel speed sensor detects a skid, the associated antiskid valve reduces brake pressure until skidding stops.

The alternate brake hydraulic system provides antiskid protection to laterally paired wheels.

Touchdown, hydroplaning, and locked wheel protection is provided.

The ANTISKID light illuminates and the EICAS advisory message ANTISKID displays to indicate a fault is detected in the antiskid system.

## Autobrake System

The autobrake system provides automatic braking at pre-selected deceleration rates for landing.

The system operates only when the normal/reserve brake system is functioning. Antiskid system protection is provided during autobrake operation.

The AUTO BRAKES light illuminates and the EICAS advisory message AUTOBRAKES displays if the autobrake system is disarmed or inoperative.

## Rejected Takeoff

Selecting RTO prior to takeoff arms the autobrake system. The RTO mode can be selected only on the ground. The RTO autobrake setting commands maximum braking pressure if:

- the airplane is on the ground
- groundspeed is above 85 knots, and
- both thrust levers are retarded to idle

Maximum braking is obtained in this mode. If an RTO is initiated below 85 knots, the RTO autobrake function does not operate.

---

## Landing

Five levels of deceleration can be selected for landing. However, on dry runways, the maximum autobrake deceleration rate in the landing mode is less than that produced by full pedal braking.

After landing, autobrake application begins when:

- both thrust levers are retarded to idle, and
- the wheels have spun up

Autobrake application occurs slightly after main gear touchdown. Deceleration is limited until the pitch angle is less than one degree, then deceleration increases to the selected level. The deceleration level can be changed (without disarming the system) by rotating the selector.

To maintain the selected airplane deceleration rate, autobrake pressure is reduced as other controls, such as thrust reversers and spoilers, contribute to total deceleration. The system provides braking to a complete stop or until it is disarmed.

### Autobrake – Disarm

The system disarms immediately, the AUTO BRAKES light illuminates and the EICAS advisory message AUTOBRAKES displays if any of the following occur:

- pedal braking applied
- either thrust lever advanced after landing
- speedbrake lever is moved from the full up position after the speedbrakes have deployed on the ground
- DISARM or OFF position selected on the AUTO BRAKES selector
- autobrake fault
- normal antiskid system fault

When the autobrake system disarms after landing, the AUTO BRAKES selector automatically moves to the DISARM position, the AUTO BRAKES light illuminates, and power is removed from the autobrake system.

When the autobrake system disarms during takeoff, the AUTO BRAKES selector remains in the RTO position. After takeoff, the AUTO BRAKES selector automatically moves to OFF.

## Parking Brake

The parking brake can be set with the normal/reserve or alternate brake hydraulic system. If the normal/reserve and alternate brake systems are not pressurized, parking brake pressure is maintained by the brake accumulator. The brake accumulator is pressurized by the right hydraulic system. Accumulator pressure is shown on the BRAKE PRESS indicator.

The parking brake is set by fully depressing both brake pedals, pulling the parking brake handle up, then releasing the pedals. This mechanically latches the pedals in the depressed position and commands the parking brake valve to close.

The parking brake is released by depressing the pedals until the parking brake handle releases.

The PARK BRAKE light illuminates and the EICAS advisory message PARKING BRAKE displays when the parking brake is set.

## **Brake Temperature Indication**

### **[Option - with Brake Temp EICAS display]**

Wheel brake temperatures are displayed on the EICAS status page. Numerical values related to wheel brake temperature are displayed for each main gear brake. Brake temperature values range from 0 to 9. Temperature values are not instantaneous and tend to build for 10 to 15 minutes after brakes are applied.

Initial range values of 0 to 2 are cyan numbers in a cyan box. For normal range values of 3 and 4, the number is cyan and the box is white for the first per truck that exceeds 2. Values in the high range of 5 to 9 have a white number and box. The BRAKE TEMP light illuminates for values of 5 and above.

**Landing Gear EICAS Messages**

**Note:** Configuration warning messages are covered in Chapter 15, Warning Systems.

The following EICAS messages can be displayed.

**Brakes**

Message	Level	Light	Aural	Condition
ANTISKID	Advisory	ANTISKID		A fault is detected in the antiskid system.
AUTOBRAKES	Advisory	AUTO BRAKES		Autobrake is disarmed or inoperative.
BRAKE SOURCE	Advisory	BRAKE SOURCE		Normal and alternate brake system pressures are low.
PARKING BRAKE	Advisory	PARK BRAKE		The parking brake is set.

**Landing Gear**

Message	Level	Light	Aural	Condition
AIR/GND SYS	Advisory			Air/ground sensing system failed.
GEAR DISAGREE	Caution	GEAR	Beeper	Gear position disagrees with landing gear lever position.
GEAR DOORS	Advisory	DOORS		One or more gear doors are not closed.
NOSE A/G SYS	Advisory			Nose air/ground sensing system failed.

Intentionally  
Blank



<b>Controls and Indicators</b> .....	<b>15.10</b>
Engine Indication and Crew Alerting System (EICAS) .....	15.10.1
Primary EICAS Display .....	15.10.1
Secondary EICAS Display .....	15.10.3
EICAS Messages .....	15.10.5
EICAS Status Display .....	15.10.8
EICAS Control Panel .....	15.10.9
Caution Cancel/Recall Switches .....	15.10.9
Warning System Switches and Lights .....	15.10.10
Master Warning/Caution Reset Switches and Lights .....	15.10.10
Miscellaneous Lights .....	15.10.11
Ground Proximity Warning System (GPWS) .....	15.10.12
GPWS Controls .....	15.10.12
GPWS Immediate-Alert Annunciations .....	15.10.13
Enhanced GPWS .....	15.10.14
Windshear Warning System .....	15.10.18
Windshear Immediate-Alert Annunciations .....	15.10.18
Predictive Windshear (PWS) .....	15.10.19
Traffic Alert and Collision Avoidance System (TCAS) .....	15.10.21
TCAS Controls .....	15.10.21
TCAS Displays .....	15.10.23
TCAS Vertical Guidance .....	15.10.26
Miscellaneous Switches .....	15.10.27
Stall Warning Test Switches .....	15.10.27
EICAS Test Switch .....	15.10.27
<b>System Description</b> .....	<b>15.20</b>
Introduction .....	15.20.1
Engine Indication and Crew Alerting System (EICAS) .....	15.20.1
System Alert Messages .....	15.20.1
System Alert Level Definitions .....	15.20.2

---

Communication Alerts . . . . .	15.20.2
Status Messages . . . . .	15.20.2
Alert Message Displays . . . . .	15.20.3
Master Warning/Caution Reset Switches and Lights . . . . .	15.20.3
Flight Deck Panel Annunciator Lights . . . . .	15.20.4
Aural Alerts . . . . .	15.20.4
Alert Inhibits . . . . .	15.20.5
Message Consolidation . . . . .	15.20.6
Engine Start Message Inhibits . . . . .	15.20.6
Takeoff Inhibits . . . . .	15.20.6
Landing Inhibits . . . . .	15.20.7
Engine Shutdown Inhibits . . . . .	15.20.8
Alert Message Inhibits . . . . .	15.20.8
Altitude Alerting Inhibit . . . . .	15.20.8
Master Caution Lights and Beeper Inhibit . . . . .	15.20.9
EICAS Event Record . . . . .	15.20.9
EICAS Failure Indications . . . . .	15.20.9
Warning System . . . . .	15.20.9
Configuration Alerts . . . . .	15.20.10
Airspeed Alerts . . . . .	15.20.11
Altitude Alerts . . . . .	15.20.12
Ground Proximity Warning System (GPWS) . . . . .	15.20.14
Introduction . . . . .	15.20.14
GPWS Alert Prioritization . . . . .	15.20.15
GPWS Immediate-Alert Modes . . . . .	15.20.16
GPWS Callouts . . . . .	15.20.17
Look-Ahead Alerts and Display . . . . .	15.20.18
Windshear Warning System . . . . .	15.20.21
Windshear Immediate-Alerts . . . . .	15.20.21
Predictive Windshear (PWS) . . . . .	15.20.21
Traffic Alert and Collision Avoidance System (TCAS) . . . . .	15.20.25
Normal Operations . . . . .	15.20.25
Resolution Advisories (RA) and Displays . . . . .	15.20.25

---

Traffic Advisories (TA) and Displays . . . . .	15.20.26
Automatic TA and RA Display . . . . .	15.20.27
Proximate Traffic and Other Traffic Displays . . . . .	15.20.27
TCAS Voice Annunciations . . . . .	15.20.28
Inhibits . . . . .	15.20.30
Non-Normal Operations . . . . .	15.20.30
<b>EICAS Messages . . . . .</b>	<b>15.30</b>
Warning Systems EICAS Messages . . . . .	15.30.1
GPWS . . . . .	15.30.1
TCAS . . . . .	15.30.1
Configuration . . . . .	15.30.1
Miscellaneous . . . . .	15.30.2

Intentionally  
Blank

# DO NOT USE FOR FLIGHT

757 Flight Crew Operations Manual

Warning Systems  
Controls and Indicators

Chapter 15  
Section 10

## Engine Indication and Crew Alerting System (EICAS)

### Primary EICAS Display

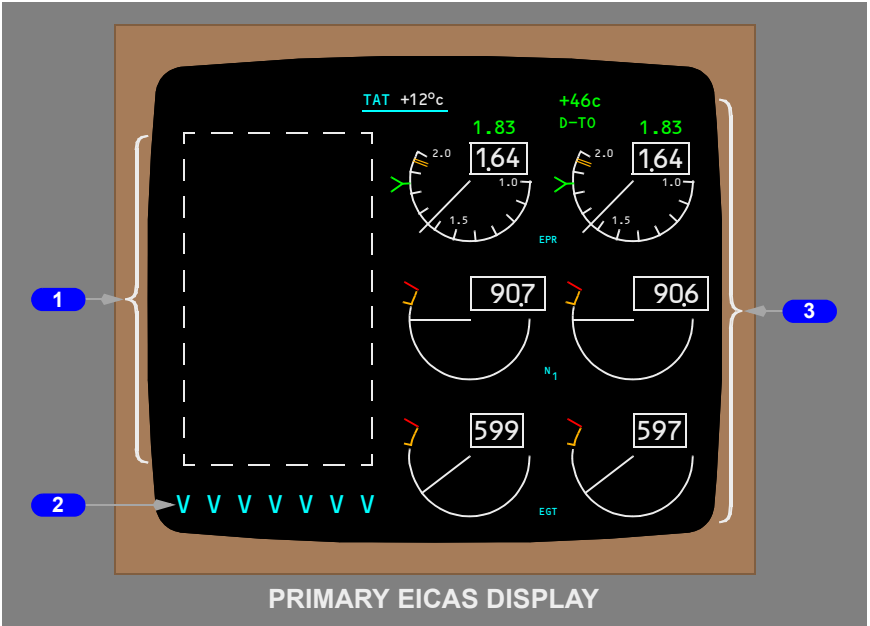

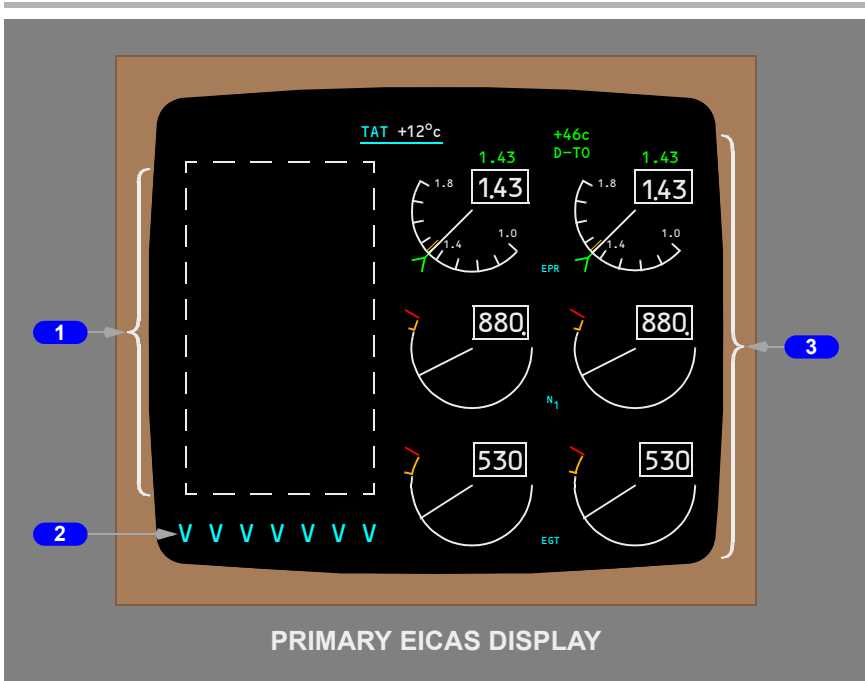

**1 EICAS Message Field**

Eleven lines are available for system and communications alerts.  
Additional pages are available.

**2 Engine Secondary Data Cue**

Displays (cyan) – secondary engine data should be displayed on lower CRT.

**3 Primary Engine Indications**

Displays full time on the EICAS display.

## Secondary EICAS Display

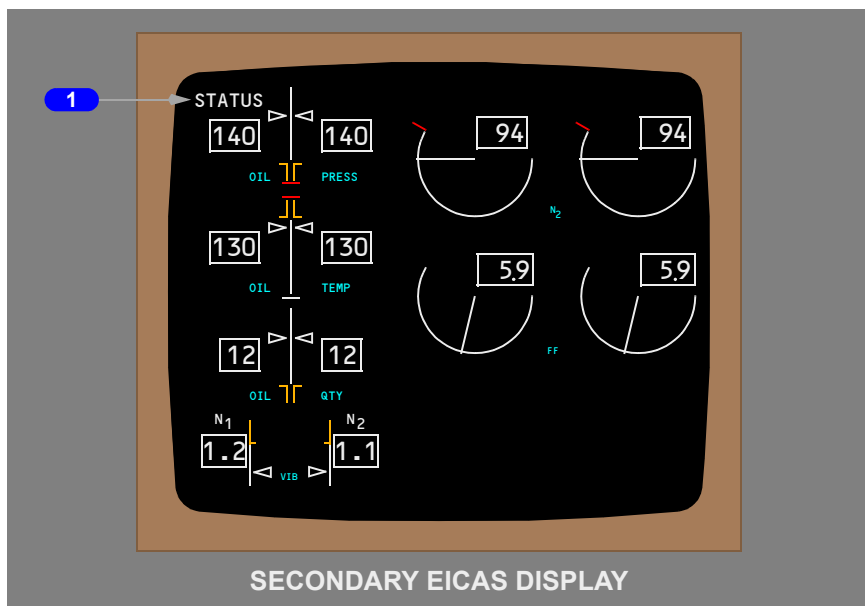
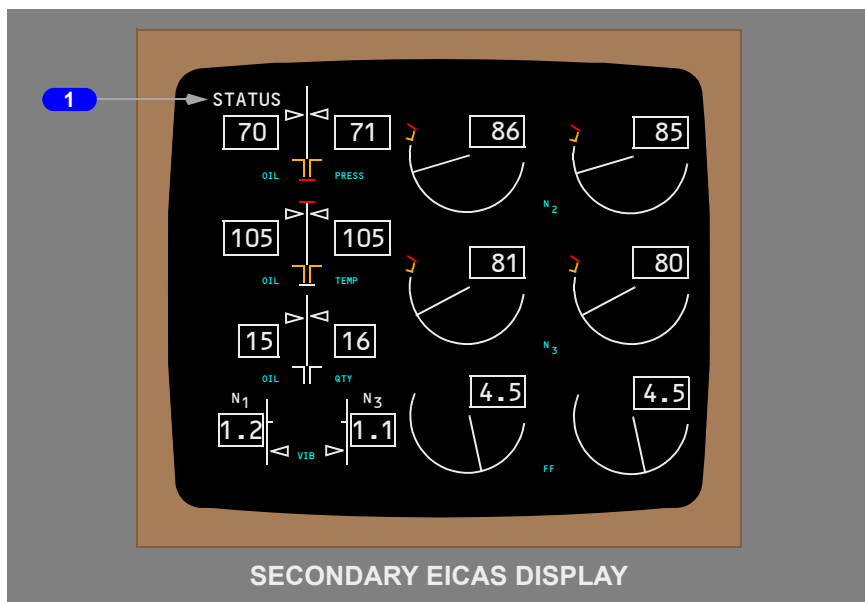

### 1 Status Cue

Displays when a new status message exists.

Removed when the status page is displayed.



## EICAS Messages



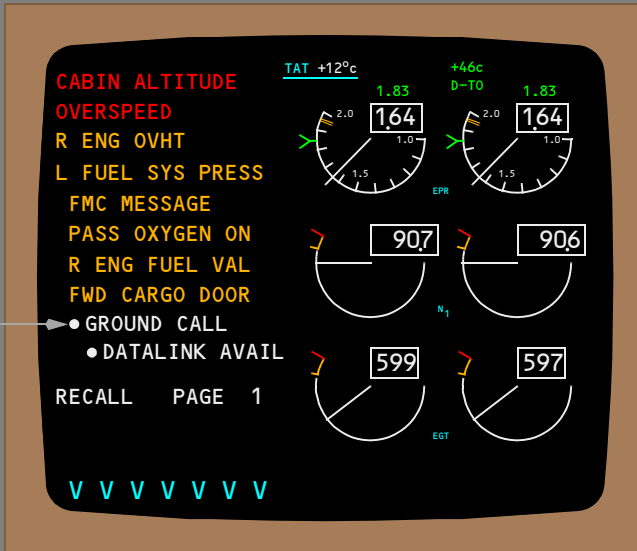

PRIMARY EICAS DISPLAY

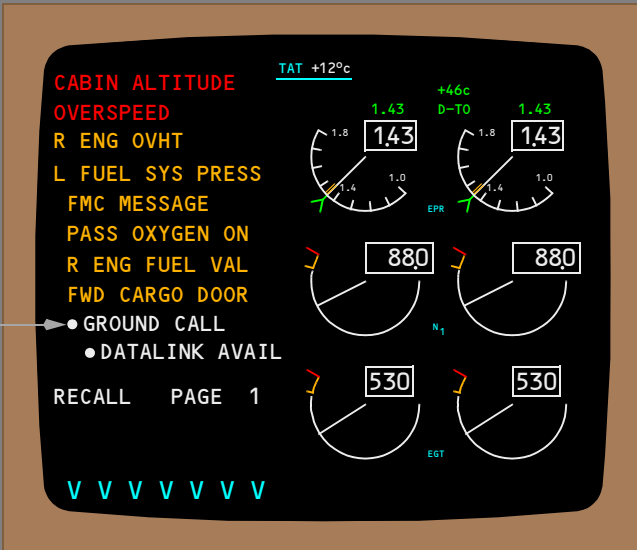

PRIMARY EICAS DISPLAY

---

**1 Warning Messages**

Displays (red) – the highest priority alert messages.

**2 Caution Messages**

Displays (amber) – the next highest priority alert messages after warning messages.

**3 Advisory Messages**

Displays (amber) –

- the lowest priority alert messages
- indented one space.

**4 Recall Indication**

Displays when the RECALL switch is pushed.

Remains displayed for one second after the switch is released.

**5 Page Number**

Displays (white) –

- more than one page of alert or communication messages exists
- indicates the number of the page selected.

**6 Communication Messages**

Displays (white) –

- indicates incoming communication messages
- preceded by a white dot
- COMM LOW messages are indented one space.

## EICAS Status Display

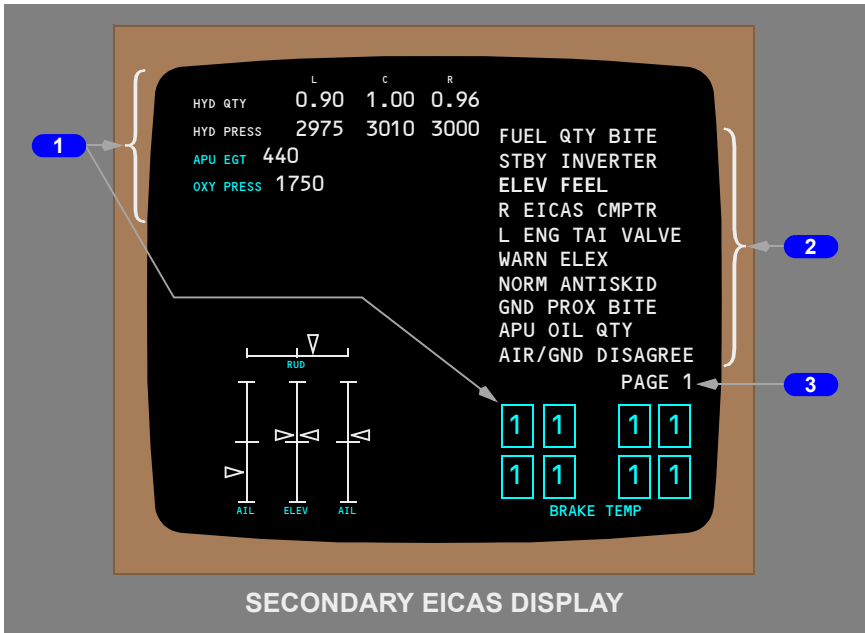

### 1 Status Display

System indications are displayed.

### 2 Status Messages

Status messages indicate conditions requiring minimum equipment list (MEL) reference for dispatch.

### 3 Page Number

A page number appears if additional pages of status messages exist.

## EICAS Control Panel

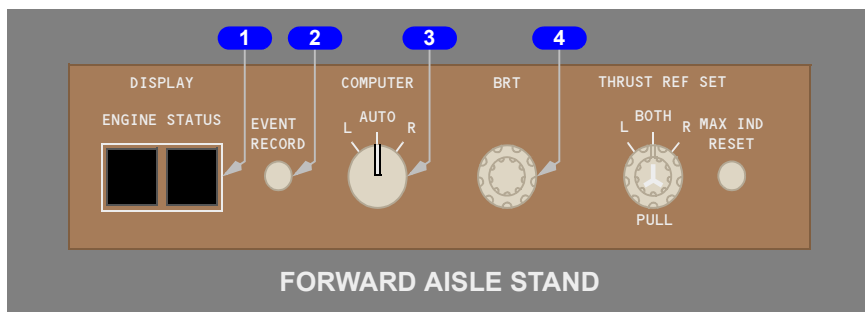

### **1** STATUS Display Switch

Push – displays the status display on the lower EICAS CRT.

Subsequent pushes –

- displays the next page of status messages when additional pages exist
- the status display blanks after the last page of status messages is displayed.

### **2** EVENT RECORD Switch

Push – records the last EICAS event into memory.

### **3** COMPUTER Selector

L – left EICAS computer controls displays.

AUTO – EICAS display control automatically transfers to the right EICAS computer if the left computer fails.

R – right EICAS computer controls displays.

### **4** Brightness (BRT) Control

Rotate –

- Outer control – adjusts brightness of lower display
- Inner control – adjusts brightness of upper display.

## Caution Cancel/Recall Switches

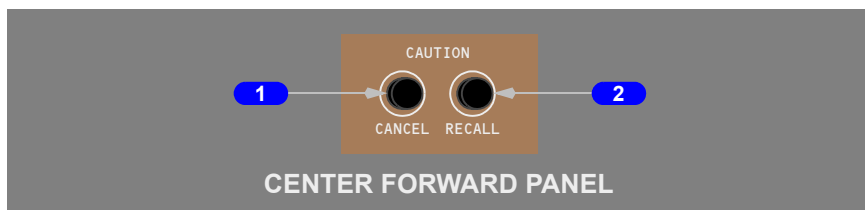

## 1 CANCEL Switch

Push –

- displays the next page of EICAS messages when additional pages exist
- cancels caution and advisory messages when the last page is displayed

**Note:** Warning messages remain.

**Note:** Communication messages remain.

## 2 RECALL Switch

Push –

- displays the previously cancelled EICAS messages, if the associated condition(s) still exist
- displays the first page of messages when multiple pages exist.

## Warning System Switches and Lights

### Master Warning/Caution Reset Switches and Lights

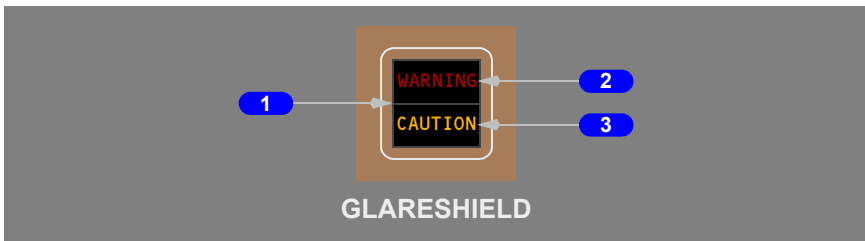

## 1 Master WARNING/CAUTION Reset Switch

Push –

- extinguishes the master WARNING lights
- extinguishes the master CAUTION lights
- silences most associated aural alerts (for exceptions, see Section 20, Master Warning/Caution Reset Switches and Lights).

## 2 Master WARNING Light

Illuminated (red) – a time critical warning or warning condition exists.

## 3 Master CAUTION Light

Illuminated (amber) – a caution condition exists.

## Miscellaneous Lights

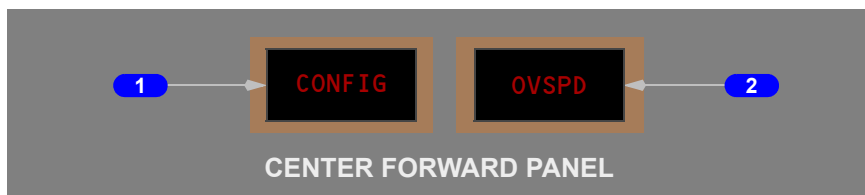

### **1** Configuration (CONFIG) Light

Illuminated (red) – a configuration warning exists.

### **2** Overspeed (OVSPD) Light

Illuminated (red) – airplane is exceeding Mmo or Vmo.



### **1** Altitude Alert (ALT ALERT) Light

ALT ALERT Illuminated (amber) – aircraft altitude:

- between 300 and 900 feet of the altitude selected with the altitude selector

## Ground Proximity Warning System (GPWS)

### GPWS Controls

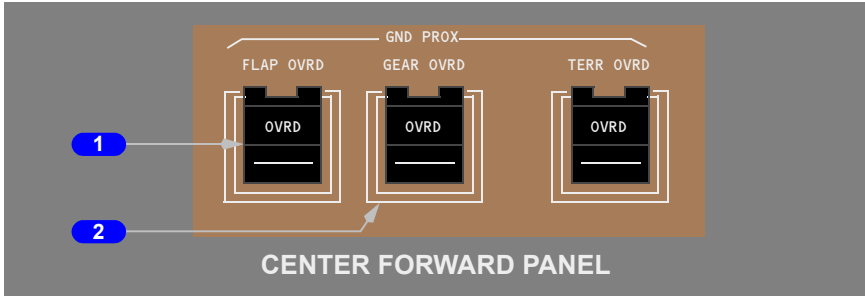

#### 1 Ground Proximity Flap Override (GND PROX FLAP OVRD) Switch Push (OVRD visible) –

- inhibits the ground proximity TOO LOW FLAPS caution
- inhibits the ground proximity TOO LOW TERRAIN caution

**Note:** The EICAS advisory message GND PROX SYS is displayed when FLAP OVRD is selected for more than 60 seconds while airspeed is greater than 250 knots.

#### 2 Ground Proximity Gear Override (GND PROX - GEAR OVRD) Switch

Push (OVRD visible) –

- inhibits the ground proximity TOO LOW GEAR caution
- inhibits the ground proximity TOO LOW TERRAIN caution
- inhibits the landing configuration warning siren

**Note:** The EICAS advisory message GND PROX SYS is displayed when GEAR OVRD is selected for more than 60 seconds while airspeed is greater than 290 knots.

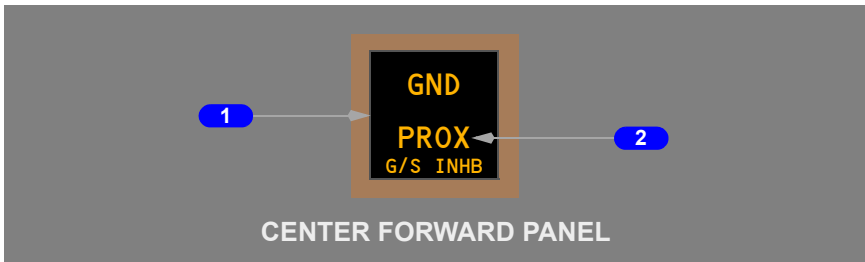



**1 Ground Proximity Glide Slope Inhibit (GND PROX G/S INHB) Switch**

Push –

- inhibits the ground proximity GLIDE SLOPE caution when below 1,000 feet radio altitude

**2 Ground Proximity (GND PROX) Light**

Illuminated (amber) –

- a ground proximity caution exists
- an enhanced GPWS look-ahead caution exists

**GPWS Immediate-Alert Annunciations**

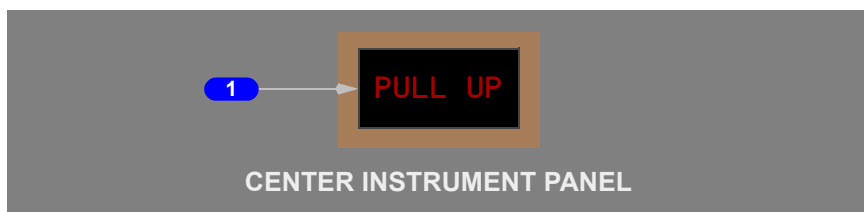

**1 PULL UP Light**

PULL UP (red) –

- the airplane descent rate is severe
- the airplane closure rate with terrain is excessive with the landing gear and/or flaps not in the landing configuration
- an enhanced GPWS look-ahead warning is active

## Enhanced GPWS

### Look-Ahead Display Switches

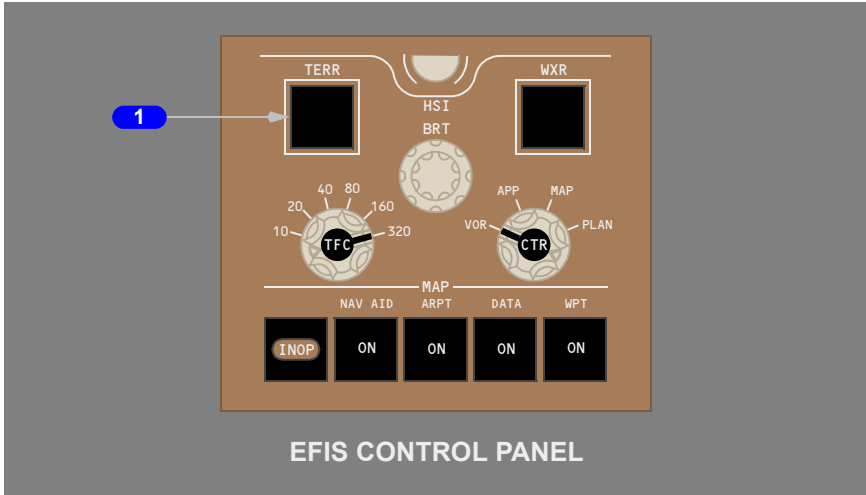

#### **1** Terrain (TERR) Display Select Switch

Push –

- displays GPWS look-ahead data in VOR, APP, MAP, and CTR MAP modes
- deselects the weather radar display
- second push deselects GPWS look-ahead display

### Look-Ahead Override Switches

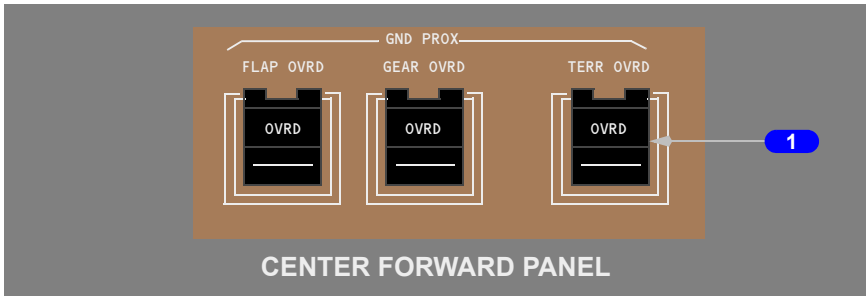

**1 Ground Proximity (GND PROX) Terrain Override (TERR OVRD) Switch**

Push – (OVRD visible)

- inhibits GPWS look-ahead alerts and displays
- second push deselected inhibit

**Terrain Display**

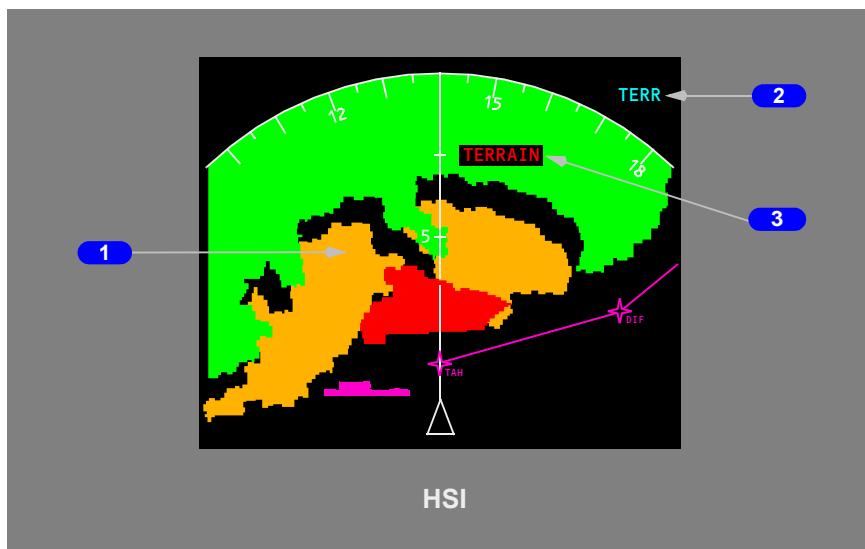

**1 Terrain Display**

Color and density vary based on terrain height verse airplane altitude:

- dotted green: terrain from 2,000 feet below to 500 feet (250 feet with gear down) below the airplane's current altitude
- dotted amber: terrain 500 feet (250 feet with gear down) below to 2,000 feet above the airplane's current altitude
- dotted red: terrain more than 2,000 feet above airplane's current altitude
- dotted magenta: no terrain data available
- solid amber: look-ahead terrain caution active.
- solid red: look-ahead terrain warning active

**Note:** In areas without terrain data, look-ahead terrain alerting and display functions are not available. GPWS immediate-alert modes function normally.

**Note:** Terrain more than 2,000 feet below airplane altitude or within 400 feet of nearest airport runway elevation does not show.

Terrain is displayed automatically when:

- a look-ahead terrain alert occurs; and
- Terrain (TERR) Display Select Switch is not selected by either pilot; and
- HSI Mode Selector in the VOR, APP, MAP, or CTR MAP mode

The look-ahead display updates with a sweep similar to the weather radar display.

## 2 Terrain (TERR) Mode Annunciation

TERR (cyan) – terrain display enabled (manual or automatic display)

## 3 TERRAIN Annunciation

TERRAIN (red):

- terrain warning is occurring
- 20-30 seconds from projected impact with terrain

TERRAIN (amber):

- terrain caution is occurring
- 40-60 seconds from projected impact with terrain

**Note:** TERRAIN annunciation displays in all HSI modes.

## Look-Ahead HSI Systems Annunciations

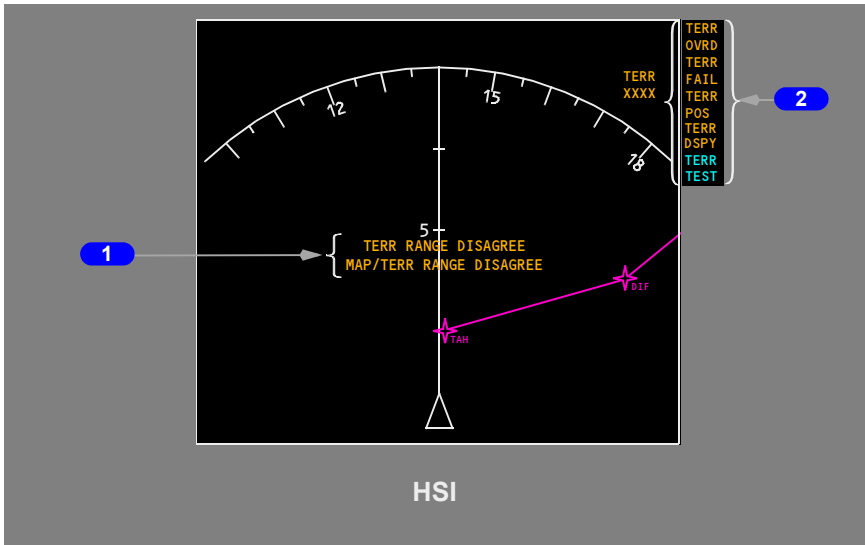

---

**1 Terrain Range Disagree Annunciation**

TERR RANGE DISAGREE (amber) –

- GPWS look-ahead display enabled
- GPWS look-ahead display output range disagrees with the HSI Range Selector

MAP/TERR RANGE DISAGREE (amber) –

- GPWS look-ahead display enabled
- GPWS look-ahead display output range disagrees with the HSI Range Selector
- map display output range disagrees with the HSI Range Selector

**2 GPWS Status/Mode Annunciation**

TERR OVRD (amber) – GND PROX TERR OVRD switch pushed

TERR FAIL (amber) – GPWS look-ahead alerting and display have failed

TERR POS (amber) – GPWS look-ahead alerting and display unavailable due to GPS position uncertainty

TERR TEST (cyan) – GPWS operating in self-test mode

## Windshear Warning System

### Windshear Immediate-Alert Annunciations

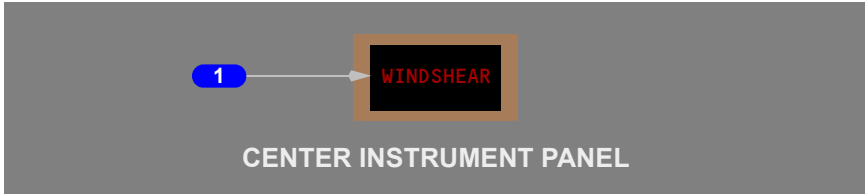

#### 1 WINDSHEAR Light

WINDSHEAR (red) –

- a windshear condition is detected
- GPWS look-ahead modes and all other GPWS immediate-alert modes are inhibited

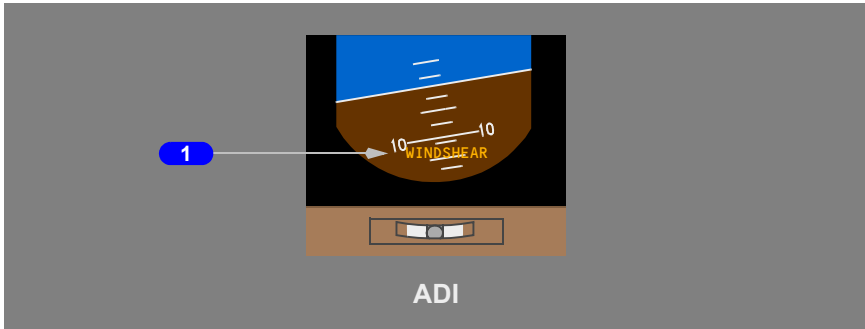

#### 1 WINDSHEAR Annunciation

WINDSHEAR (red) –

- a windshear condition is detected
- GPWS look-ahead modes and all other GPWS immediate-alert modes are inhibited

## Predictive Windshear (PWS)

### PWS Displays and Annunciations

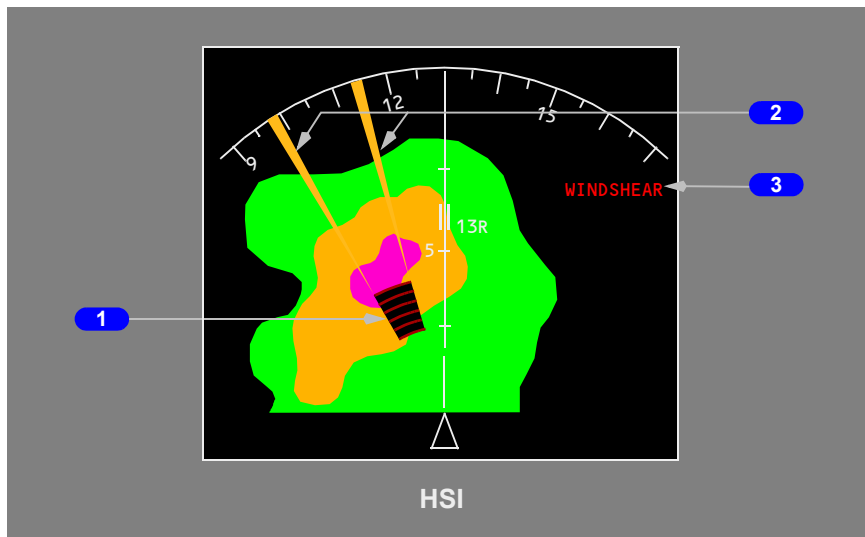

#### 1 PWS Symbol

Displayed (red and black) – PWS alert active

Shows predicted windshear location and approximate geometric size (width and depth).

Symbol, radials and weather radar returns display automatically on an HSI when:

- the aircraft is below 1200' AGL
- a PWS alert occurs
- weather (WXR) display select switch is not selected by either pilot; and
- the respective HSI Mode Selector is in the VOR, APP, MAP or CTR MAP mode

**Note:** The size of the PWS symbol is proportional to the geographic size of the PWS event it represents and bears no relationship to its intensity.

**Note:** If a PWS alert occurs when terrain (TERR) is selected on both pilot HSI displays and there is not an active terrain alert occurring, weather radar display replaces terrain display. The weather radar display, including PWS symbology, can be deselected by pushing the TERR switch for the respective HSI.

**2 PWS Radials**

Displayed (amber) – PWS alert active

Extend from predictive windshear symbol to help identify location of the PWS event.

**3 WINDSHEAR**

WINDSHEAR (red) – PWS warning is active

WINDSHEAR (amber) – PWS caution is active



---

## Traffic Alert and Collision Avoidance System (TCAS)

### TCAS Controls

#### Transponder Panel



#### **1** TCAS Mode Selector

STBY – places transponders and TCAS system in standby

- displays TCAS OFF on HSI

ALT OFF/ALT ON – activates transponders with or without altitude reporting, TCAS system in standby

- displays TCAS OFF on HSI

TA – enables TCAS in Traffic Advisory mode

- display of Traffic Advisory (TA) symbols
- voice alerts
- displays TA ONLY on HSI

TA/RA – enables TCAS in Traffic Advisory and Resolution Advisory mode

- display of Traffic Advisory (TA) and Resolution Advisory (RA) symbols
- voice alerts
- vertical guidance for RAs
- displays TFC on HSI

## EFIS Control Panel

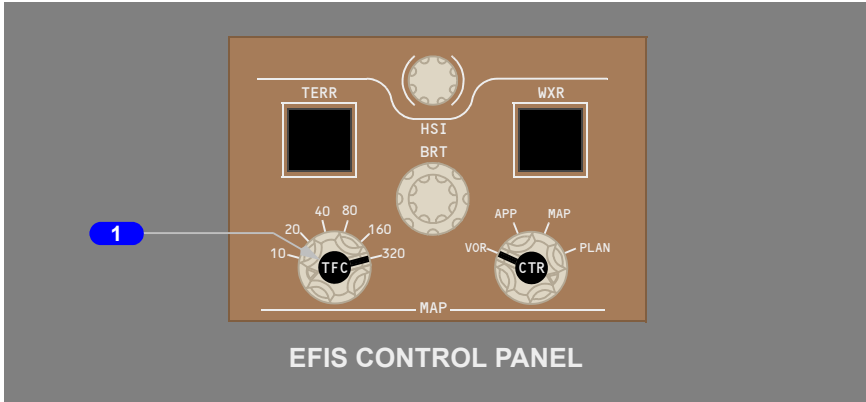

### 1 Traffic (TFC) Switch

**Note:** TCAS must be enabled on the Transponder Panel.

Push –

- displays or removes TCAS traffic information on HSI
- removes TCAS OFF message if displayed
- removes TCAS FAIL message if displayed

## TCAS Displays

### HSI

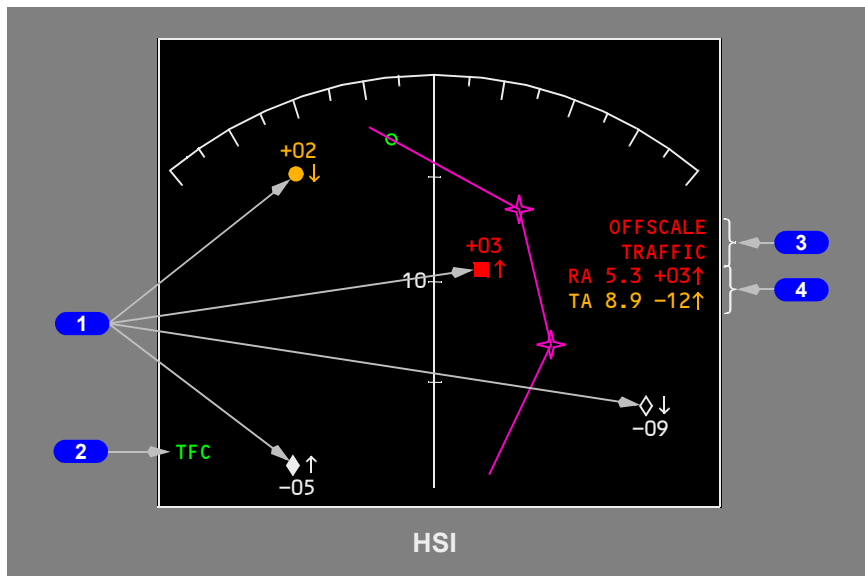

**1** Traffic Aircraft Symbology







Indicates the relative position of traffic aircraft.

**2** Mode Annunciations

**3** Traffic Messages

**4** No-Bearing Symbology

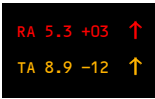
## TCAS Symbolology

Symbol	Name (Color)	Applicable Mode(s)	Remarks
	TCAS resolution advisory (RA), relative altitude (R)	MAP CTR MAP APP VOR	These symbols are displayed only when the EFIS control panel traffic (TFC) switch is selected on.
	TCAS traffic advisory (TA), relative altitude (A)		The arrow indicates traffic climbing or descending at a rate greater than or equal to 500 fpm. At rates less than 500 fpm, the arrow is not displayed.
	TCAS proximate traffic, relative altitude (W)		The number and associated signs indicate altitude of traffic in hundreds of feet relative to the airplane.
	TCAS other traffic, relative altitude (W)		The number is below the traffic symbol when the traffic is below, and above the traffic symbol when the traffic is above the airplane. Absence of the number implies altitude unknown.
	TCAS no bearing message (RA-R, TA-A)	MAP CTR MAP APP VOR	A TA (amber) or RA (red) is occurring and bearing information is not available <ul style="list-style-type: none"> <li>• maximum of two messages</li> <li>• data tag provides distance (nm), relative altitude (hundreds of feet), and vertical motion (in excess of 500 feet per minute)</li> </ul>
	TCAS traffic alert message (RA-R, TA-A)	All	Displayed whenever a TCAS RA or TA is active.  EFIS control panel TFC switch does not have to be selected on.

# DO NOT USE FOR FLIGHT

## 757 Flight Crew Operations Manual

Symbol	Name (Color)	Applicable Mode(s)	Remarks
<b>OFFSCALE</b>	TCAS off scale message (RA-R, TA-A)	MAP CTR MAP APP VOR	Displayed whenever RA or TA traffic is outside the traffic area covered by the HSI range.  Displayed only if the EFIS control panel TFC switch is selected on.
<b>TFC</b>	TCAS mode (G)	MAP CTR MAP APP VOR	Indicates the HSI TCAS display is active and the EFIS control panel TFC switch is selected on.  Not displayed when TCAS TEST, TCAS FAIL, or TCAS OFF is annunciated.
<b>TA ONLY</b>	TCAS mode (G)	All	TCAS control panel Mode Selector in: <ul style="list-style-type: none"> <li>TA</li> </ul> Indicates TCAS computer is not computing RAs.  Displayed whether the EFIS control panel TFC switch is selected on or off.
<b>TCAS OFF</b>	TCAS off message (W)	MAP CTR MAP APP VOR	Displayed when the TCAS/ATC mode switch is not in: <ul style="list-style-type: none"> <li>TA</li> <li>TA/RA</li> </ul> Not displayed if TCAS is failed.
<b>TCAS FAIL</b>	TCAS fail message (A)	MAP CTR MAP APP VOR	Indicates TCAS system failure.
<b>TCAS TEST</b>	TCAS mode (W)	All	Indicates TCAS is operating in the test mode.  Displayed whether EFIS control panel TFC switch is selected on or off.

## TCAS Vertical Guidance

### ADI

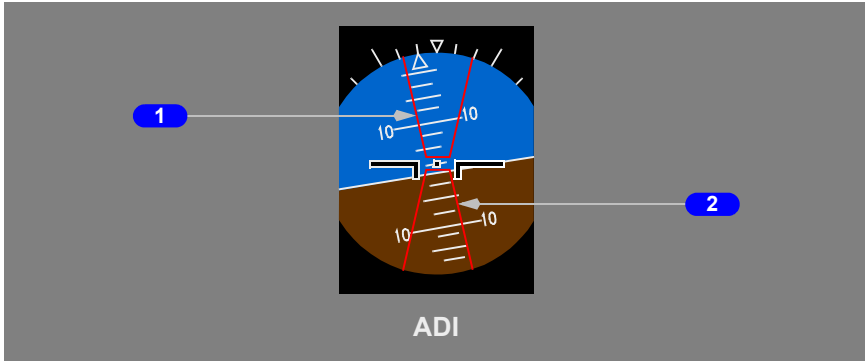

#### 1 Vertical Guidance (Down Advisory)

Displayed (red) –

- a RA is occurring
- indicates pitch attitude region to be avoided for traffic-avoidance maneuver

#### 2 Vertical Guidance (Up Advisory)

Displayed (red) –

- a RA is occurring
- indicates pitch attitude region to be avoided for traffic-avoidance maneuver

**Note:** Both of the TCAS RA pitch commands (above and below) may be displayed at the same time and are shown for clarity.

**Note:** The area inside the red lines indicates the pitch region to avoid in order to resolve the traffic conflict. The center of the airplane symbol must be outside the red RA pitch command area to ensure traffic avoidance.

## Miscellaneous Switches

### Stall Warning Test Switches

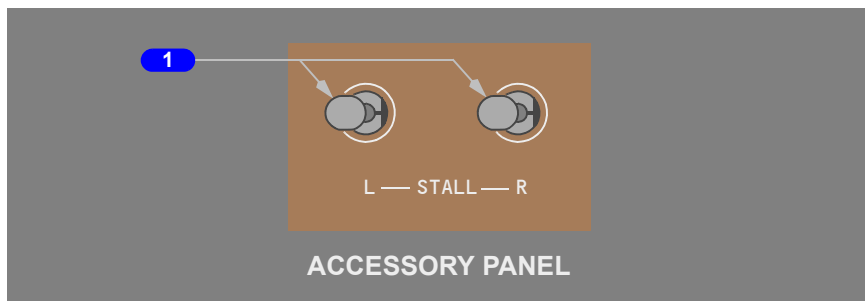

#### **1** Stall (STALL L/R) Warning Test Switch

Spring-loaded to center.

Activates stall warning system.

**CAUTION:** Slats may extend during stall warning test.

### EICAS Test Switch

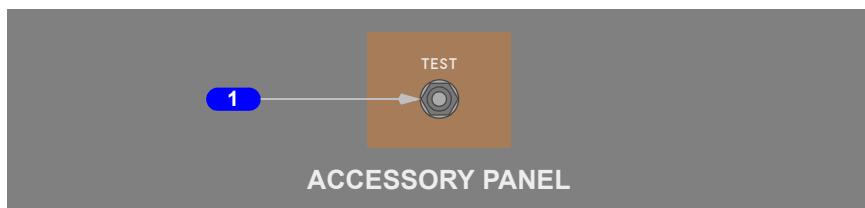

#### **1** TEST Switch

Push – activates EICAS test.

Intentionally  
Blank



---

**Introduction**

The warning systems consist of the following separate systems:

- engine indication and crew alerting system (EICAS)
- warning system
- ground proximity warning system (GPWS)
- traffic alert and collision avoidance system (TCAS)

These systems provide all airplane crew alerting.

Alert is defined as a visual, tactile and/or aural alert requiring crew awareness and possible crew action.

---

**Engine Indication and Crew Alerting System (EICAS)**

EICAS consolidates engine and subsystem indications and provides a centrally located crew alerting message display. EICAS also displays some system status and maintenance information. EICAS provides:

- system alerts
- maintenance information
- status messages
- communication alerts

**System Alert Messages**

System alert messages are associated with aircraft-system failures or faults. These may require performance of non-normal procedures, or affect the way the flight crew operates the airplane. There are four categories of system alert messages:

- time critical warning
- warning
- caution
- advisory.

System alert messages not associated with aircraft-system failures or faults but which may affect the way the flight crew operates the airplane include the following:

- configuration
- airspeed
- altitude
- windshear
- ground proximity warning system (GPWS)
- traffic alert and collision avoidance (TCAS)

- 
- communication messages such as SELCAL, ACARS, ATC or PRINTER
  - FMC messages (See Chapter 11, Flight Management, Navigation)

Non-normal airplane system conditions not affecting the normal airplane operations are annunciated using status or maintenance messages.

## **System Alert Level Definitions**

### **Time Critical Warnings**

Time critical warnings alert the crew of a non-normal operational condition requiring immediate crew awareness and corrective action to maintain safe flight. Time critical warnings are usually associated with primary flight path control. Master WARNING lights, voice alerts, and ADI indications or stick shakers announce time critical warning conditions.

### **Warnings**

Warnings alert the crew to a non-normal operational or system condition requiring immediate crew awareness and corrective action.

### **Cautions**

Cautions alert the crew to a non-normal operational or system condition requiring immediate crew awareness. Corrective action may be required.

### **Advisories**

Advisories alert the crew to a non-normal operational or system condition requiring routine crew awareness. Corrective action may be required.

## **Communication Alerts**

Communication alerts are triggered by the communication management system. These alerts direct the crew to the appropriate message display:

There are three levels of communication alert:

- low – identifies an incoming communication requiring timely awareness and response
- medium – identify an incoming communication requiring immediate awareness and a prompt response. It is accompanied by an aural chime
- high – reserved for future use.

A detailed description of the communication management system is found in Chapter 5, Communications.

## **Status Messages**

Status messages identify system faults affecting airplane dispatch and are not considered crew alerts. The messages are displayed on the EICAS STATUS page.

---

## Alert Message Displays

Alert messages are displayed in both prioritized and chronological order. The priority in descending order is:

- warning (red)
- caution (amber)
- advisory (amber, indented)
- medium-level communication (white, preceded by a dot)
- low-level communication (white, indented, preceded by a dot)

Warnings, cautions, and advisories are displayed from the top down in the EICAS display message area.

The most recent message is displayed at the top of its respective level.

If the number of messages exceeds eleven, the area below the alert field displays a page cue, indicating more than one page of messages is available for display. Paging is accomplished by pushing the CANCEL/RECALL switch on the display select panel.

Warning alerts can only be cleared by correcting the condition causing the warning. All caution and advisory alerts can be cleared. When the last page is displayed, pushing the CANCEL/RECALL switch clears all displayed caution and advisory alerts. Cleared caution and advisory alerts whose conditions still exist can be recalled by pushing the CANCEL/RECALL switch again. This also recalls the first page for review.

Communication alert messages are displayed at the bottom of the message area. Except for the Communication Alert Line, an overflow of system alert messages displaces communication alerts.

The Communication Alert Line, the bottom line of the EICAS message field (line 11), is reserved for a communication alert (medium or low) if one is active. The Communication Alert Line can not be displaced by a system alert even if more than 10 lines are active

Communication alerts are removed when a pilot selects the appropriate switch on the Pilot's call panel.

---

## Master Warning/Caution Reset Switches and Lights

Two Master WARNING/CAUTION reset switches each contain a Master WARNING light and Master CAUTION light.

---

The red Master WARNING lights illuminate when any warning alert or time critical warning occurs (except a stall warning). The lights remain illuminated as long as the warning alert exists or until either Master WARNING/CAUTION reset switch is pushed. Pushing either switch:

- extinguishes both Master WARNING lights
- resets the lights for future warning alerts.

Pushing either Master WARNING/CAUTION reset switch also silences the warning siren and fire bell except for the following warnings:

- landing configuration (for example, when the flaps are in a landing position and landing gear are not down)
- autopilot disconnect
- takeoff configuration

The amber Master CAUTION lights illuminate when any caution alert occurs. The lights remain on as long as the caution alert exists or until either Master WARNING/CAUTION reset switch is pushed. Pushing either switch:

- extinguishes both Master CAUTION lights
- resets the lights for future caution alerts.

---

## Flight Deck Panel Annunciator Lights

Flight deck panel annunciator lights are used in conjunction with EICAS messages to:

- help locate and identify affected systems and controls
- reduce the potential for error.

The annunciator lights provide system feedback in response to flight crew action. The lights also assist in fault detection and system preflight configuration when the engines are shut down and to supplement EICAS information.

---

## Aural Alerts

Aural alerts are provided to ensure crew attention, recognition, and response. Aural alerts include synthetic voices and tones. Aural voice alerts are the most direct and rapid method of communicating a specific alert condition to the crew. Aural tones are used to alert the crew and to discriminate between the different alert types and levels.

Aural alerts annunciate warnings and cautions. There are no aural annunciations associated with advisories.

Aural alerts also annunciate medium-level communication alerts. There are no aural annunciations associated with low-level communication alerts.

---

The aural alerts are:

- **Beeper** – used for all system alert caution level messages. The beeper consists of a tone that sounds four times in a second. The beeper automatically silences after one series of four beeps
- **Bell** – used for fire warnings. The bell sounds repeatedly until crew action is initiated
- **Voice** – synthetic voices announce time critical warning alert conditions. Synthetic voices also announce certain normal but time critical operational information, such as approach phase altitude callouts.

**Option: Overspeed warning is a siren**

- **Siren** – used to announce cabin altitude, autopilot disconnect, configuration and overspeed warning alerts. The siren consists of alternating high and low tones

**Basic: Autopilot disconnect warning is a siren**

- **Siren** – used to announce cabin altitude, autopilot disconnect, configuration warning alerts. The siren consists of alternating high and low tones
- **Siren** – used to announce cabin altitude, configuration and overspeed warning alerts. The siren consists of alternating high and low tones

**Option: Overspeed warning is a clacker**

- **Clacker** – used to announce overspeed warning.

**Option: Autopilot disconnect warning is a wailer**

- **Wailer** – used to announce autopilot disconnect warning.
- **Chime** – a high–low tone chime used for medium-level communication alerts. The chime sounds once for each communication alert.

All continuous aural alerts are silenced automatically when the respective alert condition no longer exists.

---

## Alert Inhibits

Alerts are inhibited during part of the takeoff in order not to distract the crew. Alerts are also inhibited when they are operationally unnecessary or inappropriate.

Alert messages, except for warnings and messages directly relevant to flight operations, are inhibited during engine start to eliminate nuisance messages.

Alert messages are inhibited individually at other times, such as during the preflight and postflight phases or engine shutdown, when they are operationally unnecessary.

## Message Consolidation

On the ground with both engines shut down, certain caution and advisory alert messages are inhibited by collecting them into more general alert messages. These include individual fuel, hydraulic, door, and electrical messages. For example, two or more individual entry, cargo, and access door EICAS messages are replaced by the EICAS advisory message DOORS.

## Engine Start Message Inhibits

During ground engine start, most new caution and advisory alerts are inhibited from engine start switch engagement until one of the following occurs:

- the engine reaches idle RPM
- the start is aborted, or
- 2 minutes elapse from engine start switch engagement.

The following messages are not inhibited:

- ENG FUEL VAL
- ENG SHUTDOWN
- ENG STARTER
- STARTER CUTOUT.

## Takeoff Inhibits

### Warning Inhibits

The Master WARNING lights and fire bell are inhibited for fire during part of the takeoff. The inhibit begins at nose gear extension during rotation and continues until the first to occur:

- 400 feet AGL, or
- 20 seconds elapsed time

If a fire occurs during the inhibit, an EICAS warning message appears, but the fire bell and Master WARNING lights do not activate. If the warning condition still exists when the inhibit is removed, the fire bell and Master WARNING lights activate immediately.

**Note:** Takeoff configuration warnings are terminated at rotation.

### Caution Inhibits

The Master CAUTION lights and aural annunciations are inhibited for all cautions during part of the takeoff. The inhibit begins at 80 knots and continues until the first to occur:

- 400 feet AGL, or
- 20 seconds elapsed time following nose gear extension

If a caution occurs during the inhibit and exists on the ground when the airspeed decreases below 75 knots, both Master CAUTION lights and aural activate.

**Note:** EICAS caution messages are not inhibited during takeoff.

### **Advisory Inhibits**

The following EICAS advisory messages are inhibited on takeoff:

- WINDSHEAR SYS to indicate windshear alerting functions are inoperative.

The inhibit begins from the time either engine is advanced to takeoff thrust and continues until the first to occur:

- 400 feet AGL, or
- 20 seconds after rotation

All other EICAS advisory messages are not inhibited on takeoff.

### **Communication Inhibits**

The following are inhibited during takeoff:

- EICAS communication alert messages such as SELCAL, ACARS, ATC or PRINTER and associated aural chimes. The CABIN ALERT message is not inhibited. The chime associated with the CABIN ALERT message is inhibited

The inhibit begins from the time either engine is advanced to takeoff thrust until the first to occur:

- 400 feet AGL, or
- 20 seconds after rotation

Inhibits are cleared on the ground with both engines below takeoff thrust. If a communication alert message occurs during the inhibit and exists when the inhibit ends, the EICAS alert message and aural chime activate.

## **Landing Inhibits**

### **Communication Inhibits**

The following are inhibited during landing:

- EICAS communication alert messages such as SELCAL, ACARS, ATC or PRINTER and associated aural chimes. The CABIN ALERT message is not inhibited.

The inhibit begins on descent at 800 feet AGL and terminates at:

- less than 75 knots groundspeed
- 900 feet AGL on missed approach

If a communication alert message occurs during the inhibit and exists when inhibit ends, the EICAS alert message and aural chime activate.

## Engine Shutdown Inhibits

Engine-driven pumps, generators, and other components whose alert messages would result from an engine shutdown are inhibited by the ENG SHUTDOWN message. When an engine is shutdown (FUEL CONTROL switch in cut off or fire handle pulled), the EICAS alert message L ENG SHUTDOWN or R ENG SHUTDOWN is displayed and the following L or R alerts are inhibited:

- ENG BLEED OFF
- GEN DRIVE
- GEN OFF
- ENG ANTI-ICE
- ENG OIL PRESS
- HYD ENG PUMP
- ENG EEC
- ENG LIMITER

When the airplane is on the ground and both FUEL CONTROL switches are in the CUT OFF position, the Master CAUTION lights and the caution alert beeper are inhibited. This prevents alerts associated with routine gate operations from triggering nuisance lights and aural alerts.

When the shutdown inhibit is removed, the Master CAUTION lights and alert beeper do not activate for alerts that existed prior to its removal. For example, if the right hydraulic system is depressurized with both engines shutdown, and the left engine is then started, the Master CAUTION lights and beeper do not activate. The Master CAUTION lights and beeper activate only when the alert first occurs, provided no other inhibit is in effect.

## Alert Message Inhibits

Alert message inhibits are those inhibits where one message is inhibited by the presence of another alert message. For example, individual fuel or hydraulic pump pressure messages are inhibited by higher priority system pressure messages.

Certain alert messages are time delayed, even though discrete system lights may illuminate. Time delay inhibits prevent normal in-transit indications from appearing as EICAS system alert messages. For example, valves are generally only sensed open and/or closed, not in-transit. When a valve is in-transit, the alert message indicating the valve has failed to open or close is inhibited to allow the valve time to move to the commanded position. If the valve is not in the commanded position at the end of the inhibit period, an EICAS system alert message is displayed.

## Altitude Alerting Inhibit

Altitude alerting is inhibited in flight with all landing gear down and locked.



## **Master Caution Lights and Beeper Inhibit**

The Master CAUTION lights and the associated alert beeper are inhibited for the L and R ENG SHUTDOWN caution level message.

## **EICAS Event Record**

The flight crew can manually capture and record any suspect condition into EICAS memory using the EICAS EVENT RECORD switch.

Systems which provide recorded information when the switch is activated include:

- anti-ice, ice detection
- air systems
- APU
- electrical
- electronic engine control
- fire protection
- flight controls/flaps and slats
- fuel quantity and fuel management
- hydraulic
- landing gear and brakes
- performance.

Only the last manual event recorded will be retained for future retrieval. The event record function also has an automatic feature. When an EICAS event occurs, conditions are automatically written to EICAS memory.

## **EICAS Failure Indications**

If a fault is detected in one of the cathode ray tubes (CRTs), the faulty display is blanked. Engine indications and crew alerting messages appear on the operable display. An EICAS DISPLAY advisory message displays when one CRT fails.

To ensure that all engine indications can be displayed with a CRT failure, an EICAS compacted display mode is available. The compacted display mode is described in the Engines, APU chapter.

If the EICAS control panel fails an EICAS CONT PNL advisory message displays and the EICAS full up engine mode automatically displays. The full engine mode is described in Chapter 7, Engines, APU. The cancel and recall switches will not operate when the EICAS control panel fails, however, brightness and computer select controls remain operative.

If both EICAS computers or CRTs fail, a standby engine indicator (SEI) is automatically activated. The SEI, system lights and indicators are used to monitor the engines and system operation when a total EICAS failure occurs.

---

## **Warning System**

The warning system consists of two flight deck warning speakers, two Master WARNING lights and two stick shaker motors.

The warning system controls and activates visual, tactile and/or aural alerts for the following:

- fire (See Chapter 8, Fire Protection)
- cabin altitude (See Chapter 2, Air Systems)
- autopilot disconnect (See Chapter 4, Automatic Flight)
- configuration
- airspeed
- altitude
- ground proximity warning system (GPWS)
- windshear
- traffic alert and collision avoidance system (TCAS)

## Configuration Alerts

### Takeoff

Takeoff configuration warnings are armed when the airplane is on the ground and thrust is in the takeoff range on either engine. Takeoff configuration warnings consist of:

- Master WARNING lights illuminate
- CONFIG warning light illuminates
- aural warning siren sounds
- applicable EICAS configuration warning alert message(s) are displayed.

Takeoff configuration warning messages include:

- FLAPS
- PARKING BRAKE
- SPOILERS
- STABILIZER.

Existing takeoff configuration warning are:

- cancelled when the configuration error is corrected
- terminated at rotation

When a takeoff configuration warning occurs, pushing either Master WARNING/CAUTION reset switch resets the Master WARNING lights but does not silence the siren or clear the EICAS alert message. Before reaching rotation, the siren can be silenced and the EICAS alert message cleared only by retarding both thrust levers or correcting the condition. If thrust is reduced, the EICAS takeoff configuration message remains displayed for 10 seconds so the pilots can positively identify the configuration problem.

Holding the configuration test switch in the takeoff (T/O) position simulates accelerating an engine to takeoff power. No warnings occur when testing an airplane properly configured for takeoff. If the airplane is not configured for takeoff a configuration warning results. Releasing the test switch cancels the test.

---

## Landing

The landing configuration warning system alerts the crew that the landing gear is not extended for landing. The landing configuration warning activates if:

- the airplane is in flight, and
- any landing gear is not down and locked, and
- either of the following conditions exists:
  - flaps in a landing position (25 or 30), or
  - any thrust lever is at idle with radio altitude below 800

The landing configuration warning consists of:

- Master WARNING lights illuminate
- CONFIG warning light illuminates
- aural warning siren activates
- the GEAR NOT DOWN EICAS warning alert message is displayed.

With the flaps in a landing position, the siren and alert message cannot be deactivated with the Master WARNING/CAUTION reset switches. The siren and message continue until the condition is corrected or the gear override switch is pushed.

If the warning is due to an idle thrust setting at low altitude, pushing either Master WARNING/CAUTION reset switch silences the siren and extinguishes the Master WARNING lights. The EICAS message remains displayed until the configuration error is corrected.

Holding the configuration test switch in the landing (LDG) position results in a configuration warning regardless of landing gear position. All warning indications disappear when the switch is released.

## Airspeed Alerts

### Stall Warning

Warning of an impending stall is provided by left and right stick shakers, which independently vibrate the left and right control columns. Both systems are energized in flight and deactivated on the ground through air/ground logic.

If the leading edges slats are in the takeoff position and the left hydraulic system is pressurized, a stall warning also causes the slats to extend to the landing position. The flap lever does not move. The slats automatically retract back to the takeoff position after the stall warning no longer exists.

Holding either the L or R stall warning test switch:

- checks the respective stall warning systems
- extends the slats from the takeoff to the landing position if the left hydraulic system is pressurized

## Overspeed Warning

An overspeed warning occurs if V<sub>mo</sub>/M<sub>mo</sub> limits are exceeded. The overspeed warning consists of:

- Master WARNING lights illuminate
- OVSPD light illuminates
- the EICAS warning alert message OVERSPEED is displayed
- aural warning siren sounds

### Option: Overspeed warning is a clacker

- aural warning clacker sounds

All warning indications remain activated until airspeed is reduced below V<sub>mo</sub>/M<sub>mo</sub>.

### Basic: Overspeed warning is resetable

The aural warning can be silenced by pushing either Master WARNING/CAUTION reset switch.

## Altitude Alerts

Altitude alerting occurs when approaching or departing the MCP–selected altitude.

### Approaching a Selected Altitude

At 900 feet prior to reaching the selected altitude, the ALT light on each pilot's altimeter illuminates. At 300 feet prior to reaching the selected altitude, the ALT lights extinguish.

### Deviating From a Selected Altitude

When deviating by 300 feet from the selected altitude:

- the Master CAUTION lights illuminate
- the caution aural sounds
- the EICAS caution message ALTITUDE ALERT is displayed
- the ALT ALERT light illuminates.

When deviating more than 900 feet from the selected altitude, or upon returning to within 300 feet of the selected altitude:

- the Master CAUTION lights extinguish
- the EICAS caution message is no longer displayed
- The ALT ALERT light extinguishes.

## Resetting To A Selected Altitude

Altitude alerting is reset when:

- the airplane returns to within 300 feet of the altitude selected or deviates more than 900 feet from the altitude selected
- the MCP-selected altitude is changed

## Altitude Alert Inhibits

Altitude alerting is inhibited in flight with all landing gear down and locked.

## Altitude Alert Profile

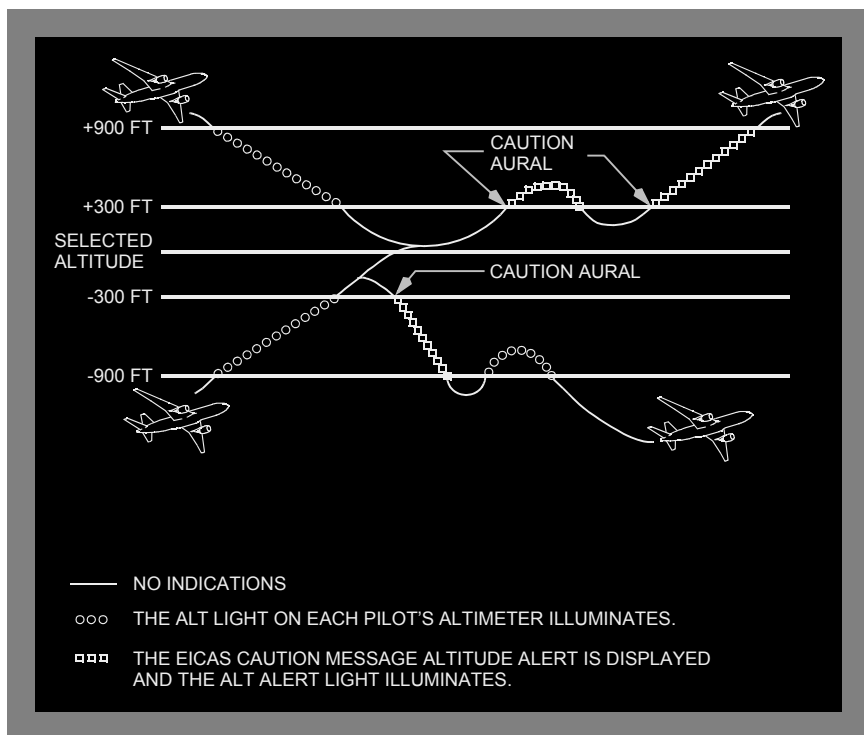

---

## Ground Proximity Warning System (GPWS)

### Introduction

GPWS provides time-critical alerts for potentially hazardous flight conditions involving imminent impact with the ground. GPWS is enabled whenever power is applied to the airplane. Override or inhibit switches allow the flight crew to inhibit certain GPWS alerts.

GPWS also provides voice callouts (Mode 6) to assist the flight crew with situational awareness and to advise the flight crew of the aircraft's approximate height above the ground.

GPWS also provides time-critical alerts for potential hazardous flight conditions involving windshear.

In addition to aircraft configuration, GPWS requires inputs from the following for proper operation:

- air data system
- inertial reference system
- instrument landing system
- radio altimeters

**Note:** Loss of an input does not necessarily inhibit operation of the entire GPWS.

GPWS immediate alerts are radio altitude based and provided for the following:

- excessive and severe descent rate (Mode 1)
- excessive terrain closure rate (Mode 2)
- altitude loss after takeoff or go-around (Mode 3)
- unsafe terrain clearance when not in the landing configuration (Mode 4)
- excessive deviation below an ILS glide slope (Mode 5)
- windshear (Mode 7)

### Enhanced GPWS

In addition to standard alerts, enhanced GPWS provides look-ahead terrain awareness, including alerting and display functions. These functions compare the airplane's geographic position and altitude against an internal terrain database to predict and display potential conflicts between the airplane flight path and terrain.

In addition to standard GPWS inputs, enhanced GPWS requires inputs from the following for proper operation:

- global positioning system

**Note:** Loss of an input does not necessarily inhibit operation of the entire GPWS.

**GPWS Alert Prioritization**

GPWS and Windshear Warning System alerts are prioritized based on the level of hazard and the required flight crew response. The following are listed in order of decreasing priority:

**GPWS Alerts**

<b>Condition</b>	<b>Alert Level</b>	<b>Description</b>
Windshear - Immediate	Warning	Mode 7 - Actual windshear conditions (downdraft) A windshear immediate-alert warning inhibits all other GPWS and windshear alerts.
Ground proximity - Immediate	Warning	Mode 1 - Severe descent rate
Ground proximity - Immediate	Warning	Mode 2 - Severe terrain closure rate
Terrain - Awareness	Warning	Look-Ahead - Terrain along flight path (Near)
Windshear - Awareness	Warning	Predictive - Windshear condition along flight path
Ground proximity - Immediate	Caution	Mode 2 - Excessive terrain closure rate
Terrain - Awareness	Caution	Look-Ahead - Terrain along flight path
Ground proximity - Immediate	Caution	Mode 4 - Unsafe terrain clearance
Altitude - Awareness		Mode 6 - Altitude callouts
Ground proximity - Immediate	Caution	Mode 4 - Unsafe terrain clearance - Gear
		Mode 4 - Unsafe terrain clearance - Flaps
		Mode 1 - Excessive descent rate
		Mode 3 - Descent (sink rate) after takeoff
		Mode 5 - Below glideslope - ILS deviation

Condition	Alert Level	Description
Windshear - Awareness	Caution	Predictive - Windshear adjacent to flight path

### GPWS Immediate-Alert Modes

GPWS immediate-alert warnings (Modes 1-2) are accompanied by:

- visual alerts (see tables)
- aural alerts (see tables)

If illuminated, pushing a Master WARNING/CAUTION Reset switch resets the Master WARNING lights but does not inhibit the GPWS warning.

GPWS immediate-alert cautions (Modes 1-5) are accompanied by:

- visual alerts (see tables)
- voice aural alerts (see tables)

### GPWS Immediate-Alert Warnings

Aural Alert	Visual Alert	Description
PULL UP	PULL UP light (Red)  Master WARNING lights	Follows SINK RATE alert if descent rate becomes severe. (Mode 1)  Follows TERRAIN alert if excessive terrain closure rate continues and landing gear and/or flaps are not in landing configuration. (Mode 2)

### GPWS Immediate-Alert Cautions

Aural Alert	Visual Alert	Description
TERRAIN	GND PROX light (amber)	Excessive terrain closure rate. (Mode 2)
DON'T SINK	GND PROX light (amber)	Excessive altitude loss after takeoff or go-around. (Mode 3)
GLIDE SLOPE	GND PROX light (amber)	Deviation below glide slope. (Mode 5)  Volume and repetition rate increase as deviation increases.  <b>Note:</b> Pushing the ground proximity G/S INHB switch cancels or inhibits the alert below 1,000 feet radio altitude.
SINK RATE	GND PROX light (amber)	Excessive descent rate. (Mode 1)



Aural Alert	Visual Alert	Description
TOO LOW, FLAPS	GND PROX light (amber)	Unsafe terrain clearance at low airspeed with flaps not in landing configuration. (Mode 4)  <b>Note:</b> Pushing the GND PROX FLAP OVRD switch to OVRD inhibits the alert.
TOO LOW, GEAR	GND PROX light (amber)	Unsafe terrain clearance at low airspeed with landing gear not down. (Mode 4)  <b>Note:</b> Pushing the GND PROX GEAR OVRD switch to OVRD inhibits the alert.
TOO LOW, TERRAIN	GND PROX light	Follows DON'T SINK if another descent is initiated after initial alert and before climbing to the altitude where the initial descent began. (Mode 3)  Unsafe terrain clearance at low airspeed with either landing gear not down or flaps not in landing position. (Mode 4)  <b>Note:</b> Pushing the GRND PROX FLAP OVRD switch to OVRD inhibits the alert, when the alert is due to flaps not in landing position.  <b>Note:</b> Pushing the GRND PROX GEAR OVRD switch to OVRD inhibits the alert, when the alert is due to gear not down.

## GPWS Callouts

GPWS provides callouts or aural alerts to assist the flight crew with situational awareness and to advise the flight crew of the aircraft's approximate height above the ground.

Callout	Description
BANK ANGLE, BANK ANGLE	Voice callout occurs when airplane roll angle reaches: <ul style="list-style-type: none"> <li>• 35 degrees</li> <li>• 40 degrees</li> <li>• 45 degrees</li> </ul> <b>Note:</b> Callout is reset when roll angle decreases below 30 degrees.

Callout	Description
FIVE HUNDRED	Airplane is at 500 feet AGL
ONE HUNDRED	Airplane is at 100 feet AGL
FIFTY	Airplane is at 50 feet AGL
FORTY	Airplane is at 40 feet AGL
THIRTY	Airplane is at 30 feet AGL
TWENTY	Airplane is at 20 feet AGL
TEN	Airplane is at 10 feet AGL
MINIMUMS	Airplane reaching the DH set in the captain's Decision Height Reference Window.

### Look-Ahead Alerts and Display

Enhanced GPWS provides look-ahead alerts for potentially hazardous flight conditions involving impact with the ground. GPWS monitors terrain proximity and generates a display from a world-wide terrain data base in the GPWS computer. The data base contains detailed terrain data near major airports and data in lesser detail for areas between airports.

Airplane horizontal position is determined using the:

- global positioning system. If GPS data is intermittently unavailable, GPWS derives horizontal position from the IRS.

Barometric altitude errors induced from temperature extremes or from non-standard pressure altitudes are minimized. Airplane vertical position is determined using a blended solution calculated from the following:

- GPS altitude
- barometric altitude
- radio altitude
- static air temperature

### Look-Ahead Displays

When the EFIS control panel terrain (TERR) display select switch is pushed on, the TERR annunciation is displayed on the HSI and terrain contours may be displayed.

GPWS look-ahead data and weather radar returns cannot be displayed simultaneously on an HSI. If either pilot selects terrain while the other selects weather radar, each display updates on alternating sweeps. All other navigation displays can be simultaneously displayed with terrain data.

When the airplane is lower than 2,000 feet above the terrain, terrain within 2,000 feet of airplane barometric altitude is displayed on the HSI. Non-threat terrain is depicted as several densities of dot patterns in green, amber, or red depending on relative vertical distance between the airplane and the terrain.

When the airplane is higher than 2,000 feet above the terrain or within 400 feet of the nearest airport runway elevation, terrain is not displayed.

**Note:** The GPWS look-ahead display is not designed to be used as an independent navigation aid.

### **Look-Ahead Alerting**

The enhanced GPWS computer continuously computes clearance envelopes looking down and ahead of the airplane. Estimated time to impact is calculated from airplane position, barometric altitude, present track, vertical path, and ground speed. FMC VNAV or LNAV (Refer to Chapter 11, Flight Management, Navigation) paths are not considered in the estimated time to impact.

When the terrain clearance boundaries are crossed the GPWS issues alerts. Alert levels, warning or caution, are based on estimated time to impact. Look-ahead alerts will cause the GPWS look-ahead awareness display to "pop-up" when:

- the HSI display is in an appropriate mode (see tables)
- neither terrain (TERR) display select switch is ON

GPWS look-ahead warning alerts are accompanied by:

- visual alerts (see tables)
- voice aural alerts (see tables)
- solid red terrain displayed on HSIs

If illuminated, pushing a Master WARNING/CAUTION Reset switch resets the Master WARNING lights but does not inhibit the GPWS warning.

GPWS look-ahead caution alerts are accompanied by:

- visual alerts (see tables)
- voice aural alerts (see tables)
- solid amber terrain displayed on HSIs

**Note:** Terrain ahead of the airplane may exceed available climb performance. A GPWS caution or warning alert does not guarantee terrain clearance.

### Look-Ahead Alerting - Warnings

Aural Alert	Visual Alert	Description
TERRAIN TERRAIN PULL UP	PULL UP light (red)  Master WARNING lights  Solid red terrain on HSI  Red TERRAIN annunciation on both HSIs	20 to 30 seconds from projected impact with terrain shown solid red on the HSI.  Pop-up look-ahead display is only available in the following modes:  • VOR, APP, MAP and CTR MAP  <b>Note:</b> Pushing the GRD PROX TERR OVRD switch to OVRD inhibits the alert.

### Look-Ahead Alerting - Cautions

Aural Alert	Visual Alert	Description
CAUTION TERRAIN	Solid amber terrain on HSI  GND PROX light  Amber TERRAIN message on both HSIs	40 to 60 seconds from projected impact with terrain shown in solid amber on the HSI.  Pop-up look-ahead display is only available in the following modes:  • VOR, APP, MAP and CTR MAP  <b>Note:</b> Pushing the GRD PROX - TERR OVRD switch to OVRD inhibits the alert.
TOO LOW, TERRAIN	GND PROX light (amber)	Terrain Clearance Floor (TCF) alert indicating unsafe terrain clearance based on current airplane location, nearest runway center point and radio altitude. Similar to Mode 4 but available in all flight modes.  <b>Note:</b> Pushing the GND PROX - TERR OVRD switch to OVRD inhibits the alert.

---

## Windshear Warning System

The GPWS takes additional data from the stall warning computer (STC) and determines if windshear conditions are occurring in the immediate vicinity of the airplane.

In addition, the GPWS computer takes weather radar data and determines if windshear conditions are occurring ahead of the airplane track.

### Windshear Immediate-Alerts

GPWS issues Windshear Immediate-Warnings whenever decreasing-performance windshear conditions are present during takeoff, approach and landing.

Windshear warnings are accompanied by:

- visual alerts (see tables)
- voice or aural alert (see tables)

If illuminated, pushing a Master WARNING/CAUTION reset switch resets the Master WARNING lights but does not deactivate the windshear warning.

### Windshear Immediate-Alert Warnings

Aural Alert	Visual Alert	Description
Two-tone siren followed by WINDSHEAR	Red WINDSHEAR light Master WARNING lights Red WINDSHEAR on both ADIs	Excessive windshear at the current airplane position Enabled below 1,500 feet radio altitude GPWS Windshear detection begins at rotation

### Predictive Windshear (PWS)

The weather radar (See Chapter 11, Flight Management, Navigation) provides predictive windshear (PWS) alerts when it detects disturbed air ahead of the aircraft which contains moisture or particulate matter and which fits a known pattern of windshear activity.

The PWS alert area ahead of the aircraft is shown as follows:

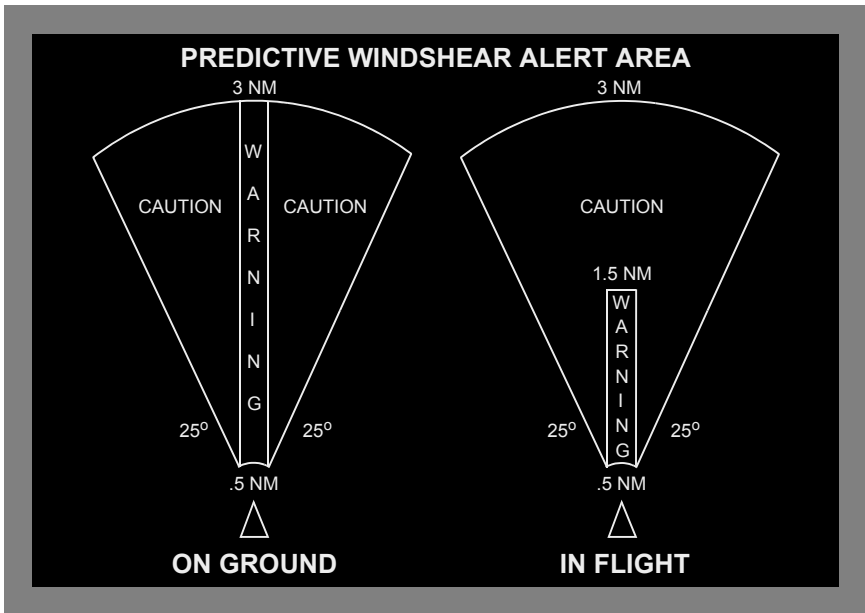

When the PWS mode is enabled, the radar system is time-shared between the weather display and the PWS display. During the time-share:

- the weather display is slower to update
- PWS alerts are available approximately 12 seconds after the system begins scanning
- PWS automatically, regardless of actual Weather Radar Control Panel settings, adjusts the antenna TILT and the system GAIN for optimum windshear detection

The PWS mode is automatically enabled when:

- on the ground, the thrust levers are set for takeoff
- in flight, the aircraft is below 2,300 feet AGL

PWS alerts are automatically enabled below 1,200 feet AGL. If a PWS alert occurs when weather (WXR) is not selected on either pilot HSI displays and there is not an active terrain alert occurring; the weather radar display, including PWS symbology, automatically pops-up on the HSI.

PWS warnings are accompanied by:

- visual alerts (see tables)
- voice or aural alerts (see tables)

If illuminated, pushing a Master WARNING/CAUTION reset switch resets the Master WARNING lights but does not deactivate the windshear warning.

PWS caution alerts are accompanied by:

- visual alerts (see tables)
- voice or aural alerts (see tables)

**Note:** PWS does not provide alerting for all types of windshear. The flight crew must continue to rely on traditional windshear avoidance methods.

**PWS Warnings**

Aural Alert	Visual Alert	Description
WINDSHEAR AHEAD WINDSHEAR AHEAD	Red WINDSHEAR annunciation on both ADIs WINDSHEAR light MASTER WARNING lights RED and BLACK PWS symbol on HSI Red WINDSHEAR annunciation on HSI (all modes)	Enabled during takeoff, below 1,200 feet AGL.  Windshear within 3.0 miles and directly ahead of the airplane.  If weather (WXR) is not selected on either HSI, the weather display, including PWS symbology, will automatically pop-up on the HSI.  PWS symbol on the HSI shows windshear position and size only when the HSI Mode Selector is in the VOR, APP, MAP or CTR MAP mode.
GO AROUND, WINDSHEAR AHEAD	Red WINDSHEAR annunciation on both ADIs WINDSHEAR light MASTER WARNING lights RED and BLACK PWS symbol on HSI Red WINDSHEAR annunciation on HSI (all modes)	Enabled during approach, below 1,200 feet AGL.  Windshear within 1.5 miles and directly ahead of the airplane.  If weather (WXR) is not selected on either HSI, the weather display, including PWS symbology, will automatically pop-up on the HSI.  PWS symbol on the HSI shows windshear position and size only when the HSI Mode Selector is in the VOR, APP, MAP or CTR MAP mode.

**PWS Cautions**

Aural Alert	Visual Alert	Description
MONITOR RADAR DISPLAY	RED and BLACK PWS symbol on HSI  Amber WINDSHEAR annunciation on HSI	Windshear within 3 miles and not directly ahead of the airplane  Enabled during takeoff and approach, below 1,200 feet AGL  If weather (WXR) is not selected on either HSI, the weather display, including PWS symbology, will automatically pop-up on the HSI.  PWS symbol on the HSI shows windshear position and size only when the HSI Mode Selector is in the VOR, APP, MAP or CTR MAP mode.

**PWS Inhibits**

PWS alerts are inhibited during takeoff and landing as follows:

- WARNINGS, between 100 knots and 50 feet AGL
- CAUTIONS, between 80 knots and 400 feet AGL

**Note:** These inhibits do not remove existing PWS alerts.

PWS alerts are also inhibited by

- Windshear Immediate-Alert Warnings
- GPWS Immediate-Alert Warnings
- GPWS Look-Ahead Terrain Warnings



---

## Traffic Alert and Collision Avoidance System (TCAS)

TCAS alerts the crew to conflicting traffic. The system identifies a three-dimensional airspace around the airplane where a high likelihood of air traffic conflicts exist. These dimensions depend upon closure rates between the airplane and potentially conflicting traffic.

TCAS interrogates operating transponders in other aircraft, analyzes the replies, predicts flight paths and designates possible conflicting traffic as a "traffic aircraft."

When the system designates a traffic aircraft, TCAS provides the flight crew with a situational display. Additionally, TCAS may provide an aural annunciation and flight path guidance.

**Note:** Other aircraft that do not have an operating transponder can not initiate situational displays, aural annunciations or flight path guidance.

**Note:** TCAS is independent of ground-based air traffic control.

During normal operations, when TCAS designates a traffic aircraft, the system provides the following advisories and displays:

- Resolution Advisories (RA) and Display
- Traffic Advisories (TA) and Displays
- Proximate Traffic and Other Traffic Displays

### Normal Operations

TCAS is enabled from the Transponder Panel. The system is normally operated with the TCAS Mode Selector in the TA/RA mode.

The TA mode may be used:

- during engine out operations to prevent RAs when adequate thrust may not be available to follow the RA commands
- when intentionally operating near other traffic that may cause RAs, such as during parallel approaches or during VFR operations.

### Resolution Advisories (RA) and Displays

A Resolution Advisory (RA) is an immediate-threat prediction that traffic aircraft will enter the TCAS collision airspace within approximately 20 to 30 seconds. If altitude data from the traffic aircraft's transponder is not available, no RA can be provided.

When TCAS issues a RA:

- a voice alert sounds
- vertical guidance is displayed
- symbology is displayed

---

## Voice Alert

When TCAS issues a RA, voice alerts will sound. These voice alerts aurally elaborate on the displayed Vertical Guidance and are described in this Chapter under:

- Voice Annunciations for ADI Guidance

## Vertical Guidance

Vertical guidance is displayed for a traffic-avoidance maneuver. Traffic avoidance is ensured by adjusting or maintaining:

- an ADI pitch attitude outside the displayed red RA regions

**Note:** If the traffic aircraft also has TCAS and an operating mode S transponder, vertical guidance is coordinated with the traffic aircraft.

## Display Symbology

The RA traffic symbol is a filled red square with an accompanying data tag when the traffic aircraft is providing altitude information.

The data tag appears in red and contains the following information about the traffic aircraft:

- a two-digit number preceded with a "+" or a "-" sign and positioned above or below the RA symbol. This number represents, in hundreds of feet, the relative vertical position and altitude difference between the airplane and the traffic aircraft.
- a vertical arrow appears to the right of the RA symbol when the traffic aircraft is either climbing or descending in excess of 500 feet per minute.

The RA is displayed as follows:

### HSI

- When the red TRAFFIC message appears and the traffic aircraft is within the selected display range, the traffic symbol's relative position is displayed.
- When the traffic aircraft is outside the selected range, the red OFFSCALE message appears.
- When TCAS is unable to track the traffic aircraft's bearing, the red RA symbol is displayed below the TRAFFIC message.

## Traffic Advisories (TA) and Displays

A Traffic Advisory (TA) is a prediction that traffic aircraft will enter the TCAS collision airspace within approximately 35 to 40 seconds. TAs are intended to assist the crew in establishing visual contact with the traffic aircraft.

When TCAS issues a TA:

- a voice alert sounds
- symbology is displayed

---

## Voice Alert

When TCAS issues a TA, the Voice Annunciation, TRAFFIC TRAFFIC will sound to aurally alert the crew.

## Display Symbology

The TA traffic symbol is a filled amber circle with an accompanying data tag when the traffic aircraft is providing altitude information.

The data tag appears in amber and contains the following information about the traffic aircraft:

- a two-digit number preceded with a "+" or a "-" sign and positioned above or below the TA symbol. This number represents, in hundreds of feet, the relative vertical position and altitude difference between the airplane and the traffic aircraft.
- a vertical arrow appears to the right of the TA symbol when the traffic aircraft is either climbing or descending in excess of 500 feet per minute.

The TA is displayed as follows:

### HSI

- When the amber TRAFFIC message appears and the traffic aircraft is within the selected display range, the traffic symbol's relative position is displayed.
- When TCAS is unable to track the traffic aircraft's bearing, the amber TA symbol is displayed below the TRAFFIC message.
- When the traffic aircraft is outside the selected range, the amber OFFSCALE message appears.

## Automatic TA and RA Display

TCAS automatically displays RA and TA symbols on the HSI when:

- a RA or TA occurs, and
- neither pilot has pushed the EFIS Traffic (TFC) Switch, and
- the HSI Mode Selector is in the VOR, APP, or MAP mode, and
- the TCAS Mode Selector is in TA/RA or TA

## Proximate Traffic and Other Traffic Displays

Proximate Traffic is a traffic aircraft that is neither a RA nor a TA but is within:

- six miles laterally, and
- 1,200 feet vertically

Other Traffic is a traffic aircraft that is neither a RA, TA, or Proximate Traffic

When TCAS identifies Proximate Traffic or Other Traffic:

- symbology is displayed

## Display Symbology

The Proximate Traffic symbol is a filled diamond and the Other Traffic symbol is a hollow diamond. Both Proximate Traffic and Other Traffic symbols are displayed with an accompanying data tag when the traffic aircraft is providing altitude information.

The data tag contains the following information about the traffic aircraft:

- a two-digit number preceded with a "+" or a "-" sign and positioned above or below the Proximate or Other Traffic symbol. This number represents, in hundreds of feet, the relative vertical position and altitude difference between the airplane and the traffic aircraft.
- a vertical arrow appears to the right of the Proximate or Other Traffic symbol when the traffic aircraft is either climbing or descending in excess of 500 feet per minute.

Proximate Traffic and Other Traffic are displayed as follows:

### HSI

- When Proximate Traffic is within the selected display range, the traffic aircraft's relative position is displayed as a filled white diamond.
- When Other Traffic is within the selected display range, the traffic aircraft's relative position is displayed as an unfilled white diamond.

## TCAS Voice Annunciations

### Voice Annunciations for ADI Guidance

Voice Annunciation	Condition	Response
TRAFFIC, TRAFFIC	TCAS has issued a TA	Attempt to visually locate the traffic
CLIMB, CLIMB	Present ADI pitch attitude is within the red RA regions	Adjust ADI pitch attitude to remain outside the red RA regions
DESCEND, DESCEND	Present ADI pitch attitude is within the red RA regions	Adjust ADI pitch attitude to remain outside the red RA regions
ADJUST VERTICAL SPEED ADJUST	TCAS requires change in pitch attitude Present ADI pitch attitude is within the red RA regions	Adjust ADI pitch attitude to remain outside the red RA regions
MONITOR VERTICAL SPEED	Present ADI pitch attitude is outside the red RA regions	Continue to keep ADI pitch attitude outside the red RA regions

<b>Voice Annunciation</b>	<b>Condition</b>	<b>Response</b>
MAINTAIN VERTICAL SPEED MAINTAIN	Present ADI pitch attitude is outside the red RA regions	Continue to keep ADI pitch attitude outside the red RA regions
CLIMB, CROSSING CLIMB CLIMB, CROSSING CLIMB	Present ADI pitch attitude is within the red RA regions Airplane will climb through the traffic aircraft's altitude	Adjust ADI pitch attitude to remain outside the red RA regions
MAINTAIN VERTICAL SPEED CROSSING MAINTAIN	Present ADI pitch attitude is outside the red RA regions Airplane will pass through the traffic aircraft's altitude	Continue to keep ADI pitch attitude outside the red RA regions
DESCEND, CROSSING DESCEND DESCEND, CROSSING DESCEND	Present ADI pitch attitude is within the red RA regions Airplane will descend through the traffic aircraft's altitude	Adjust ADI pitch attitude to remain outside the red RA regions
INCREASE CLIMB, INCREASE CLIMB	TCAS requires change in pitch attitude	Adjust ADI pitch attitude to remain outside the red RA regions
INCREASE DESCENT, INCREASE DESCENT	Present ADI pitch attitude is within the red RA regions	
CLIMB, CLIMB NOW CLIMB, CLIMB NOW	Previous vertical guidance was to descend Present ADI pitch attitude is within the red RA regions	Climb and adjust ADI pitch attitude to remain outside the red RA regions
DESCEND, DESCEND NOW DESCEND, DESCEND NOW	Previous vertical guidance was to climb Present ADI pitch attitude is within the red RA regions	Descend and adjust ADI pitch attitude to remain outside the red RA regions
ADJUST VERTICAL SPEED ADJUST	Minimum ADI pitch attitude required to ensure separation has decreased Present ADI pitch attitude is outside the red RA regions	Adjust ADI pitch attitude Continue to keep ADI pitch attitude outside the red RA regions

Voice Annunciation	Condition	Response
CLEAR OF CONFLICT	Vertical guidance is no longer displayed and traffic symbology changes to TA  Separation between the airplane and the traffic aircraft is increasing  CLEAR OF CONFLICT will not sound if TCAS can no longer predict the track of the traffic aircraft	Attempt to visually locate the traffic aircraft

### Inhibits

INCREASE DESCENT RAs are inhibited below approximately 1,450 feet radio altitude.

DESCEND RAs are inhibited below approximately 1,100 feet radio altitude.

RAs are inhibited below approximately 1,000 feet radio altitude. Below approximately 1,000 feet when the TA/RA mode is selected on the transponder panel, TA only mode is enabled automatically. All TCAS voice annunciations are inhibited below approximately 500 feet radio altitude.

**Note:** GPWS Immediate-Alert and Windshear Immediate-Alert annunciations inhibit all TCAS alerts.

### Non-Normal Operations

#### HSI Messages

When the HSI message:

- TCAS OFF is displayed, neither TA nor TA/RA is selected with the TCAS Mode Selector. The system cannot display symbology or vertical guidance. Voice Annunciations will not occur.
- TCAS FAIL is displayed, the system cannot display symbology or vertical guidance. Voice Annunciations will not occur.

**Note:** TCAS OFF does not display if TCAS FAIL is annunciated.

---

## EICAS Messages

When the EICAS advisory message:

- TCAS is displayed, the system cannot display symbology or vertical guidance. Voice Annunciations will not occur.
- TCAS OFF is displayed, neither TA nor TA/RA is selected with the TCAS Mode Selector. The system cannot display symbology or vertical guidance. Voice Annunciations will not occur.

**Note:** The TCAS OFF message is inhibited below approximately 400 feet radio altitude.

Intentionally  
Blank



**Warning Systems EICAS Messages**

The following EICAS messages can be displayed.

**GPWS**

Message	Level	Light	Aural	Condition
ALT CALLOUTS	Advisory			Altitude callouts are no longer provided.
GND PROX SYS	Advisory			Ground proximity alerts may not be provided.
TERR OVRD	Advisory	OVRD		Ground proximity terrain override switch is in OVRD.
TERR POS	Advisory			Terrain position data has been lost.
WINDSHEAR SYS	Advisory			Windshear alerts may not be provided.

**TCAS**

Message	Level	Light	Aural	Condition
TCAS	Advisory			TCAS system is inoperative.
TCAS OFF	Advisory			The TCAS system is off. Inhibited below 400 feet radio altitude.

**Configuration**

Message	Level	Light	Aural	Condition
FLAPS	Warning	CONFIG	Siren	Flaps are not in a takeoff position when either engine's thrust is in the takeoff range on the ground.

# DO NOT USE FOR FLIGHT

## 757 Flight Crew Operations Manual

Message	Level	Light	Aural	Condition
GEAR NOT DOWN	Warning	CONFIG	Siren	Any landing gear is not down and locked when either thrust lever is closed below 800 feet radio altitude or when flaps are in a landing position.
PARKING BRAKE	Warning	CONFIG	Siren	Parking brake is set when either engine's thrust is in the takeoff range on the ground.
SPOILERS	Warning	CONFIG	Siren	Speedbrake lever is not DOWN when either engine's thrust is in the takeoff range on the ground.
STABILIZER	Warning	CONFIG	Siren	Stabilizer is not within the greenband when either engine's thrust is in the takeoff range on the ground.

### Miscellaneous

Message	Level	Light	Aural	Condition
ALTITUDE ALERT	Caution	ALT ALERT	Beeper	Airplane has deviated from the selected altitude.
EICAS CONT PANEL	Advisory			EICAS control panel is inoperative.
EICAS DISPLAY	Advisory			One EICAS CRT is inoperative.
OVERSPEED	Warning	OVSPD	Siren	Airspeed has exceeded Vmo/Mmo.
OVERSPEED	Warning	OVSPD	Clacker	Airspeed has exceeded Vmo/Mmo.